



Agilent X-Series Signal Analyzer

**This manual provides documentation for the
following X-Series Analyzers:**

**PXA Signal Analyzer N9030A
MXA Signal Analyzer N9020A
EXA Signal Analyzer N9010A
CXA Signal Analyzer N9000A**

**N6158A & W6158A CMMB
Measurement Application
User's and Programmer's
Reference**



Agilent Technologies

Notices

© Agilent Technologies, Inc. 2008 - 2010

No part of this manual may be reproduced in any form or by any means (including electronic storage and retrieval or translation into a foreign language) without prior agreement and written consent from Agilent Technologies, Inc. as governed by United States and international copyright laws.

Trademark Acknowledgements

Microsoft® is a U.S. registered trademark of Microsoft Corporation.

Windows® and MS Windows® are U.S. registered trademarks of Microsoft Corporation.

Adobe Reader® is a U.S. registered trademark of Adobe System Incorporated.

Java™ is a U.S. trademark of Sun Microsystems, Inc.

MATLAB® is a U.S. registered trademark of Math Works, Inc.

Norton Ghost™ is a U.S. trademark of Symantec Corporation.

Manual Part Number

N6158-90001

Print Date

July 2010

Printed in USA

Agilent Technologies, Inc.
1400 Fountaingrove Parkway
Santa Rosa, CA 95403

Warranty

The material contained in this document is provided “as is,” and is subject to being changed, without notice, in future editions. Further, to the maximum extent permitted by applicable law, Agilent disclaims all warranties, either express or implied, with regard to this manual and any information contained herein, including but not limited to the implied warranties of merchantability and fitness for a particular purpose. Agilent shall not be liable for errors or for incidental or consequential damages in connection with the furnishing, use, or performance of this document or of any information contained herein. Should Agilent and the user have a separate written agreement with warranty terms covering the material in this document that conflict with these terms, the warranty terms in the separate agreement shall control.

Technology Licenses

The hardware and/or software described in this document are furnished under a license and may be used or copied only in accordance with the terms of such license.

Restricted Rights Legend

If software is for use in the performance of a U.S. Government prime contract or subcontract, Software is delivered and

licensed as “Commercial computer software” as defined in DFAR 252.227-7014 (June 1995), or as a “commercial item” as defined in FAR 2.101(a) or as “Restricted computer software” as defined in FAR 52.227-19 (June 1987) or any equivalent agency regulation or contract clause. Use, duplication or disclosure of Software is subject to Agilent Technologies’ standard commercial license terms, and non-DOD Departments and Agencies of the U.S. Government will receive no greater than Restricted Rights as defined in FAR 52.227-19(c)(1-2) (June 1987). U.S. Government users will receive no greater than Limited Rights as defined in FAR 52.227-14 (June 1987) or DFAR 252.227-7015 (b)(2) (November 1995), as applicable in any technical data.

Safety Notices

CAUTION

A CAUTION notice denotes a hazard. It calls attention to an operating procedure, practice, or the like that, if not correctly performed or adhered to, could result in damage to the product or loss of important data. Do not proceed beyond a CAUTION notice until the indicated conditions are fully understood and met.

WARNING

A WARNING notice denotes a hazard. It calls attention to an operating procedure, practice, or the like that, if not correctly performed or adhered to, could result in personal injury or death. Do not proceed beyond a WARNING notice until the indicated conditions are fully understood and met.

Warranty

This Agilent technologies instrument product is warranted against defects in material and workmanship for a period of one year from the date of shipment. During the warranty period, Agilent Technologies will, at its option, either repair or replace products that prove to be defective.

For warranty service or repair, this product must be returned to a service facility designated by Agilent Technologies. Buyer shall prepay shipping charges to Agilent Technologies and Agilent Technologies shall pay shipping charges to return the product to Buyer. However, Buyer shall pay all shipping charges, duties, and taxes for products returned to Agilent Technologies from another country.

Where to Find the Latest Information

Documentation is updated periodically. For the latest information about this analyzer, including firmware upgrades, application information, and product information, see the following URLs:

<http://www.agilent.com/find/pxa>

<http://www.agilent.com/find/mxa>

<http://www.agilent.com/find/exa>

<http://www.agilent.com/find/cxa>

To receive the latest updates by email, subscribe to Agilent Email Updates:

<http://www.agilent.com/find/emailupdates>

Information on preventing analyzer damage can be found at:

<http://www.agilent.com/find/tips>

1. Using Help

Locating Other Help Resources	86
Viewing Help on a separate Computer	87
Copying the HTML Help (CHM) Files	87
Copying the Acrobat (PDF) Files	88
How Help is Organized.	90
Help Contents Listing	90
System Functions	90
Key Descriptions for Each Measurement	91
Key Information for Softkeys	91
Common Measurement Functions	92
Front Panel Keys used by the Help System	93
Navigating Windows HTML Help (CHM) Files	94
HTML Help Window Components.	94
Basic Help Window Operations	95
Navigating the Help Window	96
Navigating Acrobat (PDF) Files	102
Adobe Reader Window	102
Printing Acrobat Files	103
Terms Used in This Documentation	105
Terms used in Key Parameter Tables	105
Context Sensitive Help not Available.	107
Finding a Topic without a Mouse and Keyboard	107
Selecting a Hyperlink without a Mouse	108

2. About the Analyzer

Installing Application Software	110
Viewing a License Key	110
Obtaining and Installing a License Key	110
Missing and Old Measurement Application Software	111
X-Series Options and Accessories	112
Front-Panel Features	113
Overview of key types.	116
Display Annotations	119
Rear-Panel Features	121
Window Control Keys	124
Multi-Window	124
Zoom	124
Next Window	125
Mouse and Keyboard Control.	126
Right-Click	126
PC Keyboard	127
Instrument Security & Memory Volatility	131

3. About the N6158A CMMB Measurement Application

What Does the CMMB Measurement Application Do?	134
--	-----

4. Programming the Analyzer

Contents

What Programming Information is Available?	136
IEEE Common GPIB Commands	137
Calibration Query	137
Clear Status	137
Standard Event Status Enable	137
Standard Event Status Register Query	138
Identification Query	138
Instrument Model Number	139
Operation Complete	139
Query Instrument Options	139
Recall Instrument State	140
Save Instrument State	140
Service Request Enable	141
Status Byte Query	141
Trigger	141
Self Test Query	142
Wait-to-Continue	142

5. System Functions

File	144
File Explorer	144
Page Setup	145
Print	146
Exit	146
Preset	147
Mode Preset	147
Restore Mode Defaults	149
*RST (Remote Command Only)	149
Print	150
Quick Save	151
Recall	153
State	153
Trace (+State)	157
Data (Import)	160
Open...	165
File Open Dialog and Menu	166
Save	170
State	170
Trace (+State)	173
Data (Export)	177
Screen Image	181
Save As	185
Mass Storage Catalog (Remote Command Only)	188
Mass Storage Change Directory (Remote Command Only)	188
Mass Storage Copy (Remote Command Only)	188
Mass Storage Delete (Remote Command Only)	189
Mass Storage Data (Remote Command Only)	189
Mass Storage Make Directory (Remote Command Only)	190
Mass Storage Move (Remote Command Only)	190

Mass Storage Remove Directory (Remote Command Only)	190
System.	191
Show	191
Power On.	199
Alignments	207
I/O Config	232
Restore Defaults	275
Control Panel.	280
Licensing.	281
Security	284
Diagnostics	285
Service.	288
System Remote Commands (Remote Commands Only)	288
User Preset	291
User Preset.	291
User Preset All Modes.	292
Save User Preset	293

6. Channel Power Measurement

AMPTD Y Scale	300
Ref Value	300
Attenuation	301
Scale/Div	301
Presel Center.	302
Presel Adjust.	302
Y Axis Unit.	302
Reference Level Offset	302
μ W Path Control	303
Internal Preamp	303
Ref Position	303
Auto Scaling	304
Auto Couple	305
BW	306
Res BW	306
Video BW	307
Filter Type	309
Cont.	310
FREQ Channel	311
Input/Output	312
Marker.	313
Select Marker	313
Marker Type	313
Marker X Axis Value (Remote Command Only)	314
Marker X Axis Position (Remote Command Only)	314
Marker Y Axis Value (Remote Command only)	315
Properties.	315
Couple Markers	317
All Markers Off.	318
Backward Compatibility SCPI Commands.	318

Contents

Marker Function	320
Marker To	321
Meas	322
Meas Setup	323
Avg/Hold Num	323
Avg Mode	324
Integ BW	325
PhNoise Opt	326
IF Gain	327
RRC Filter	329
Filter BW	329
Filter Alpha	330
PSD Unit	331
Meas Preset	332
Shoulder Offset Start (Only for DVB-T/H and ISDB-T mode)	332
Shoulder Offset Stop (Only for DVB-T/H and ISDB-T mode)	332
Shoulder Offset (Only for DTMB (CTTB) and CMMB mode)	333
Mode	335
Mode Setup	336
Peak Search	337
Recall	338
Restart	339
Save	340
Single	341
Source	342
Span X Scale	343
Span	343
Full Span	344
Last Span	345
Sweep/Control	346
Sweep Time	346
Sweep Setup	347
Pause	348
Gate	348
Points	348
Trace/Detector	350
Trace Type	350
Detector	350
Trigger	353
View/Display	354
Display	356
Bar Graph	356
RF Spectrum (Only for DVB-T/H, DTMB (CTTB), ISDB-T and CMMB)	357
Shoulder Attenuation (Only for DVB-T/H, DTMB (CTTB), ISDB-T and CMMB)	359
Spectrum Mask(DTMB (CTTB), DVB-T/H only)	362
7. ACP Measurement	
AMPTD Y Scale	378
Ref Value	378

Contents

Attenuation	379
Scale/Div	379
Presel Center	379
Presel Adjust	380
Y Axis Unit	380
Reference Level Offset	380
μ W Path Control	380
Internal Preamplifier	381
Ref Position	381
Auto Scaling	381
Auto Couple	383
BW	384
Res BW	384
Video BW	385
RBW Control	387
Cont.	389
FREQ Channel	390
Input/Output	391
Marker	392
Select Marker	392
Marker Type	392
Marker X Axis Value (Remote Command only)	393
Marker X Axis Position (Remote Command only)	394
Marker Y Axis Value (Remote Command only)	394
Properties	395
Couple Markers	397
Marker All Off	397
Backward Compatibility SCPI Commands	398
Marker Function	399
Marker To	400
Meas	401
Meas Setup	402
Average/Hold Number	402
Avg Mode	403
Carrier Setup	403
Offset/Limits	415
Carrier Result	436
PhNoise Opt	436
Meas Method	438
Meas Type	440
Limit Test	441
Noise Correction	442
Meas Preset	442
Offset RRC Weighting (Backward Compatibility SCPI)	444
Offset Filter Alpha (Backward Compatibility SCPI)	444
Method for Carrier (Backward Compatibility SCPI)	445
Mode	447
Mode Setup	448
Peak Search	449

Peak Search	449
Next Peak	449
Next Pk Right	449
Next Pk Left	450
Marker Delta	450
Pk-Pk Search	450
Min Search	451
Recall	452
State	452
Data	452
Restart	453
Save	454
Single	455
Source	456
SPAN X Scale	457
Span	457
Full Span	458
Last Span	459
Sweep/Control	460
Sweep Time	460
Sweep Setup	462
Pause	462
Gate	462
Points	463
Trace/Detector	465
Select Trace (front panel only)	465
Trace Type	465
View / Blank	466
Detector	467
Trigger	471
View/Display	472
Display	476
Bar Graph	476

8. Power Stat CCDF Measurement

AMPTD Y Scale	482
Attenuation	482
Range	482
Presel Center	482
Presel Adjust	483
Y Axis Unit	483
Reference Level Offset	483
μ W Path Control	483
Internal Preamp	484
Auto Couple	485
BW	486
Info BW	486
Cont	488
FREQ Channel	489

Input/Output	490
Marker	491
Select Marker	491
Marker Type	491
Marker X Axis Value (Remote Command Only)	492
Marker Y Axis Value (Remote Command Only)	493
Properties	493
Couple Markers	495
All Markers Off	495
Marker To	496
Marker Function	497
Meas	498
Meas Setup	499
Counts	499
Meas Cycles	499
Meas Interval (When the application is NOT CDMA1xEVDO)	500
Meas Interval (CDMA1xEVDO Only)	501
Meas Offset (CDMA1xEVDO Only)	502
IF Gain	502
Meas Preset	504
Mode	505
Mode Setup	506
Peak Search	507
Recall	508
Restart	509
Save	510
Single	511
Source	512
Span X Scale	513
Scale/Div	513
Sweep/Control	514
Pause/Resume	514
Trace/Detector	515
Store Ref Trace	515
Ref Trace	515
Gaussian Line	516
Trigger	517
View/Display	518
Display	520
Slot View (TD-SCDMA only)	521

9. Spectrum Emission Mask Measurement

AMPTD Y Scale	534
Ref Value	534
Attenuation	535
Scale/Div	535
Presel Center	535
Presel Adjust	536
Y Axis Unit	536

Contents

Reference Level Offset	536
μW Path Control	536
Internal Preamp	536
Ref Position	537
Auto Scaling	537
Auto Couple	539
BW	540
Filter Type	540
Cont	541
FREQ Channel	542
Input/Output	543
Marker	544
Select Marker	544
Marker Type	544
Marker X Axis Value (Remote Command only)	545
Marker X Axis Position (Remote Command only)	545
Marker Y Axis Value (Remote Command only)	546
Couple Markers	547
All Markers Off	547
Marker Function	548
Marker To	549
Meas	550
Meas Setup	551
Avg/Hold Num	551
Meas Type	552
Ref Channel	552
Power Ref	559
Offsets/Limit	562
Method	583
Filter Alpha	584
Meas Preset	585
Limits State(Only for TD-SCDMA)	585
Limit Type (Only for DVB-T/H)	586
Limit Type (Only for ISDB-T)	587
Offset Frequency Define	593
Mode	596
Mode Setup	597
Peak Search	598
Recall	599
State	599
Data	599
Restart	600
Save	601
Single	602
Source	603
Span X Scale	604
Sweep/Control	605
Pause	605
Gate	605

Trace/Detector	606
Trace Type	606
Chan Detector	606
Offset Detector	608
Trigger	611
View/Display	612
Display	614
Abs Pwr Freq	614
Rel Pwr Freq	619
Integrated Power	624
Limit Lines	629

10. Mod Accuracy Measurement

Amplitude (AMPTD) Y Scale	636
Ref Value	636
Attenuation	640
Range	640
Scale/Div	640
Presel Center	645
Presel Adjust	645
Scale Type	645
Internal Preamp	646
Ref Position	646
Auto Scaling	649
Auto Couple	653
BW	654
Cont.	655
FREQ Channel	656
Input/Output	657
Marker	658
Select Marker	658
Marker Type	658
Marker X Axis Value (Remote Command only)	659
Marker X Axis Position (Remote Command only)	660
Marker Y Axis Value (Remote Command only)	660
Properties	661
Couple Markers	662
All Markers Off	663
Marker Function	664
Marker To	665
Meas	666
Meas Setup	667
Avg/Hold Num	667
Avg Mode	667
Meas Type	668
PLCH Settings	669
Timeslot Settings	670
Advanced	672
Meas Preset	677

Contents

Mode	678
Mode Setup	679
Peak Search	680
Next Peak	680
Next Pk Right	680
Next Pk Left	681
Marker Delta	681
Peak Criteria	681
Peak Table	684
Pk-Pk Search	687
Min Search	687
Recall	689
Restart	690
Save	691
Single	692
Source	693
SPAN X Scale	694
Ref Value	694
Scale/Div	698
Ref Position	703
Auto Scaling	705
Scale Type	709
Sweep/Control	710
Trace/Detector	711
Trigger	712
View/Display	713
Display	714
I/Q Measured Polar Graph	714
I/Q Error	718
Channel Frequency Response	724
Channel Impulse Response	726
Spectral Flatness	728
MER vs. Timeslot Graph	729
Result Metrics	730
View Selection by number (Remote Command SCPI only)	733

11. Occupied Bandwidth Measurement

AMPTD Y Scale	737
Ref Value	737
Attenuation	738
Scale/Div	738
Presel Center	738
Presel Adjust	739
Y Axis Unit	739
Reference Level Offset	739
μ W Path Control	739
Internal Preamp	740
Ref Position	740
Auto Scaling	740

Contents

Auto Couple	742
BW	743
Res BW	743
Video BW	744
Filter Type	746
Cont (Continuous)	747
FREQ/Channel (Frequency or Channel)	748
Input/Output	749
Marker	750
Select Marker	750
Marker X Axis Value (Remote Command only)	750
Marker X Axis Position (Remote Command only)	751
Marker Y Axis Value (Remote Command only)	751
Marker Type	752
Properties	752
All Markers Off	753
Backward Compatibility SCPI Commands	754
Marker Function	755
Marker To	756
Meas	757
Meas Setup	758
Avg/Hold Num	758
Avg Mode	759
Max Hold (Remote Command Only)	759
Occ BW % Pwr	760
x dB	761
IF Gain	762
Limit	763
Meas Preset	764
Mode	766
Mode Setup	767
Peak Search	768
Recall	769
Restart	770
Save	771
Single	772
Source	773
Span X Scale	774
Span	774
Full Span	775
Last Span	775
Sweep/Control	777
Sweep Time	777
Sweep Setup	778
Pause	779
Gate	779
Points	779
Trace/Detector	781
Trace Type	781

Contents

Detector.....	781
Trigger.....	785
View/Display.....	786
Display.....	789

12. Monitor Spectrum

AMPTD Y Scale.....	792
Ref Value.....	792
Attenuation.....	792
Scale/Div.....	793
Presel Center.....	793
Presel Adjust.....	793
μ W Path Control.....	793
Internal Preamp.....	794
Ref Position.....	794
Auto Scaling.....	794
Auto Couple.....	796
BW.....	797
Res BW.....	797
Video BW.....	799
VBW:3dB RBW.....	801
Span:3dB RBW.....	801
Cont.....	803
FREQ Channel.....	804
Input/Output.....	805
Marker.....	806
Select Marker.....	806
Marker Type.....	806
Properties.....	808
Select Marker.....	808
Couple Markers.....	810
All Markers Off.....	810
Marker Function.....	811
Select Marker.....	811
Marker Function Type.....	811
Band Adjust.....	811
Marker To.....	814
Meas.....	815
Meas Setup.....	816
Avg/Hold Num.....	816
Avg Mode.....	816
Meas Preset.....	817
Mode.....	818
Mode Setup.....	819
Peak Search.....	820
Recall.....	821
Restart.....	822
Save.....	823
Single.....	824

Source	825
Span X Scale	826
Span	826
Full Span	827
Last Span	827
Sweep/Control	829
Sweep Time	829
Pause	829
Gate	830
Points	830
Trace/Detector	831
Select Trace	831
Trace Type	831
Update	832
Display	832
Detector	833
Clear Trace	835
Clear All Traces	835
Trigger	836
View/Display	837
Display	838

13. Waveform Measurement

AMPTD Y Scale	841
Ref Value	841
Attenuation	842
Range	843
Scale/Div	843
Presel Center	844
Presel Adjust	845
Internal Preamp	845
Ref Position	845
Auto Scaling	846
Auto Couple	848
BW	849
Digital IF BW	849
Filter Type	850
Filter Type Bwcc	851
Filter	860
Channel Filter Bandwidth Bwcc (Remote Command Only)	860
Channel Filter Alpha	861
Cont.	862
FREQ Channel	863
Input/Output	864
Marker	865
Select Marker	865
Marker Type	865
Marker X Axis Value (Remote Command Only)	866
Marker X Axis Position (Remote Command Only)	867

Marker Y Axis Value (Remote Command Only)	868
Properties	868
Couple Markers.	870
All Markers Off.	870
Backward Compatibility SCPI Commands	871
Marker Function	872
Select Marker	872
Marker Function Type.	872
Band Adjust	873
Marker To.	876
Meas	877
Meas Setup	878
Average/Hold Num.	878
Avg Mode	878
Avg Type.	879
HW Averaging	880
Time Avg Num	880
Sample Rate	881
Sample Period (Aperture) Setting (Remote Command Only)	881
Meas Time.	882
Meas Preset.	882
Advanced	883
Mode.	887
Mode Setup.	888
Peak Search	889
Next Peak	889
Min Search	889
Recall	891
Restart.	892
Save	893
Single	894
Source.	895
SPAN X Scale.	896
Ref Value.	896
Scale/Div.	896
Ref Position	897
Auto Scaling	898
Sweep/Control	899
Pause and Resume	899
Trace/Detector	900
Trigger	901
View/Display	902
Display	903
RF Envelope	903
I/Q Waveform	905
14. Common Measurement Functions	
AMPTD Y Scale.	909
Reference Level	909

Contents

Attenuation	910
Range.	919
Scale / Div	925
Scale Type	925
Presel Center	926
Preselector Adjust	927
Y Axis Unit	929
Reference Level Offset	934
μ W Path Control	935
Internal Preamp	939
Auto Couple	943
BW	945
Res BW	945
Video BW	947
VBW:3dB RBW	948
Span:3dB RBW	950
RBW Control.	951
Cont (Continuous Measurement/Sweep)	957
FREQ Channel	959
Channel	959
Center Freq	959
Chan Step	962
CF Step	962
Channel Table	963
Input/Output	969
RF Input.	970
I/Q	971
RF Calibrator.	999
External Gain	1001
Restore Input/Output Defaults	1005
Data Source	1006
Corrections	1010
Freq Ref In	1021
Output Config	1027
Marker.	1039
Select Marker	1042
Normal	1042
Delta	1043
Fixed	1043
Off	1044
Properties.	1045
Marker Table	1052
Marker Count	1052
Couple Markers	1056
All Markers Off	1057
Marker Function	1059
Select Marker	1060
Marker Noise	1060
Band/Interval Power	1062

Band/Interval Density	1062
Marker Function Off	1064
Band Adjust	1064
Measure at Marker	1068
Marker To	1079
Mkr->CF	1079
Mkr->CF Step	1080
Mkr->Start	1080
Mkr->Stop	1081
Mkr Δ ->Span	1081
Mkr Δ ->CF	1082
Mkr->Ref Lvl	1082
Meas	1083
Remote Measurement Functions	1083
Meas Setup	1097
Average/Hold Number	1097
Average Type	1098
N dB Points	1101
PhNoise Opt	1105
ADC Dither	1108
Swept IF Gain	1110
FFT IF Gain	1112
Analog Demod Tune & Listen	1114
Noise Source	1120
Meas Preset	1122
Mode	1123
Application Mode Number Selection (Remote Command Only)	1125
Application Mode Catalog Query (Remote Command Only)	1126
Application Identification (Remote Commands Only)	1126
Application Identification Catalog (Remote Commands Only)	1128
Mode Setup	1141
Device Type	1141
Noise Reduction	1143
Restore Mode Defaults	1144
Peak Search	1145
Next Peak	1145
Next Pk Right	1146
Next Pk Left	1146
Marker Delta	1147
Mkr->CF	1147
Mkr->Ref Lvl	1147
Peak Criteria	1147
Peak Table	1152
Continuous Peak Search	1156
Pk-Pk Search	1157
Min Search	1158
Peak Data Query (RemoteCommand Only)	1158
Recall	1159
Amplitude Correction	1159

Contents

Restart	1163
Save	1165
Amplitude Correction	1165
Single (Single Measurement/Sweep)	1169
Source	1171
Span X-Scale	1173
Span	1173
Full Span	1175
Zero Span	1175
Last Span	1177
Signal Track (Span Zoom)	1177
Sweep/Control	1181
Sweep Time	1181
Sweep Setup	1183
Pause/Resume	1193
Gate	1194
Points	1207
Abort (Remote Command Only)	1208
Trace/Detector	1211
Select Trace	1213
Clear Write	1214
Trace Average	1214
Max Hold	1215
Min Hold	1216
View/Blank	1217
Detector	1220
Preset Detectors	1230
Clear Trace	1231
Clear All Traces	1232
Math	1232
Normalize	1239
Copy/Exchange	1245
Send/Query Trace Data (Remote Command Only)	1247
Format Data: Numeric Data (Remote Command Only)	1248
Format Data: Byte Order (Remote Command Only)	1249
Smooth Trace Data (Remote Command Only)	1249
Number of Points for Smoothing (Remote Command Only)	1249
Mean Trace Data (Remote Command Only)	1250
Calculate/Compress Trace Data Query (Remote Command Only)	1250
Calculate Data Query (Remote Command Only)	1250
Trigger	1251
Free Run	1260
Video (IF Envelope)	1260
Line	1263
External 1	1265
External 2	1268
RF Burst	1270
Periodic Timer (Frame Trigger)	1275
LXI Trigger	1282

Contents

Baseband I/Q	1298
Auto/Holdoff	1308
Trigger Offset (Remote Command Only)	1311
View/Display	1313
Display	1313
Full Screen	1321
Display Enable (Remote Command Only)	1322

A. Appendix A: Channel Identification Plans

NTSC channels	1324
NTSC-M	1325
NTSC-J	1334
NTSC-Brazil	1340
PAL Channels	1343
PAL-M	1343
PAL-I	1343
PAL-B/G	1344
PAL-D/K (8 MHz)	1359

List of Commands

*CAL?	216
*CLS	137
*ESE <integer>	137
*ESE?	137
*ESR?	138
*IDN?	139
*OPC?	139
*OPC	139
*OPT?	140
*RCL <register #>	140
*RST	149
*SAV <register #>	140
*SRE <integer>	141
*SRE?	141
*STB?	141
*TRG	141
*TST?	142
*WAI	142
:ABORt	1208
:CALCulate:ACPower:LIMit:STATe OFF ON 0 1	441
:CALCulate:ACPower:LIMit:STATe?	441
:CALCulate:ACPower:MARKer:AOff	397
:CALCulate:ACPower:MARKer:COUPle[:STATe] ON OFF 1 0	397
:CALCulate:ACPower:MARKer:COUPle[:STATe]?	397
:CALCulate:ACPower:MARKer[1] 2 3 4 5 6 7 8 9 10 11 12:MAXimum	449
:CALCulate:ACPower:MARKer[1] 2 3 4 5 6 7 8 9 10 11 12:MAXimum:LEFT	450
:CALCulate:ACPower:MARKer[1] 2 3 4 5 6 7 8 9 10 11 12:MAXimum:NEXT	449
:CALCulate:ACPower:MARKer[1] 2 3 4 5 6 7 8 9 10 11 12:MAXimum:RIGHT	450
:CALCulate:ACPower:MARKer[1] 2 3 4 5 6 7 8 9 10 11 12:MINimum	451
:CALCulate:ACPower:MARKer[1] 2 3 4 5 6 7 8 9 10 11 12:MODE POSition DELTA OFF	392
:CALCulate:ACPower:MARKer[1] 2 3 4 5 6 7 8 9 10 11 12:MODE?	392

List of Commands

:CALCulate:ACPower:MARKer[1] 2 3 4 5 6 7 8 9 10 11 12:PTPeak	450
:CALCulate:ACPower:MARKer[1] 2 3 4 5 6 7 8 9 10 11 12:REFerence <integer>	395
:CALCulate:ACPower:MARKer[1] 2 3 4 5 6 7 8 9 10 11 12:REFerence?	395
:CALCulate:ACPower:MARKer[1] 2 3 4 5 6 7 8 9 10 11 12:STATe OFF ON 0 1	398
:CALCulate:ACPower:MARKer[1] 2 3 4 5 6 7 8 9 10 11 12:STATe?	398
:CALCulate:ACPower:MARKer[1] 2 3 4 5 6 7 8 9 10 11 12:TRACe 1 2 3	396
:CALCulate:ACPower:MARKer[1] 2 3 4 5 6 7 8 9 10 11 12:TRACe?	396
:CALCulate:ACPower:MARKer[1] 2 3 4 5 6 7 8 9 10 11 12:X <freq>	393
:CALCulate:ACPower:MARKer[1] 2 3 4 5 6 7 8 9 10 11 12:X:POSition <real>	394
:CALCulate:ACPower:MARKer[1] 2 3 4 5 6 7 8 9 10 11 12:X:POSition?	394
:CALCulate:ACPower:MARKer[1] 2 3 4 5 6 7 8 9 10 11 12:X?	393
:CALCulate:ACPower:MARKer[1] 2 3 4 5 6 7 8 9 10 11 12:Y?	394
:CALCulate:ACPower:OFFSet:LIST:LIMit:NEGative[:UPPer]:DATA <real>, <real>, <real>, <real>, <real>, <real>	429
:CALCulate:ACPower:OFFSet:LIST:LIMit:NEGative[:UPPer]:DATA?	429
:CALCulate:ACPower:OFFSet:LIST:LIMit:POSitive[:UPPer]:DATA <real>, <real>, <real>, <real>, <real>, <real>	428
:CALCulate:ACPower:OFFSet:LIST:LIMit:POSitive[:UPPer]:DATA?	428
:CALCulate:BWIDth BANDwidth:NDB <rel_ampl>	1102
:CALCulate:BWIDth BANDwidth:NDB?	1102
:CALCulate:BWIDth BANDwidth:RESult?	1102
:CALCulate:BWIDth BANDwidth[:STATe] OFF ON 0 1	1102
:CALCulate:BWIDth BANDwidth[:STATe]?	1102
:CALCulate:CHPower:MARKer:AOFF	318
:CALCulate:CHPower:MARKer:COUPle[:STATe] ON OFF 1 0	318
:CALCulate:CHPower:MARKer:COUPle[:STATe]?	318
:CALCulate:CHPower:MARKer[1] 2 3 4 5 6 7 8 9 10 11 12:MAXimum	337
:CALCulate:CHPower:MARKer[1] 2 3 4 5 6 7 8 9 10 11 12:MODE POSition DELTA OFF	313
:CALCulate:CHPower:MARKer[1] 2 3 4 5 6 7 8 9 10 11 12:MODE?	313
:CALCulate:CHPower:MARKer[1] 2 3 4 5 6 7 8 9 10 11 12:REFerence <integer>	316
:CALCulate:CHPower:MARKer[1] 2 3 4 5 6 7 8 9 10 11 12:REFerence?	316
:CALCulate:CHPower:MARKer[1] 2 3 4 5 6 7 8 9 10 11 12:STATe OFF ON 0 1	318

List of Commands

:CALCulate:CHPower:MARKer[1] 2 3 4 5 6 7 8 9 10 11 12:STATe?	318
:CALCulate:CHPower:MARKer[1] 2 3 4 5 6 7 8 9 10 11 12:TRACe RFSpectrum LSHoulder RSoulder MASK	317
:CALCulate:CHPower:MARKer[1] 2 3 4 5 6 7 8 9 10 11 12:TRACe RFSpectrum LSHoulder RSoulder	317
:CALCulate:CHPower:MARKer[1] 2 3 4 5 6 7 8 9 10 11 12:TRACe?.	317
:CALCulate:CHPower:MARKer[1] 2 3 4 5 6 7 8 9 10 11 12:TRACe?.	317
:CALCulate:CHPower:MARKer[1] 2 3 4 5 6 7 8 9 10 11 12:X <real>.	314
:CALCulate:CHPower:MARKer[1] 2 3 4 5 6 7 8 9 10 11 12:X:POSition <real>.	315
:CALCulate:CHPower:MARKer[1] 2 3 4 5 6 7 8 9 10 11 12:X:POSition?.	315
:CALCulate:CHPower:MARKer[1] 2 3 4 5 6 7 8 9 10 11 12:X?	314
:CALCulate:CHPower:MARKer[1] 2 3 4 5 6 7 8 9 10 11 12:Y?	315
:CALCulate:CLIMits:FAIL?	1087
:CALCulate:DATA<n>:COMPRESS? BLOCK CFIT MAXimum MINimum MEAN DMEan RMS RM-SCubed SAMPLE SDEVIation PPHase [,<soffset>[,<length>[,<roffset>[,<rlimit>]]]]	1088
:CALCulate:DATA[1] 2 3 4 5 6:PEAKs? <threshold>,<excursion>[,AMPLitude FREQuency TIME[,ALL GTD-Line LTDLine]].	1093
:CALCulate:DATA[1] 2 3 4 5 6:PEAKs? <threshold>,<excursion>[,AMPLitude FREQuency TIME]	1093
:CALCulate:DATA[n]?.	1087
:CALCulate:EVM:MARKer:AOFF.	663
:CALCulate:EVM:MARKer:COUple[:STATe] OFF ON 0 1.	662
:CALCulate:EVM:MARKer:COUple[:STATe]?	662
:CALCulate:EVM:MARKer:PEAK:EXCursion <rel_ampl>	682
:CALCulate:EVM:MARKer:PEAK:EXCursion:STATe OFF ON 0 1	682
:CALCulate:EVM:MARKer:PEAK:EXCursion:STATe?	682
:CALCulate:EVM:MARKer:PEAK:EXCursion?	682
:CALCulate:EVM:MARKer:PEAK:LIMit <real>.	687
:CALCulate:EVM:MARKer:PEAK:LIMit:STATe OFF ON 0 1	687
:CALCulate:EVM:MARKer:PEAK:LIMit:STATe?	687
:CALCulate:EVM:MARKer:PEAK:LIMit?	687
:CALCulate:EVM:MARKer:PEAK:SORT TIME AMPLitude	686
:CALCulate:EVM:MARKer:PEAK:SORT?	686
:CALCulate:EVM:MARKer:PEAK:TABLE:STATe OFF ON 0 1	685

List of Commands

:CALCulate:EVM:MARKer:PEAK:TABLE:STATe?	685
:CALCulate:EVM:MARKer:PEAK:THReshold <real>	683
:CALCulate:EVM:MARKer:PEAK:THReshold:STATe OFF ON 0 1	683
:CALCulate:EVM:MARKer:PEAK:THReshold:STATe?	683
:CALCulate:EVM:MARKer:PEAK:THReshold?	683
:CALCulate:EVM:MARKer[1] 2 3 4 5 6 7 8 9 10 11 12:MAXimum	680
:CALCulate:EVM:MARKer[1] 2 3 4 5 6 7 8 9 10 11 12:MAXimum:LEFT	681
:CALCulate:EVM:MARKer[1] 2 3 4 5 6 7 8 9 10 11 12:MAXimum:NEXT	680
:CALCulate:EVM:MARKer[1] 2 3 4 5 6 7 8 9 10 11 12:MAXimum:RIGHT	680
:CALCulate:EVM:MARKer[1] 2 3 4 5 6 7 8 9 10 11 12:MINimum	688
:CALCulate:EVM:MARKer[1] 2 3 4 5 6 7 8 9 10 11 12:MODE POSition DELTA OFF	658
:CALCulate:EVM:MARKer[1] 2 3 4 5 6 7 8 9 10 11 12:MODE?	658
:CALCulate:EVM:MARKer[1] 2 3 4 5 6 7 8 9 10 11 12:PTPeak	687
:CALCulate:EVM:MARKer[1] 2 3 4 5 6 7 8 9 10 11 12:REFerence <integer>	661
:CALCulate:EVM:MARKer[1] 2 3 4 5 6 7 8 9 10 11 12:REFerence?	661
:CALCulate:EVM:MARKer[1] 2 3 4 5 6 7 8 9 10 11 12:TRACe POLar MVCARRIER AVCARRIER PVCARRIER GDVCARRIER AVTime	662
:CALCulate:EVM:MARKer[1] 2 3 4 5 6 7 8 9 10 11 12:TRACe?	662
:CALCulate:EVM:MARKer[1] 2 3 4 5 6 7 8 9 10 11 12:X <real>	659
:CALCulate:EVM:MARKer[1] 2 3 4 5 6 7 8 9 10 11 12:X:POSition <real>	660
:CALCulate:EVM:MARKer[1] 2 3 4 5 6 7 8 9 10 11 12:X:POSition?	660
:CALCulate:EVM:MARKer[1] 2 3 4 5 6 7 8 9 10 11 12:X?	659
:CALCulate:EVM:MARKer[1] 2 3 4 5 6 7 8 9 10 11 12:Y?	660
:CALCulate:MAMarker:COUpling ON OFF 1 0	1077
:CALCulate:MAMarker:COUpling?	1077
:CALCulate:MAMarker:DETECTOR[1] 2 3 OFF NORMAL AVERAGE POSITIVE SAMPLE NEGATIVE QPEAK EAVERAGE RAVERAGE	1073
:CALCulate:MAMarker:DETECTOR[1] 2 3:DWELl <dwel time>	1073
:CALCulate:MAMarker:DETECTOR[1] 2 3:DWELl?	1073
:CALCulate:MAMarker:DETECTOR[1] 2 3?	1073
:CALCulate:MAMarker:PCENter ON OFF 1 0	1077
:CALCulate:MAMarker:PCENter?	1077

List of Commands

:CALCulate:MARKer:AOff	1057
:CALCulate:MARKer:COUple[:STATe] OFF ON 0 1	1056
:CALCulate:MARKer:COUple[:STATe]?	1056
:CALCulate:MARKer:PEAK:EXCursion <rel_ampl>	1150
:CALCulate:MARKer:PEAK:EXCursion:STATe OFF ON 0 1	1150
:CALCulate:MARKer:PEAK:EXCursion:STATe?	1150
:CALCulate:MARKer:PEAK:EXCursion?	1150
:CALCulate:MARKer:PEAK:SEARch:MODE MAXimum PARAmeter	1148
:CALCulate:MARKer:PEAK:SEARch:MODE?	1148
:CALCulate:MARKer:PEAK:SORT FREQUency AMPLitude	1153
:CALCulate:MARKer:PEAK:SORT?	1153
:CALCulate:MARKer:PEAK:TABLE:READout ALL GTDLine LTDLine	1154
:CALCulate:MARKer:PEAK:TABLE:READout?	1154
:CALCulate:MARKer:PEAK:TABLE:STATe OFF ON 0 1	1153
:CALCulate:MARKer:PEAK:TABLE:STATe?	1153
:CALCulate:MARKer:PEAK:THReshold <ampl>	1151
:CALCulate:MARKer:PEAK:THReshold:STATe OFF ON 0 1	1151
:CALCulate:MARKer:PEAK:THReshold:STATe?	1151
:CALCulate:MARKer:PEAK:THReshold?	1151
:CALCulate:MARKer:TABLE[:STATe] OFF ON 0 1	1052
:CALCulate:MARKer:TABLE[:STATe]?	1052
:CALCulate:MARKer:TRCKing[:STATe] OFF ON 0 1	1177
:CALCulate:MARKer:TRCKing[:STATe]?	1177
:CALCulate:MARKer[1] 2 3 4:	1040
:CALCulate:MARKer[1] 2 3 4 5 6 7 8 9 10 11 12:CPSeARch[:STATe] ON OFF 1 0	1156
:CALCulate:MARKer[1] 2 3 4 5 6 7 8 9 10 11 12:CPSeARch[:STATe]?	1156
:CALCulate:MARKer[1] 2 3 4 5 6 7 8 9 10 11 12:FCOunt:GATetime <time>	1056
:CALCulate:MARKer[1] 2 3 4 5 6 7 8 9 10 11 12:FCOunt:GATetime:AUTO OFF ON 0 1	1056
:CALCulate:MARKer[1] 2 3 4 5 6 7 8 9 10 11 12:FCOunt:GATetime:AUTO?	1056
:CALCulate:MARKer[1] 2 3 4 5 6 7 8 9 10 11 12:FCOunt:GATetime?	1056
:CALCulate:MARKer[1] 2 3 4 5 6 7 8 9 10 11 12:FCOunt:X?	1053

List of Commands

:CALCulate:MARKer[1] 2 3 4 5 6 7 8 9 10 11 12:FCOunt[:STATe] OFF ON 0 1	1052
:CALCulate:MARKer[1] 2 3 4 5 6 7 8 9 10 11 12:FCOunt[:STATe]?	1052
:CALCulate:MARKer[1] 2 3 4 5 6 7 8 9 10 11 12:FUNcTION NOISe BPOWer BDENsity OFF	1059
:CALCulate:MARKer[1] 2 3 4 5 6 7 8 9 10 11 12:FUNcTION:BANd:LEFT <freq>	1066
:CALCulate:MARKer[1] 2 3 4 5 6 7 8 9 10 11 12:FUNcTION:BANd:LEFT?	1066
:CALCulate:MARKer[1] 2 3 4 5 6 7 8 9 10 11 12:FUNcTION:BANd:RIGHt <freq>	1067
:CALCulate:MARKer[1] 2 3 4 5 6 7 8 9 10 11 12:FUNcTION:BANd:RIGHt?	1067
:CALCulate:MARKer[1] 2 3 4 5 6 7 8 9 10 11 12:FUNcTION:BANd:SPAN <freq>	1064
:CALCulate:MARKer[1] 2 3 4 5 6 7 8 9 10 11 12:FUNcTION:BANd:SPAN?	1064
:CALCulate:MARKer[1] 2 3 4 5 6 7 8 9 10 11 12:FUNcTION:MAMarker?	1068
:CALCulate:MARKer[1] 2 3 4 5 6 7 8 9 10 11 12:FUNcTION?	1059
:CALCulate:MARKer[1] 2 3 4 5 6 7 8 9 10 11 12:LINes[:STATe] OFF ON 0 1	1051
:CALCulate:MARKer[1] 2 3 4 5 6 7 8 9 10 11 12:LINes[:STATe]?	1051
:CALCulate:MARKer[1] 2 3 4 5 6 7 8 9 10 11 12:MAXimum	1145
:CALCulate:MARKer[1] 2 3 4 5 6 7 8 9 10 11 12:MAXimum:LEFT	1146
:CALCulate:MARKer[1] 2 3 4 5 6 7 8 9 10 11 12:MAXimum:NEXT	1146
:CALCulate:MARKer[1] 2 3 4 5 6 7 8 9 10 11 12:MAXimum:RIGHt	1146
:CALCulate:MARKer[1] 2 3 4 5 6 7 8 9 10 11 12:MINimum	1158
:CALCulate:MARKer[1] 2 3 4 5 6 7 8 9 10 11 12:MODE POSition DELTA FIXed OFF	1039
:CALCulate:MARKer[1] 2 3 4 5 6 7 8 9 10 11 12:MODE?	1039
:CALCulate:MARKer[1] 2 3 4 5 6 7 8 9 10 11 12:PTPeak	1158
:CALCulate:MARKer[1] 2 3 4 5 6 7 8 9 10 11 12:REFerence <integer>	1045
:CALCulate:MARKer[1] 2 3 4 5 6 7 8 9 10 11 12:REFerence?	1045
:CALCulate:MARKer[1] 2 3 4 5 6 7 8 9 10 11 12:TRACe 1 2 3 4 5 6	1049
:CALCulate:MARKer[1] 2 3 4 5 6 7 8 9 10 11 12:TRACe:AUTO OFF ON 0 1	1051
:CALCulate:MARKer[1] 2 3 4 5 6 7 8 9 10 11 12:TRACe:AUTO?	1051
:CALCulate:MARKer[1] 2 3 4 5 6 7 8 9 10 11 12:TRACe?	1049
:CALCulate:MARKer[1] 2 3 4 5 6 7 8 9 10 11 12:X <freq>	1040
:CALCulate:MARKer[1] 2 3 4 5 6 7 8 9 10 11 12:X:POSition <real>	1041
:CALCulate:MARKer[1] 2 3 4 5 6 7 8 9 10 11 12:X:POSition?	1041
:CALCulate:MARKer[1] 2 3 4 5 6 7 8 9 10 11 12:X:READout FREQuency TIME ITIME PERiod	1046

List of Commands

:CALCulate:MARKer[1] 2 3 4 5 6 7 8 9 10 11 12:X:READout:AUTO ON OFF 1 0	1046
:CALCulate:MARKer[1] 2 3 4 5 6 7 8 9 10 11 12:X:READout:AUTO?	1046
:CALCulate:MARKer[1] 2 3 4 5 6 7 8 9 10 11 12:X:READout?	1046
:CALCulate:MARKer[1] 2 3 4 5 6 7 8 9 10 11 12:X?	1040
:CALCulate:MARKer[1] 2 3 4 5 6 7 8 9 10 11 12:Y <real>	1042
:CALCulate:MARKer[1] 2 3 4 5 6 7 8 9 10 11 12:Y?	1042
:CALCulate:MARKer[1] 2 3 4 5 6 7 8 9 10 11 12[:SET]:CENTer	1079
:CALCulate:MARKer[1] 2 3 4 5 6 7 8 9 10 11 12[:SET]:DELTA:CENTer	1082
:CALCulate:MARKer[1] 2 3 4 5 6 7 8 9 10 11 12[:SET]:DELTA:SPAN	1081
:CALCulate:MARKer[1] 2 3 4 5 6 7 8 9 10 11 12[:SET]:RLEVel	1082
:CALCulate:MARKer[1] 2 3 4 5 6 7 8 9 10 11 12[:SET]:STARt	1080
:CALCulate:MARKer[1] 2 3 4 5 6 7 8 9 10 11 12[:SET]:STEP	1080
:CALCulate:MARKer[1] 2 3 4 5 6 7 8 9 10 11 12[:SET]:STOP	1081
:CALCulate:MATH TRACE1 TRACE2 TRACE3 TRACE4 TRACE5 TRACE6, PDifference PSUM LOFF- set LDifference OFF, TRACE1 TRACE2 TRACE3 TRACE4 TRACE5 TRACE6, TRACE1 TRACE2 TRACE3 TRACE4 TRACE5 TRACE6, <real>,<real>	1232
:CALCulate:MATH? TRACE1 TRACE2 TRACE3 TRACE4 TRACE5 TRACE6	1232
:CALCulate:MONitor:MARKer:AOFF	810
:CALCulate:MONitor:MARKer:COUple[:STATe] ON OFF 1 0	810
:CALCulate:MONitor:MARKer:COUple[:STATe]?	810
:CALCulate:MONitor:MARKer[1] 2 3 4 5 6 7 8 9 10 11 12 :FUNctIon NOISe BPOWer BDENsity OFF	811
:CALCulate:MONitor:MARKer[1] 2 3 4 5 6 7 8 9 10 11 12 :FUNctIon:Band:LEFt <freq>	812
:CALCulate:MONitor:MARKer[1] 2 3 4 5 6 7 8 9 10 11 12 :FUNctIon:Band:LEFt?	812
:CALCulate:MONitor:MARKer[1] 2 3 4 5 6 7 8 9 10 11 12 :FUNctIon:Band:RIGHt <freq>	813
:CALCulate:MONitor:MARKer[1] 2 3 4 5 6 7 8 9 10 11 12 :FUNctIon:Band:RIGHt?	813
:CALCulate:MONitor:MARKer[1] 2 3 4 5 6 7 8 9 10 11 12 :FUNctIon:Band:SPAN <freq>	812
:CALCulate:MONitor:MARKer[1] 2 3 4 5 6 7 8 9 10 11 12 :FUNctIon:Band:SPAN?	812
:CALCulate:MONitor:MARKer[1] 2 3 4 5 6 7 8 9 10 11 12 :FUNctIon?	811
:CALCulate:MONitor:MARKer[1] 2 3 4 5 6 7 8 9 10 11 12 :MODE POSition DELTA OFF	806
:CALCulate:MONitor:MARKer[1] 2 3 4 5 6 7 8 9 10 11 12 :MODE?	806
:CALCulate:MONitor:MARKer[1] 2 3 4 5 6 7 8 9 10 11 12 :REFerence <integer>	809
:CALCulate:MONitor:MARKer[1] 2 3 4 5 6 7 8 9 10 11 12 :REFerence?	809

List of Commands

:CALCulate:MONitor:MARKer[1] 2 3 4 5 6 7 8 9 10 11 12 :TRACe <integer>	809
:CALCulate:MONitor:MARKer[1] 2 3 4 5 6 7 8 9 10 11 12 :TRACe?	809
:CALCulate:MONitor:MARKer[1] 2 3 4 5 6 7 8 9 10 11 12 :X <freq>	807
:CALCulate:MONitor:MARKer[1] 2 3 4 5 6 7 8 9 10 11 12 :X:POSition <real>	807
:CALCulate:MONitor:MARKer[1] 2 3 4 5 6 7 8 9 10 11 12 :X:POSition?	807
:CALCulate:MONitor:MARKer[1] 2 3 4 5 6 7 8 9 10 11 12 :X?	807
:CALCulate:MONitor:MARKer[1] 2 3 4 5 6 7 8 9 10 11 12 :Y?	808
:CALCulate:NTData[:STATe] OFF ON 0 1	1239
:CALCulate:NTData[:STATe]?	1239
:CALCulate:OBWidth:LIMit:FBLimit <freq>	763
:CALCulate:OBWidth:LIMit:FBLimit?	763
:CALCulate:OBWidth:LIMit[:TEST] ON OFF 1 0	763
:CALCulate:OBWidth:LIMit[:TEST]?	763
:CALCulate:OBWidth:MARKer:AOFF	753
:CALCulate:OBWidth:MARKer[1] 2 3 4 5 6 7 8 9 10 11 12:MAXimum	768
:CALCulate:OBWidth:MARKer[1] 2 3 4 5 6 7 8 9 10 11 12:MODE POSition DELTA OFF	752
:CALCulate:OBWidth:MARKer[1] 2 3 4 5 6 7 8 9 10 11 12:MODE?	752
:CALCulate:OBWidth:MARKer[1] 2 3 4 5 6 7 8 9 10 11 12:REFerence <integer>.	753
:CALCulate:OBWidth:MARKer[1] 2 3 4 5 6 7 8 9 10 11 12:REFerence?	753
:CALCulate:OBWidth:MARKer[1] 2 3 4 5 6 7 8 9 10 11 12:STATe OFF ON 0 1	754
:CALCulate:OBWidth:MARKer[1] 2 3 4 5 6 7 8 9 10 11 12:STATe?	754
:CALCulate:OBWidth:MARKer[1] 2 3 4 5 6 7 8 9 10 11 12:X <real>.	750
:CALCulate:OBWidth:MARKer[1] 2 3 4 5 6 7 8 9 10 11 12:X:POSition <real>.	751
:CALCulate:OBWidth:MARKer[1] 2 3 4 5 6 7 8 9 10 11 12:X:POSition?.	751
:CALCulate:OBWidth:MARKer[1] 2 3 4 5 6 7 8 9 10 11 12:X?	750
:CALCulate:OBWidth:MARKer[1] 2 3 4 5 6 7 8 9 10 11 12:Y?	751
:CALCulate:PStatistic:MARKer:AOFF	495
:CALCulate:PStatistic:MARKer[1] 2 3 4 5 6 7 8 9 10 11 12:MODE POSition DELTA OFF	491
:CALCulate:PStatistic:MARKer[1] 2 3 4 5 6 7 8 9 10 11 12:MODE?.	491
:CALCulate:PStatistic:MARKer[1] 2 3 4 5 6 7 8 9 10 11 12:REFerence <integer>	494
:CALCulate:PStatistic:MARKer[1] 2 3 4 5 6 7 8 9 10 11 12:REFerence?.	494

List of Commands

:CALCulate:PStAtistic:MARKer[1] 2 3 4 5 6 7 8 9 10 11 12:TRACe MEASured GAUSSian REFerence	494
:CALCulate:PStAtistic:MARKer[1] 2 3 4 5 6 7 8 9 10 11 12:TRACe?	494
:CALCulate:PStAtistic:MARKer[1] 2 3 4 5 6 7 8 9 10 11 12:X <rel_amp>	492
:CALCulate:PStAtistic:MARKer[1] 2 3 4 5 6 7 8 9 10 11 12:X?	492
:CALCulate:PStAtistic:MARKer[1] 2 3 4 5 6 7 8 9 10 11 12:Y?	493
:CALCulate:PStAtistic:STORe:REFerence	515
:CALCulate:SEMAsk:LLINe:STATe ON OFF 1 0	629
:CALCulate:SEMAsk:LLINe:STATe?	629
:CALCulate:SEMAsk:MARKer:AOFF	547
:CALCulate:SEMAsk:MARKer:COUPle[:STATe] ON OFF 1 0	547
:CALCulate:SEMAsk:MARKer:COUPle[:STATe]?	547
:CALCulate:SEMAsk:MARKer[1] 2 3 4 5 6 7 8 9 10 11 12:MODE POSition OFF	544
:CALCulate:SEMAsk:MARKer[1] 2 3 4 5 6 7 8 9 10 11 12:MODE?	544
:CALCulate:SEMAsk:MARKer[1] 2 3 4 5 6 7 8 9 10 11 12:X <freq>	545
:CALCulate:SEMAsk:MARKer[1] 2 3 4 5 6 7 8 9 10 11 12:X:POSition <real>	546
:CALCulate:SEMAsk:MARKer[1] 2 3 4 5 6 7 8 9 10 11 12:X:POSition?	546
:CALCulate:SEMAsk:MARKer[1] 2 3 4 5 6 7 8 9 10 11 12:X?.	545
:CALCulate:SEMAsk:MARKer[1] 2 3 4 5 6 7 8 9 10 11 12:Y?.	546
:CALCulate:WAVeform:MARKer:AOFF	871
:CALCulate:WAVeform:MARKer:COUPle[:STATe] ON OFF 1 0	870
:CALCulate:WAVeform:MARKer:COUPle[:STATe]?	870
:CALCulate:WAVeform:MARKer[1] 2 3 4 5 6 7 8 9 10 11 12:FUNCTion BPOWer BDENSity OFF	872
:CALCulate:WAVeform:MARKer[1] 2 3 4 5 6 7 8 9 10 11 12:FUNCTion:BAND:LEFT <time>	874
:CALCulate:WAVeform:MARKer[1] 2 3 4 5 6 7 8 9 10 11 12:FUNCTion:BAND:LEFT?	874
:CALCulate:WAVeform:MARKer[1] 2 3 4 5 6 7 8 9 10 11 12:FUNCTion:BAND:RIGHT <time>	875
:CALCulate:WAVeform:MARKer[1] 2 3 4 5 6 7 8 9 10 11 12:FUNCTion:BAND:RIGHT?	875
:CALCulate:WAVeform:MARKer[1] 2 3 4 5 6 7 8 9 10 11 12:FUNCTion:BAND:SPAN <time>	873
:CALCulate:WAVeform:MARKer[1] 2 3 4 5 6 7 8 9 10 11 12:FUNCTion:BAND:SPAN?	873
:CALCulate:WAVeform:MARKer[1] 2 3 4 5 6 7 8 9 10 11 12:FUNCTion?	872
:CALCulate:WAVeform:MARKer[1] 2 3 4 5 6 7 8 9 10 11 12:MAXimum	889
:CALCulate:WAVeform:MARKer[1] 2 3 4 5 6 7 8 9 10 11 12:MAXimum:NEXT	889

List of Commands

:CALCulate:WAVEform:MARKer[1] 2 3 4 5 6 7 8 9 10 11 12:MINimum	890
:CALCulate:WAVEform:MARKer[1] 2 3 4 5 6 7 8 9 10 11 12:MODE POSition DELTA OFF	865
:CALCulate:WAVEform:MARKer[1] 2 3 4 5 6 7 8 9 10 11 12:MODE?	865
:CALCulate:WAVEform:MARKer[1] 2 3 4 5 6 7 8 9 10 11 12:REFerence <integer>	869
:CALCulate:WAVEform:MARKer[1] 2 3 4 5 6 7 8 9 10 11 12:REFerence?	869
:CALCulate:WAVEform:MARKer[1] 2 3 4 5 6 7 8 9 10 11 12:STATe OFF ON 0 1	871
:CALCulate:WAVEform:MARKer[1] 2 3 4 5 6 7 8 9 10 11 12:STATe?	871
:CALCulate:WAVEform:MARKer[1] 2 3 4 5 6 7 8 9 10 11 12:TRACe RFENvelope IQ	869
:CALCulate:WAVEform:MARKer[1] 2 3 4 5 6 7 8 9 10 11 12:TRACe?	869
:CALCulate:WAVEform:MARKer[1] 2 3 4 5 6 7 8 9 10 11 12:X <time>	866
:CALCulate:WAVEform:MARKer[1] 2 3 4 5 6 7 8 9 10 11 12:X:POSition <real>	867
:CALCulate:WAVEform:MARKer[1] 2 3 4 5 6 7 8 9 10 11 12:X:POSition?	867
:CALCulate:WAVEform:MARKer[1] 2 3 4 5 6 7 8 9 10 11 12:X?	866
:CALCulate:WAVEform:MARKer[1] 2 3 4 5 6 7 8 9 10 11 12:Y?	868
:CALibration:AUTO ON PARTial OFF	208
:CALibration:AUTO:ALERT TTEMPerature DAY WEEK NONE	211
:CALibration:AUTO:ALERT?	211
:CALibration:AUTO:MODE ALL NRF	211
:CALibration:AUTO:MODE?	211
:CALibration:AUTO:TIME:OFF?	221
:CALibration:AUTO?	208
:CALibration:DATA:BACKup <filename>	229
:CALibration:DATA:DEFault	223
:CALibration:DATA:RESTore <filename>	229
:CALibration:FREQuency:REFerence:COARse <integer>	232
:CALibration:FREQuency:REFerence:COARse?	232
:CALibration:FREQuency:REFerence:FINE <integer>	232
:CALibration:FREQuency:REFerence:FINE?	232
:CALibration:FREQuency:REFerence:MODE CALibrated USER	231
:CALibration:FREQuency:REFerence:MODE?	231
:CALibration:IQ:FLATness:I	989

List of Commands

:CALibration:IQ:FLATness:I IBAR Q QBAR:TIME?	993
:CALibration:IQ:FLATness:IBAR	990
:CALibration:IQ:FLATness:Q	991
:CALibration:IQ:FLATness:QBAR	992
:CALibration:IQ:ISOLation	987
:CALibration:IQ:ISOLation:TIME?	988
:CALibration:IQ:PROBe:I	994
:CALibration:IQ:PROBe:I IBAR Q QBAR:TIME?	998
:CALibration:IQ:PROBe:I Q:CLear	986
:CALibration:IQ:PROBe:IBar	995
:CALibration:IQ:PROBe:Q	997
:CALibration:IQ:PROBe:QBar	998
:CALibration:NRF?	216
:CALibration:NRF	216
:CALibration:RF?	218
:CALibration:RF	218
:CALibration:TEMPerature:CURRent?	219
:CALibration:TEMPerature:LALL?	220
:CALibration:TEMPerature:LPReselector?	221
:CALibration:TEMPerature:LRF?	221
:CALibration:TIME:LALL?	220
:CALibration:TIME:LPReselector?	221
:CALibration:TIME:LRF?	220
:CALibration:YTF?	230
:CALibration:YTF	230
:CALibration[:ALL]?	215
:CALibration[:ALL]	215
:CONFigure:ACP:NDEFault	367
:CONFigure:ACPower	443
:CONFigure:ACP	367
:CONFigure:CHPower	332

List of Commands

:CONFigure:CHPower:NDEFault	295
:CONFigure:CHPower	295
:CONFigure:EVM	677
:CONFigure:MONitor	817
:CONFigure:MONitor:NDEFault	791
:CONFigure:MONitor	791
:CONFigure:OBWidth	764
:CONFigure:OBWidth:NDEFault	735
:CONFigure:OBWidth	735
:CONFigure:PSTatistic	504
:CONFigure:PSTatistic:NDEFault	479
:CONFigure:PSTatistic	479
:CONFigure:SEMAsk	585
:CONFigure:SEMAsk:NDEFault	523
:CONFigure:SEMAsk	523
:CONFigure:WAVeform	882
:CONFigure:WAVeform:NDEFault	839
:CONFigure:WAVeform	839
:CONFigure?	1086
:COUple ALL NONE	943
:DISPlay:<measurement>:ANNotation:TITLe:DATA <string>	1317
:DISPlay:<measurement>:ANNotation:TITLe:DATA?	1317
:DISPlay:ACPower:VIEW[1]:WINDow[1]:BGRaph OFF ON 0 1	476
:DISPlay:ACPower:VIEW[1]:WINDow[1]:BGRaph?	476
:DISPlay:ACPower:VIEW[1]:WINDow[1]:TRACe:Y[:SCALe]:COUple 0 1 OFF ON	382
:DISPlay:ACPower:VIEW[1]:WINDow[1]:TRACe:Y[:SCALe]:COUple?	382
:DISPlay:ACPower:VIEW[1]:WINDow[1]:TRACe:Y[:SCALe]:PDIVision <rel_amp>	379
:DISPlay:ACPower:VIEW[1]:WINDow[1]:TRACe:Y[:SCALe]:PDIVision?	379
:DISPlay:ACPower:VIEW[1]:WINDow[1]:TRACe:Y[:SCALe]:RLEVel <real>	378
:DISPlay:ACPower:VIEW[1]:WINDow[1]:TRACe:Y[:SCALe]:RLEVel?	378
:DISPlay:ACPower:VIEW[1]:WINDow[1]:TRACe:Y[:SCALe]:RPOStion TOP CENTer BOTTom	381

List of Commands

:DISPlay:ACPower:VIEW[1]:WINDow[1]:TRACe:Y[:SCALe]:RPOSition?	381
:DISPlay:ACTivefunc[:STATe] ON OFF 1 0	1316
:DISPlay:ACTivefunc[:STATe]?	1316
:DISPlay:ANNotation:MBAR[:STATe] OFF ON 0 1	1314
:DISPlay:ANNotation:MBAR[:STATe]?	1314
:DISPlay:ANNotation:SCReen[:STATe] OFF ON 0 1	1315
:DISPlay:ANNotation:SCReen[:STATe]?	1315
:DISPlay:ANNotation:TRACe[:STATe] ON OFF 1 0	1315
:DISPlay:ANNotation:TRACe[:STATe]?	1315
:DISPlay:BACKlight ON OFF	1320
:DISPlay:BACKlight:INTensity <integer>	1321
:DISPlay:BACKlight:INTensity?	1321
:DISPlay:BACKlight?	1320
:DISPlay:CHPower:VIEW:MASK[:SElect] LSNI GPNI IPNI GPA2 KSKP	364
:DISPlay:CHPower:VIEW:MASK[:SElect]?	364
:DISPlay:CHPower:VIEW[:SElect] RFSPectrum SHOUlder MASK	355
:DISPlay:CHPower:VIEW[:SElect] RFSPectrum SHOUlder	356
:DISPlay:CHPower:VIEW[:SElect]?	355
:DISPlay:CHPower:VIEW[:SElect]?	356
:DISPlay:CHPower:VIEW[1]:WINDow[1]:BGRaph ON OFF 1 0	357
:DISPlay:CHPower:VIEW[1]:WINDow[1]:BGRaph?	357
:DISPlay:CHPower:VIEW[1]:WINDow[1]:TRACe:Y[:SCALe]:COUple 0 1 OFF ON	304
:DISPlay:CHPower:VIEW[1]:WINDow[1]:TRACe:Y[:SCALe]:COUple?	304
:DISPlay:CHPower:VIEW[1]:WINDow[1]:TRACe:Y[:SCALe]:PDIVision <rel_amp>	301
:DISPlay:CHPower:VIEW[1]:WINDow[1]:TRACe:Y[:SCALe]:PDIVision?	301
:DISPlay:CHPower:VIEW[1]:WINDow[1]:TRACe:Y[:SCALe]:RLEVel <real>	300
:DISPlay:CHPower:VIEW[1]:WINDow[1]:TRACe:Y[:SCALe]:RLEVel?	300
:DISPlay:CHPower:VIEW[1]:WINDow[1]:TRACe:Y[:SCALe]:RPOSition TOP CENTer BOTTom	303
:DISPlay:CHPower:VIEW[1]:WINDow[1]:TRACe:Y[:SCALe]:RPOSition?	303
:DISPlay:ENABle OFF ON 0 1	1322
:DISPlay:ENABle?	1322

List of Commands

:DISPlay:EVM:CARRier:STARt <integer>	717
:DISPlay:EVM:CARRier:STARt?	717
:DISPlay:EVM:CARRier:STOP <integer>	717
:DISPlay:EVM:CARRier:STOP?	717
:DISPlay:EVM:CPRBar[:STATe] OFF ON 0 1	727
:DISPlay:EVM:CPRBar[:STATe]?	727
:DISPlay:EVM:TS:INDex <integer>	718
:DISPlay:EVM:TS:INDex?	718
:DISPlay:EVM:VIEW:NSElect <integer>	733
:DISPlay:EVM:VIEW:NSElect?	733
:DISPlay:EVM:VIEW[:SElect] POLar IQERror FREQuency IMPulse FLATness MERTimeslot NRESults ...	714
:DISPlay:EVM:VIEW[:SElect]?	714
:DISPlay:EVM:VIEW2:WINDow[1]:TRACe:X[:SCALe]:COUPle OFF ON 0 1	706
:DISPlay:EVM:VIEW2:WINDow[1]:TRACe:X[:SCALe]:COUPle?	706
:DISPlay:EVM:VIEW2:WINDow[1]:TRACe:X[:SCALe]:FREQuency:PDIVision <real>	699
:DISPlay:EVM:VIEW2:WINDow[1]:TRACe:X[:SCALe]:FREQuency:PDIVision?	699
:DISPlay:EVM:VIEW2:WINDow[1]:TRACe:X[:SCALe]:FREQuency:RLEVel <real>	695
:DISPlay:EVM:VIEW2:WINDow[1]:TRACe:X[:SCALe]:FREQuency:RLEVel?	695
:DISPlay:EVM:VIEW2:WINDow[1]:TRACe:X[:SCALe]:RPOStion LEFT CENTer RIGHT	703
:DISPlay:EVM:VIEW2:WINDow[1]:TRACe:X[:SCALe]:RPOStion?	703
:DISPlay:EVM:VIEW2:WINDow[1]:TRACe:X[:SCALe]:TYPE CARRier FREQuency	709
:DISPlay:EVM:VIEW2:WINDow[1]:TRACe:X[:SCALe]:TYPE?	709
:DISPlay:EVM:VIEW2:WINDow[1]:TRACe:X[:SCALe][:CARRier]:PDIVision <real>	699
:DISPlay:EVM:VIEW2:WINDow[1]:TRACe:X[:SCALe][:CARRier]:PDIVision?	699
:DISPlay:EVM:VIEW2:WINDow[1]:TRACe:X[:SCALe][:CARRier]:RLEVel <real>	694
:DISPlay:EVM:VIEW2:WINDow[1]:TRACe:X[:SCALe][:CARRier]:RLEVel?	694
:DISPlay:EVM:VIEW2:WINDow[1]:TRACe:Y[:SCALe]:COUPle OFF ON 0 1	649
:DISPlay:EVM:VIEW2:WINDow[1]:TRACe:Y[:SCALe]:COUPle?	649
:DISPlay:EVM:VIEW2:WINDow[1]:TRACe:Y[:SCALe]:EVM:PDIVision <real>	642
:DISPlay:EVM:VIEW2:WINDow[1]:TRACe:Y[:SCALe]:EVM:PDIVision?	642
:DISPlay:EVM:VIEW2:WINDow[1]:TRACe:Y[:SCALe]:EVM:RLEVel <real>	637

List of Commands

:DISPlay:EVM:VIEW2:WINDow[1]:TRACe:Y[:SCALe]:EVM:RLEVel?	637
:DISPlay:EVM:VIEW2:WINDow[1]:TRACe:Y[:SCALe]:RPOSition TOP CENTer BOTTom	646
:DISPlay:EVM:VIEW2:WINDow[1]:TRACe:Y[:SCALe]:RPOSition?	646
:DISPlay:EVM:VIEW2:WINDow[1]:TRACe:Y[:SCALe]:TYPE MER EVM	645
:DISPlay:EVM:VIEW2:WINDow[1]:TRACe:Y[:SCALe]:TYPE?	645
:DISPlay:EVM:VIEW2:WINDow[1]:TRACe:Y[:SCALe][:MER]:PDIVision <real>	641
:DISPlay:EVM:VIEW2:WINDow[1]:TRACe:Y[:SCALe][:MER]:PDIVision?	641
:DISPlay:EVM:VIEW2:WINDow[1]:TRACe:Y[:SCALe][:MER]:RLEVel <real>	636
:DISPlay:EVM:VIEW2:WINDow[1]:TRACe:Y[:SCALe][:MER]:RLEVel?	636
:DISPlay:EVM:VIEW3:WINDow2:TRACe:X[:SCALe]:COUPlE OFF ON 0 1	707
:DISPlay:EVM:VIEW3:WINDow2:TRACe:X[:SCALe]:COUPlE?	707
:DISPlay:EVM:VIEW3:WINDow2:TRACe:X[:SCALe]:PDIVision <real>	701
:DISPlay:EVM:VIEW3:WINDow2:TRACe:X[:SCALe]:PDIVision?	701
:DISPlay:EVM:VIEW3:WINDow2:TRACe:X[:SCALe]:RLEVel <real>	696
:DISPlay:EVM:VIEW3:WINDow2:TRACe:X[:SCALe]:RLEVel?	696
:DISPlay:EVM:VIEW3:WINDow2:TRACe:X[:SCALe]:RPOSition LEFT CENTer RIGHt	704
:DISPlay:EVM:VIEW3:WINDow2:TRACe:X[:SCALe]:RPOSition?	704
:DISPlay:EVM:VIEW3:WINDow2:TRACe:Y[:SCALe]:COUPlE OFF ON 0 1	650
:DISPlay:EVM:VIEW3:WINDow2:TRACe:Y[:SCALe]:COUPlE?	650
:DISPlay:EVM:VIEW3:WINDow2:TRACe:Y[:SCALe]:PDIVision <real>	643
:DISPlay:EVM:VIEW3:WINDow2:TRACe:Y[:SCALe]:PDIVision?	643
:DISPlay:EVM:VIEW3:WINDow2:TRACe:Y[:SCALe]:RLEVel <real>	638
:DISPlay:EVM:VIEW3:WINDow2:TRACe:Y[:SCALe]:RLEVel?	638
:DISPlay:EVM:VIEW3:WINDow2:TRACe:Y[:SCALe]:RPOSition TOP CENTer BOTTom	647
:DISPlay:EVM:VIEW3:WINDow2:TRACe:Y[:SCALe]:RPOSition?	647
:DISPlay:EVM:VIEW3:WINDow3:TRACe:X[:SCALe]:COUPlE OFF ON 0 1	708
:DISPlay:EVM:VIEW3:WINDow3:TRACe:X[:SCALe]:COUPlE?	708
:DISPlay:EVM:VIEW3:WINDow3:TRACe:X[:SCALe]:PDIVision <real>	701
:DISPlay:EVM:VIEW3:WINDow3:TRACe:X[:SCALe]:PDIVision?	701
:DISPlay:EVM:VIEW3:WINDow3:TRACe:X[:SCALe]:RLEVel <real>	697
:DISPlay:EVM:VIEW3:WINDow3:TRACe:X[:SCALe]:RLEVel?	697

List of Commands

:DISPlay:EVM:VIEW3:WINDow3:TRACe:X[:SCALe]:RPOSition LEFT CENTer RIGHT	705
:DISPlay:EVM:VIEW3:WINDow3:TRACe:X[:SCALe]:RPOSition?	705
:DISPlay:EVM:VIEW3:WINDow3:TRACe:Y[:SCALe]:COUPlE OFF ON 0 1	651
:DISPlay:EVM:VIEW3:WINDow3:TRACe:Y[:SCALe]:COUPlE?	651
:DISPlay:EVM:VIEW3:WINDow3:TRACe:Y[:SCALe]:PDIVision <real>	644
:DISPlay:EVM:VIEW3:WINDow3:TRACe:Y[:SCALe]:PDIVision?	644
:DISPlay:EVM:VIEW3:WINDow3:TRACe:Y[:SCALe]:RLEVel <real>	639
:DISPlay:EVM:VIEW3:WINDow3:TRACe:Y[:SCALe]:RLEVel?	639
:DISPlay:EVM:VIEW3:WINDow3:TRACe:Y[:SCALe]:RPOSition TOP CENTer BOTTom	648
:DISPlay:EVM:VIEW3:WINDow3:TRACe:Y[:SCALe]:RPOSition?	648
:DISPlay:EVM:VIEW3 5:WINDow[1]:TRACe:X[:SCALe]:COUPlE OFF ON 0 1	706
:DISPlay:EVM:VIEW3 5:WINDow[1]:TRACe:X[:SCALe]:COUPlE?	706
:DISPlay:EVM:VIEW3 5:WINDow[1]:TRACe:X[:SCALe]:PDIVision <real>	700
:DISPlay:EVM:VIEW3 5:WINDow[1]:TRACe:X[:SCALe]:PDIVision?	700
:DISPlay:EVM:VIEW3 5:WINDow[1]:TRACe:X[:SCALe]:RLEVel <real>	696
:DISPlay:EVM:VIEW3 5:WINDow[1]:TRACe:X[:SCALe]:RLEVel?	696
:DISPlay:EVM:VIEW3 5:WINDow[1]:TRACe:X[:SCALe]:RPOSition LEFT CENTer RIGHT	703
:DISPlay:EVM:VIEW3 5:WINDow[1]:TRACe:X[:SCALe]:RPOSition?	703
:DISPlay:EVM:VIEW3 5:WINDow[1]:TRACe:Y[:SCALe]:COUPlE OFF ON 0 1	650
:DISPlay:EVM:VIEW3 5:WINDow[1]:TRACe:Y[:SCALe]:COUPlE?	650
:DISPlay:EVM:VIEW3 5:WINDow[1]:TRACe:Y[:SCALe]:PDIVision <real>	642
:DISPlay:EVM:VIEW3 5:WINDow[1]:TRACe:Y[:SCALe]:PDIVision?	642
:DISPlay:EVM:VIEW3 5:WINDow[1]:TRACe:Y[:SCALe]:RLEVel <real>	638
:DISPlay:EVM:VIEW3 5:WINDow[1]:TRACe:Y[:SCALe]:RLEVel?	638
:DISPlay:EVM:VIEW3 5:WINDow[1]:TRACe:Y[:SCALe]:RPOSition TOP CENTer BOTTom	647
:DISPlay:EVM:VIEW3 5:WINDow[1]:TRACe:Y[:SCALe]:RPOSition?	647
:DISPlay:EVM:VIEW4:WINDow[1]:TRACe:X[:SCALe]:COUPlE OFF ON 0 1	708
:DISPlay:EVM:VIEW4:WINDow[1]:TRACe:X[:SCALe]:COUPlE?	708
:DISPlay:EVM:VIEW4:WINDow[1]:TRACe:X[:SCALe]:PDIVision <real>	702
:DISPlay:EVM:VIEW4:WINDow[1]:TRACe:X[:SCALe]:PDIVision?	702
:DISPlay:EVM:VIEW4:WINDow[1]:TRACe:X[:SCALe]:RLEVel <real>	698

List of Commands

:DISPlay:EVM:VIEW4:WINDow[1]:TRACe:X[:SCALe]:RLEVel?	698
:DISPlay:EVM:VIEW4:WINDow[1]:TRACe:X[:SCALe]:RPOSition LEFT CENTer RIGHt	705
:DISPlay:EVM:VIEW4:WINDow[1]:TRACe:X[:SCALe]:RPOSition?	705
:DISPlay:EVM:VIEW4:WINDow[1]:TRACe:Y[:SCALe]:COUPlE OFF ON 0 1	652
:DISPlay:EVM:VIEW4:WINDow[1]:TRACe:Y[:SCALe]:COUPlE?	652
:DISPlay:EVM:VIEW4:WINDow[1]:TRACe:Y[:SCALe]:PDIVision <real>	644
:DISPlay:EVM:VIEW4:WINDow[1]:TRACe:Y[:SCALe]:PDIVision?	644
:DISPlay:EVM:VIEW4:WINDow[1]:TRACe:Y[:SCALe]:RLEVel <real>	640
:DISPlay:EVM:VIEW4:WINDow[1]:TRACe:Y[:SCALe]:RLEVel?	640
:DISPlay:EVM:VIEW4:WINDow[1]:TRACe:Y[:SCALe]:RPOSition TOP CENTer BOTTom	648
:DISPlay:EVM:VIEW4:WINDow[1]:TRACe:Y[:SCALe]:RPOSition?	648
:DISPlay:FSCReen[:STATe] OFF ON 0 1	1321
:DISPlay:FSCReen[:STATe]?	1321
:DISPlay:MONitor:VIEW:WINDow:TRACe[1] 2 3:CLear	835
:DISPlay:MONitor:VIEW[1]:WINDow[1]:TRACe:Y[:SCALe] :COUPlE 0 1 OFF ON	794
:DISPlay:MONitor:VIEW[1]:WINDow[1]:TRACe:Y[:SCALe] :COUPlE?	794
:DISPlay:MONitor:VIEW[1]:WINDow[1]:TRACe:Y[:SCALe] :PDIVision <rel_ampl>	793
:DISPlay:MONitor:VIEW[1]:WINDow[1]:TRACe:Y[:SCALe] :PDIVision?	793
:DISPlay:MONitor:VIEW[1]:WINDow[1]:TRACe:Y[:SCALe] :RLEVel <real>	792
:DISPlay:MONitor:VIEW[1]:WINDow[1]:TRACe:Y[:SCALe] :RLEVel?	792
:DISPlay:MONitor:VIEW[1]:WINDow[1]:TRACe:Y[:SCALe] :RPOSition TOP CENTer BOTTom	794
:DISPlay:MONitor:VIEW[1]:WINDow[1]:TRACe:Y[:SCALe] :RPOSition?	794
:DISPlay:OBWidth:VIEW[1]:WINDow[1]:TRACe:Y[:SCALe]:COUPlE 0 1 OFF ON	741
:DISPlay:OBWidth:VIEW[1]:WINDow[1]:TRACe:Y[:SCALe]:COUPlE?	741
:DISPlay:OBWidth:VIEW[1]:WINDow[1]:TRACe:Y[:SCALe]:PDIVision <rel_ampl>	738
:DISPlay:OBWidth:VIEW[1]:WINDow[1]:TRACe:Y[:SCALe]:PDIVision?	738
:DISPlay:OBWidth:VIEW[1]:WINDow[1]:TRACe:Y[:SCALe]:RLEVel <real>	737
:DISPlay:OBWidth:VIEW[1]:WINDow[1]:TRACe:Y[:SCALe]:RLEVel?	737
:DISPlay:OBWidth:VIEW[1]:WINDow[1]:TRACe:Y[:SCALe]:RPOSition TOP CENTer BOTTom	740
:DISPlay:OBWidth:VIEW[1]:WINDow[1]:TRACe:Y[:SCALe]:RPOSition?	740
:DISPlay:PSTATistic:GAUSSian[:STATe] OFF ON 0 1	516

List of Commands

:DISPlay:PSStatistic:GAUSSian[:STATe]?	516
:DISPlay:PSStatistic:RTRace[:STATe] OFF ON 0 1	515
:DISPlay:PSStatistic:RTRace[:STATe]?	515
:DISPlay:PSStatistic:VIEW[1]:WINDow2:TRACe:X[:SCALe]:PDIVision <rel_ampl>	513
:DISPlay:PSStatistic:VIEW[1]:WINDow2:TRACe:X[:SCALe]:PDIVision?	513
:DISPlay:SEMask:VIEW:NSElect <integer>	613
:DISPlay:SEMask:VIEW:NSElect?	613
:DISPlay:SEMask:VIEW[:SElect] APFReq RPFReq IPOWER	613
:DISPlay:SEMask:VIEW[:SElect]?	613
:DISPlay:SEMask:VIEW[1]:WINDow[1]:TRACe:Y[:SCALe]:COUple 0 1 ON OFF	537
:DISPlay:SEMask:VIEW[1]:WINDow[1]:TRACe:Y[:SCALe]:COUple?	537
:DISPlay:SEMask:VIEW[1]:WINDow[1]:TRACe:Y[:SCALe]:PDIVision <rel_ampl>	535
:DISPlay:SEMask:VIEW[1]:WINDow[1]:TRACe:Y[:SCALe]:PDIVision?	535
:DISPlay:SEMask:VIEW[1]:WINDow[1]:TRACe:Y[:SCALe]:RLEVel <real>	534
:DISPlay:SEMask:VIEW[1]:WINDow[1]:TRACe:Y[:SCALe]:RLEVel?	534
:DISPlay:SEMask:VIEW[1]:WINDow[1]:TRACe:Y[:SCALe]:RPOSition TOP CENTer BOTTom	537
:DISPlay:SEMask:VIEW[1]:WINDow[1]:TRACe:Y[:SCALe]:RPOSition?	537
:DISPlay:THEMe TDColor TDMonochrome FCOLor FMONochrome	1320
:DISPlay:THEMe?	1320
:DISPlay:WAVEform:VIEW:NSElect <integer>	902
:DISPlay:WAVEform:VIEW:NSElect?	902
:DISPlay:WAVEform:VIEW[:SElect] RFENvelope IQ	902
:DISPlay:WAVEform:VIEW[:SElect]?	902
:DISPlay:WAVEform:VIEW[1]:WINDow[1]:TRACe:Y[:SCALe]:PDIVision <rel_ampl>	843
:DISPlay:WAVEform:VIEW[1]:WINDow[1]:TRACe:Y[:SCALe]:PDIVision?	843
:DISPlay:WAVEform:VIEW[1]:WINDow[1]:TRACe:Y[:SCALe]:RLEVel <ampl>	841
:DISPlay:WAVEform:VIEW[1]:WINDow[1]:TRACe:Y[:SCALe]:RLEVel?	841
:DISPlay:WAVEform:VIEW[1]:WINDow[1]:TRACe:Y[:SCALe]:RPOSition TOP CENTer BOTTom	846
:DISPlay:WAVEform:VIEW[1]:WINDow[1]:TRACe:Y[:SCALe]:RPOSition?	846
:DISPlay:WAVEform:VIEW[1]2:WINDow[1]:TRACe:X[:SCALe]:COUple 0 1 OFF ON	898
:DISPlay:WAVEform:VIEW[1]2:WINDow[1]:TRACe:X[:SCALe]:COUple?	898

List of Commands

:DISPlay:WAVeform:VIEW[1]2:WINDow[1]:TRACe:X[:SCALe]:PDIVision <time>	897
:DISPlay:WAVeform:VIEW[1]2:WINDow[1]:TRACe:X[:SCALe]:PDIVision?	897
:DISPlay:WAVeform:VIEW[1]2:WINDow[1]:TRACe:X[:SCALe]:RLEVel <time>	896
:DISPlay:WAVeform:VIEW[1]2:WINDow[1]:TRACe:X[:SCALe]:RLEVel?	896
:DISPlay:WAVeform:VIEW[1]2:WINDow[1]:TRACe:X[:SCALe]:RPOSition LEFT CENTer RIGHT	897
:DISPlay:WAVeform:VIEW[1]2:WINDow[1]:TRACe:X[:SCALe]:RPOSition?	897
:DISPlay:WAVeform:VIEW[1]2:WINDow[1]:TRACe:Y[:SCALe]:COUPlE 0 1 OFF ON	847
:DISPlay:WAVeform:VIEW[1]2:WINDow[1]:TRACe:Y[:SCALe]:COUPlE?	847
:DISPlay:WAVeform:VIEW2:WINDow[1]:TRACe:Y[:SCALe]:PDIVision <voltage>	844
:DISPlay:WAVeform:VIEW2:WINDow[1]:TRACe:Y[:SCALe]:PDIVision?	844
:DISPlay:WAVeform:VIEW2:WINDow[1]:TRACe:Y[:SCALe]:RLEVel <voltage>	842
:DISPlay:WAVeform:VIEW2:WINDow[1]:TRACe:Y[:SCALe]:RLEVel?	842
:DISPlay:WAVeform:VIEW2:WINDow[1]:TRACe:Y[:SCALe]:RPOSition TOP CENTer BOTTom	846
:DISPlay:WAVeform:VIEW2:WINDow[1]:TRACe:Y[:SCALe]:RPOSition?	846
:DISPlay:WINDow:FORMat:TILE	124
:DISPlay:WINDow:FORMat:ZOOM	124
:DISPlay:WINDow:MAMarker:POSition LEFT RIGHT	1072
:DISPlay:WINDow:MAMarker:POSition?	1072
:DISPlay:WINDow:MAMarker[:STATe] ON OFF 1 0	1072
:DISPlay:WINDow:MAMarker[:STATe]?	1072
:DISPlay:WINDow[:SELEct] <number>	125
:DISPlay:WINDow[:SELEct]?	125
:DISPlay:WINDow[1]:ANNotation[:ALL] OFF ON 0 1	1319
:DISPlay:WINDow[1]:ANNotation[:ALL]?	1319
:DISPlay:WINDow[1]:TRACe:GRATicule:GRID[:STATe] OFF ON 0 1	1318
:DISPlay:WINDow[1]:TRACe:GRATicule:GRID[:STATe]?	1318
:DISPlay:WINDow[1]:TRACe:Y:DLINe <ampl>	1319
:DISPlay:WINDow[1]:TRACe:Y:DLINe:STATe OFF ON 0 1	1319
:DISPlay:WINDow[1]:TRACe:Y:DLINe:STATe?	1319
:DISPlay:WINDow[1]:TRACe:Y:DLINe?	1319
:DISPlay:WINDow[1]:TRACe:Y[:SCALe]:NRLevel <rel_ampl>	1242

List of Commands

:DISPlay:WINDow[1]:TRACe:Y[:SCALe]:NRLevel?	1242
:DISPlay:WINDow[1]:TRACe:Y[:SCALe]:NRPosition <integer>	1243
:DISPlay:WINDow[1]:TRACe:Y[:SCALe]:NRPosition?	1243
:DISPlay:WINDow[1]:TRACe:Y[:SCALe]:PDIVision <rel_ampl>	925
:DISPlay:WINDow[1]:TRACe:Y[:SCALe]:PDIVision?	925
:DISPlay:WINDow[1]:TRACe:Y[:SCALe]:RLEVel <real>	909
:DISPlay:WINDow[1]:TRACe:Y[:SCALe]:RLEVel:OFFSet <rel_ampl>	934
:DISPlay:WINDow[1]:TRACe:Y[:SCALe]:RLEVel:OFFSet?	934
:DISPlay:WINDow[1]:TRACe:Y[:SCALe]:RLEVel?	909
:DISPlay:WINDow[1]:TRACe:Y[:SCALe]:SPACing LINear LOGarithmic	925
:DISPlay:WINDow[1]:TRACe:Y[:SCALe]:SPACing?	925
:FETCh:ACP[n]?	367
:FETCh:CHPower:CHPower?	295
:FETCh:CHPower:DENSity?	295
:FETCh:CHPower[n]?	295
:FETCh:MONitor[n]?	791
:FETCh:OBWidth [n]?	735
:FETCh:OBWidth:FERRor?	735
:FETCh:OBWidth:OBWidth?	735
:FETCh:OBWidth:XDB?	735
:FETCh:PSTatistic[n]?	479
:FETCh:SEMAsk[n]?	523
:FETCh:WAVEform[n]	839
:FORMat:BORDER NORMAl SWAPped	1096
:FORMat:BORDER?	1096
:FORMat[:TRACe][:DATA] ASCii INTeger,32 REAL,32 REAL,64.	1094
:FORMat[:TRACe][:DATA]?	1094
:HCOPy:ABORT.	150
:HCOPy[:IMMediate]	150
:INITiate:ACP	367
:INITiate:CHPower	295

List of Commands

:INITiate:CONTinuous OFF ON 0 1	957
:INITiate:CONTinuous?	957
:INITiate:MONitor	791
:INITiate:OBWidth	735
:INITiate:PAUSE	1193
:INITiate:PSTatistic	479
:INITiate:REStart	1163
:INITiate:RESume	1193
:INITiate:SEMAsk	523
:INITiate:WAVeform	839
:INITiate[:IMMediate]	1163
:INPut:COUPling AC DC	971
:INPut:COUPling:I Q DC LFR1 LFR2	984
:INPut:COUPling:I Q?	984
:INPut:COUPling?	971
:INPut:IMPedance:IQ U50 B50 U1M B1M	979
:INPut:IMPedance:IQ?	979
:INPut:IMPedance:REFeRence <integer>	986
:INPut:IMPedance:REFeRence?	986
:INPut:IQ:MIRRored OFF ON 0 1	980
:INPut:IQ:MIRRored?	980
:INPut:IQ:Q:DIFFerential OFF ON 0 1	980
:INPut:IQ:Q:DIFFerential?	980
:INPut:IQ[:I]:DIFFerential OFF ON 0 1	976
:INPut:IQ[:I]:DIFFerential?	976
:INPut:OFFSet:I Q <voltage>	984
:INPut:OFFSet:I Q?	984
:INPut[1]:IQ:BALanced[:STATe] OFF ON 0 1	977
:INPut[1]:IQ:BALanced[:STATe]?	977
:INPut[1]:IQ:Q:IMPedance LOW HIGH	981
:INPut[1]:IQ:Q:IMPedance?	981

List of Commands

:INPut[1]:IQ:TYPE IQ I Q	975
:INPut[1]:IQ:TYPE?	975
:INPut[1]:IQ[:I]:IMPedance LOW HIGH	977
:INPut[1]:IQ[:I]:IMPedance?	977
:INSTrument:CATalog?	1126
:INSTrument:DEFault	149
:INSTrument:NSElect <integer>	1126
:INSTrument:NSElect?	1126
:INSTrument[:SElect] SA BASIC WCDMA CDMA2K EDGE GSM PNOISE CDMA1XEV CWLAN WIMAXOFDMA CWIMAXOFD M VSA VSA89601 LTE IDEN WIMAXFIXED LTETDD TDSCDMA NFIGURE ADEMOD DVB DTMB IS- DBT CMMB RLC SCPI LC BT	1123
:INSTrument[:SElect]?	1123
:LXI:CLOCK:PTP:ACCuracy NS25 NS100 NS250 NS1000 NS2500 US10 US25 US100 US250 US1000 US2500 MS10 MS25 MS100 MS1000 S 10 GT10S UNKNown	254
:LXI:CLOCK:PTP:ACCuracy?	254
:LXI:CLOCK:PTP:ANNounce:INTerval <interval>	255
:LXI:CLOCK:PTP:ANNounce:INTerval?	255
:LXI:CLOCK:PTP:ANNounce:RTOut <numberOfIntervals>	255
:LXI:CLOCK:PTP:ANNounce:RTOut?	255
:LXI:CLOCK:PTP:CCLass?	255
:LXI:CLOCK:PTP:DEViation?	256
:LXI:CLOCK:PTP:DOMain <domainNumber>	256
:LXI:CLOCK:PTP:DOMain?	256
:LXI:CLOCK:PTP:DRINterval <seconds>	259
:LXI:CLOCK:PTP:DRINterval?	259
:LXI:CLOCK:PTP:GMASter:ACCuracy?	259
:LXI:CLOCK:PTP:GMASter:MADdress?	260
:LXI:CLOCK:PTP:GMASter:TRACeability?	260
:LXI:CLOCK:PTP:MASter:MADdress?	260
:LXI:CLOCK:PTP:OFFSet?	256
:LXI:CLOCK:PTP:PRIOrity:FIRSt <priority>	257

List of Commands

:LXI:CLOCK:PTP:PRIority:FIRSt?	257
:LXI:CLOCK:PTP:PRIority:SECond <priority>	257
:LXI:CLOCK:PTP:PRIority:SECond?	257
:LXI:CLOCK:PTP:SINTerval <seconds>	258
:LXI:CLOCK:PTP:SINTerval?	258
:LXI:CLOCK:PTP:STATe?	257
:LXI:CLOCK:PTP:TRACeability?	258
:LXI:CLOCK:PTP:VARiance?	258
:LXI:CLOCK:SALGorithm:LOG:ALL?	263
:LXI:CLOCK:SALGorithm:LOG:CIRCular:FBENtry.	261
:LXI:CLOCK:SALGorithm:LOG:CIRCular[:ENABled] ON OFF 0 1	261
:LXI:CLOCK:SALGorithm:LOG:CIRCular[:ENABled]?	261
:LXI:CLOCK:SALGorithm:LOG:CLEar	262
:LXI:CLOCK:SALGorithm:LOG:COUNt?	262
:LXI:CLOCK:SALGorithm:LOG:ENABled ON OFF 0 1	262
:LXI:CLOCK:SALGorithm:LOG:ENABled?	262
:LXI:CLOCK:SALGorithm:LOG:ENTry? <intIndex>	263
:LXI:CLOCK:SALGorithm:LOG:SIZE <maxLogEntries>	262
:LXI:CLOCK:SALGorithm:LOG:SIZE?	262
:LXI:CLOCK:SALGorithm:LOG:STATistics:CLEar.	264
:LXI:CLOCK:SALGorithm:LOG:STATistics[:DATA]?	263
:LXI:CLOCK:SALGorithm:LOG[:NEXT]?	261
:LXI:CLOCK:SALGorithm[:SET]:ASYMmetry <seconds>	264
:LXI:CLOCK:SALGorithm[:SET]:ASYMmetry?	264
:LXI:CLOCK:SALGorithm[:SET]:CFTHreshold <secondsSquared>	264
:LXI:CLOCK:SALGorithm[:SET]:CFTHreshold?	264
:LXI:CLOCK:SALGorithm[:SET]:CIConstant <servoConstant>	265
:LXI:CLOCK:SALGorithm[:SET]:CIConstant?	265
:LXI:CLOCK:SALGorithm[:SET]:CONFigure <asymmetry>, <coarse fine threshold>, <cpc>, <cic>, <fpc>, <fic>, <maximum outlier discard>, <outlier threshold>, <set/steer threshold>	268
:LXI:CLOCK:SALGorithm[:SET]:CPConstant <servoConstant>	265

List of Commands

:LXI:CLOCK:SALGorithm[:SET]:CPConstant?	265
:LXI:CLOCK:SALGorithm[:SET]:FIConstant <servoConstant>	266
:LXI:CLOCK:SALGorithm[:SET]:FIConstant?	266
:LXI:CLOCK:SALGorithm[:SET]:FPConstant <servoConstant>	266
:LXI:CLOCK:SALGorithm[:SET]:FPConstant?	266
:LXI:CLOCK:SALGorithm[:SET]:OMAXimum <consecutiveSamples>	266
:LXI:CLOCK:SALGorithm[:SET]:OMAXimum?	266
:LXI:CLOCK:SALGorithm[:SET]:OTENable ON OFF 1 0	267
:LXI:CLOCK:SALGorithm[:SET]:OTENable?	267
:LXI:CLOCK:SALGorithm[:SET]:OTHReshold <standardDeviations>	267
:LXI:CLOCK:SALGorithm[:SET]:OTHReshold?	267
:LXI:CLOCK:SALGorithm[:SET]:STHReshold <seconds>	268
:LXI:CLOCK:SALGorithm[:SET]:STHReshold?	268
:LXI:CLOCK:SYNC:LOCAl:ENABled ON OFF 0 1	268
:LXI:CLOCK:SYNC:LOCAl:ENABled?	268
:LXI:CLOCK:SYNC:LOCAl:INTerval?	269
:LXI:CLOCK:SYNC:LOCAl:INTerval	269
:LXI:CLOCK:SYNC:MASTer?	268
:LXI:CLOCK[:TIME]:DLSavings?	251
:LXI:CLOCK[:TIME]:FRACtion <fraction>	250
:LXI:CLOCK[:TIME]:FRACtion?	250
:LXI:CLOCK[:TIME]:LOCAl?	250
:LXI:CLOCK[:TIME]:LSOOffset <integer>	251
:LXI:CLOCK[:TIME]:LSOOffset?	251
:LXI:CLOCK[:TIME]:MARKer[1] 2 3 4 5 6 7 8 9:CLEAR	252
:LXI:CLOCK[:TIME]:MARKer[1] 2 3 4 5 6 7 8 9:DELTA?	253
:LXI:CLOCK[:TIME]:MARKer[1] 2 3 4 5 6 7 8 9[:SET]	252
:LXI:CLOCK[:TIME]:MEASure:CLEAr	254
:LXI:CLOCK[:TIME]:MEASure[:DELTA]?	254
:LXI:CLOCK[:TIME]:SECOnds <seconds>	250
:LXI:CLOCK[:TIME]:SECOnds?	250

List of Commands

:LXI:CLOCK[:TIME]:TAI?	251
:LXI:CLOCK[:TIME]:TZONe?	251
:LXI:CLOCK[:TIME]:UTC?	252
:LXI:CLOCK[:TIME]:VALue <seconds>,<fractionalSeconds>	249
:LXI:CLOCK[:TIME]:VALue?	249
:LXI:EVENT:DOMain <intDomain>	238
:LXI:EVENT:DOMain?	238
:LXI:EVENT:INPut:LAN:ADD "LANEVENT"	271
:LXI:EVENT:INPut:LAN:COUNt?	275
:LXI:EVENT:INPut:LAN:DISable:ALL	271
:LXI:EVENT:INPut:LAN:FILTer "LANEVENT","filterString"	273
:LXI:EVENT:INPut:LAN:FILTer?	273
:LXI:EVENT:INPut:LAN:IDENtifier "LANEVENT","identifier"	273
:LXI:EVENT:INPut:LAN:IDENtifier? "LANEVENT"	273
:LXI:EVENT:INPut:LAN:LIST?	275
:LXI:EVENT:INPut:LAN:LOCation "LANEVENT","path"	270
:LXI:EVENT:INPut:LAN:LOCation? "LANEVENT"	271
:LXI:EVENT:INPut:LAN:REMove:ALL	272
:LXI:EVENT:INPut:LAN:REMove[:EVENT] "LANEVENT"	271
:LXI:EVENT:INPut:LAN[:SET]:CONFigure "lanEvent" , <enab> , <detection> , <filter> , <identifier>	275
:LXI:EVENT:INPut:LAN[:SET]:DETection "LANEVENT", HIGH LOW RISE FALL	273
:LXI:EVENT:INPut:LAN[:SET]:DETection? "LANEVENT"	274
:LXI:EVENT:INPut:LAN[:SET]:ENABled "LANEVENT",ON OFF 1 0	274
:LXI:EVENT:INPut:LAN[:SET]:ENABled? "LANEVENT"	275
:LXI:EVENT:LOG:ALL?	198
:LXI:EVENT:LOG:CIRCular:FBENtry	199
:LXI:EVENT:LOG:CIRCular[:ENABLE] ON OFF 1 0	196
:LXI:EVENT:LOG:CIRCular[:ENABLE]?	196
:LXI:EVENT:LOG:CLEar	197
:LXI:EVENT:LOG:COUNt?	198
:LXI:EVENT:LOG:ENABle ON OFF 1 0	197

List of Commands

:LXI:EVENT:LOG:ENABLE?	197
:LXI:EVENT:LOG:ENTRy? <intIndex>	199
:LXI:EVENT:LOG:SIZE <size>	197
:LXI:EVENT:LOG:SIZE?	197
:LXI:EVENT:LOG[:NEXT]?	198
:LXI:EVENT:STATus[:ENABled] "STATUSEVENT",ON OFF 1 0	270
:LXI:EVENT:STATus[:ENABled]? "STATUSEVENT"	270
:LXI:EVENT[:OUTPut]:LAN:ADD "LANEVENT"	239
:LXI:EVENT[:OUTPut]:LAN:COUNT?	245
:LXI:EVENT[:OUTPut]:LAN:DISAbLe:ALL	239
:LXI:EVENT[:OUTPut]:LAN:LIST?	239
:LXI:EVENT[:OUTPut]:LAN:REMOve:ALL	240
:LXI:EVENT[:OUTPut]:LAN:REMOve[:EVENT] "LANEVENT"	240
:LXI:EVENT[:OUTPut]:LAN:SEND "LANEVENT", RISE FALL	245
:LXI:EVENT[:OUTPut]:LAN[:SET]:CONFIgure "lanEvent",<enabled>,<source>,<slope>,<drive>,<destination> 245	
:LXI:EVENT[:OUTPut]:LAN[:SET]:DESTination "LANEVENT", "destinationExpression"	242
:LXI:EVENT[:OUTPut]:LAN[:SET]:DESTination? "LANEVENT"	242
:LXI:EVENT[:OUTPut]:LAN[:SET]:DRIVE "LANEVENT", OFF NORMal WOR	242
:LXI:EVENT[:OUTPut]:LAN[:SET]:DRIVE? "LANEVENT"	242
:LXI:EVENT[:OUTPut]:LAN[:SET]:ENABled "LANEVENT",ON OFF 1 0	244
:LXI:EVENT[:OUTPut]:LAN[:SET]:ENABled? "LANEVENT"	244
:LXI:EVENT[:OUTPut]:LAN[:SET]:IDENtifier "LANEVENT", "identifier"	246
:LXI:EVENT[:OUTPut]:LAN[:SET]:IDENtifier? "LANEVENT"	246
:LXI:EVENT[:OUTPut]:LAN[:SET]:SLOPe "LANEVENT", POSitive NEGative	244
:LXI:EVENT[:OUTPut]:LAN[:SET]:SLOPe? "LANEVENT"	244
:LXI:EVENT[:OUTPut]:LAN[:SET]:SOURce "LANEVENT", "SourceEvent"	241
:LXI:EVENT[:OUTPut]:LAN[:SET]:SOURce? "LANEVENT"	241
:LXI:EVENT[:OUTPut]:LAN[:SET]:TSDelta "LANEVENT", <seconds>	244
:LXI:EVENT[:OUTPut]:LAN[:SET]:TSDelta? "LANEVENT"	244
:MEASure:ACP[n]?	367

List of Commands

:MEASure:CHPower:CHPower?	295
:MEASure:CHPower:DENSity?	295
:MEASure:CHPower[n]?	295
:MEASure:MONitor[n]?	791
:MEASure:OBWidth [n]?	735
:MEASure:OBWidth:FERRor?	735
:MEASure:OBWidth:OBWidth?	735
:MEASure:OBWidth:XDB?	735
:MEASure:SEMAsk[n]?	523
:MEASure:WAVEform[n]	839
:MEMMory:RDIRECTory <directory_name>	190
:MEMMory:CATalog? [<directory_name>]	188
:MEMMory:CDIRECTory [<directory_name>].	188
:MEMMory:CDIRECTory?	188
:MEMMory:COPIY <string>,<string>[,<string>,<string>]	188
:MEMMory:DATA <file_name>, <data>	189
:MEMMory:DATA? <file_name>	189
:MEMMory:DELeTe <file_name>[,<directory_name>]	189
:MEMMory:LOAD:CORRection 1 2 3 4, <filename>.	1159
:MEMMory:LOAD:STATe <filename>	156
:MEMMory:LOAD:TRACe TRACE1 TRACE2 TRACE3 TRACE4 TRACE5 TRACE6,<filename>	159
:MEMMory:LOAD:TRACe:DATA TRACE1 TRACE2 TRACE3 TRACE4 TRACE5 TRACE6,<filename>	161
:MEMMory:LOAD:TRACe:REGister TRACE1 TRACE2 TRACE3 TRACE4 TRACE5 TRACE6,<integer>	159
:MEMMory:MDIRECTory <directory_name>	190
:MEMMory:MOVE <string>,<string>[,<string>,<string>]	190
:MEMMory:STORE:CORRection 1 2 3 4, <filename>	1165
:MEMMory:STORE:SCReen <filename>	185
:MEMMory:STORE:SCReen:THEMe TDColor TDMonochrome FCOLor FMONochrome	183
:MEMMory:STORE:SCReen:THEMe?	183
:MEMMory:STORE:STATe <filename>	173
:MEMMory:STORE:TRACe TRACE1 TRACE2 TRACE3 TRACE4 TRACE5 TRACE6 ALL,<filename>	176

List of Commands

:MMEMory:STORe:TRACe:DATA TRACE1 TRACE2 TRACE3 TRACE4 TRACE5 TRACE6 ALL,<filename>	
177	
:MMEMory:STORe:TRACe:REGister TRACE1 TRACE2 TRACE3 TRACE4 TRACE5 TRACE6 ALL,<integer>	
176	
:OUTPut:ANALog OFF SVIDeo LOGVideo LINVideo DAUDio	1030
:OUTPut:ANALog?	1030
:OUTPut:AUX SIF AIF LOGVideo OFF.	1036
:OUTPut:AUX:AIF <value>	1038
:OUTPut:AUX:AIF?	1038
:OUTPut:AUX?	1036
:OUTPut:DBUS[1][:STATe] ON OFF 1 0	1036
:OUTPut:DBUS[1][:STATe]?	1036
:OUTPut:IQ:OUTPut IQ1 IQ250 OFF.	1034
:OUTPut:IQ:OUTPut?	1034
:READ:ACP[n]?	367
:READ:CHPower:CHPower?	295
:READ:CHPower:DENSity	295
:READ:CHPower[n]?	295
:READ:MONitor[n]?	791
:READ:OBWidth [n]?	735
:READ:OBWidth:FERRor?	735
:READ:OBWidth:OBWidth?	735
:READ:OBWidth:XDB?	735
:READ:PSStatistic[n]?	479
:READ:SEMAsk[n]?	523
:READ:WAVeform[n]	839
:SOURce:NOISe:SNS:ATTached?	1121
:SOURce:NOISe:TYPE NORMAl SNS.	1120
:SOURce:NOISe:TYPE?	1120
:SOURce:NOISe[:STATe] ON OFF 1 0.	1121
:SOURce:NOISe[:STATe]?	1121
:SYSTem:APPLication:CATalog:OPTion? <model>	1129

List of Commands

:SYSTem:APPLication:CATalog:REVision? <model>	1129
:SYSTem:APPLication:CATalog[:NAME]:COUNT?	1128
:SYSTem:APPLication:CATalog[:NAME]?	1128
:SYSTem:APPLication[:CURRent]:OPTion?	1128
:SYSTem:APPLication[:CURRent]:REVision?	1127
:SYSTem:APPLication[:CURRent][:NAME]?	1127
:SYSTem:COMMunicate:GPIB[1][:SELF]:ADDRes <integer>	233
:SYSTem:COMMunicate:GPIB[1][:SELF]:ADDRes?	233
:SYSTem:COMMunicate:GPIB[1][:SELF]:CONTRoller[:ENABle] ON OFF 0 1	234
:SYSTem:COMMunicate:GPIB[1][:SELF]:CONTRoller[:ENABle]?	234
:SYSTem:COMMunicate:LAN:SCPI:SIcL:ENABle OFF ON 0 1	236
:SYSTem:COMMunicate:LAN:SCPI:SIcL:ENABle?	236
:SYSTem:COMMunicate:LAN:SCPI:SOCKet:CONTRol?	236
:SYSTem:COMMunicate:LAN:SCPI:SOCKet:ENABle OFF ON 0 1	235
:SYSTem:COMMunicate:LAN:SCPI:SOCKet:ENABle?	235
:SYSTem:COMMunicate:LAN:SCPI:TELNet:ENABle OFF ON 0 1	235
:SYSTem:COMMunicate:LAN:SCPI:TELNet:ENABle?	235
:SYSTem:COMMunicate:USB:CONNecTion?	247
:SYSTem:COMMunicate:USB:PACKets?	248
:SYSTem:COMMunicate:USB:STATus?	248
:SYSTem:DATE “<year>,<month>,<day>”	290
:SYSTem:DATE?	290
:SYSTem:DEFault [ALL] ALIGn INPut MISC MODEs PON	276
:SYSTem:ERRor:VERBose OFF ON 0 1	193
:SYSTem:ERRor:VERBose?	193
:SYSTem:ERRor[:NEXT]?	192
:SYSTem:HELP:HEADers?	289
:SYSTem:HID?	283
:SYSTem:IDN <string>	246
:SYSTem:IDN?	246
:SYSTem:KLOCK OFF ON 0 1	289

List of Commands

:SYSTem:KLOCK?	289
:SYSTem:LKEY <"OptionInfo">, <"LicenseInfo">	281
:SYSTem:LKEY:DELete <"OptionInfo">,<"LicenseInfo">	282
:SYSTem:LKEY:LIST?	282
:SYSTem:LKEY? <"OptionInfo">	283
:SYSTem:MRELay:COUNT?	286
:SYSTem:OPTions?	288
:SYSTem:PON:APPLication:LLISt <string of INSTRument:SElect names>	205
:SYSTem:PON:APPLication:LLISt?	205
:SYSTem:PON:APPLication:VMEMory:TOTal?	206
:SYSTem:PON:APPLication:VMEMory:USED:NAME? <INSTRument:SElect name>	207
:SYSTem:PON:APPLication:VMEMory:USED?	206
:SYSTem:PON:APPLication:VMEMory[::AVAILable]?	206
:SYSTem:PON:ETIME?	287
:SYSTem:PON:MODE SA BASIC ADEMOD NFIGURE PNOISE CDMA2K TDSCDMA VSA VSA89601 WCDMA WIMAXOFDMA	201
:SYSTem:PON:MODE?	201
:SYSTem:PON:TIME?	219
:SYSTem:PON:TYPE MODE USER LAST PRESet	199
:SYSTem:PON:TYPE?	199
:SYSTem:PRESet.	147
:SYSTem:PRESet:USER	291
:SYSTem:PRESet:USER:ALL	292
:SYSTem:PRESet:USER:SAVE	293
:SYSTem:PRINt:THEMe TDColor TDMonochrome FCOLOR FMONochrome.	145
:SYSTem:PRINt:THEMe?	145
:SYSTem:PUP:PROCCess	204
:SYSTem:SECurity:USB:WPRotect[::ENABLE] ON OFF 0 1	284
:SYSTem:SECurity:USB:WPRotect[::ENABLE]?	284
:SYSTem:SHOW OFF ERRor SYSTem HARDware LXI HWSTATistics ALIGNment SOFTware CAPPLication	191
:SYSTem:SHOW?	191

List of Commands

:SYSTem:TEMPerature:HEXTreme?	287
:SYSTem:TEMPerature:LEXTreme?	286
:SYSTem:TIME "<hour>,<minute>,<second>"	290
:SYSTem:TIME?	290
:SYSTem:VERSion?	289
:TRACe:CHPower:TYPE WRITe AVERAge MAXHold MINHold	350
:TRACe:CHPower:TYPE?	350
:TRACe:CLEar TRACE1 TRACE2 TRACE3 TRACE4 TRACE5 TRACE6	1231
:TRACe:CLEar:ALL	1232
:TRACe:COpy TRACE1 TRACE2 TRACE3 TRACE4 TRACE5 TRACE6, TRACE1 TRACE2 TRACE3 TRACE4 TRACE5 TRACE6	1245
:TRACe:COpy?	1245
:TRACe:EXCHange TRACE1 TRACE2 TRACE3 TRACE4 TRACE5 TRACE6, TRACE1 TRACE2 TRACE3 TRACE4 TRACE5 TRACE6	1246
:TRACe:EXCHange?	1246
:TRACe:MATH:MEAN? TRACE1 TRACE2 TRACE3 TRACE4 TRACE5 TRACE6	1250
:TRACe:MATH:SMOoth TRACE1 TRACE2 TRACE3 TRACE4 TRACE5 TRACE6	1249
:TRACe:MATH:SMOoth:POINts <integer>	1249
:TRACe:MATH:SMOoth:POINts?	1249
:TRACe:MONitor:CLEar [TRACE1] TRACE2 TRACE3	835
:TRACe:MONitor:CLEar:ALL	835
:TRACe:OBWidth:TYPE WRITe AVERAge MAXHold MINHold	781
:TRACe:OBWidth:TYPE?	781
:TRACe:SEMAsk:TYPE WRITe AVERAge MAXHold MINHold	606
:TRACe:SEMAsk:TYPE?	606
:TRACe[:DATA] TRACE1 TRACE2 TRACE3 TRACE4 TRACE5 TRACE6, <data>	1247
:TRACe[:DATA]? TRACE1 TRACE2 TRACE3 TRACE4 TRACE5 TRACE6	1248
:TRACe[1] 2 3:ACPower:DISPlay[:STATe] ON OFF 0 1	467
:TRACe[1] 2 3:ACPower:DISPlay[:STATe]?	467
:TRACe[1] 2 3:ACPower:TYPE WRITe AVERAge MAXHold MINHold	465
:TRACe[1] 2 3:ACPower:TYPE?	465
:TRACe[1] 2 3:ACPower:UPDate[:STATe] ON OFF 0 1	467

List of Commands

:TRACe[1] 2 3:ACPower:UPDate[:STATe]?	467
:TRACe[1] 2 3:MONitor:DISPlay[:STATe] ON OFF 0 1	832
:TRACe[1] 2 3:MONitor:DISPlay[:STATe]?	832
:TRACe[1] 2 3:MONitor:TYPE WRITe AVERAge MAXHold MINHold	831
:TRACe[1] 2 3:MONitor:TYPE?	831
:TRACe[1] 2 3:MONitor:UPDate[:STATe] ON OFF 0 1	832
:TRACe[1] 2 3:MONitor:UPDate[:STATe]?	832
:TRACe[1] 2 3 4 5 6:DISPlay[:STATe] ON OFF 0 1	1219
:TRACe[1] 2 3 4 5 6:DISPlay[:STATe]?	1219
:TRACe[1] 2 3 4 5 6:TYPE WRITe AVERAge MAXHold MINHold	1211
:TRACe[1] 2 3 4 5 6:TYPE?	1211
:TRACe[1] 2 3 4 5 6:UPDate[:STATe] ON OFF 0 1	1219
:TRACe[1] 2 3 4 5 6:UPDate[:STATe]?	1219
:TRIGger:<measurement>[:SEquence]:IQ:SOURce EXTernal1 EXTernal2 IMMediate IQMag IDEMod QDE-Mod IINPut QINPut AIQMag	1258
:TRIGger:<measurement>[:SEquence]:IQ:SOURce?	1258
:TRIGger:<measurement>[:SEquence]:RF:SOURce EXTernal1 EXTernal2 IMMediate LINE FRAME RFBurst VIDeo IF ALARm LAN	1256
:TRIGger:<measurement>[:SEquence]:RF:SOURce?	1256
:TRIGger:<measurement>[:SEquence]:SOURce EXTernal1 EXTernal2 IMMediate LINE FRAME RFBurst VIDeo IF ALARm LAN IQMag IDEMod QDEMod IINPut QINPut AIQMag	1251
:TRIGger:<measurement>[:SEquence]:SOURce?	1251
:TRIGger[:SEquence]:AIQMag:BANDwidth <freq>	1308
:TRIGger[:SEquence]:AIQMag:BANDwidth?	1308
:TRIGger[:SEquence]:AIQMag:CENTer <freq>	1307
:TRIGger[:SEquence]:AIQMag:CENTer?	1307
:TRIGger[:SEquence]:AIQMag:DELay <time>	1307
:TRIGger[:SEquence]:AIQMag:DELay:STATe OFF ON 0 1	1307
:TRIGger[:SEquence]:AIQMag:DELay:STATe?	1307
:TRIGger[:SEquence]:AIQMag:DELay?	1307
:TRIGger[:SEquence]:AIQMag:LEVel <ampl >	1306
:TRIGger[:SEquence]:AIQMag:LEVel?	1306

List of Commands

:TRIGger[:SEQuence]:AIQMag:SLOPe POSitive NEGative	1307
:TRIGger[:SEQuence]:AIQMag:SLOPe?	1307
:TRIGger[:SEQuence]:ATRigger <time>	1309
:TRIGger[:SEQuence]:ATRigger:STATe OFF ON 0 1	1309
:TRIGger[:SEQuence]:ATRigger:STATe?	1309
:TRIGger[:SEQuence]:ATRigger?	1309
:TRIGger[:SEQuence]:EXTernal1:DELay <time>	1267
:TRIGger[:SEQuence]:EXTernal1:DELay:STATe OFF ON 0 1	1267
:TRIGger[:SEQuence]:EXTernal1:DELay:STATe?	1267
:TRIGger[:SEQuence]:EXTernal1:DELay?	1267
:TRIGger[:SEQuence]:EXTernal1:LEVel <level>	1266
:TRIGger[:SEQuence]:EXTernal1:LEVel?	1266
:TRIGger[:SEQuence]:EXTernal1:SLOPe POSitive NEGative	1266
:TRIGger[:SEQuence]:EXTernal1:SLOPe?	1266
:TRIGger[:SEQuence]:EXTernal2:DELay <time>	1270
:TRIGger[:SEQuence]:EXTernal2:DELay:STATe OFF ON 0 1	1270
:TRIGger[:SEQuence]:EXTernal2:DELay:STATe?	1270
:TRIGger[:SEQuence]:EXTernal2:DELay?	1270
:TRIGger[:SEQuence]:EXTernal2:LEVel	1269
:TRIGger[:SEQuence]:EXTernal2:LEVel?	1269
:TRIGger[:SEQuence]:EXTernal2:SLOPe POSitive NEGative	1269
:TRIGger[:SEQuence]:EXTernal2:SLOPe?	1269
:TRIGger[:SEQuence]:FRAMe:ADJust <time>	1278
:TRIGger[:SEQuence]:FRAMe:DELay <time>	1282
:TRIGger[:SEQuence]:FRAMe:DELay:STATe OFF ON 0 1	1282
:TRIGger[:SEQuence]:FRAMe:DELay:STATe?	1282
:TRIGger[:SEQuence]:FRAMe:DELay?	1282
:TRIGger[:SEQuence]:FRAMe:OFFSet <time>	1277
:TRIGger[:SEQuence]:FRAMe:OFFSet:DISPlay:RESet	1279
:TRIGger[:SEQuence]:FRAMe:OFFSet?	1277
:TRIGger[:SEQuence]:FRAMe:PERiod <time>	1276

List of Commands

:TRIGger[:SEQuence]:FRAMe:PERiod?	1276
:TRIGger[:SEQuence]:FRAMe:SYNC EXTernal1 EXTernal2 RFBurst OFF	1279
:TRIGger[:SEQuence]:FRAMe:SYNC:HOLDoff <time>	1282
:TRIGger[:SEQuence]:FRAMe:SYNC:HOLDoff:STATe OFF ON 0 1	1282
:TRIGger[:SEQuence]:FRAMe:SYNC:HOLDoff:STATe?	1282
:TRIGger[:SEQuence]:FRAMe:SYNC:HOLDoff?	1282
:TRIGger[:SEQuence]:FRAMe:SYNC?	1279
:TRIGger[:SEQuence]:HOLDoff <time>	1310
:TRIGger[:SEQuence]:HOLDoff:STATe OFF ON 0 1	1310
:TRIGger[:SEQuence]:HOLDoff:STATe?	1310
:TRIGger[:SEQuence]:HOLDoff:TYPE NORMAl ABOVe BELow	1311
:TRIGger[:SEQuence]:HOLDoff:TYPE?	1311
:TRIGger[:SEQuence]:HOLDoff?	1310
:TRIGger[:SEQuence]:IDEMod:DELay <time>	1301
:TRIGger[:SEQuence]:IDEMod:DELay:STATe OFF ON 0 1	1301
:TRIGger[:SEQuence]:IDEMod:DELay:STATe?	1301
:TRIGger[:SEQuence]:IDEMod:DELay?	1301
:TRIGger[:SEQuence]:IDEMod:LEVel <voltage>	1300
:TRIGger[:SEQuence]:IDEMod:LEVel?	1300
:TRIGger[:SEQuence]:IDEMod:SLOPe POSitive NEGative	1301
:TRIGger[:SEQuence]:IDEMod:SLOPe?	1301
:TRIGger[:SEQuence]:IINPut:DELay <time>	1304
:TRIGger[:SEQuence]:IINPut:DELay:STATe OFF ON 0 1	1304
:TRIGger[:SEQuence]:IINPut:DELay:STATe?	1304
:TRIGger[:SEQuence]:IINPut:DELay?	1304
:TRIGger[:SEQuence]:IINPut:LEVel <voltage>	1303
:TRIGger[:SEQuence]:IINPut:LEVel?	1303
:TRIGger[:SEQuence]:IINPut:SLOPe POSitive NEGative	1304
:TRIGger[:SEQuence]:IINPut:SLOPe?	1304
:TRIGger[:SEQuence]:IQMag:DELay <time>	1300
:TRIGger[:SEQuence]:IQMag:DELay:STATe OFF ON 0 1	1300

List of Commands

:TRIGger[:SEquence]:IQMag:DELay:STATe?	1300
:TRIGger[:SEquence]:IQMag:DELay?	1300
:TRIGger[:SEquence]:IQMag:LEVel <ampl >	1299
:TRIGger[:SEquence]:IQMag:LEVel?	1299
:TRIGger[:SEquence]:IQMag:SLOPe POSitive NEGative	1299
:TRIGger[:SEquence]:IQMag:SLOPe?	1299
:TRIGger[:SEquence]:LINE:DELay <time>	1264
:TRIGger[:SEquence]:LINE:DELay:STATe OFF ON 0 1	1264
:TRIGger[:SEquence]:LINE:DELay:STATe?	1264
:TRIGger[:SEquence]:LINE:DELay?	1264
:TRIGger[:SEquence]:LINE:SLOPe POSitive NEGative	1264
:TRIGger[:SEquence]:LINE:SLOPe?	1264
:TRIGger[:SEquence]:LXI:ALARm:DISable:ALL	1290
:TRIGger[:SEquence]:LXI:ALARm:LIST?	1290
:TRIGger[:SEquence]:LXI:ALARm[:SET]:CONFigure "alarmEvent", <enable>, <epochSeconds>, <epochFraction>, <period>, <repeat>	1298
:TRIGger[:SEquence]:LXI:ALARm[:SET]:ENABled "alarmEvent",ON OFF 1 0	1297
:TRIGger[:SEquence]:LXI:ALARm[:SET]:ENABled? "alarmEvent"	1297
:TRIGger[:SEquence]:LXI:ALARm[:SET]:PERiod "alarmEvent",<seconds>	1296
:TRIGger[:SEquence]:LXI:ALARm[:SET]:PERiod? "alarmEvent"	1296
:TRIGger[:SEquence]:LXI:ALARm[:SET]:REPeat "alarmEvent",<repetitions>	1296
:TRIGger[:SEquence]:LXI:ALARm[:SET]:REPeat? "alarmEvent"	1297
:TRIGger[:SEquence]:LXI:ALARm[:SET]:TIME:SEConds "alarmEvent",<seconds>	1294
:TRIGger[:SEquence]:LXI:ALARm[:SET]:TIME:SEConds? "alarmEvent"	1294
:TRIGger[:SEquence]:LXI:ALARm[:SET]:TIME[:VALue] "alarmEvent",<seconds>, <fractionalSeconds>	1293
:TRIGger[:SEquence]:LXI:ALARm[:SET]:TIME[:VALue]:ABSolute "alarmEvent","date","time"	1291
:TRIGger[:SEquence]:LXI:ALARm[:SET]:TIME[:VALue]:ABSolute? "alarmEvent"	1291
:TRIGger[:SEquence]:LXI:ALARm[:SET]:TIME[:VALue]:FRACTION "alarmEvent",<fractionalSeconds>	1295
:TRIGger[:SEquence]:LXI:ALARm[:SET]:TIME[:VALue]:FRACTION? "alarmEvent"	1295
:TRIGger[:SEquence]:LXI:ALARm[:SET]:TIME[:VALue]:RELative "alarmEvent",<seconds>	1295
:TRIGger[:SEquence]:LXI:ALARm[:SET]:TIME[:VALue]:RELative? "alarmEvent"	1296

List of Commands

:TRIGger[:SEQuence]:LXI:ALARm[:SET]:TIME[:VALue]?	1293
:TRIGger[:SEQuence]:LXI:LAN:ADD "LANEVENT"	1286
:TRIGger[:SEQuence]:LXI:LAN:COUNT?	1288
:TRIGger[:SEQuence]:LXI:LAN:DISable:ALL	1283
:TRIGger[:SEQuence]:LXI:LAN:LIST?	1284
:TRIGger[:SEQuence]:LXI:LAN:REMOve:ALL	1287
:TRIGger[:SEQuence]:LXI:LAN:REMOve[:EVENT] "LANEVENT"	1287
:TRIGger[:SEQuence]:LXI:LAN[:SET]:CONFigure "lanEvent", <enable>, <detection>, <delay>, <filter>, <identi- fier>	1289
:TRIGger[:SEQuence]:LXI:LAN[:SET]:DELay "LANEVENT", <time>	1285
:TRIGger[:SEQuence]:LXI:LAN[:SET]:DELay? "lanEvent"	1285
:TRIGger[:SEQuence]:LXI:LAN[:SET]:DETection "LANEVENT", HIGH LOW RISE FALL	1284
:TRIGger[:SEQuence]:LXI:LAN[:SET]:DETection? "LANEVENT"	1285
:TRIGger[:SEQuence]:LXI:LAN[:SET]:ENABled "LANEVENT", ON OFF 1 0	1286
:TRIGger[:SEQuence]:LXI:LAN[:SET]:ENABled? "LANEVENT"	1286
:TRIGger[:SEQuence]:LXI:LAN[:SET]:FILTer "LANEVENT", "filterString"	1288
:TRIGger[:SEQuence]:LXI:LAN[:SET]:FILTer?	1288
:TRIGger[:SEQuence]:LXI:LAN[:SET]:IDENtifier "LANEVENT", "identifier"	1288
:TRIGger[:SEQuence]:LXI:LAN[:SET]:IDENtifier? "LANEVENT"	1288
:TRIGger[:SEQuence]:OFFSet <time>	1311
:TRIGger[:SEQuence]:OFFSet:STATe OFF ON 0 1	1311
:TRIGger[:SEQuence]:OFFSet:STATe?	1311
:TRIGger[:SEQuence]:OFFSet?	1311
:TRIGger[:SEQuence]:QDEMod:DELay <time>	1303
:TRIGger[:SEQuence]:QDEMod:DELay:STATe OFF ON 0 1	1303
:TRIGger[:SEQuence]:QDEMod:DELay:STATe?	1303
:TRIGger[:SEQuence]:QDEMod:DELay?	1303
:TRIGger[:SEQuence]:QDEMod:LEVel <voltage>	1302
:TRIGger[:SEQuence]:QDEMod:LEVel?	1302
:TRIGger[:SEQuence]:QDEMod:SLOPe POSitive NEGative	1302
:TRIGger[:SEQuence]:QDEMod:SLOPe?	1302

List of Commands

:TRIGger[:SEQuence]:QINPut:DELay <time>	1306
:TRIGger[:SEQuence]:QINPut:DELay:STATe OFF ON 0 1	1306
:TRIGger[:SEQuence]:QINPut:DELay:STATe?	1306
:TRIGger[:SEQuence]:QINPut:DELay?	1306
:TRIGger[:SEQuence]:QINPut:LEVel <voltage>	1305
:TRIGger[:SEQuence]:QINPut:LEVel?	1305
:TRIGger[:SEQuence]:QINPut:SLOPe POSitive NEGative	1305
:TRIGger[:SEQuence]:QINPut:SLOPe?	1305
:TRIGger[:SEQuence]:RFBurst:DELay <time>	1274
:TRIGger[:SEQuence]:RFBurst:DELay:STATe OFF ON 0 1	1274
:TRIGger[:SEQuence]:RFBurst:DELay:STATe?	1274
:TRIGger[:SEQuence]:RFBurst:DELay?	1274
:TRIGger[:SEQuence]:RFBurst:LEVel:ABSolute <ampl>	1271
:TRIGger[:SEQuence]:RFBurst:LEVel:ABSolute?	1271
:TRIGger[:SEQuence]:RFBurst:LEVel:RELative <rel_ampl>	1273
:TRIGger[:SEQuence]:RFBurst:LEVel:RELative?	1273
:TRIGger[:SEQuence]:RFBurst:LEVel:TYPE ABSolute RELative	1272
:TRIGger[:SEQuence]:RFBurst:LEVel:TYPE?	1272
:TRIGger[:SEQuence]:RFBurst:SLOPe POSitive NEGative	1273
:TRIGger[:SEQuence]:RFBurst:SLOPe?	1273
:TRIGger[:SEQuence]:VIDeo:DELay <time>	1262
:TRIGger[:SEQuence]:VIDeo:DELay:STATe OFF ON 0 1	1262
:TRIGger[:SEQuence]:VIDeo:DELay:STATe?	1262
:TRIGger[:SEQuence]:VIDeo:DELay?	1262
:TRIGger[:SEQuence]:VIDeo:LEVel <ampl>	1261
:TRIGger[:SEQuence]:VIDeo:LEVel?	1261
:TRIGger[:SEQuence]:VIDeo:SLOPe POSitive NEGative	1262
:TRIGger[:SEQuence]:VIDeo:SLOPe?	1262
:TRIGger TRIGger1 TRIGger2[:SEQuence]:OUTPut HSWP MEASuring MAIN GATE GTRigger OEV- en SPOint SSWeep SSETtled S1Marker S2Marker S3Marker S4Marker OFF	1027
:TRIGger TRIGger1 TRIGger2[:SEQuence]:OUTPut:POLarity POSitive NEGative	1027

List of Commands

:TRIGger TRIGger1 TRIGger2[:SEQuence]:OUTPut:POLarity?	1027
:TRIGger TRIGger1 TRIGger2[:SEQuence]:OUTPut?	1027
:TRIGger1 TRIGger[:SEQuence]:LXI:ALARm:COUNT?	1298
:UNIT:ACPower:POWer:PSD DBMHZ DBMMHZ	440
:UNIT:ACPower:POWer:PSD?	440
:UNIT:CHPower:POWer:PSD DBMHZ DBMMHZ	331
:UNIT:CHPower:POWer:PSD?	331
:UNIT:POWer DBM DBMV DBMA V W A DBUV DBUA DBUVM DBUAM DBPT DBG	929
:UNIT:POWer?	929
[:SENSe]:<measurement>:TRIGger:SOURce	1252
[:SENSe]:ACPower:AVERage:COUNt <integer>	402
[:SENSe]:ACPower:AVERage:COUNt?	402
[:SENSe]:ACPower:AVERage:TCONtrol EXPonential REPeat	403
[:SENSe]:ACPower:AVERage:TCONtrol?	403
[:SENSe]:ACPower:AVERage[:STATe] OFF ON 0 1	402
[:SENSe]:ACPower:AVERage[:STATe]?	402
[:SENSe]:ACPower:BANDwidth:SHAPE GAUSSian FLATop	387
[:SENSe]:ACPower:BANDwidth:SHAPE?	387
[:SENSe]:ACPower:BANDwidth:TYPE DB3 DB6	388
[:SENSe]:ACPower:BANDwidth:TYPE?	388
[:SENSe]:ACPower:BANDwidth:VIDeo <freq>	385
[:SENSe]:ACPower:BANDwidth:VIDeo:AUTO OFF ON 0 1	385
[:SENSe]:ACPower:BANDwidth:VIDeo:AUTO?	385
[:SENSe]:ACPower:BANDwidth:VIDeo?	385
[:SENSe]:ACPower:BANDwidth[:RESolution] <bandwidth>	384
[:SENSe]:ACPower:BANDwidth[:RESolution]:AUTO ON OFF 1 0	384
[:SENSe]:ACPower:BANDwidth[:RESolution]:AUTO?	384
[:SENSe]:ACPower:BANDwidth[:RESolution]?	384
[:SENSe]:ACPower:CARRier[1] 2:AUTO[:STATe] OFF ON 0 1	407
[:SENSe]:ACPower:CARRier[1] 2:AUTO[:STATe]?	407
[:SENSe]:ACPower:CARRier[1] 2:COUNt <integer>	404

List of Commands

[[:SENSe]:ACPower:CARRier[1]2:COUNT?	404
[[:SENSe]:ACPower:CARRier[1]2:CPSD <real>	408
[[:SENSe]:ACPower:CARRier[1]2:CPSD?	408
[[:SENSe]:ACPower:CARRier[1]2:LIST:BANDwidth[:INTegration] <freq>,	412
[[:SENSe]:ACPower:CARRier[1]2:LIST:BANDwidth[:INTegration]?	412
[[:SENSe]:ACPower:CARRier[1]2:LIST:COUPle OFF ON 0 1,	409
[[:SENSe]:ACPower:CARRier[1]2:LIST:COUPle?	409
[[:SENSe]:ACPower:CARRier[1]2:LIST:FILTer:ALPHA <real>,	415
[[:SENSe]:ACPower:CARRier[1]2:LIST:FILTer:ALPHA?	415
[[:SENSe]:ACPower:CARRier[1]2:LIST:FILTer[:RRC][:STATe] ON OFF 1 0,	414
[[:SENSe]:ACPower:CARRier[1]2:LIST:FILTer[:RRC][:STATe]?	414
[[:SENSe]:ACPower:CARRier[1]2:LIST:METHod IBW RRC,	445
[[:SENSe]:ACPower:CARRier[1]2:LIST:METHod?	445
[[:SENSe]:ACPower:CARRier[1]2:LIST:PPResent YES NO,	410
[[:SENSe]:ACPower:CARRier[1]2:LIST:PPResent?	410
[[:SENSe]:ACPower:CARRier[1]2:LIST:WIDTh <bandwidth>,	411
[[:SENSe]:ACPower:CARRier[1]2:LIST:WIDTh?	411
[[:SENSe]:ACPower:CARRier[1]2:RCARrier <integer>	404
[[:SENSe]:ACPower:CARRier[1]2:RCARrier:AUTO OFF ON 0 1	404
[[:SENSe]:ACPower:CARRier[1]2:RCARrier:AUTO?	404
[[:SENSe]:ACPower:CARRier[1]2:RCARrier?	404
[[:SENSe]:ACPower:CARRier[1]2:RCFRequency <freq>	405
[[:SENSe]:ACPower:CARRier[1]2:RCFRequency:AUTO OFF ON 0 1	405
[[:SENSe]:ACPower:CARRier[1]2:RCFRequency:AUTO?	405
[[:SENSe]:ACPower:CARRier[1]2:RCFRequency?	405
[[:SENSe]:ACPower:CARRier[1]2[:POWER] <real>	407
[[:SENSe]:ACPower:CARRier[1]2[:POWER]?	407
[[:SENSe]:ACPower:CORRection:NOISe[:AUTO] OFF ON 0 1	442
[[:SENSe]:ACPower:CORRection:NOISe[:AUTO]?	442
[[:SENSe]:ACPower:DETEctor:AUTO ON OFF 1 0	468
[[:SENSe]:ACPower:DETEctor:AUTO?	468

List of Commands

[[:SENSe]:ACPower:DETEctor[:FUNction] AVERAge NEGative NORMal POSitive SAMPLE.....	469
[[:SENSe]:ACPower:DETEctor[:FUNction]?	469
[[:SENSe]:ACPower:FILTer[:RRC]:ALPHa <real>.....	445
[[:SENSe]:ACPower:FILTer[:RRC]:ALPHa?.....	445
[[:SENSe]:ACPower:FILTer[:RRC][:STATe] OFF ON 0 1.....	444
[[:SENSe]:ACPower:FILTer[:RRC][:STATe]?	444
[[:SENSe]:ACPower:FREQUency:SPAN <freq>	457
[[:SENSe]:ACPower:FREQUency:SPAN:FULL	458
[[:SENSe]:ACPower:FREQUency:SPAN:PREVious	459
[[:SENSe]:ACPower:FREQUency:SPAN?	457
[[:SENSe]:ACPower:FREQUency:SYNThesis:AUTO[:STATe] OFF ON 0 1	437
[[:SENSe]:ACPower:FREQUency:SYNThesis:AUTO[:STATe]?.....	437
[[:SENSe]:ACPower:FREQUency:SYNThesis[:STATe] 1 2 3	437
[[:SENSe]:ACPower:FREQUency:SYNThesis[:STATe]?.....	437
[[:SENSe]:ACPower:METHod IBW IBWRange FAST RBW	439
[[:SENSe]:ACPower:METHod?.....	439
[[:SENSe]:ACPower:OFFSet[1] 2:LIST:ABSolute <real>, <real>, <real>, <real>, <real>, <real>	425
[[:SENSe]:ACPower:OFFSet[1] 2:LIST:ABSolute?	425
[[:SENSe]:ACPower:OFFSet[1] 2:LIST:BANDwidth:RESolution <bandwidth>, <bandwidth>, <bandwidth>, <bandwidth>, <bandwidth>, <bandwidth>	420
[[:SENSe]:ACPower:OFFSet[1] 2:LIST:BANDwidth:RESolution:AUTO ON OFF 1 0, ON OFF 1 0, ON OFF 1 0, ON OFF 1 0, ON OFF 1 0, ON OFF 1 0.....	420
[[:SENSe]:ACPower:OFFSet[1] 2:LIST:BANDwidth:RESolution:AUTO?	420
[[:SENSe]:ACPower:OFFSet[1] 2:LIST:BANDwidth:RESolution?	420
[[:SENSe]:ACPower:OFFSet[1] 2:LIST:BANDwidth:SHAPE GAUSSian FLATtop, GAUSSian FLATtop, GAUSSian FLATtop, GAUSSian FLATtop, GAUSSian FLATtop, GAUSSian FLATtop.....	423
[[:SENSe]:ACPower:OFFSet[1] 2:LIST:BANDwidth:SHAPE?.....	423
[[:SENSe]:ACPower:OFFSet[1] 2:LIST:BANDwidth:TYPE DB3 DB6, DB3 DB6, DB3 DB6, DB3 DB6, DB3 DB6, DB3 DB6.....	424
[[:SENSe]:ACPower:OFFSet[1] 2:LIST:BANDwidth:TYPE?.....	424
[[:SENSe]:ACPower:OFFSet[1] 2:LIST:BANDwidth:VIDeo <freq>, <freq>, <freq>, <freq>, <freq>, <freq>..	422
[[:SENSe]:ACPower:OFFSet[1] 2:LIST:BANDwidth:VIDeo:AUTO OFF ON 0 1, OFF ON 0 1, OFF ON 0 1, OFF ON 0 1, OFF ON 0 1, OFF ON 0 1.....	422

List of Commands

[[:SENSe]:ACPower:OFFSet[1]2:LIST:BANDwidth:VIDeo:AUTO?	422
[[:SENSe]:ACPower:OFFSet[1]2:LIST:BANDwidth:VIDeo?	422
[[:SENSe]:ACPower:OFFSet[1]2:LIST:BANDwidth[:INTegration] <bandwidth>, <bandwidth>, <bandwidth>, <bandwidth>, <bandwidth>, <bandwidth>	418
[[:SENSe]:ACPower:OFFSet[1]2:LIST:BANDwidth[:INTegration]?	418
[[:SENSe]:ACPower:OFFSet[1]2:LIST:FILTer:ALPHa <real>,.....	434
[[:SENSe]:ACPower:OFFSet[1]2:LIST:FILTer:ALPHa?	434
[[:SENSe]:ACPower:OFFSet[1]2:LIST:FILTer[:RRC][:STATe] ON OFF 1 0,....	433
[[:SENSe]:ACPower:OFFSet[1]2:LIST:FILTer[:RRC][:STATe]?	433
[[:SENSe]:ACPower:OFFSet[1]2:LIST:RCARrier <real>, <real>, <real>, <real>, <real>, <real>	427
[[:SENSe]:ACPower:OFFSet[1]2:LIST:RCARrier?	427
[[:SENSe]:ACPower:OFFSet[1]2:LIST:RPSDensity <rel_ampl>, <rel_ampl>, <rel_ampl>, <rel_ampl>, <rel_ampl>, <rel_ampl>.	430
[[:SENSe]:ACPower:OFFSet[1]2:LIST:RPSDensity?	430
[[:SENSe]:ACPower:OFFSet[1]2:LIST:SIDE NEGative BOTH POSitive,NEGative BOTH POSitive,NEGative BOTH POSitive,NEGative BOTH POSitive,NEGative BOTH POSitive,NEGative BOTH POSitive.	432
[[:SENSe]:ACPower:OFFSet[1]2:LIST:SIDE?	432
[[:SENSe]:ACPower:OFFSet[1]2:LIST:STATe OFF ON 0 1, OFF ON 0 1, OFF ON 0 1, OFF ON 0 1, OFF ON 0 1, OFF ON 0 1.	416
[[:SENSe]:ACPower:OFFSet[1]2:LIST:STATe?	416
[[:SENSe]:ACPower:OFFSet[1]2:LIST:TEST ABSolute AND OR RELative, ABSolute AND OR RELative, ABSolute AND OR RELative, ABSolute AND OR RELative, ABSolute AND OR RELative, ABSolute AND OR RELative, ABSolute AND OR RELative	431
[[:SENSe]:ACPower:OFFSet[1]2:LIST:TEST?	431
[[:SENSe]:ACPower:OFFSet[1]2:LIST[:FREQuency] <freq>, <freq>, <freq>, <freq>, <freq>, <freq>	416
[[:SENSe]:ACPower:OFFSet[1]2:LIST[:FREQuency]?	416
[[:SENSe]:ACPower:OFFSet[1]2:TYPE CTOCenter CTOEdge ETOCenter ETOEdge	436
[[:SENSe]:ACPower:OFFSet[1]2:TYPE?	436
[[:SENSe]:ACPower:SWEep:POINts <integer>	463
[[:SENSe]:ACPower:SWEep:POINts?	463
[[:SENSe]:ACPower:SWEep:TIME <time>	460
[[:SENSe]:ACPower:SWEep:TIME:AUTO OFF ON 0 1	460
[[:SENSe]:ACPower:SWEep:TIME:AUTO:RULEs NORMal ACCuracy	462

List of Commands

[:SENSe]:ACPower:SWEEp:TIME:AUTO:RULEs?	462
[:SENSe]:ACPower:SWEEp:TIME:AUTO?	460
[:SENSe]:ACPower:SWEEp:TIME?	460
[:SENSe]:ACPower:TYPE TPRef PSDRef	440
[:SENSe]:ACPower:TYPE?	440
[:SENSe]:ADC:DITHer:AUTO[:STATe] OFF ON 0 1	1109
[:SENSe]:ADC:DITHer:AUTO[:STATe]?	1109
[:SENSe]:ADC:DITHer[:STATe] OFF ON HIGH	1108
[:SENSe]:ADC:DITHer[:STATe]?	1108
[:SENSe]:AVERAge:CLEAr	1098
[:SENSe]:AVERAge:COUNt <integer>	1097
[:SENSe]:AVERAge:COUNt?	1097
[:SENSe]:AVERAge:TYPE RMS LOG SCALAr [:SENSe]:AVERAge:TYPE?	1098
[:SENSe]:AVERAge:TYPE:AUTO OFF ON 0 1	1098
[:SENSe]:AVERAge:TYPE:AUTO?	1098
[:SENSe]:BANDwidth BWIDth:SHAPE GAUSSian FLATtop	952
[:SENSe]:BANDwidth BWIDth:SHAPE?	952
[:SENSe]:BANDwidth BWIDth:TYPE DB3 DB6 IMPulse NOISe	953
[:SENSe]:BANDwidth BWIDth:TYPE?	953
[:SENSe]:BANDwidth BWIDth:VIDeo <freq>	947
[:SENSe]:BANDwidth BWIDth:VIDeo:AUTO OFF ON 0 1	947
[:SENSe]:BANDwidth BWIDth:VIDeo:AUTO?	947
[:SENSe]:BANDwidth BWIDth:VIDeo:RATio <real>	949
[:SENSe]:BANDwidth BWIDth:VIDeo:RATio:AUTO OFF ON 0 1	949
[:SENSe]:BANDwidth BWIDth:VIDeo:RATio:AUTO?	949
[:SENSe]:BANDwidth BWIDth:VIDeo:RATio?	949
[:SENSe]:BANDwidth BWIDth:VIDeo?	947
[:SENSe]:BANDwidth BWIDth[:RESolution] <freq>	945
[:SENSe]:BANDwidth BWIDth[:RESolution]:AUTO OFF ON 0 1	945
[:SENSe]:BANDwidth BWIDth[:RESolution]:AUTO?	945
[:SENSe]:BANDwidth BWIDth[:RESolution]?	945

List of Commands

[[:SENSe]:CHPower:AVERage:COUNT <integer>	323
[[:SENSe]:CHPower:AVERage:COUNT?	323
[[:SENSe]:CHPower:AVERage:TCONtrol EXPonential REPeat	324
[[:SENSe]:CHPower:AVERage:TCONtrol?	324
[[:SENSe]:CHPower:AVERage[:STATe] ON OFF 1 0	323
[[:SENSe]:CHPower:AVERage[:STATe]?	323
[[:SENSe]:CHPower:BANDwidth:INTegration <bandwidth>	325
[[:SENSe]:CHPower:BANDwidth:INTegration?	325
[[:SENSe]:CHPower:BANDwidth:SHAPE GAUSSian FLATtop	309
[[:SENSe]:CHPower:BANDwidth:SHAPE?	309
[[:SENSe]:CHPower:BANDwidth:VIDeo <bandwidth>	307
[[:SENSe]:CHPower:BANDwidth:VIDeo:AUTO ON OFF 1 0	307
[[:SENSe]:CHPower:BANDwidth:VIDeo:AUTO?	307
[[:SENSe]:CHPower:BANDwidth:VIDeo?.	307
[[:SENSe]:CHPower:BANDwidth[:RESolution] <bandwidth>	306
[[:SENSe]:CHPower:BANDwidth[:RESolution]:AUTO ON OFF 1 0	306
[[:SENSe]:CHPower:BANDwidth[:RESolution]:AUTO?	306
[[:SENSe]:CHPower:BANDwidth[:RESolution]?	306
[[:SENSe]:CHPower:DETEctor:AUTO ON OFF 1 0	352
[[:SENSe]:CHPower:DETEctor:AUTO?	352
[[:SENSe]:CHPower:DETEctor[:FUNctIon] NORMal AVERage POSitive SAMPle NEGative	351
[[:SENSe]:CHPower:DETEctor[:FUNctIon]?	351
[[:SENSe]:CHPower:FILTer[:RRC]:ALPHa <real>	330
[[:SENSe]:CHPower:FILTer[:RRC]:ALPHa?	330
[[:SENSe]:CHPower:FILTer[:RRC]:BANDwidth <real>	330
[[:SENSe]:CHPower:FILTer[:RRC]:BANDwidth?.	330
[[:SENSe]:CHPower:FILTer[:RRC][:STATe] OFF ON 0 1	329
[[:SENSe]:CHPower:FILTer[:RRC][:STATe]?	329
[[:SENSe]:CHPower:FREQUency:SPAN <freq>	343
[[:SENSe]:CHPower:FREQUency:SPAN:FULL	344
[[:SENSe]:CHPower:FREQUency:SPAN:PREVIOUS	345

List of Commands

[[:SENSe]:CHPower:FREQuency:SPAN?	343
[[:SENSe]:CHPower:FREQuency:SYNThesis:AUTO[:STATe] OFF ON 0 1	326
[[:SENSe]:CHPower:FREQuency:SYNThesis:AUTO[:STATe]?	326
[[:SENSe]:CHPower:FREQuency:SYNThesis[:STATe] 1 2 3	327
[[:SENSe]:CHPower:FREQuency:SYNThesis[:STATe]?	327
[[:SENSe]:CHPower:IF:GAIN:AUTO[:STATe] ON OFF 1 0	328
[[:SENSe]:CHPower:IF:GAIN:AUTO[:STATe]?	328
[[:SENSe]:CHPower:IF:GAIN[:STATe] ON OFF 1 0	328
[[:SENSe]:CHPower:IF:GAIN[:STATe]?	328
[[:SENSe]:CHPower:SHOUlder:OFFSet:FREQuency <freq>	333
[[:SENSe]:CHPower:SHOUlder:OFFSet:FREQuency:STARt <freq>	332
[[:SENSe]:CHPower:SHOUlder:OFFSet:FREQuency:STARt?	332
[[:SENSe]:CHPower:SHOUlder:OFFSet:FREQuency:STOP <freq>	333
[[:SENSe]:CHPower:SHOUlder:OFFSet:FREQuency:STOP?	333
[[:SENSe]:CHPower:SHOUlder:OFFSet:FREQuency?	333
[[:SENSe]:CHPower:SWEEp:POINts <integer>	349
[[:SENSe]:CHPower:SWEEp:POINts?	349
[[:SENSe]:CHPower:SWEEp:TIME <time>	346
[[:SENSe]:CHPower:SWEEp:TIME:AUTO OFF ON 0 1	346
[[:SENSe]:CHPower:SWEEp:TIME:AUTO:RULEs NORMAl ACCuracy	348
[[:SENSe]:CHPower:SWEEp:TIME:AUTO:RULEs?	348
[[:SENSe]:CHPower:SWEEp:TIME:AUTO?	346
[[:SENSe]:CHPower:SWEEp:TIME?	346
[[:SENSe]:CORRection:BTS[:RF]:GAIN <rel_amp>	1003
[[:SENSe]:CORRection:BTS[:RF]:GAIN?	1003
[[:SENSe]:CORRection:CSET:ALL:DELeTe	1020
[[:SENSe]:CORRection:CSET:ALL[:STATe] ON OFF 1 0	1020
[[:SENSe]:CORRection:CSET:ALL[:STATe]?	1020
[[:SENSe]:CORRection:CSET[1] 2 3 4:ANTenna[:UNIT] GAUSs PTESla UVM UAM NOConversion	1013
[[:SENSe]:CORRection:CSET[1] 2 3 4:ANTenna[:UNIT]?	1013
[[:SENSe]:CORRection:CSET[1] 2 3 4 5 6:COMMeNt "text"	1017

List of Commands

[[:SENSe]:CORRection:CSET[1] 2 3 4 5 6:COMMeNt?	1017
[[:SENSe]:CORRection:CSET[1] 2 3 4 5 6:DATA <freq>, <ampl>,	1020
[[:SENSe]:CORRection:CSET[1] 2 3 4 5 6:DATA:MERGe <freq>, <ampl>,	1021
[[:SENSe]:CORRection:CSET[1] 2 3 4 5 6:DATA?	1020
[[:SENSe]:CORRection:CSET[1] 2 3 4 5 6:DELeTe	1019
[[:SENSe]:CORRection:CSET[1] 2 3 4 5 6:DESCRiption "text"	1016
[[:SENSe]:CORRection:CSET[1] 2 3 4 5 6:DESCRiption?	1016
[[:SENSe]:CORRection:CSET[1] 2 3 4 5 6:X:SPACing LINear LOGarithmic.	1015
[[:SENSe]:CORRection:CSET[1] 2 3 4 5 6:X:SPACing?	1015
[[:SENSe]:CORRection:CSET[1] 2 3 4 5 6[:STATe] ON OFF 1 0	1012
[[:SENSe]:CORRection:CSET[1] 2 3 4 5 6[:STATe]?	1012
[[:SENSe]:CORRection:IMPedance[:INPut][:MAGNitude] 50 75.	970
[[:SENSe]:CORRection:IMPedance[:INPut][:MAGNitude]?	970
[[:SENSe]:CORRection:IQ:I:GAIN <rel_ampl>	1004
[[:SENSe]:CORRection:IQ:I:GAIN?	1004
[[:SENSe]:CORRection:IQ:I:Q:ATTenuation <rel_ampl>	983
[[:SENSe]:CORRection:IQ:I:Q:ATTenuation:RATio <real>	983
[[:SENSe]:CORRection:IQ:I:Q:ATTenuation:RATio?	983
[[:SENSe]:CORRection:IQ:I:Q:ATTenuation?	983
[[:SENSe]:CORRection:IQ:Q:GAIN <rel_ampl>.	1005
[[:SENSe]:CORRection:IQ:Q:GAIN?	1005
[[:SENSe]:CORRection:IQ:Q:SKEW <seconds>	982
[[:SENSe]:CORRection:IQ:Q:SKEW?	982
[[:SENSe]:CORRection:IQ[:I]:SKEW <seconds>	978
[[:SENSe]:CORRection:IQ[:I]:SKEW?	978
[[:SENSe]:CORRection:MS[:RF]:GAIN <rel_ampl>.	1002
[[:SENSe]:CORRection:MS[:RF]:GAIN?	1002
[[:SENSe]:CORRection:NOISe:FLOOr ON OFF 1 0	1143
[[:SENSe]:CORRection:NOISe:FLOOr?	1143
[[:SENSe]:CORRection:SA[:RF]:GAIN <rel_ampl>.	1002
[[:SENSe]:CORRection:SA[:RF]:GAIN?	1002

List of Commands

[:SENSe]:DEMod AM FM PM OFF	1114
[:SENSe]:DEMod:AM:BANDwidth:CHANnel <freq>	1115
[:SENSe]:DEMod:AM:BANDwidth:CHANnel?	1115
[:SENSe]:DEMod:FM:BANDwidth:CHANnel <freq>.	1116
[:SENSe]:DEMod:FM:BANDwidth:CHANnel?.	1116
[:SENSe]:DEMod:FM:DEEMphasis OFF US25 US50 US75 US750.	1116
[:SENSe]:DEMod:FM:DEEMphasis?	1116
[:SENSe]:DEMod:PM:BANDwidth:CHANnel <freq>.	1118
[:SENSe]:DEMod:PM:BANDwidth:CHANnel?.	1118
[:SENSe]:DEMod:STATe OFF ON 0 1	1119
[:SENSe]:DEMod:STATe?.	1119
[:SENSe]:DEMod:TIME <time>.	1119
[:SENSe]:DEMod:TIME?	1119
[:SENSe]:DEMod?.	1114
[:SENSe]:DETEctor:AUTO ON OFF 1 0.	1224
[:SENSe]:DETEctor:AUTO?	1224
[:SENSe]:DETEctor:TRACe[1] 2 3 4 5 6 AVERAge NEGative NORMal POSitive SAMPlE QPEak EAVERage RAV- erage	1220
[:SENSe]:DETEctor:TRACe[1] 2 3 4 5 6:AUTO ON OFF 1 0.	1223
[:SENSe]:DETEctor:TRACe[1] 2 3 4 5 6:AUTO?	1223
[:SENSe]:DETEctor:TRACe[1] 2 3 4 5 6?	1220
[:SENSe]:DETEctor[:FUNction] NORMal AVERAge POSitive SAMPlE NEGative QPEak EAVERage EPOSi- tive MPOSitive RMS	1221
[:SENSe]:DETEctor[:FUNction]?	1221
[:SENSe]:EVM:AVERAge:COUNt <integer>	667
[:SENSe]:EVM:AVERAge:COUNt?	667
[:SENSe]:EVM:AVERAge:TCONtrol EXPonential REPeat	668
[:SENSe]:EVM:AVERAge:TCONtrol?	668
[:SENSe]:EVM:AVERAge[:STATe] OFF ON 0 1	667
[:SENSe]:EVM:AVERAge[:STATe]?	667
[:SENSe]:EVM:CLKRate <freq>	673
[:SENSe]:EVM:CLKRate:AUTO ON OFF 1 0	673

List of Commands

[[:SENSe]:EVM:CLKRate:AUTO?	673
[[:SENSe]:EVM:CLKRate?	673
[[:SENSe]:EVM:DSYMBOLS <integer>	674
[[:SENSe]:EVM:DSYMBOLS?	674
[[:SENSe]:EVM:EQualization:STATe OFF ON 0 1	675
[[:SENSe]:EVM:EQualization:STATe?	675
[[:SENSe]:EVM:FFTStart CP08 CP18 CP28 CP38 CP48 CP58 CP68 CP78 CP88	677
[[:SENSe]:EVM:FFTStart?	677
[[:SENSe]:EVM:MERLimit <rel_amp>	672
[[:SENSe]:EVM:MERLimit:AUTO ON OFF 1 0	672
[[:SENSe]:EVM:MERLimit:AUTO?	672
[[:SENSe]:EVM:MERLimit?	672
[[:SENSe]:EVM:OBFiltering OFF ON 0 1	676
[[:SENSe]:EVM:OBFiltering?	676
[[:SENSe]:EVM:PLCH:SLCH[:INDEX] <integer>	670
[[:SENSe]:EVM:PLCH:SLCH[:INDEX]?	670
[[:SENSe]:EVM:PLCH:TYPE SLCH CLCH	670
[[:SENSe]:EVM:PLCH:TYPE?	670
[[:SENSe]:EVM:SFRame[:IMMediate]	676
[[:SENSe]:EVM:SPECTrum NORMal INVert	673
[[:SENSe]:EVM:SPECTrum?	673
[[:SENSe]:EVM:TS:MINTerval <integer>	671
[[:SENSe]:EVM:TS:MINTerval?	671
[[:SENSe]:EVM:TS:MODulation BPSK QPSK QAM16	672
[[:SENSe]:EVM:TS:MODulation?	672
[[:SENSe]:EVM:TS:STARt <integer>	671
[[:SENSe]:EVM:TS:STARt?	671
[[:SENSe]:EVM:TYPE PLCH TS FRAME	669
[[:SENSe]:EVM:TYPE?	669
[[:SENSe]:FEED RF AIQ IQ IONLy QONLy INdependent AREFERENCE	969
[[:SENSe]:FEED:AREFERENCE REF50 REF4800 OFF	999

List of Commands

[[:SENSe]:FEED:AREFERENCE?	999
[[:SENSe]:FEED:DATA INPut STORed RECORded	1006
[[:SENSe]:FEED:DATA:STORE	1008
[[:SENSe]:FEED:DATA?	1006
[[:SENSe]:FEED:IQ:TYPE IQ IONLy QONLy INDEpendent	974
[[:SENSe]:FEED:IQ:TYPE?	974
[[:SENSe]:FEED?	969
[[:SENSe]:FREQuency:CENTer <freq>	960
[[:SENSe]:FREQuency:CENTer:STEP:AUTO ON OFF 1 0	963
[[:SENSe]:FREQuency:CENTer:STEP:AUTO?	963
[[:SENSe]:FREQuency:CENTer:STEP[:INCRement] <freq>	963
[[:SENSe]:FREQuency:CENTer:STEP[:INCRement]?	963
[[:SENSe]:FREQuency:CENTer?	960
[[:SENSe]:FREQuency:CHANnel:NUMBer <integer>	959
[[:SENSe]:FREQuency:CHANnel:NUMBer?	959
[[:SENSe]:FREQuency:CHANnel:STEP <integer>	962
[[:SENSe]:FREQuency:CHANnel:STEP?	962
[[:SENSe]:FREQuency:CHANnel:TABLE:BNTSc[:SElect] VHF UHF	965
[[:SENSe]:FREQuency:CHANnel:TABLE:BNTSc[:SElect]?	965
[[:SENSe]:FREQuency:CHANnel:TABLE:BPAL[:SElect] VHF UHF HRC S SCBL CEN	966
[[:SENSe]:FREQuency:CHANnel:TABLE:BPAL[:SElect]?	966
[[:SENSe]:FREQuency:CHANnel:TABLE:DPAL[:SElect] DS Z	966
[[:SENSe]:FREQuency:CHANnel:TABLE:DPAL[:SElect]?	966
[[:SENSe]:FREQuency:CHANnel:TABLE:IPAL[:SElect] VHF UHF HRC	966
[[:SENSe]:FREQuency:CHANnel:TABLE:IPAL[:SElect]?	966
[[:SENSe]:FREQuency:CHANnel:TABLE:JNTSc[:SElect] CBL AIR	964
[[:SENSe]:FREQuency:CHANnel:TABLE:JNTSc[:SElect]?	964
[[:SENSe]:FREQuency:CHANnel:TABLE:MNTSc[:SElect] STD AIR HRC IRC	964
[[:SENSe]:FREQuency:CHANnel:TABLE:MNTSc[:SElect]?	964
[[:SENSe]:FREQuency:CHANnel:TABLE:MPAL[:SElect] STD AIR HRC IRC	965
[[:SENSe]:FREQuency:CHANnel:TABLE:MPAL[:SElect]?	965

List of Commands

[[:SENSe]:FREQuency:CHANnel:TABLE[:SElect] MNTSc JNTSc BNTSc MPAL IPAL BPAL DPAL	963
[[:SENSe]:FREQuency:CHANnel:TABLE[:SElect]?	963
[[:SENSe]:FREQuency:IQ:CENTer <freq>	962
[[:SENSe]:FREQuency:IQ:CENTer?	962
[[:SENSe]:FREQuency:RF:CENTer <freq>	961
[[:SENSe]:FREQuency:RF:CENTer?	961
[[:SENSe]:FREQuency:SPAN <freq>	1173
[[:SENSe]:FREQuency:SPAN:BANDwidth[:RESolution]:RATio <integer>	950
[[:SENSe]:FREQuency:SPAN:BANDwidth[:RESolution]:RATio:AUTO OFF ON 0 1	950
[[:SENSe]:FREQuency:SPAN:BANDwidth[:RESolution]:RATio:AUTO?	950
[[:SENSe]:FREQuency:SPAN:BANDwidth[:RESolution]:RATio?	950
[[:SENSe]:FREQuency:SPAN:FULL	1175
[[:SENSe]:FREQuency:SPAN:PREVious	1177
[[:SENSe]:FREQuency:SPAN?	1173
[[:SENSe]:FREQuency:SYNThesis:AUTO[:STATe] OFF ON 0 1	1106
[[:SENSe]:FREQuency:SYNThesis:AUTO[:STATe]?	1106
[[:SENSe]:FREQuency:SYNThesis[:STATe] 1 2 3	1105
[[:SENSe]:FREQuency:SYNThesis[:STATe]?	1105
[[:SENSe]:IF:GAIN:FFT:AUTO[:STATe] OFF ON 0 1	1113
[[:SENSe]:IF:GAIN:FFT:AUTO[:STATe]?	1113
[[:SENSe]:IF:GAIN:FFT[:STATe] AUTOOrange LOW HIGH	1112
[[:SENSe]:IF:GAIN:FFT[:STATe]?	1112
[[:SENSe]:IF:GAIN:SWEpt:AUTO[:STATe] OFF ON 0 1	1111
[[:SENSe]:IF:GAIN:SWEpt:AUTO[:STATe]?	1111
[[:SENSe]:IF:GAIN:SWEpt[:STATe] OFF ON 0 1	1110
[[:SENSe]:IF:GAIN:SWEpt[:STATe]?	1110
[[:SENSe]:MONitor:AVERAge:COUNT <integer>	816
[[:SENSe]:MONitor:AVERAge:COUNT?	816
[[:SENSe]:MONitor:AVERAge:TCONtrol EXPonential REPeat	817
[[:SENSe]:MONitor:AVERAge:TCONtrol?	817
[[:SENSe]:MONitor:AVERAge[:STATe] OFF ON 0 1	816

List of Commands

[:SENSe]:MONitor:AVERage[:STATe]?	816
[:SENSe]:MONitor:BANDwidth:VIDeo <bandwidth>	799
[:SENSe]:MONitor:BANDwidth:VIDeo:AUTO ON OFF 1 0	799
[:SENSe]:MONitor:BANDwidth:VIDeo:AUTO?	799
[:SENSe]:MONitor:BANDwidth:VIDeo:RATio <real>	
[:SENSe]:MONitor:BANDwidth:VIDeo:RATio?	801
[:SENSe]:MONitor:BANDwidth:VIDeo:RATio:AUTO OFF ON 0 1	801
[:SENSe]:MONitor:BANDwidth:VIDeo:RATio:AUTO?	801
[:SENSe]:MONitor:BANDwidth:VIDeo?	799
[:SENSe]:MONitor:BANDwidth[:RESolution] <freq>	797
[:SENSe]:MONitor:BANDwidth[:RESolution]:AUTO OFF ON 0 1	797
[:SENSe]:MONitor:BANDwidth[:RESolution]:AUTO?	797
[:SENSe]:MONitor:BANDwidth[:RESolution]?	797
[:SENSe]:MONitor:DETEctor:AUTO ON OFF 1 0	834
[:SENSe]:MONitor:DETEctor:AUTO?	834
[:SENSe]:MONitor:DETEctor:TRACe AVERAge NEGative NORMal POSitive SAMPle	833
[:SENSe]:MONitor:DETEctor:TRACe?	833
[:SENSe]:MONitor:FREQUency:SPAN <freq>	826
[:SENSe]:MONitor:FREQUency:SPAN:BANDwidth[:RESolution] :RATio <integer>	802
[:SENSe]:MONitor:FREQUency:SPAN:BANDwidth[:RESolution] :RATio:AUTO OFF ON 0 1	802
[:SENSe]:MONitor:FREQUency:SPAN:BANDwidth[:RESolution] :RATio:AUTO?	802
[:SENSe]:MONitor:FREQUency:SPAN:BANDwidth[:RESolution] :RATio?	802
[:SENSe]:MONitor:FREQUency:SPAN:FULL	827
[:SENSe]:MONitor:FREQUency:SPAN:PREVIOUS	827
[:SENSe]:MONitor:FREQUency:SPAN?	826
[:SENSe]:MONitor:SWEep:POINts <integer>	830
[:SENSe]:MONitor:SWEep:POINts?	830
[:SENSe]:MONitor:SWEep:TIME <time>	829
[:SENSe]:MONitor:SWEep:TIME:AUTO OFF ON 0 1	829
[:SENSe]:MONitor:SWEep:TIME:AUTO?	829
[:SENSe]:MONitor:SWEep:TIME?	829

List of Commands

[[:SENSe]:OBWidth:AVERage:COUNT <integer>	758
[[:SENSe]:OBWidth:AVERage:COUNT?	758
[[:SENSe]:OBWidth:AVERage:TCONtrol EXPonential REPeat	759
[[:SENSe]:OBWidth:AVERage:TCONtrol?	759
[[:SENSe]:OBWidth:AVERage[:STATe] ON OFF 1 0	758
[[:SENSe]:OBWidth:AVERage[:STATe]?	758
[[:SENSe]:OBWidth:BANDwidth:SHAPE GAUSSian FLATtop	746
[[:SENSe]:OBWidth:BANDwidth:SHAPE?	746
[[:SENSe]:OBWidth:BANDwidth:VIDeo <bandwidth>	744
[[:SENSe]:OBWidth:BANDwidth:VIDeo:AUTO ON OFF 1 0	744
[[:SENSe]:OBWidth:BANDwidth:VIDeo:AUTO?	744
[[:SENSe]:OBWidth:BANDwidth:VIDeo?	744
[[:SENSe]:OBWidth:BANDwidth[:RESolution] <bandwidth>	743
[[:SENSe]:OBWidth:BANDwidth[:RESolution]:AUTO ON OFF 1 0	743
[[:SENSe]:OBWidth:BANDwidth[:RESolution]:AUTO?	743
[[:SENSe]:OBWidth:BANDwidth[:RESolution]?	743
[[:SENSe]:OBWidth:DETeCTOR:AUTO ON OFF 1 0	783
[[:SENSe]:OBWidth:DETeCTOR:AUTO?	783
[[:SENSe]:OBWidth:DETeCTOR[:FUNction] NORMal AVERage POSitive SAMPle NEGative	782
[[:SENSe]:OBWidth:DETeCTOR[:FUNction]?	782
[[:SENSe]:OBWidth:FREQuency:SPAN <freq>	774
[[:SENSe]:OBWidth:FREQuency:SPAN:FULL	775
[[:SENSe]:OBWidth:FREQuency:SPAN:PREVious	775
[[:SENSe]:OBWidth:FREQuency:SPAN?	774
[[:SENSe]:OBWidth:IF:GAIN:AUTO[:STATe] ON OFF 1 0	762
[[:SENSe]:OBWidth:IF:GAIN:AUTO[:STATe]?	762
[[:SENSe]:OBWidth:IF:GAIN[:STATe] ON OFF 1 0	763
[[:SENSe]:OBWidth:IF:GAIN[:STATe]?	763
[[:SENSe]:OBWidth:MAXHold ON OFF 1 0	760
[[:SENSe]:OBWidth:MAXHold?	760
[[:SENSe]:OBWidth:PERCent <real>	760

List of Commands

[[:SENSe]:OBWidth:PERCent?	760
[[:SENSe]:OBWidth:SWEEp:POINts <integer>.....	779
[[:SENSe]:OBWidth:SWEEp:POINts?	779
[[:SENSe]:OBWidth:SWEEp:TIME <time>	777
[[:SENSe]:OBWidth:SWEEp:TIME:AUTO OFF ON 0 1.....	777
[[:SENSe]:OBWidth:SWEEp:TIME:AUTO:RULEs NORMAl ACCuracy	778
[[:SENSe]:OBWidth:SWEEp:TIME:AUTO:RULEs?	778
[[:SENSe]:OBWidth:SWEEp:TIME:AUTO?	777
[[:SENSe]:OBWidth:SWEEp:TIME?	777
[[:SENSe]:OBWidth:XDB <rel_ampl>.....	761
[[:SENSe]:OBWidth:XDB?	761
[[:SENSe]:POWer:IQ:Q:RANGe[:UPPer] <ampl>	923
[[:SENSe]:POWer:IQ:Q:RANGe[:UPPer]?	923
[[:SENSe]:POWer:IQ:RANGe:AUTO OFF ON 0 1	921
[[:SENSe]:POWer:IQ:RANGe:AUTO?	921
[[:SENSe]:POWer:IQ[:I]:RANGe[:UPPer] <ampl>	921
[[:SENSe]:POWer:IQ[:I]:RANGe[:UPPer]?	921
[[:SENSe]:POWer[:RF]:ATTenuation <rel_ampl>	912
[[:SENSe]:POWer[:RF]:ATTenuation:AUTO OFF ON 0 1	912
[[:SENSe]:POWer[:RF]:ATTenuation:AUTO?	912
[[:SENSe]:POWer[:RF]:ATTenuation:STEP[:INCRement] 10 dB 2 dB	918
[[:SENSe]:POWer[:RF]:ATTenuation:STEP[:INCRement]?	918
[[:SENSe]:POWer[:RF]:ATTenuation?	912
[[:SENSe]:POWer[:RF]:EATTenuation <rel_ampl>.....	916
[[:SENSe]:POWer[:RF]:EATTenuation:STATe OFF ON 0 1	914
[[:SENSe]:POWer[:RF]:EATTenuation:STATe?	914
[[:SENSe]:POWer[:RF]:EATTenuation?	916
[[:SENSe]:POWer[:RF]:GAIN:BAND LOW FULL	940
[[:SENSe]:POWer[:RF]:GAIN:BAND?	940
[[:SENSe]:POWer[:RF]:GAIN[:STATe] OFF ON 0 1.....	940
[[:SENSe]:POWer[:RF]:GAIN[:STATe]?	940

List of Commands

[[:SENSe]:POWer[:RF]:MIXer:RANGe[:UPPer] <real>	919
[[:SENSe]:POWer[:RF]:MIXer:RANGe[:UPPer]?	919
[[:SENSe]:POWer[:RF]:MW:PATH STD LNPath MPBypass FULL	936
[[:SENSe]:POWer[:RF]:MW:PATH?	936
[[:SENSe]:POWer[:RF]:PADJust <freq>	927
[[:SENSe]:POWer[:RF]:PADJust:PRESelector MWAVe MMWave EXTErnal	928
[[:SENSe]:POWer[:RF]:PADJust:PRESelector?	928
[[:SENSe]:POWer[:RF]:PADJust?	927
[[:SENSe]:POWer[:RF]:PCENter	926
[[:SENSe]:POWer[:RF]:RANGe:AUTO ON OFF 1 0	918
[[:SENSe]:POWer[:RF]:RANGe:AUTO?	918
[[:SENSe]:POWer[:RF]:RANGe:OPTimize IMMEDIATE	917
[[:SENSe]:POWer[:RF]:RANGe:OPTimize:ATTenuation OFF ELECTrical COMBined	917
[[:SENSe]:POWer[:RF]:RANGe:OPTimize:ATTenuation?	917
[[:SENSe]:PStatistic:SLTView[:STATe]?	521
[[:SENSe]:PStatistic:BANDwidth <freq>	486
[[:SENSe]:PStatistic:BANDwidth?	486
[[:SENSe]:PStatistic:COUNts <integer>	499
[[:SENSe]:PStatistic:COUNts?	499
[[:SENSe]:PStatistic:IF:GAIN:AUTO[:STATe] ON OFF 1 0	503
[[:SENSe]:PStatistic:IF:GAIN:AUTO[:STATe]?	503
[[:SENSe]:PStatistic:IF:GAIN[:STATe] ON OFF 1 0	503
[[:SENSe]:PStatistic:IF:GAIN[:STATe]?	503
[[:SENSe]:PStatistic:SLTView[:STATe] OFF ON 0 1	521
[[:SENSe]:PStatistic:SWEep:CYCLes <integer>	500
[[:SENSe]:PStatistic:SWEep:CYCLes?	500
[[:SENSe]:PStatistic:SWEep:OFFSet <time>	502
[[:SENSe]:PStatistic:SWEep:OFFSet?	502
[[:SENSe]:PStatistic:SWEep:TIME <time>	500
[[:SENSe]:PStatistic:SWEep:TIME <time>	501
[[:SENSe]:PStatistic:SWEep:TIME?	500

List of Commands

[:SENSe]:PSTatistic:SWEEP:TIME?	501
[:SENSe]:RADio:STANdard:DEVIce TRANsmitter EXCiter	1141
[:SENSe]:RADio:STANdard:DEVIce?	1141
[:SENSe]:RECOrding:ABORt	1009
[:SENSe]:RECOrding:INITiate[:IMMediate].	1009
[:SENSe]:RECOrding:LENGth <real>,SECOnds RECOrds POINts	1009
[:SENSe]:RECOrding:LENGth:STATe MAX MANual	1009
[:SENSe]:RECOrding:LENGth:STATe?	1009
[:SENSe]:RECOrding:LENGth:UNIT?	1010
[:SENSe]:RECOrding:LENGth:VALue?	1010
[:SENSe]:ROSCillator:BANDwidth WIDE NARRow	1025
[:SENSe]:ROSCillator:BANDwidth?	1025
[:SENSe]:ROSCillator:COUPling NORMal NACQuisition	1026
[:SENSe]:ROSCillator:COUPling?	1026
[:SENSe]:ROSCillator:EXTErnal:FREQuency <freq>	1024
[:SENSe]:ROSCillator:EXTErnal:FREQuency?	1024
[:SENSe]:ROSCillator:SOURce INTernAl EXTErnAl	1023
[:SENSe]:ROSCillator:SOURce:TYPE INTernAl EXTErnAl SENSe	1022
[:SENSe]:ROSCillator:SOURce:TYPE?	1022
[:SENSe]:ROSCillator:SOURce?	1022
[:SENSe]:SEMAsk:AVERAge:COUNt <integer>	551
[:SENSe]:SEMAsk:AVERAge:COUNt?	551
[:SENSe]:SEMAsk:AVERAge[:STATe] ON OFF 1 0	551
[:SENSe]:SEMAsk:AVERAge[:STATe]?	551
[:SENSe]:SEMAsk:BANDwidth:SHAPE ASENse GAUSSian FLATtop	540
[:SENSe]:SEMAsk:BANDwidth:SHAPE?	540
[:SENSe]:SEMAsk:BANDwidth[1] 2:INTegration <bandwidth>	553
[:SENSe]:SEMAsk:BANDwidth[1] 2:INTegration?	553
[:SENSe]:SEMAsk:BANDwidth[1] 2:VIDeo <bandwidth>	557
[:SENSe]:SEMAsk:BANDwidth[1] 2:VIDeo:AUTO OFF ON 1 0	557
[:SENSe]:SEMAsk:BANDwidth[1] 2:VIDeo:AUTO?	557

List of Commands

[[:SENSe]:SEMAsk:BANDwidth[1]2:VIDeo:RATio <real>	558
[[:SENSe]:SEMAsk:BANDwidth[1]2:VIDeo:RATio:AUTO OFF ON 1 0.	558
[[:SENSe]:SEMAsk:BANDwidth[1]2:VIDeo:RATio:AUTO?	558
[[:SENSe]:SEMAsk:BANDwidth[1]2:VIDeo:RATio	558
[[:SENSe]:SEMAsk:BANDwidth[1]2:VIDeo?	557
[[:SENSe]:SEMAsk:BANDwidth[1]2[:RESolution] <bandwidth>	556
[[:SENSe]:SEMAsk:BANDwidth[1]2[:RESolution]:AUTO OFF ON 1 0	556
[[:SENSe]:SEMAsk:BANDwidth[1]2[:RESolution]:AUTO?	556
[[:SENSe]:SEMAsk:BANDwidth[1]2[:RESolution]?	556
[[:SENSe]:SEMAsk:CARRier:AUTO[:STATe] OFF ON 1 0.	560
[[:SENSe]:SEMAsk:CARRier:AUTO[:STATe]?	560
[[:SENSe]:SEMAsk:CARRier:CPSD <real>	561
[[:SENSe]:SEMAsk:CARRier:CPSD?	561
[[:SENSe]:SEMAsk:CARRier:PEAK[:POWer] <real>	561
[[:SENSe]:SEMAsk:CARRier:PEAK[:POWer]?	561
[[:SENSe]:SEMAsk:CARRier[:POWer] <real>	560
[[:SENSe]:SEMAsk:CARRier[:POWer]?	560
[[:SENSe]:SEMAsk:DETEctor:CARRier:AUTO ON OFF 1 0.	608
[[:SENSe]:SEMAsk:DETEctor:CARRier:AUTO?	608
[[:SENSe]:SEMAsk:DETEctor:CARRier[:FUNctioN] AVERAge NEGAtive NORMAl POSitive SAMPlE	607
[[:SENSe]:SEMAsk:DETEctor:CARRier[:FUNctioN]?	607
[[:SENSe]:SEMAsk:DETEctor:OFFSet:AUTO ON OFF 1 0.	610
[[:SENSe]:SEMAsk:DETEctor:OFFSet:AUTO?	610
[[:SENSe]:SEMAsk:DETEctor:OFFSet[:FUNctioN] AVERAge NEGAtive NORMAl POSitive SAMPlE	609
[[:SENSe]:SEMAsk:DETEctor:OFFSet[:FUNctioN]?	609
[[:SENSe]:SEMAsk:FILTer[:RRC]:ALPHa <real>	584
[[:SENSe]:SEMAsk:FILTer[:RRC]:ALPHa?	584
[[:SENSe]:SEMAsk:FILTer[:RRC][:STATe] OFF ON 0 1	583
[[:SENSe]:SEMAsk:FILTer[:RRC][:STATe]?	583
[[:SENSe]:SEMAsk:FREQuency[1]2:SPAN <freq>.	554
[[:SENSe]:SEMAsk:FREQuency[1]2:SPAN?	554

List of Commands

[[:SENSe]:SEMAsk:LIMits:STD]MAN	585
[[:SENSe]:SEMAsk:LIMits:TYPE MANual JEITa ANONcritical ASUBcritical ACritical TSB.	589
[[:SENSe]:SEMAsk:LIMits:TYPE MANual NONCritical CRITical	586
[[:SENSe]:SEMAsk:LIMits:TYPE:JEITA ASENse J30Mask J40Mask J50Mask	592
[[:SENSe]:SEMAsk:LIMits:TYPE:JEITA?	592
[[:SENSe]:SEMAsk:LIMits:TYPE?.	586
[[:SENSe]:SEMAsk:LIMits:TYPE?	589
[[:SENSe]:SEMAsk:LIMits?	585
[[:SENSe]:SEMAsk:OFFSet[1] 2:LIST:BANDwidth:IMULti <integer>,<integer>,<integer>,<integer>,<integer>,<integer>	571
[[:SENSe]:SEMAsk:OFFSet[1] 2:LIST:BANDwidth:IMULti?	571
[[:SENSe]:SEMAsk:OFFSet[1] 2:LIST:BANDwidth:VIDeo <freq>,<freq>,<freq>,<freq>,<freq>,<freq>	572
[[:SENSe]:SEMAsk:OFFSet[1] 2:LIST:BANDwidth:VIDeo:AUTO OFF ON 0 1,OFF ON 0 1,OFF ON 0 1,OFF ON 0 1,OFF ON 0 1,OFF ON 0 1	572
[[:SENSe]:SEMAsk:OFFSet[1] 2:LIST:BANDwidth:VIDeo:AUTO?	572
[[:SENSe]:SEMAsk:OFFSet[1] 2:LIST:BANDwidth:VIDeo:RATio <real>,<real>,<real>,<real>,<real>,<real>	573
[[:SENSe]:SEMAsk:OFFSet[1] 2:LIST:BANDwidth:VIDeo:RATio:AUTO OFF ON 0 1,OFF ON 0 1,OFF ON 0 1,OFF ON 0 1,OFF ON 0 1,OFF ON 0 1	573
[[:SENSe]:SEMAsk:OFFSet[1] 2:LIST:BANDwidth:VIDeo:RATio:AUTO?	573
[[:SENSe]:SEMAsk:OFFSet[1] 2:LIST:BANDwidth:VIDeo:RATio?	573
[[:SENSe]:SEMAsk:OFFSet[1] 2:LIST:BANDwidth:VIDeo?	572
[[:SENSe]:SEMAsk:OFFSet[1] 2:LIST:BANDwidth[:RESolution] <bandwidth>,<bandwidth>,<bandwidth>,<bandwidth>,<bandwidth>,<bandwidth>	569
[[:SENSe]:SEMAsk:OFFSet[1] 2:LIST:BANDwidth[:RESolution]:AUTO OFF ON 1 0,OFF ON 1 0,OFF ON 1 0,OFF ON 1 0,OFF ON 1 0,OFF ON 1 0	569
[[:SENSe]:SEMAsk:OFFSet[1] 2:LIST:BANDwidth[:RESolution]:AUTO?	569
[[:SENSe]:SEMAsk:OFFSet[1] 2:LIST:BANDwidth[:RESolution]?	569
[[:SENSe]:SEMAsk:OFFSet[1] 2:LIST:FREQuency:STARt <freq>,<freq>,<freq>,<freq>,<freq>,<freq>	563
[[:SENSe]:SEMAsk:OFFSet[1] 2:LIST:FREQuency:STARt?.	563
[[:SENSe]:SEMAsk:OFFSet[1] 2:LIST:FREQuency:STOP <freq>,<freq>,<freq>,<freq>,<freq>,<freq>	565
[[:SENSe]:SEMAsk:OFFSet[1] 2:LIST:FREQuency:STOP?	565
[[:SENSe]:SEMAsk:OFFSet[1] 2:LIST:SIDE BOTH NEGative POSitive,BOTH NEGative POSitive,BOTH NEGative POSitive,BOTH NEGative POSitive,BOTH NEGative POSitive,BOTH NEGative POSitive	568

List of Commands

[::SENSe]:SEMAsk:OFFSet[1]2:LIST:SIDE?	568
[::SENSe]:SEMAsk:OFFSet[1]2:LIST:START:ABSolute <real>,<real>,<real>,<real>,<real>,<real>	574
[::SENSe]:SEMAsk:OFFSet[1]2:LIST:START:ABSolute?	574
[::SENSe]:SEMAsk:OFFSet[1]2:LIST:START:RCARrier <rel_ampl>,<rel_ampl>,<rel_ampl>,<rel_ampl>,<rel_ampl>,<rel_ampl>	578
[::SENSe]:SEMAsk:OFFSet[1]2:LIST:START:RCARrier?	578
[::SENSe]:SEMAsk:OFFSet[1]2:LIST:STATe ON OFF 1 0,ON OFF 1 0,ON OFF 1 0,ON OFF 1 0,ON OFF 1 0,ON OFF 1 0	563
[::SENSe]:SEMAsk:OFFSet[1]2:LIST:STATe?	563
[::SENSe]:SEMAsk:OFFSet[1]2:LIST:STOP:ABSolute <real>,<real>,<real>,<real>,<real>,<real>	576
[::SENSe]:SEMAsk:OFFSet[1]2:LIST:STOP:ABSolute:COUple ON OFF 1 0,ON OFF 1 0,ON OFF 1 0,ON OFF 1 0,ON OFF 1 0,ON OFF 1 0	576
[::SENSe]:SEMAsk:OFFSet[1]2:LIST:STOP:ABSolute:COUple?	576
[::SENSe]:SEMAsk:OFFSet[1]2:LIST:STOP:ABSolute?	576
[::SENSe]:SEMAsk:OFFSet[1]2:LIST:STOP:RCARrier <rel_ampl>,<rel_ampl>,<rel_ampl>,<rel_ampl>,<rel_ampl>,<rel_ampl>	580
[::SENSe]:SEMAsk:OFFSet[1]2:LIST:STOP:RCARrier:COUple ON OFF 1 0,ON OFF 1 0,ON OFF 1 0,ON OFF 1 0,ON OFF 1 0,ON OFF 1 0	580
[::SENSe]:SEMAsk:OFFSet[1]2:LIST:STOP:RCARrier:COUple?	580
[::SENSe]:SEMAsk:OFFSet[1]2:LIST:STOP:RCARrier?	580
[::SENSe]:SEMAsk:OFFSet[1]2:LIST:SWEep:TIME <time>,<time>,<time>,<time>,<time>,<time>	567
[::SENSe]:SEMAsk:OFFSet[1]2:LIST:SWEep:TIME:AUTO ON OFF 1 0,ON OFF 1 0,ON OFF 1 0,ON OFF 1 0,ON OFF 1 0,ON OFF 1 0	567
[::SENSe]:SEMAsk:OFFSet[1]2:LIST:SWEep:TIME:AUTO?	567
[::SENSe]:SEMAsk:OFFSet[1]2:LIST:SWEep:TIME?	567
[::SENSe]:SEMAsk:OFFSet[1]2:LIST:TEST ABSolute AND OR RELative,ABSolute AND OR RELative,ABSolute AND OR RELative,ABSolute AND OR RELative,ABSolute AND OR RELative,ABSolute AND OR RELative	582
[::SENSe]:SEMAsk:OFFSet[1]2:LIST:TEST?	582
[::SENSe]:SEMAsk:OFFSet[1]2:TYPE CTOCenter CTOEdge ETOCenter ETOEdge	595
[::SENSe]:SEMAsk:OFFSet[1]2:TYPE?	595
[::SENSe]:SEMAsk:SWEep[1]2:TIME <time>	555
[::SENSe]:SEMAsk:SWEep[1]2:TIME:AUTO OFF 0 ON 1	555
[::SENSe]:SEMAsk:SWEep[1]2:TIME:AUTO?	555

List of Commands

[[:SENSe]:SEMAsk:SWEEp[1] 2:TIME?	555
[[:SENSe]:SEMAsk:TYPE ?	552
[[:SENSe]:SEMAsk:TYPE PSDRef TPRef SPRef	552
[[:SENSe]:SWEEp:EGATe:CONTRol EDGE LEVel	1203
[[:SENSe]:SWEEp:EGATe:CONTRol?	1203
[[:SENSe]:SWEEp:EGATe:DELay <time>	1199
[[:SENSe]:SWEEp:EGATe:DELay:COMPensation:TYPE OFF SETTled GDELay	1205
[[:SENSe]:SWEEp:EGATe:DELay:COMPensation:TYPE?	1205
[[:SENSe]:SWEEp:EGATe:DELay?	1199
[[:SENSe]:SWEEp:EGATe:HOLDoff <time>	1204
[[:SENSe]:SWEEp:EGATe:HOLDoff:AUTO OFF ON 0 1	1204
[[:SENSe]:SWEEp:EGATe:HOLDoff:AUTO?	1204
[[:SENSe]:SWEEp:EGATe:HOLDoff?	1204
[[:SENSe]:SWEEp:EGATe:LENGth <time>	1200
[[:SENSe]:SWEEp:EGATe:LENGth?	1200
[[:SENSe]:SWEEp:EGATe:METHod LO VIDeo FFT	1200
[[:SENSe]:SWEEp:EGATe:METHod?	1200
[[:SENSe]:SWEEp:EGATe:MINFast?	1207
[[:SENSe]:SWEEp:EGATe:SOURce EXTernal1 EXTernal2 LINE FRAMe RFBurst	1202
[[:SENSe]:SWEEp:EGATe:SOURce?	1202
[[:SENSe]:SWEEp:EGATe:TIME <time>	1199
[[:SENSe]:SWEEp:EGATe:TIME?	1199
[[:SENSe]:SWEEp:EGATe:VIEW ON OFF 1 0	1196
[[:SENSe]:SWEEp:EGATe:VIEW?	1196
[[:SENSe]:SWEEp:EGATe[:STATe] OFF ON 0 1	1194
[[:SENSe]:SWEEp:EGATe[:STATe]?	1194
[[:SENSe]:SWEEp:FFT:WIDTh <real>	1190
[[:SENSe]:SWEEp:FFT:WIDTh:AUTO OFF ON 0 1	1191
[[:SENSe]:SWEEp:FFT:WIDTh:AUTO?	1191
[[:SENSe]:SWEEp:FFT:WIDTh?	1190
[[:SENSe]:SWEEp:POINts <integer>	1207

List of Commands

[[:SENSe]:SWEep:POINts?	1207
[[:SENSe]:SWEep:TIME <time>	1182
[[:SENSe]:SWEep:TIME:AUTO OFF ON 0 1	1182
[[:SENSe]:SWEep:TIME:AUTO:RULes NORMal ACCuracy SRESponse	1183
[[:SENSe]:SWEep:TIME:AUTO:RULes:AUTO[:STATe] ON OFF 1 0.	1185
[[:SENSe]:SWEep:TIME:AUTO:RULes:AUTO[:STATe]?	1185
[[:SENSe]:SWEep:TIME:AUTO:RULes?	1183
[[:SENSe]:SWEep:TIME:AUTO?	1182
[[:SENSe]:SWEep:TIME?	1182
[[:SENSe]:SWEep:TYPE FFT SWEep	1186
[[:SENSe]:SWEep:TYPE:AUTO OFF ON 0 1	1187
[[:SENSe]:SWEep:TYPE:AUTO:RULes SPEed DRANge	1188
[[:SENSe]:SWEep:TYPE:AUTO:RULes:AUTO[:STATe] OFF ON 0 1.	1189
[[:SENSe]:SWEep:TYPE:AUTO:RULes:AUTO[:STATe]?	1189
[[:SENSe]:SWEep:TYPE:AUTO:RULes?	1188
[[:SENSe]:SWEep:TYPE:AUTO?	1187
[[:SENSe]:SWEep:TYPE?	1186
[[:SENSe]:VOLTage:IQ:Q:RANGe[:UPPer] <voltage>	923
[[:SENSe]:VOLTage:IQ:Q:RANGe[:UPPer]?	923
[[:SENSe]:VOLTage:IQ:RANGe:AUTO OFF ON 0 1	920
[[:SENSe]:VOLTage:IQ:RANGe:AUTO?	920
[[:SENSe]:VOLTage:IQ[:I]:RANGe[:UPPer] <voltage>	921
[[:SENSe]:VOLTage:IQ[:I]:RANGe[:UPPer]?	921
[[:SENSe]:VOLTage POWER:IQ:MIRRored OFF ON 0 1	922
[[:SENSe]:VOLTage POWER:IQ:MIRRored?	922
[[:SENSe]:WAVeform:ADC:DITHer:AUTO[:STATe] OFF ON 0 1	883
[[:SENSe]:WAVeform:ADC:DITHer:AUTO[:STATe]?	883
[[:SENSe]:WAVeform:ADC:DITHer[:STATe] OFF ON 0 1	884
[[:SENSe]:WAVeform:ADC:DITHer[:STATe]?	884
[[:SENSe]:WAVeform:APERture?	881
[[:SENSe]:WAVeform:AVERage:COUNt <integer>	878

List of Commands

[[:SENSe]:WAVeform:AVERage:COUNT?	878
[[:SENSe]:WAVeform:AVERage:TACount <integer>	880
[[:SENSe]:WAVeform:AVERage:TACount?	880
[[:SENSe]:WAVeform:AVERage:TCONtrol EXPonential REPeat.	879
[[:SENSe]:WAVeform:AVERage:TCONtrol?	879
[[:SENSe]:WAVeform:AVERage:TYPE LOG MAXimum MINimum RMS SCALar	879
[[:SENSe]:WAVeform:AVERage:TYPE?	879
[[:SENSe]:WAVeform:AVERage[::STATe] OFF ON 0 1	878
[[:SENSe]:WAVeform:AVERage[::STATe]?	878
[[:SENSe]:WAVeform:BANDwidth[::RESolution]	850
[[:SENSe]:WAVeform:DIF:BANDwidth <freq>	849
[[:SENSe]:WAVeform:DIF:BANDwidth?	849
[[:SENSe]:WAVeform:DIF:FILTer:ALPHa <real>	861
[[:SENSe]:WAVeform:DIF:FILTer:ALPHa?	861
[[:SENSe]:WAVeform:DIF:FILTer:BANDwidth <freq>	860
[[:SENSe]:WAVeform:DIF:FILTer:BANDwidth:AUTO ON OFF 1 0	860
[[:SENSe]:WAVeform:DIF:FILTer:BANDwidth:AUTO?	860
[[:SENSe]:WAVeform:DIF:FILTer:BANDwidth?	860
[[:SENSe]:WAVeform:DIF:FILTer:TYPE GAUSSian FLATtop SNYquist RSNYquist RCOSine RRCosine	851
[[:SENSe]:WAVeform:DIF:FILTer:TYPE GAUSSian FLATtop.	851
[[:SENSe]:WAVeform:DIF:FILTer:TYPE?	851
[[:SENSe]:WAVeform:DIF:FILTer:TYPE?	851
[[:SENSe]:WAVeform:IF:GAIN:AUTO[::STATe] ON OFF 1 0.	885
[[:SENSe]:WAVeform:IF:GAIN:AUTO[::STATe]?	885
[[:SENSe]:WAVeform:IF:GAIN:OFFSet <rel_ampl >	886
[[:SENSe]:WAVeform:IF:GAIN:OFFSet?	886
[[:SENSe]:WAVeform:IF:GAIN[::STATe] AUTOOrange LOW HIGH	885
[[:SENSe]:WAVeform:IF:GAIN[::STATe]?	885
[[:SENSe]:WAVeform:SRATe <freq>	881
[[:SENSe]:WAVeform:SRATe?	881
[[:SENSe]:WAVeform:SWEp:TIME <time>.	882

List of Commands

[:SENSe]:WAVeform:SWEEp:TIME?	882
[:SENSe]:WAVeform:WBIF:FILTer:BANDwidth <real>	861
[:SENSe]:WAVeform:WBIF:FILTer:BANDwidth?	861
[:SENSe]:WAVeform:WBIF:FILTer[:TYPE]?	851
[:SENSe]:WAVeform:WBIF:FILTer[:TYPE]	851
CONFigure:EVM:NDEFault	631
CONFigure:EVM	631
FETCh:EVM[n]?	631
GAUSSian NONE NYQuist RNYQuist RCOSine RRCosine	851
INITiate:EVM	631
MEASure:EVM[n]?	631
MMEMory:LOAD:MASK <string>	164
OUTPut:ANALog:AUTO OFF ON 0 1	1031
OUTPut:ANALog:AUTO?	1031
READ:EVM[n]?	631

Welcome to the X-Series Signal Analyzer Help system!

The online Help system is "context-sensitive". This means that the information displayed when you invoke the Help system depends on the selected Analyzer Mode, Measurement and key.

TIP

To view help for any front-panel key or menu key, press that key with this Help Window open.

To scroll any page vertically (to see the whole of a long topic), press the **Down Arrow** key on the front panel to scroll down (or the **Up Arrow** key to scroll up). To locate these keys, see [“Front Panel Keys used by the Help System” on page 93](#).

See [“Navigating the Help Window Without a Mouse” on page 98](#) for complete information about **Using Help without an attached Mouse and Keyboard**. For specific details of how to navigate to topics, see [“Finding a Topic without a Mouse and Keyboard” on page 107](#).

See [“Navigating the Help Window with a Mouse” on page 96](#) to learn about **Using Help with an attached Mouse and Keyboard**.

You can view Help on the Analyzer itself, or you can **View Help on Another Computer**, by copying the Help files and viewing Help there. For details, see the Section [“Viewing Help on a separate Computer” on page 87](#).

To locate **Other Available Help Resources**, see [“Locating Other Help Resources” on page 86](#).

Key Path	Help
----------	------

Locating Other Help Resources

All available documentation is present on the Analyzer's hard disk, either as HTML Help or Acrobat PDF files.

In addition to the interactive Windows (HTML) Help system, the Analyzer's hard disk contains Application Notes, tutorial documents, etc.

This same documentation is also included on the Documentation CD shipped with your Analyzer.

Many of the supporting documents use the Adobe Acrobat (PDF) file format. You can view PDF files using the pre-installed Adobe Reader software.

The Adobe Reader user interface differs from the Windows Help interface. For full details on how to navigate within Acrobat documents using Adobe Reader, see [“Navigating Acrobat \(PDF\) Files” on page 102](#).

Viewing Help on a separate Computer

You may want to view the help pages **without** having them appear on top of the Analyzer's screen.

There are two separate Help files for each Analyzer Mode, which contain all the same help pages in different formats:

1. A file in HTML Help (CHM) format,
2. A file in Acrobat (PDF) format.

You can copy any of the Help files to another computer, then open and view the help pages in the file on that computer.

Your choice of which file to copy and view may depend on what you want to do with the file (for example, whether you want to print it and read the paper copy, or view it on the computer). The table below compares the relative advantages of the two formats:

Format Type	HTML Help Format (CHM Files)	Acrobat Format (PDF Files)
File Extension	CHM	PDF
Software Required to view file	Microsoft Windows operating system only, with Microsoft Internet Explorer installed.	Free Adobe Reader software can be downloaded for many operating systems, including: Microsoft Windows, Macintosh, Linux, Solaris.
Full Text Search?	Yes	Yes
Printable?	Yes, but with limited control.	Yes. Full print control.
Printable Table of Contents?	No	Yes
Navigable without a Mouse and Keyboard?	Yes, but with some loss of functionality.	No
Has Page Numbers?	No	Yes
Context-Sensitive Display?	Yes, when viewed using the X-Series Analyzer application window.	No
Indexed?	Yes	No
Active Hyperlinks?	Yes	Yes

Copying the HTML Help (CHM) Files

You can copy the HTML Help file(s) you need to a separate computer running Microsoft Windows. Each HTML Help file has a .chm extension.

You can find the HTML Help (.chm) files:

- **Either**, on the documentation CD that came with the Analyzer,

- **Or**, in a special directory on the Analyzer's hard disk. The directory path is:
C:\Program Files\Agilent\SignalAnalysis\Infrastructure\Help
The illustration below shows an example listing of the HTML Help files in this directory, viewed using Windows Explorer.
Depending on which Analyzer software licenses you purchased, the content of the directory on your machine may vary.

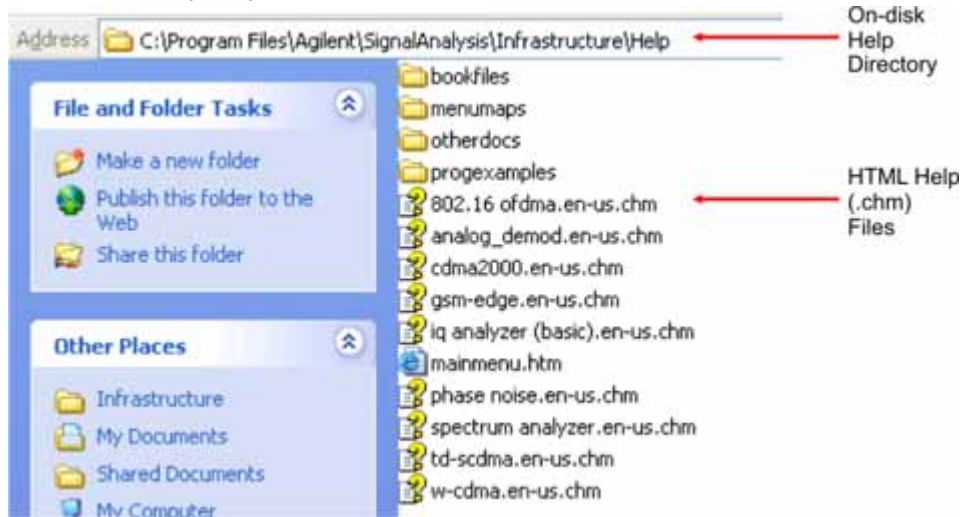

NOTE You can open and view the HTML Help files only on a PC that has Microsoft Windows and Microsoft Internet Explorer installed.

Copying the Acrobat (PDF) Files

You can copy the Acrobat file(s) you need to a separate computer running any of several different operating systems. Each Acrobat file has a .pdf extension.

You can find the Acrobat (.pdf) files:

- **Either**, on the documentation CD that came with the Analyzer,
- **Or**, in a special directory on the Analyzer's hard disk. The directory path is:
C:\Program Files\Agilent\SignalAnalysis\Infrastructure\Help\bookfiles
 - The illustration below shows an example listing of the Acrobat files in this directory, viewed using Windows Explorer.
 - The PDF versions of the help files are named <mode>_ref.pdf, where <mode> is the name of the Analyzer Mode. For example, the name of the PDF file for GSM/EDGE Mode is gsmedge_ref.pdf. (Note that the directory also contains other PDF documents.)
 - When you open any <mode>_ref.pdf document, the title page displays "<Mode> User's and Programmer's Reference", where <Mode> is the name of the Analyzer Mode described by the document.
 - Depending on which Analyzer software licenses you purchased, the content of the directory on your machine may vary.

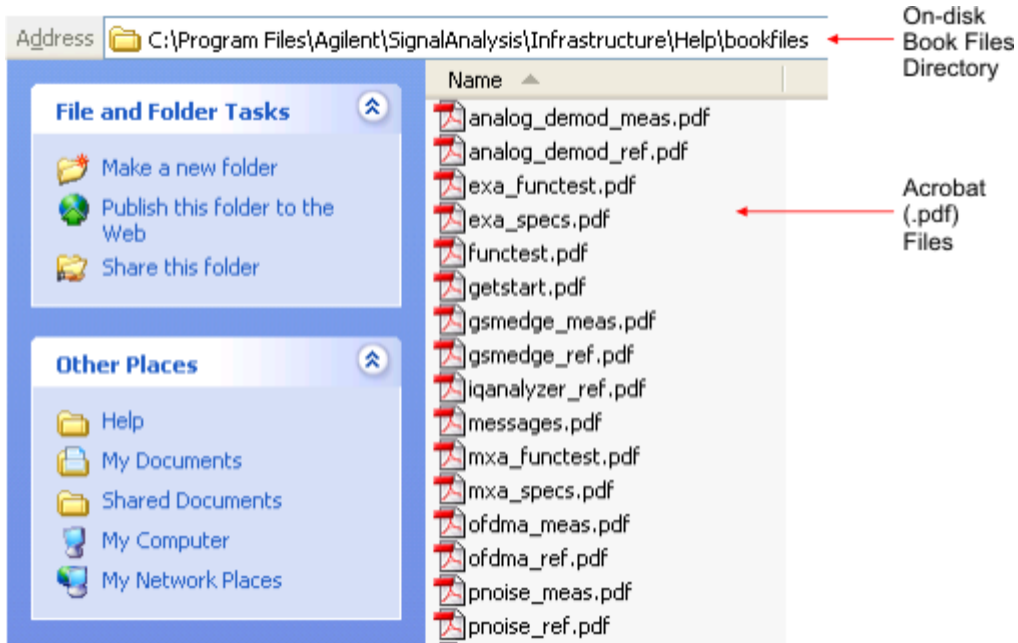

How Help is Organized

This topic contains the following sections:

“Help Contents Listing” on page 90

“System Functions” on page 90

“Key Descriptions for Each Measurement” on page 91

“Key Information for Softkeys” on page 91

“Common Measurement Functions” on page 92

Help Contents Listing

The listing under the Contents tab in the Help Window includes a topic for each Front-panel key and each softkey, for each available measurement.

The Contents listing is split into several major sections, as shown below for the HTML Help version of the document. The structure of the PDF version is similar.

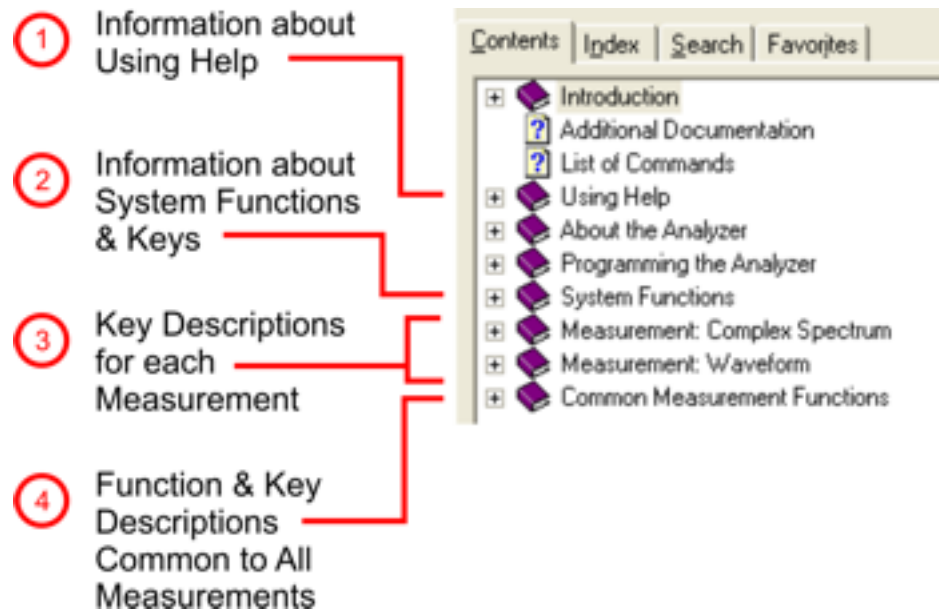

Help information is split between these sections as follows:

1. Using Help: this section.
2. System Functions. See “[System Functions](#)” on page 90 below.
3. Measurement Functions. See “[Key Descriptions for Each Measurement](#)” on page 91 below.
4. Common Measurement Functions. See “[Common Measurement Functions](#)” on page 92 below.

System Functions

This section contains information for the following keys, which are listed in alphabetical order: **File**,

Preset, Print, Quick Save, Recall, Save, System, User Preset.

The functions of these keys do not vary between measurements: they operate the same way, irrespective of which Analyzer measurement you have selected.

The sections for **Recall** and **Save** contain only cross-references to the respective sections in “[Common Measurement Functions](#)” on page 92, and are included here for convenience.

Key Descriptions for Each Measurement

The Contents section for each Measurement is sub-divided into topics for each Front-panel key, in alphabetical order, as shown below.

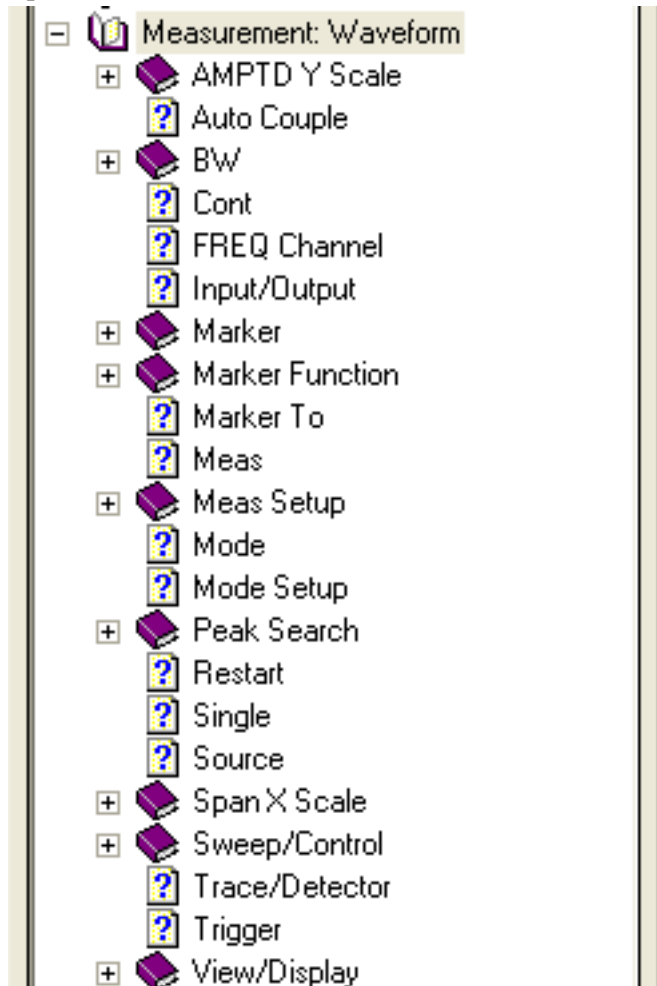

If you don't see a topic for a Front-panel key in the Measurement-specific section, then it is located in the section “[System Functions](#)” on page 90.

Key Information for Softkeys

Information for each softkey that appears when you press a Front-panel key (or a softkey with a submenu) is listed under the entry for that key in the Help Contents. The example below shows the submenu under the **SPAN X Scale** Front-panel key in the "Waveform" Measurement, alongside the

Using Help
How Help is Organized

actual softkeys for that menu.

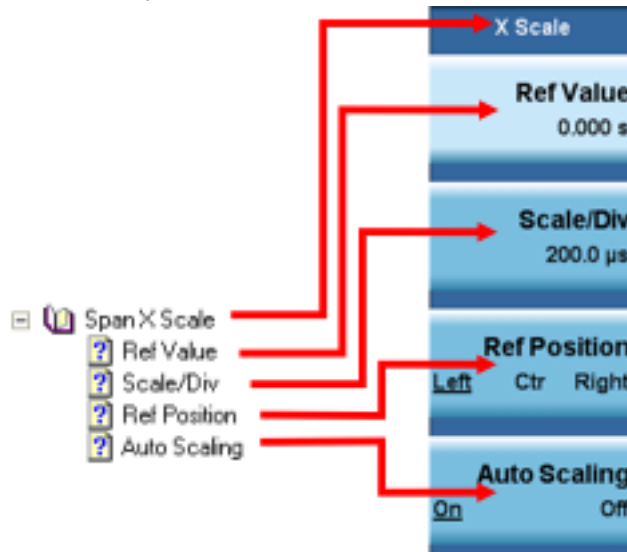

In these subsections, all softkeys are listed in the order they appear in their menu (that is, **not** in alphabetical order).

Common Measurement Functions

This section groups together function and key information that is shared between measurements. However, there is a listing for every Front-panel key and subkey in the section for each measurement, so you will generally not need to refer to this section.

The key subsections are listed alphabetically.

Front Panel Keys used by the Help System

The interactive Help system uses the Front-panel keys shown below.

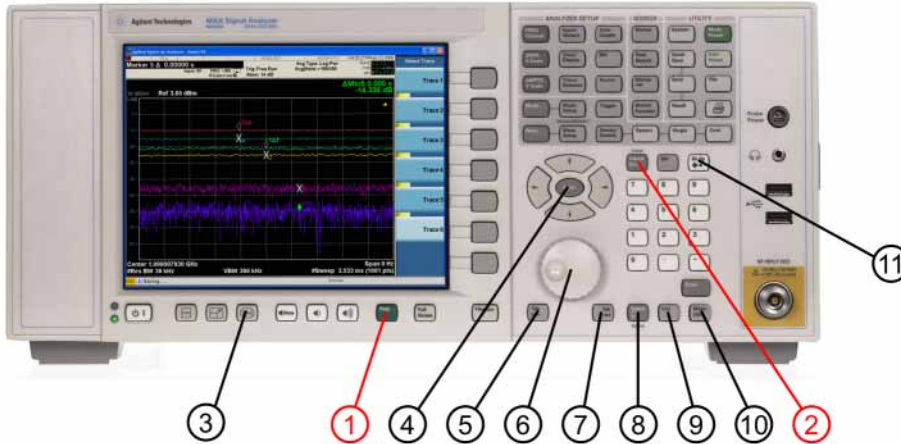

#	Item Name	Description
1	Help Key	Opens Help (displaying the topic for the last key pressed).
2	Cancel (Esc) Key	Exits Help.
3	Next Window Key	Changes the current window pane selection.
4	Arrow / Enter Keys	A central Enter key, surrounded by four directional arrow keys. Navigates within the Help system.
5	Backward Tab Key	Moves between controls in the Help display.
6	Knob	For future use.
7	Forward Tab Key	Moves between controls in the Help display.
8	Select / Space Key	Navigates within the Help system, in conjunction with other keys.
9	Ctrl Key	Navigates within the Help system, in conjunction with other keys. See “Navigating Windows HTML Help (CHM) Files” on page 94.
10	Alt Key	Navigates within the Help system, in conjunction with other keys. See “Navigating Windows HTML Help (CHM) Files” on page 94.
11	Bk Sp (Backspace) Key	Acts as a "Back" key when navigating the pages of the Help system.

Navigating Windows HTML Help (CHM) Files

HTML Help Window Components

When the interactive Help Window is open, the Analyzer's display appears as below.

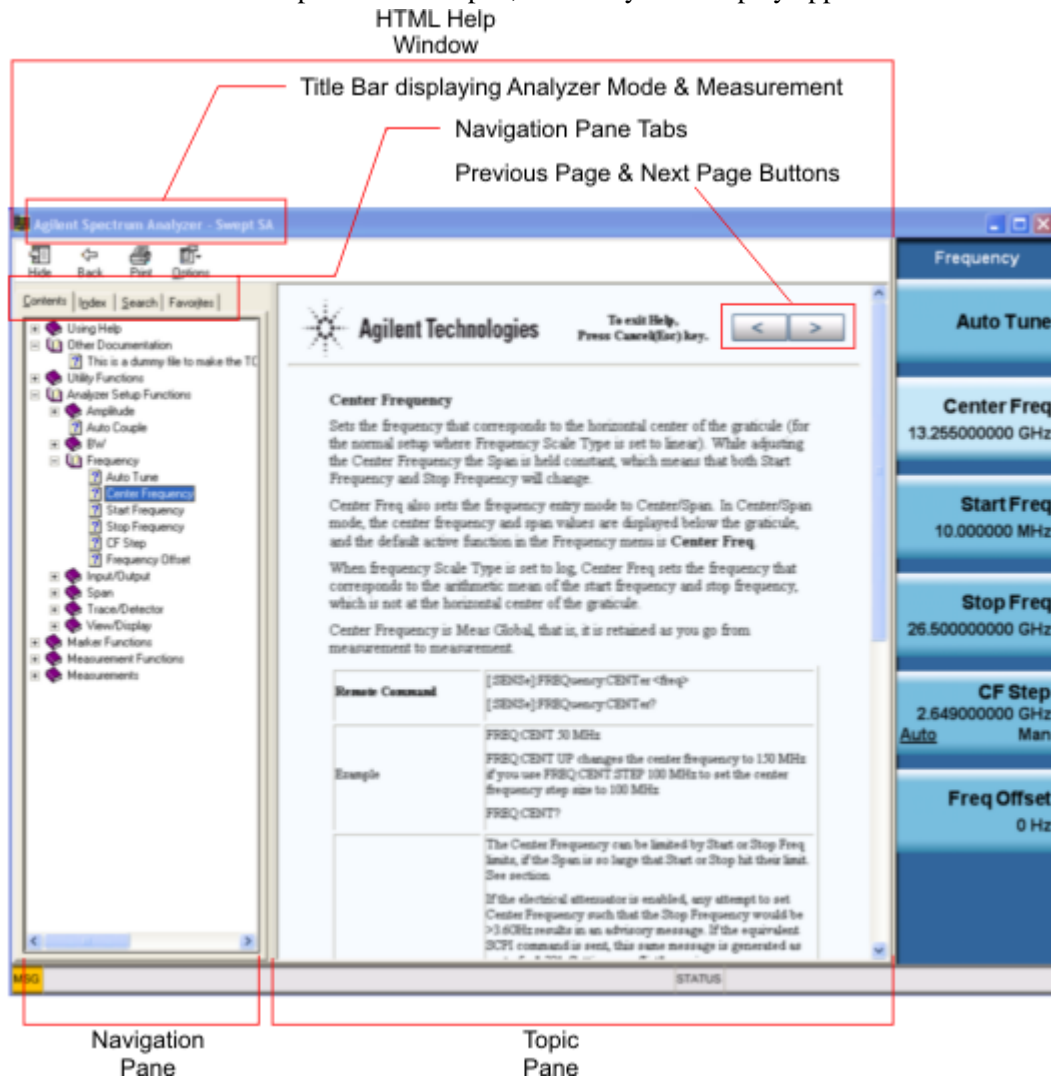

The HTML Help Window appears on top of, and to the left of, the measurement display. You can still see and use the current softkey menu when the HTML Help Window is open. However, pressing a softkey when the Help window is open displays Help for that softkey, but does **not** execute the softkey's function.

When the Help Window is open, the Analyzer retains its current Mode and Measurement, as shown in the Title Bar.

The HTML Help Window itself consists of two panes, as shown in the diagram above.

On the left is the Navigation Pane, and on the right is the Topic Pane.

The Help Window Navigation Pane

The Navigation Pane is further divided into four tabs: Contents, Index, Search and Favorites, as shown below.



For details of how to switch between these tabs, if you don't have a mouse attached to the Analyzer, see the Section [“To Switch the Active Tab within the Navigation Pane” on page 98](#).

The Help Window Topic Pane

This pane displays the text for the topic that you have selected. It also contains clickable **Previous Page** and **Next Page** buttons (as shown below), which can be used to move to the previous or next page in the Help file.



Basic Help Window Operations

This topic contains the following sections:

[“Opening Help” on page 95](#)

[“Getting Help for a Specific Key” on page 95](#)

[“Closing the Help Window” on page 96](#)

[“Viewing Help on How to Use Help” on page 96](#)

[“Exiting Help on How to Use Help” on page 96](#)

To locate the keys mentioned in this section, see [“Front Panel Keys used by the Help System” on page 93](#).

Opening Help

To access the Help system, press the green **Help** key below the front panel display (shown below) while an Agilent application is running.



Note that the softkeys remain visible when the Help window is open.

Getting Help for a Specific Key

1. If the Help window **is** already open, press the desired key. The relevant Help topic appears.

Note that the function normally invoked by the key is **not** executed when the key is pressed with the Help window open. If you want to execute the key's function, first close Help by pressing the **Cancel (Esc)** key (as described in [“Closing the Help Window” on page 96](#)), then press the key, before opening Help again (if required).

2. If the Help window is **not** already open, press the desired key (which executes the key's function), then press the **Help** key to display the relevant Help page. Help is available for all softkeys, and for

Using Help

Navigating Windows HTML Help (CHM) Files

all the Front-panel keys listed under the "System Functions" and "Measurement" sections.

For details of how to navigate within the panes of the Help window, see “[Navigating Windows HTML Help \(CHM\) Files](#)” on page 94.

Closing the Help Window

To close the Help window, and return to the measurement application, press the **Cancel (Esc)** key (depicted below).



Viewing Help on How to Use Help

With the Help window open, press the green **Help** key again.

The "Using Help" page appears, as shown below.



Exiting Help on How to Use Help

See the Section “[To Go Back or Forward: display the Previously-viewed or Next-viewed Topic in the Topic Pane](#)” on page 100 for details of several methods to accomplish this.

Navigating the Help Window

The way you navigate around the HTML Help Window depends on whether you have a mouse and keyboard attached to your Analyzer:

- If you have a mouse and keyboard attached, see the Section “[Navigating the Help Window with a Mouse](#)” on page 96.
- If you don't have a mouse and keyboard attached, see the Section “[Navigating the Help Window Without a Mouse](#)” on page 98.

Navigating the Help Window with a Mouse

When the HTML Help window is open, you can point-and-click to navigate, as you would when using Help for any Microsoft Windows computer application. The basic navigational features the Help systems of all X-Series Analyzers are as follows:

- If necessary, press the green **Help** key on the Front Panel, as described in “[Opening Help](#)” on page 95, to open the HTML Help window.

- Choose the desired topic from the list under the Contents Tab of the HTML Help Window's Navigation Pane, then click on the topic title to display the first page of the topic.
- To expand the listing of a topic, click on the + icon to the left of the topic's book icon, as shown below. A list of subtopics and pages appears.

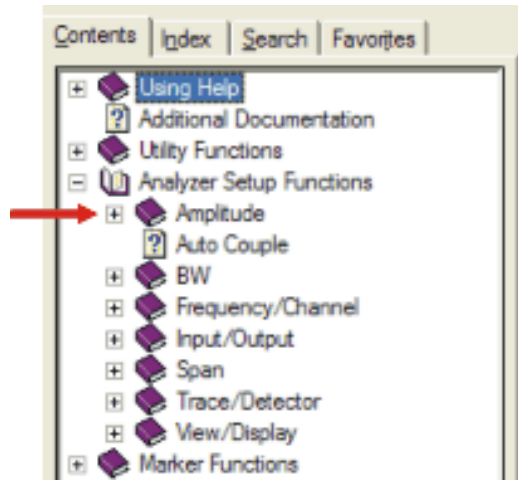

- To move to the Next or Previous Page within the Topic Pane, click the **Next Page** or **Previous Page** Keys (at the top right of the **Topic** Pane), as shown below.



Searching for a Help Topic If you also have a keyboard attached to the Analyzer, you can use the Help system's full-text search feature to locate help for any topic, by typing in a key name, a topic name, or any other desired text.

Select the "Search" tab of the Help window's Navigation Pane, then use the following procedure:

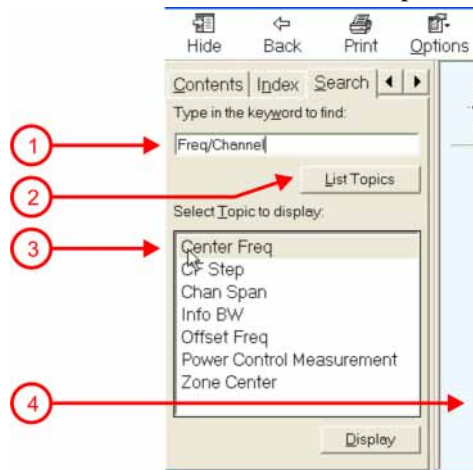

1. Type the desired topic name into the Search window as shown in the diagram above. Note that the text search is **not** case-sensitive.
2. Click on the **List Topics** button.
3. **Either:**
Double-click on the desired topic in the list,

Or:

Click on the desired topic to select it, then click the **Display** button beneath the list.

4. The topic is then displayed in the Topic Pane (right-hand side of display).

Navigating the Help Window Without a Mouse

Most features of the Help system can be accessed and navigated without the necessity to attach a mouse or keyboard to the Analyzer. There are, however, a few exceptions to this rule, which are noted in the Section [“Functions that cannot be used without a Mouse and Keyboard” on page 101](#).

For information about how to perform common tasks in the Help system, click on one of the following links:

[“To Toggle the Focus between the Navigation Pane and the Topic Pane” on page 98](#)

[“To Switch the Active Tab within the Navigation Pane” on page 98](#)

[“To Scroll up or down the list of Topics within the Contents or Index Tabs of the Navigation Pane” on page 99](#)

[“To Expand or Collapse a selected topic within the Contents Tab of the Navigation Pane” on page 99](#)

[“To Display a selected Help topic in the Topic Pane from the Contents Tab of the Navigation Pane” on page 99](#)

[“To Display a Help topic in the Topic Pane from the Index Tab of the Navigation Pane” on page 99](#)

[“To Scroll up or down within a topic in the Topic Pane” on page 99](#)

[“To Go to the Next or Previous Page in the Topic Pane” on page 100](#)

[“To Go Back or Forward: display the Previously-viewed or Next-viewed Topic in the Topic Pane” on page 100](#)

[“To Scroll horizontally or vertically within the Contents Tab of the Navigation Pane” on page 101](#)

[“To Print the topic currently displayed” on page 101](#)

To locate all the keys mentioned in this section, see [“Front Panel Keys used by the Help System” on page 93](#).

To Toggle the Focus between the Navigation Pane and the Topic Pane Press the **Next Window** key.



To Switch the Active Tab within the Navigation Pane Perform this procedure to display either the Contents, Index, Search or Favorites tab of the Help window’s Navigation Pane.

Hold down the **Ctrl** key, then press either the **Forward Tab** key, or the **Backward Tab** key.



To Scroll up or down the list of Topics within the Contents or Index Tabs of the Navigation Pane

With the focus in the Navigation Pane, press the **Up Arrow** or **Down Arrow** keys.



To Expand or Collapse a selected topic within the Contents Tab of the Navigation Pane With the focus in the Navigation Pane, press the **Right Arrow** key to **expand** the selected topic:



Or press the **Left Arrow** key to **collapse** the selected topic.



To Display a selected Help topic in the Topic Pane from the Contents Tab of the Navigation Pane

With the focus in the Contents Tab of the Navigation Pane, press the **Enter** key. If the selected topic was not already expanded, it expands in the Navigation Pane.



To Display a Help topic in the Topic Pane from the Index Tab of the Navigation Pane With the focus in the Index Tab of the Navigation Pane, press the **Enter** key.



To Scroll up or down within a topic in the Topic Pane With the focus in the Topic Pane, press either

Using Help
Navigating Windows HTML Help (CHM) Files

the **Up Arrow** key or **Down Arrow** key.



To Go to the Next or Previous Page in the Topic Pane With the focus in the Topic Pane, press either **Forward Tab** or **Backward Tab** keys



to select the **> (Next Page)** key at the top right of the Pane, if you want to go to the **next** page,



or select the **< (Previous Page)** key at the top left of the Pane, if you want to go to the **previous** page.



Press **Enter**.



To Go Back or Forward: display the Previously-viewed or Next-viewed Topic in the Topic Pane

To go **back**, either:

Hold down the **Alt** key, then press the **Left Arrow** key.

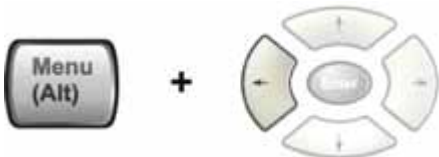

Or:

Press the **Bk Sp** key.



To go **forward**, hold down the **Alt** key, then press the **Right Arrow** key.

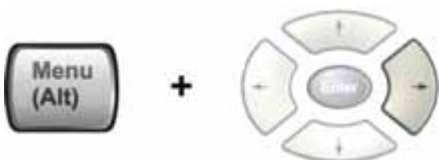

(The "Go Forward" operation has no effect unless there have been previous "Go Back" operations)

To Scroll horizontally or vertically within the Contents Tab of the Navigation Pane To scroll **horizontally**: with the focus in the Contents Tab of the Navigation Pane, hold down the **Ctrl** key, then press either the **Left Arrow** or **Right Arrow** keys.

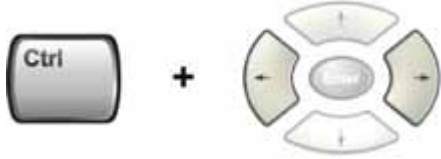

To scroll **vertically**: with the focus in the Contents Tab of the Navigation Pane, hold down the **Ctrl** key, then press either the **Up Arrow** or **Down Arrow** keys.

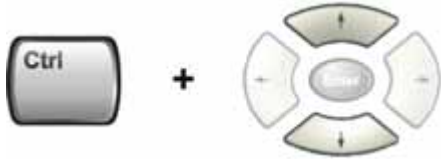

To Print the topic currently displayed Press the Front-panel **Print** key



Functions that cannot be used without a Mouse and Keyboard The following parts of the HTML Help System **cannot** easily be used without attaching a mouse and keyboard to the Analyzer.

- The menu options at the top of the Help Window, consisting of: **Hide, Back, Print** and **Options**.
- The functionality of the Search Tab of the Navigation Pane.
- The functionality of the Favorites Tab of the Navigation Pane.

Navigating Acrobat (PDF) Files

IMPORTANT To navigate PDF files effectively, you must attach a mouse and keyboard to the Analyzer.

If it is not possible to attach a mouse and keyboard to the Analyzer, you should copy the PDF file to a separate computer, then open it on that computer. Every PDF file that is present on the Analyzer's hard disk can also be found on the Documentation CD shipped with the Analyzer. For details, see ["Copying the Acrobat \(PDF\) Files" on page 88.](#)

Adobe Reader Window

When an Adobe Acrobat (PDF) file is open and being viewed, the Analyzer's display appears as below.

Note that, unlike the HTML Help Window, the Acrobat Reader Window is **not** embedded in the Analyzer's Application window. It is a separate window, which can be resized, moved and closed independently of the Application window.

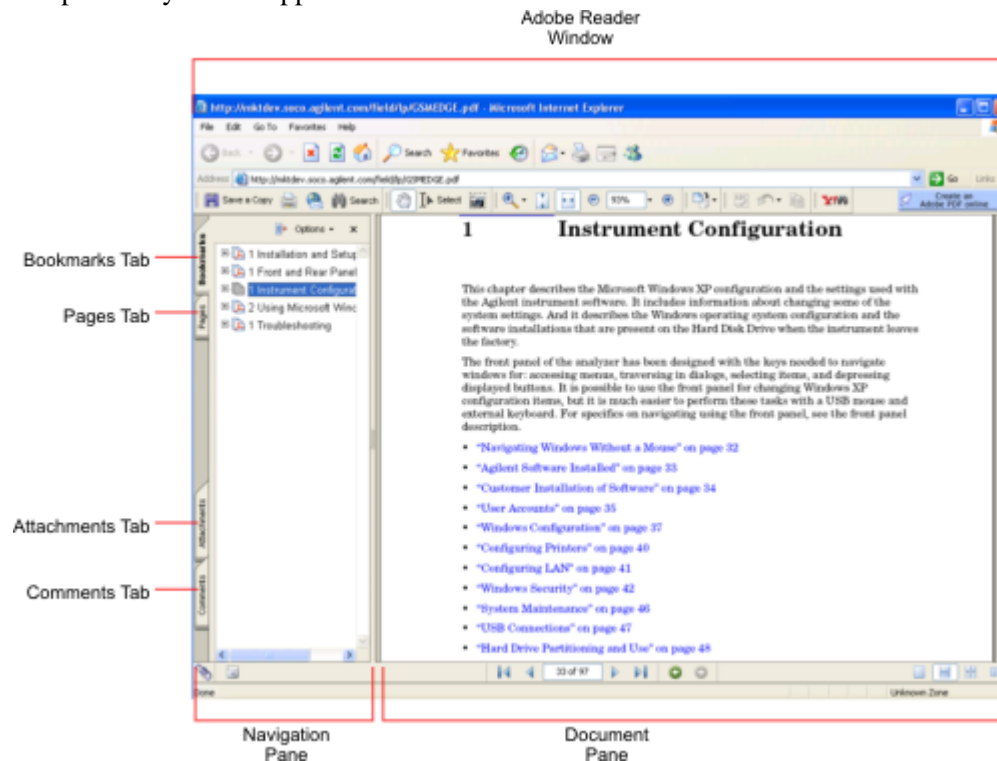

The Adobe Reader Window itself consists of two panes, as shown in the diagram above.

On the left is the Navigation Pane (which may be hidden), and on the right is the Document Pane.

The Navigation Pane is further subdivided into four tabs: Bookmarks, Pages, Attachments and Comments. Typically, PDF files supplied with the Agilent X-Series Analyzers contain useful content only under the Bookmarks and Pages Tabs: the Attachments and Comments Tabs are not used.

Navigating the Acrobat Reader Window

The online Help for Adobe Reader provides detailed information on how to use the Reader. To access the online Help, do the following:

- With the Adobe Reader window open, click **Help, Adobe Reader Help** in the menu at the top of the screen. This opens the Help window on top of the document window.
- To close the Help window, **either** click the Red **X** at the top right of the window, **or** right-click



anywhere in the title bar, then select **Close** from the popup menu.

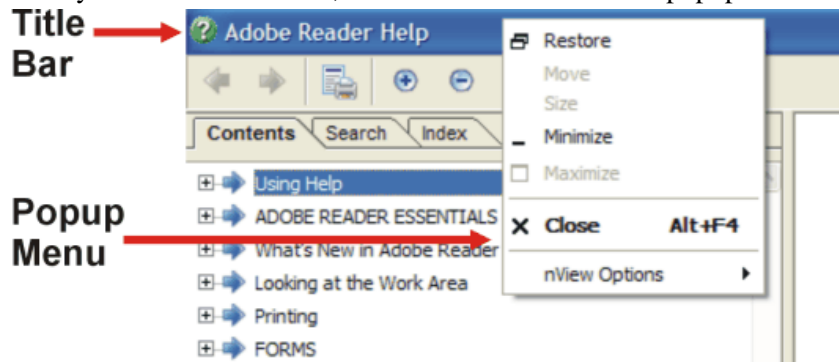

Printing Acrobat Files

NOTE The driver for the appropriate printer must be installed on the Analyzer's hard disk before any file can be printed.

To print all or part of an open Acrobat file, do the following.

1. **Either,**
 - a. click on the Print icon in the Acrobat Reader toolbar,



- b. **or,** select File > Print from the menu.

Terms Used in This Documentation

Many special terms are used throughout this documentation. Please refer to the "Getting Started Guide" for detailed explanations of all these terms.

The Section below provides a brief description of special terms used in the Key parameter tables.

Terms used in Key Parameter Tables

The following terms are used in the parameter tables for each front-panel key or softkey. However, a particular key description may not use all the terms listed.

Term	Meaning
Default Unit	The default measurement unit of the setting.
Default Terminator	Indicates the units that will be attached to the numeric value that you have entered. This default will be used from the front panel, when you terminate your entry by pressing the Enter key, rather than selecting a units key. This default will be used remotely when you send the command without specifying any units after your value(s).
Dependencies/ Couplings	Some commands may be unavailable when other parameters are set in certain ways. If applicable, any such limitations are described here.
Example	Provides command examples using the indicated remote command syntax.
Factory Preset	Describes the function settings after a Factory Preset .
Key Path	The sequence of Front-panel keys that accesses the function or setting.
Knob Increment/Decrement	The numeric value of the minimum increment or decrement that is applied when turning the thumb wheel knob.
Max	The Maximum numerical value that the setting can take.
Min	The Minimum numerical value that the setting can take.
Meas Global	The functionality described is the same in all measurements.
Meas Local	The functionality described is only true for the measurement selected.
Mode Global	The functionality described is the same for all modes.
Preset	In some cases, a Preset operation changes the status of a parameter. If the operation of the key specified is modified by a Preset operation, the effect is described here.
Range	Describes the range of the smallest to largest values to which the function can be set. If you try to set a value below the minimum value, the analyzer defaults to the minimum value. If you try to set a value above the maximum value, the analyzer defaults to the maximum value.
Remote Command	Shows the syntax requirements for each SCPI command.

Term	Meaning
Remote Command Notes	Additional notes regarding Remote Commands.
Resolution	Specifies the smallest change that can be made to the numeric value of a parameter.
SCPI Status Bits/OPC Dependencies	Pressing certain keys may affect one or more status bits. If applicable, details are given here.
State Saved	Indicates what happens to a particular function when the Analyzer state is saved (either to an external memory device or the internal D: drive). It also indicates whether the current settings of the function are maintained if the Analyzer is powered on or preset using Power On Last State or User Preset .

Context Sensitive Help not Available

You have been directed to this page because interactive help for the key you selected is not available.



The following information may help you to find related topics of interest:

- If your Analyzer has an attached Mouse and Keyboard, see the Section [“Searching for a Help Topic” on page 97](#).
- If your Analyzer does **not** have an attached Mouse and Keyboard, see the Section [“Finding a Topic without a Mouse and Keyboard” on page 107](#) below.
- If you want to learn how to select on-page links **without** a Mouse attached to your Analyzer, see the Section [“Selecting a Hyperlink without a Mouse” on page 108](#) below.

TIP If you want to understand the organization of Help, see the Section [“How Help is Organized” on page 90](#).





Finding a Topic without a Mouse and Keyboard

Follow this procedure when you want to display a different Help topic by selecting it from the Contents tab of the Help window’s Navigation Pane, but you do not have a mouse attached to the Analyzer.

Perform this action:	Using these keys:
1. If necessary, toggle the focus between the Contents tab of the Navigation Pane (left side of display) and the Topic Pane (right side of display) by pressing the Next Window key. Ensure that the focus is in the Contents tab of the Navigation Pane .	
2. Move up or down the Contents list, by pressing the Up Arrow or Down Arrow keys. Topics become highlighted upon selection.	
3. Display the selected topic, by pressing the Enter key.	

Selecting a Hyperlink without a Mouse

Follow this procedure when you want to select and follow a hyperlink on a Help page, but you do not have a mouse attached to the Analyzer.

Perform this action:	Using these keys:
<p>1. If necessary, toggle the focus between the Contents tab of the Navigation Pane (left side of display) and the Topic Pane (right side of display) by pressing the Next Window key.</p> <p>Ensure that the focus is in the Topic Pane.</p>	
<p>2. Move from link to link in the Topic Pane (right side of display) by pressing the Forward Tab and Backward Tab keys. Links become highlighted upon selection.</p> <p>NOTE: When a Help page is first displayed, no link is selected. Clicking the Forward Tab key once selects the Previous Page key. Clicking the Forward Tab key a second time selects the Next Page key. Clicking the Forward Tab key for a third time selects the first hyperlink on the page.</p> <p>It is sometimes difficult to see the highlighting of the Previous and Next Page keys.</p>	<p>Use the Forward and Backward Tab keys</p>  <p>to select the Previous and Next Page keys</p> 
<p>3. When you have selected the desired link, activate it by pressing the Enter key.</p>	

The X-Series signal analyzer measures and monitors complex RF and microwave signals. Analog baseband analysis is available on MXA. The analyzer integrates traditional spectrum measurements with advanced vector signal analysis to optimize speed, accuracy, and dynamic range. The analyzer has Windows XP Pro[®] built in as an operating system, which expands the usability of the analyzer.

With a broad set of applications and demodulation capabilities, an intuitive user interface, outstanding connectivity and powerful one-button measurements, the analyzer is ideal for both R&D and manufacturing engineers working on cellular, emerging wireless communications, general purpose, aerospace and defense applications.

Installing Application Software

When you want to install a measurement application after your initial hardware purchase, you actually only need to license it. All of the available applications are loaded in your analyzer at the time of purchase.

So when you purchase an application, you will receive an entitlement certificate that is used to obtain a license key for that particular measurement application. Enter the license key that you obtain into the Signal Analyzer to activate the new measurement application. See below for more information.

For the latest information on Agilent Signal Analyzer measurement applications and upgrade kits, visit the following internet URL.

http://www.agilent.com/find/sa_upgrades

Viewing a License Key

Measurement personalities purchased with your instrument have been installed and activated at the factory before shipment. The instrument requires a unique **License Key** for every measurement application purchased. The license key is a hexadecimal string that is specific to your measurement application, instrument model number and serial number. It enables you to install, or reactivate that particular application.

Press **System, Show, System** to display which measurement applications are currently licensed in your analyzer.

Go to the following location to view the license keys for the installed measurement applications:

C:\Programing Files\Agilent\Licensing

NOTE	You may want to keep a copy of your license key in a secure location. You can print out a copy of the display showing the license numbers to do this. If you should lose your license key, call your nearest Agilent Technologies service or sales office for assistance.
-------------	---

Obtaining and Installing a License Key

If you purchase an additional application that requires installation, you will receive an “Entitlement Certificate” which may be redeemed for a license key for one instrument. Follow the instructions that accompany the certificate to obtain your license key.

Installing a license key for the selected application can be done automatically using a USB memory device. To do this, you would put the license file on the USB memory device at the root level. Follow the instructions that come with your software installation kit.

Installing a license key can also be done manually using the license management application in the instrument. It is found through the instrument front panel keys at **System, Licensing. . .**, or internally at C:\Programming Files\Agilent\Licensing.

NOTE You can also use these procedures to reinstall a license key that has been accidentally deleted, or lost due to a memory failure.

Missing and Old Measurement Application Software

All the software applications were loaded at the time of original instrument manufacture. It is a good idea to regularly update your software with the latest available version. This assures that you get any improvements and expanded functionality that is available.

Because the software was loaded at the initial purchase, there may be additional measurement applications that are now available. If the application you are interested in licensing is not available, you will need to do a software update. (Press **System, Show, System.**)

Check the Agilent internet website for the latest software versions available for downloading:

http://www.agilent.com/find/pxa_software
http://www.agilent.com/find/mxa_software
http://www.agilent.com/find/exa_software
http://www.agilent.com/find/cxa_software

You must load the updated software package into the analyzer from a USB drive, or directly from the internet. An automatic loading program is included with the files.

X-Series Options and Accessories

Advanced Measurement Application Software

For a current list of application software, go to the following URLs.

For PXA,

<http://www.agilent.com/find/pxa/options>

Select the **PXA N9030A, Options and Measurement Applications** link on the top of the page.

For MXA,

<http://www.agilent.com/find/mxa/options>

Select the **MXA N9020A, Options and Measurement Applications** link on the top of the page.

For EXA,

<http://www.agilent.com/find/exa/options>

Select the **EXA N9010A, Options and Measurement Applications** link on the top of the page.

For CXA,

<http://www.agilent.com/find/cxa/options>

Select the **CXA N9000A, Options and Measurement Applications** link on the top of the page.

Front-Panel Features

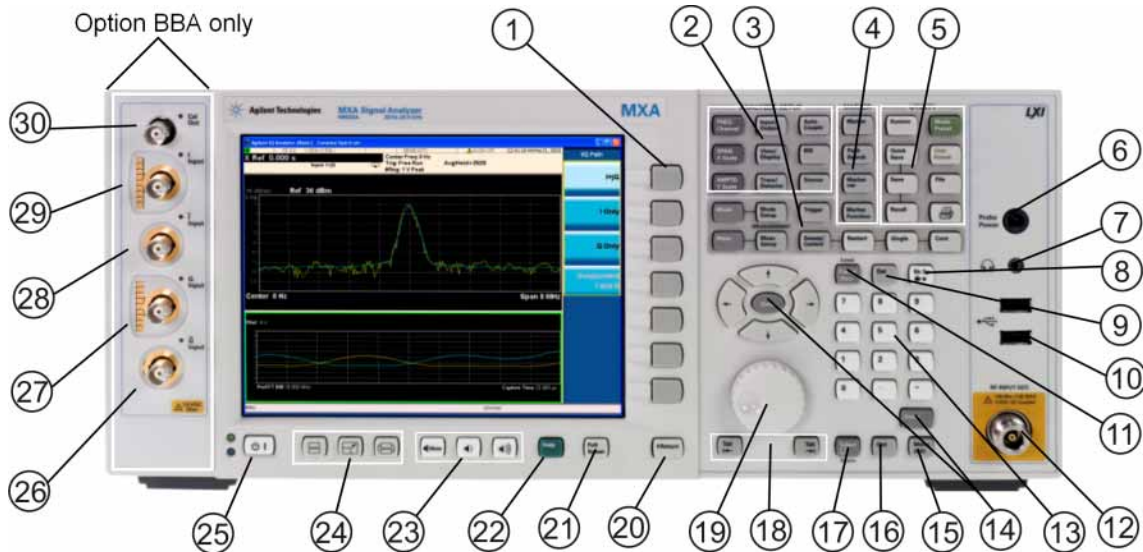

Item		Description
#	Name	
1	Menu Keys	Key labels appear to the left of the menu keys to identify the current function of each key. The displayed functions are dependent on the currently selected Mode and Measurement, and are directly related to the most recent key press.
2	Analyzer Setup Keys	These keys set the parameters used for making measurements in the current Mode and Measurement.
3	Measurement Keys	These keys select the Mode, and the Measurement within the mode. They also control the initiation and rate of recurrence of measurements.
4	Marker Keys	Markers are often available for a measurement, to measure a very specific point/segment of data within the range of the current measurement data.
5	Utility Keys	These keys control system-wide functionality such as: <ul style="list-style-type: none"> • instrument configuration information and I/O setup, • printer setup and printing, • file management, save and recall, • instrument presets.
6	Probe Power	Supplies power for external high frequency probes and accessories.
7	Headphones Output	Headphones can be used to hear any available audio output.
8	Back Space Key	Press this key to delete the previous character when entering alphanumeric information. It also works as the Back key in Help and Explorer windows.

About the Analyzer
Front-Panel Features

Item		Description
#	Name	
9	Delete Key	Press this key to delete files, or to perform other deletion tasks.
10	USB Connectors	Standard USB 2.0 ports, Type A. Connect to external peripherals such as a mouse, keyboard, DVD drive, or hard drive.
11	Local/Cancel/(Esc) Key	<p>If you are in remote operation, Local:</p> <ul style="list-style-type: none"> • returns instrument control from remote back to local (the front panel). • turns the display on (if it was turned off for remote operation). • can be used to clear errors. (Press the key once to return to local control, and a second time to clear error message line.) <p>If you have not already pressed the units or Enter key, Cancel exits the currently selected function without changing its value.</p> <p>Esc works the same as it does on a PC keyboard. It:</p> <ul style="list-style-type: none"> • exits Windows dialogs • clears errors • aborts printing • cancels operations.
12	RF Input	Connector for inputting an external signal. Make sure that the total power of all signals at the analyzer input does not exceed +30 dBm (1 watt).
13	Numeric Keypad	Enters a specific numeric value for the current function. Entries appear on the upper left of the display, in the measurement information area.
14	Enter and Arrow Keys	<p>The Enter key terminates data entry when either no unit of measure is needed, or you want to use the default unit.</p> <p>The arrow keys:</p> <ul style="list-style-type: none"> • Increment and decrement the value of the current measurement selection. • Navigate help topics. • Navigate, or make selections, within Windows dialogs. • Navigate within forms used for setting up measurements. • Navigate within tables. <p>NOTE The arrow keys cannot be used to move a mouse pointer around on the display.</p>
15	Menu/ (Alt) Key	Alt works the same as a PC keyboard. Use it to change control focus in Windows pull-down menus.
16	Ctrl Key	Ctrl works the same as a PC keyboard. Use it to navigate in Windows applications, or to select multiple items in lists.
17	Select / Space Key	Select is also the Space key and it has typical PC functionality. For example, in Windows dialogs, it selects files, checks and unchecks check boxes, and picks radio button choices. It opens a highlighted Help topic.
18	Tab Keys	Use these keys to move between fields in Windows dialogs.
19	Knob	Increments and decrements the value of the current active function.
20	Return Key	Exits the current menu and returns to the previous menu. Has typical PC functionality.

Item		Description
#	Name	
21	Full Screen Key	Pressing this key turns off the softkeys to maximize the graticule display area. Press the key again to restore the normal display.
22	Help Key	Initiates a context-sensitive Help display for the current Mode. Once Help is accessed, pressing a front panel key brings up the help topic for that key function.
23	Speaker Control Keys	Enables you to increase or decrease the speaker volume, or mute it.
24	Window Control Keys	These keys select between single or multiple window displays. They zoom the current window to fill the data display, or change the currently selected window. They can be used to switch between the Help window navigation pane and the topic pane.
25	Power Standby/ On	<p>Turns the analyzer on. A green light indicates power on. A yellow light indicates standby mode.</p> <p>NOTE The front-panel switch is a standby switch, not a LINE switch (disconnecting device). The analyzer continues to draw power even when the line switch is in standby.</p> <p>The main power cord can be used as the system disconnecting device. It disconnects the mains circuits from the mains supply.</p>
26	\bar{Q} Input	Input port for the \bar{Q} channel when in differential mode.*
27	Q Input	Input port for the Q channel for either single or differential mode.*
28	\bar{I} Input	Input port for the \bar{I} channel when in differential mode.*
29	I Input	Input port for the I channel for either single or differential mode.*
30	Cal Out	Output port for calibrating the I, \bar{I} , Q and \bar{Q} inputs and probes used with these inputs.*

*. Status of the LED indicates whether the current state of the port is active (green) or is not in use (dark).

Overview of key types

The keys labeled **FREQ Channel**, **System**, and **Marker Function** are all examples of front-panel keys.



Most of the dark or light gray keys access menus of functions that are displayed along the right side of the display. These displayed key labels are next to a column of keys called menu keys.

Menu keys list functions based on which front-panel key was pressed last. These functions are also dependant on the current selection of measurement application (**Mode**) and measurement (**Meas**).

If the numeric value of a menu key function can be changed, it is called an active function. The function label of the active function is highlighted after that key has been selected. For example, press **AMPTD Y Scale**. This calls up the menu of related amplitude functions. The function labeled **Ref Level** (the default selected key in the Amplitude menu) is highlighted. **Ref Level** also appears in the upper left of the display in the measurement information area. The displayed value indicates that the function is selected and its value can now be changed using any of the data entry controls.

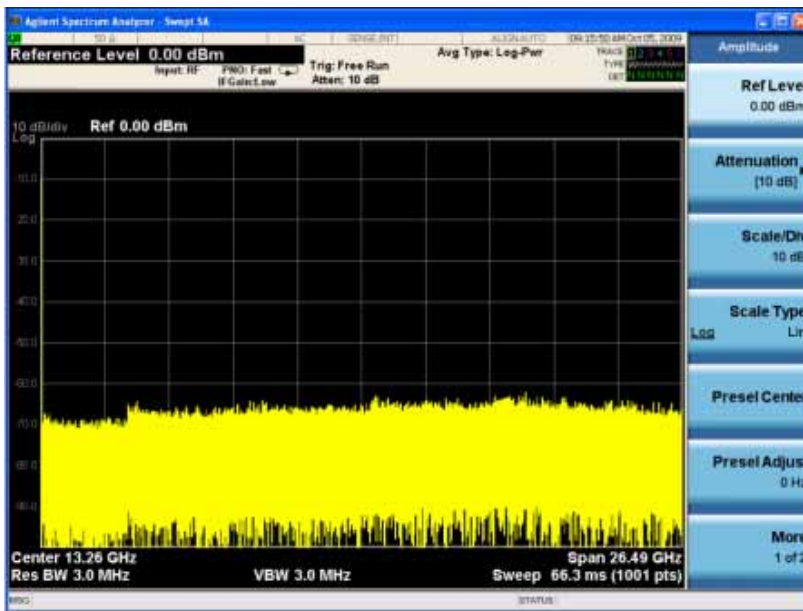

Some menu keys have multiple choices on their label, such as **On/Off**, **Auto/Man**, or **Log/Lin** (as shown above). The different choices are selected by pressing the key multiple times. For example, the Auto/Man type of key. To select the function, press the menu key and notice that Auto is underlined and the key becomes highlighted. To change the function to manual, press the key again so that Man is underlined. If there are more than two settings on the key, keep pressing it until the desired selection is underlined.

When a menu first appears, one key label is highlighted to show which key is the default selection. If you press **Marker Function**, the **Marker Function Off** key is the menu default key, and is highlighted.

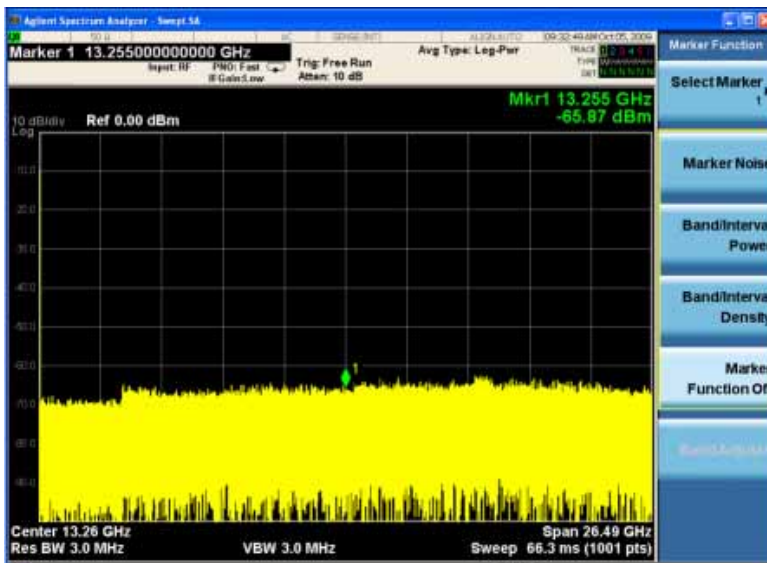

Some of the menu keys are grouped together by a yellow bar running behind the keys near the left side or by a yellow border around the group of keys. When you press a key within the yellow region, such as **Marker Noise**, the highlight moves to that key to show it has been selected. The keys that are linked are related functions, and only one of them can be selected at any one time. For example, a marker can only have one marker function active on it. So if you select a different function it turns off the previous selection. If the current menu is two pages long, the yellow bar or border could include keys on the second page of keys.

In some key menus, a key label is highlighted to show which key has been selected from multiple available choices. And the menu is immediately exited when you press one of the other keys. For example, when you press the **Select Trace** key (in the **Trace/Detector** menu), it brings up its own menu of keys. The **Trace 1** key is highlighted. When you press the **Trace 2** key, the highlight moves to that key and the screen returns to the **Trace/Detector** menu.

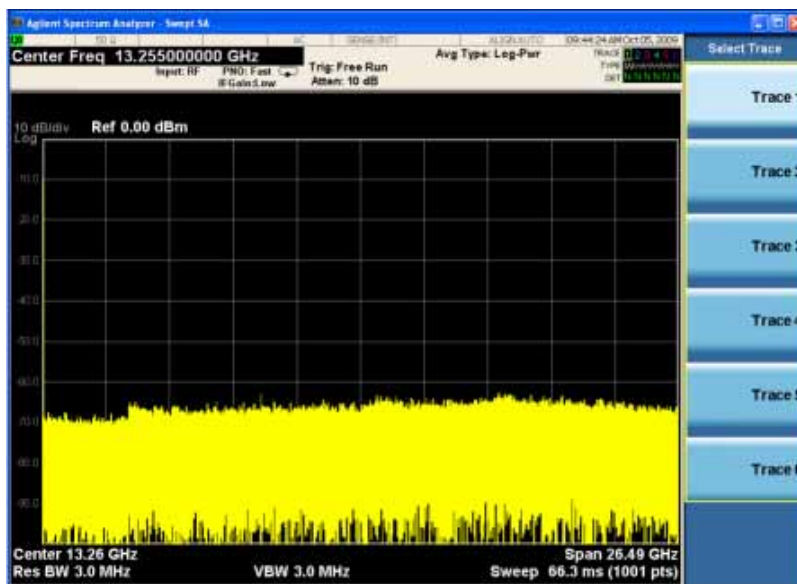

About the Analyzer Front-Panel Features

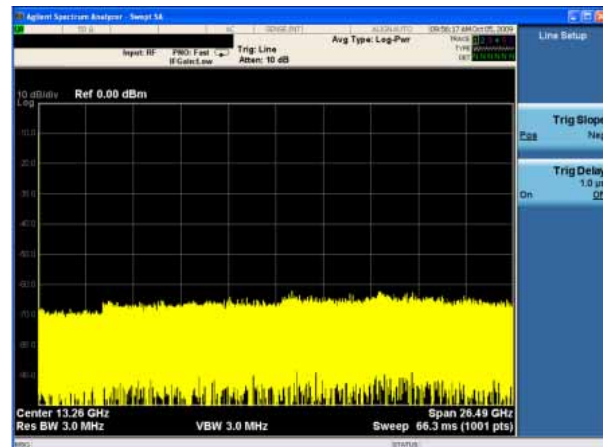
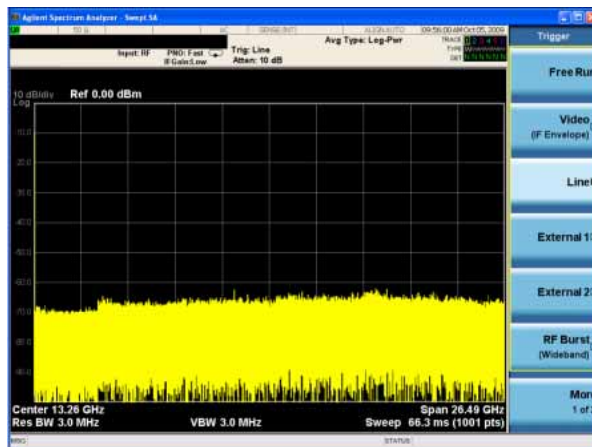
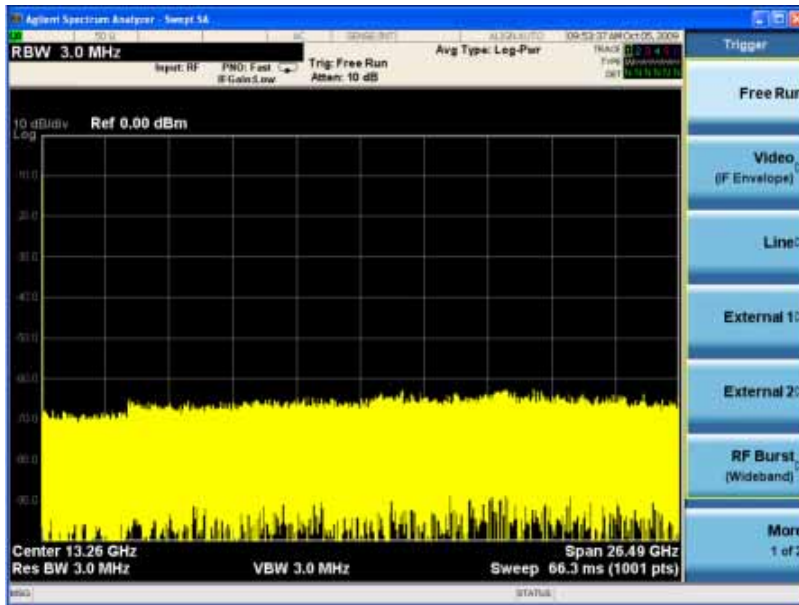

If a displayed key label shows a small solid-black arrow tip pointing to the right, it indicates that additional key menus are available. If the arrow tip is not filled in solid then pressing the key the first time selects that function. Now the arrow is solid and pressing it again brings up an additional menu of settings.

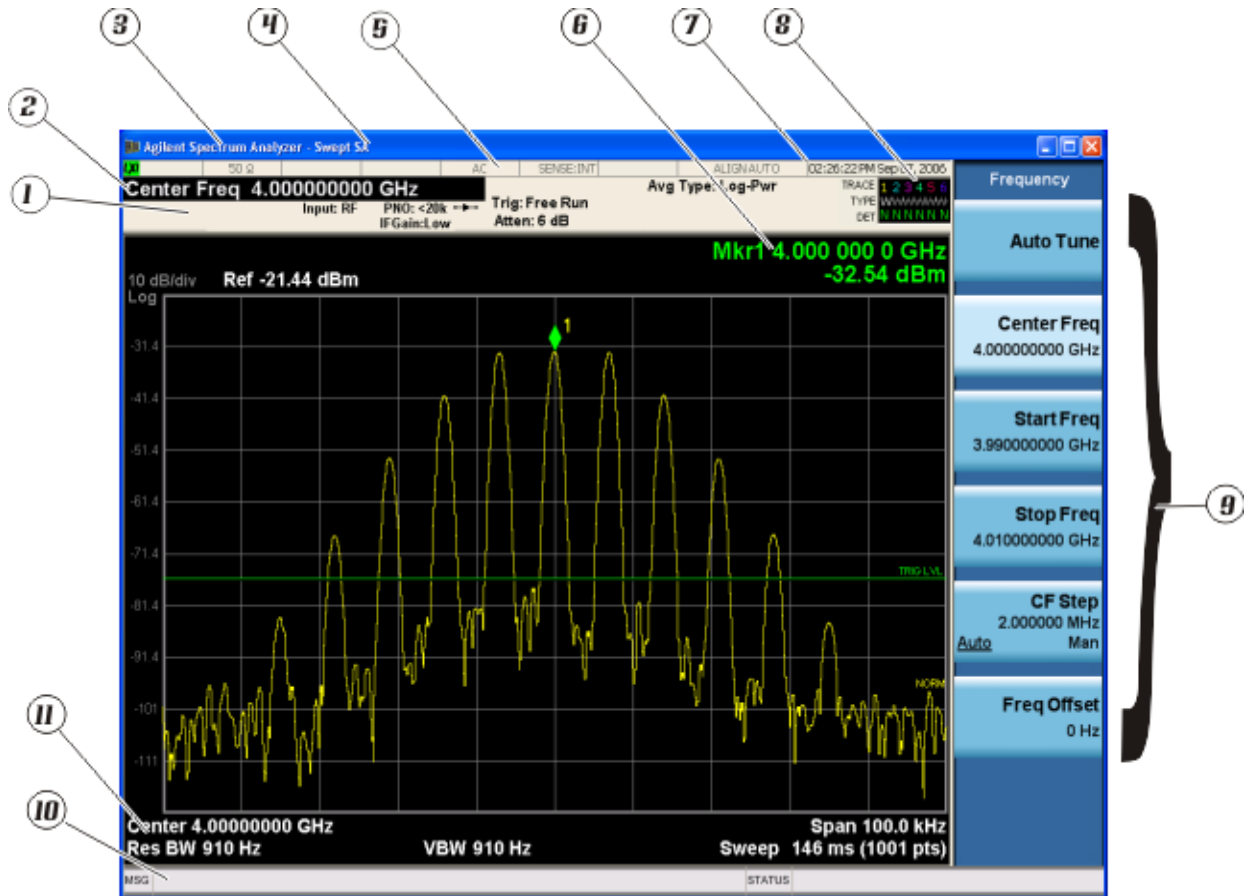

Display Annotations

This section describes the display annotation as it is on the Spectrum Analyzer Measurement Application display. Other measurement application modes have some annotation differences.



Item	Description	Function Keys
1	Measurement bar - Shows general measurement settings and information.   Indicates single/continuous measurement. Some measurements include limits that the data is tested against. A Pass/Fail indication may be shown in the lower left of the measurement bar.	All the keys in the Analyzer Setup part of the front panel.
2	Active Function (measurement bar) - when the current active function has a settable numeric value, it is shown here.	Currently selected front panel key.
3	Banner - shows the name of the selected application that is currently running.	Mode
4	Measurement title - shows title information for the current measurement, or a title that you created for the measurement.	Meas View/Display, Display, Title

About the Analyzer
Display Annotations

Item	Description	Function Keys
5	Settings panel - displays system information that is not specific to any one application. <ul style="list-style-type: none"> • Input/Output status - green LXI indicates the LAN is connected. RLTS indicate Remote, Listen, Talk, SRQ • Input impedance and coupling • Selection of external frequency reference • Setting of automatic internal alignment routine 	Local and System, I/O Config Input/Output, Amplitude, System and others
6	Active marker frequency, amplitude or function value	Marker
7	Settings panel - time and date display.	System, Control Panel
8	Trace and detector information	Trace/Detector, Clear Write (W) Trace Average (A) Max Hold (M) Min Hold (m) Trace/Detector, More, Detector, Average (A) Normal (N) Peak (P) Sample (S) Negative Peak (p)
9	Key labels that change based on the most recent key press.	Softkeys
10	Displays information, warning and error messages. Message area - single events, Status area - conditions	
11	Measurement settings for the data currently being displayed in the graticule area. In the example above: center frequency, resolution bandwidth, video bandwidth, frequency span, sweep time and number of sweep points.	Keys in the Analyzer Setup part of the front panel.

Rear-Panel Features

PXA, MXA and EXA with Option PC2



EXA

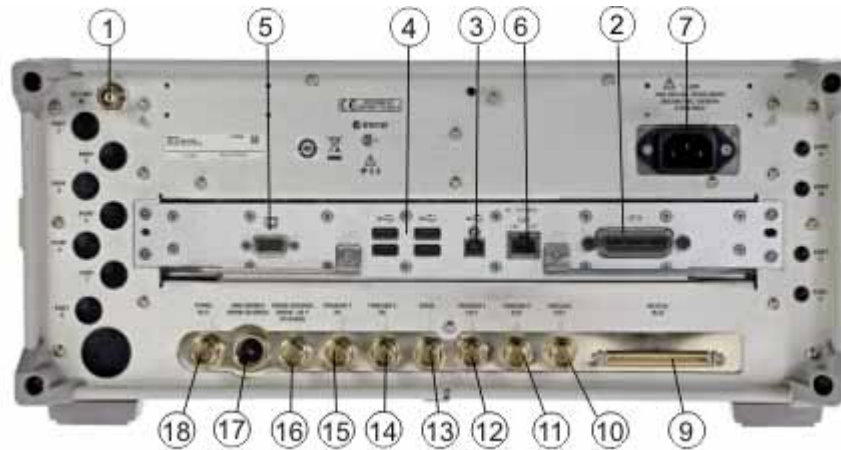

CXA

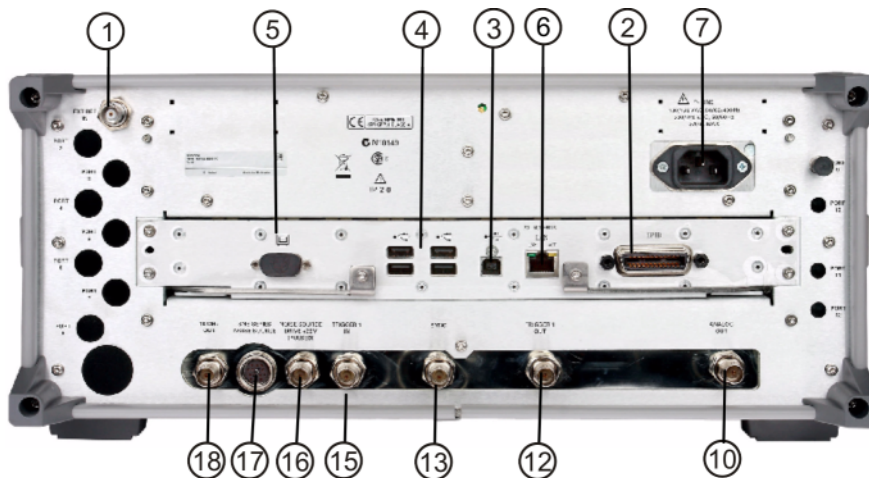

About the Analyzer
Rear-Panel Features

Item		Description
#	Name	
1	EXT REF IN	Input for an external frequency reference signal: For PXA – 1 to 50 MHz For MXA – 1 to 50 MHz For EXA – 10 MHz. For CXA – 10 MHz.
2	GPIB	A General Purpose Interface Bus (GPIB, IEEE 488.1) connection that can be used for remote analyzer operation.
3	USB Connector	USB 2.0 port, Type B. USB TMC (test and measurement class) connects to an external pc controller to control the instrument and for data transfers over a 480 Mbps link.
4	USB Connectors	Standard USB 2.0 ports, Type A. Connect to external peripherals such as a mouse, keyboard, printer, DVD drive, or hard drive.
5	MONITOR	Allows connection of an external VGA monitor.
6	LAN	A TCP/IP Interface that is used for remote analyzer operation.
7	Line power input	The AC power connection. See the product specifications for more details.
8	Removable Disk Drive	Standard on PXA and MXA. Optional on EXA.
9	Digital Bus	Reserved for future use.
10	Analog Out	For PXA option YAV: Screen Video Log Video Linear Video For PXA option EMC: Demod Audio
11	TRIGGER 2 OUT	A trigger output used to synchronize other test equipment with the analyzer. Configurable from the Input/Output keys.
12	TRIGGER 1 OUT	A trigger output used to synchronize other test equipment with the analyzer. Configurable from the Input/Output keys.
13	Sync	Reserved for future use.
14	TRIGGER 2 IN	Allows external triggering of measurements.
15	TRIGGER 1 IN	Allows external triggering of measurements.
16	Noise Source Drive +28 V (Pulsed)	For use with Agilent 346A, 346B, and 346C Noise Sources.

Item		Description
#	Name	
17	SNS Series Noise Source	For use with Agilent N4000A, N4001A, N4002A Smart Noise Sources (SNS).
18	10 MHz OUT	An output of the analyzer internal 10 MHz frequency reference signal. It is used to lock the frequency reference of other test equipment to the analyzer.
19	Preselector Tune Out	Reserved for future use.
20	Aux IF Out	For PXA options: CR3 Second IF Out CRP Arbitrary IF Out ALV Log Video

Window Control Keys

The instrument provides three front-panel keys for controlling windows. They are **Multi Window**, **Zoom**, and **Next Window**. These are all “immediate action” keys.

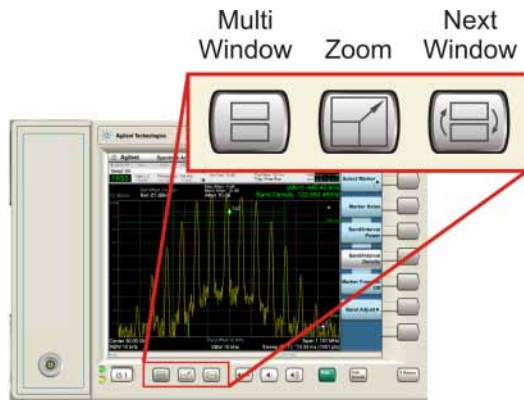

Multi-Window

The **Multi Window** front-panel key is not used at this time. It is there to support future functionality.

Key Path	Front-panel key
Initial S/W Revision	Prior to A.02.00

Zoom

Zoom is a toggle function. Pressing once Zooms the selected window; pressing again un-zooms.

When Zoom is on for a window, that window will get the entire primary display area. The zoomed window, since it is the selected window, is outlined in green.

Zoom is local to each Measurement. Each Measurement remembers its Zoom state. The Zoom state of each Measurement is part of the Mode’s state.

NOTE Data acquisition and processing for the other windows continues while a window is zoomed, as does all SCPI communication with the other windows.

Remote Command	:DISPlay:WINDow:FORMat:ZOOM
Remote Command	:DISPlay:WINDow:FORMat:TILE
Example	:DISP:WIND:FORM:ZOOM sets zoomed :DISP:WIND:FORM:TILE sets un-zoomed

Preset	TILE
Initial S/W Revision	Prior to A.02.00

Next Window

Selects the next window of the current view.

When this key is selected in Help Mode, it toggles focus between the table of contents window and the topic pane window.

Remote Command	:DISPlay:WINDow[:SElect] <number> :DISPlay:WINDow[:SElect] ?
Example	:DISP:WIND 1
Preset	1
Min	1
Max	If <number> is greater than the number of windows, limit to <number of windows>
Initial S/W Revision	Prior to A.02.00

Selected Window

One and only one window is always selected. The selected window has the focus and all key presses are going to that window.

The selected window has a green boundary. If a window is not selected, its boundary is gray.

If a window in a multi-window display is zoomed it is still outlined in green. If there is only one window, the green outline is not used. This allows the user to distinguish between a zoomed window and a display with only one window.

The selected window is local to each Measurement. Each Measurement remembers which window is selected. The selected window for each Measurement is remembered in Mode state.

Navigating Windows

When the Next Window key is pressed, the next window in the order of precedence becomes selected. If the selected window was zoomed, the next window will also be zoomed.

The window navigation does NOT use the arrow and select keys. Those are reserved for navigation within a window.

Mouse and Keyboard Control

If you do not have access to the instrument front-panel, there are several ways that a mouse and PC Keyboard can give you access to functions normally accessed using the front-panel keys.

Right-Click

If you plug in a mouse and right-click on the analyzer screen, a menu will appear as below:

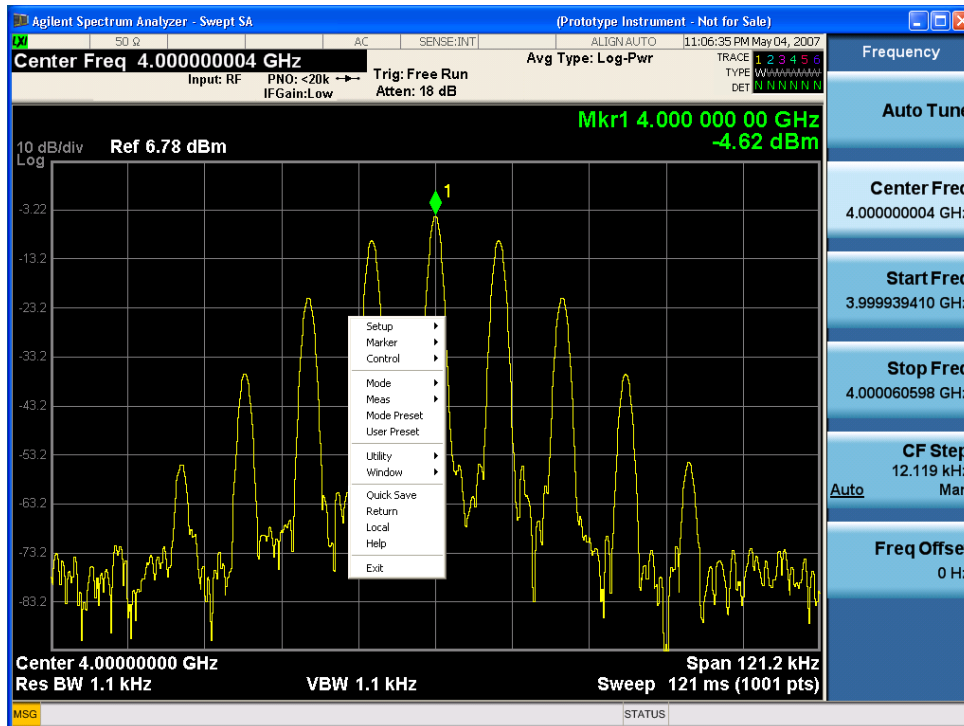

Placing the mouse on one of the rows marked with a right arrow symbol will cause that row to expand, as for example below where the mouse is hovered over the “Utility” row:

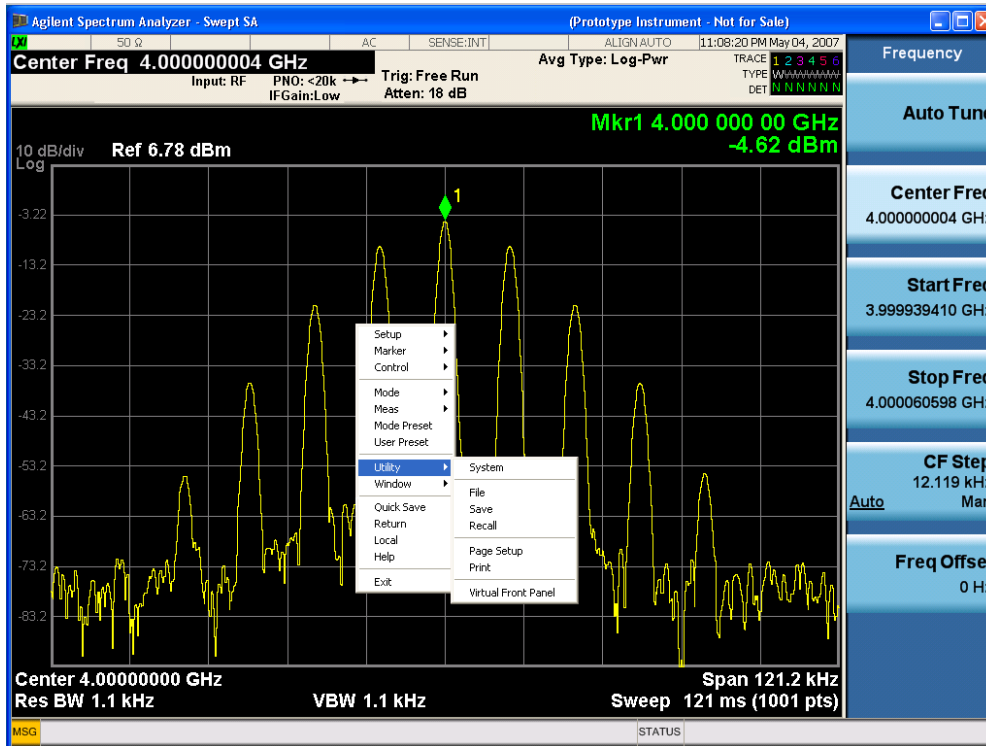

This method can be used to access any of the front-panel keys by using a mouse; as for example if you are accessing the instrument through Remote Desktop.

The array of keys thus available is shown below:

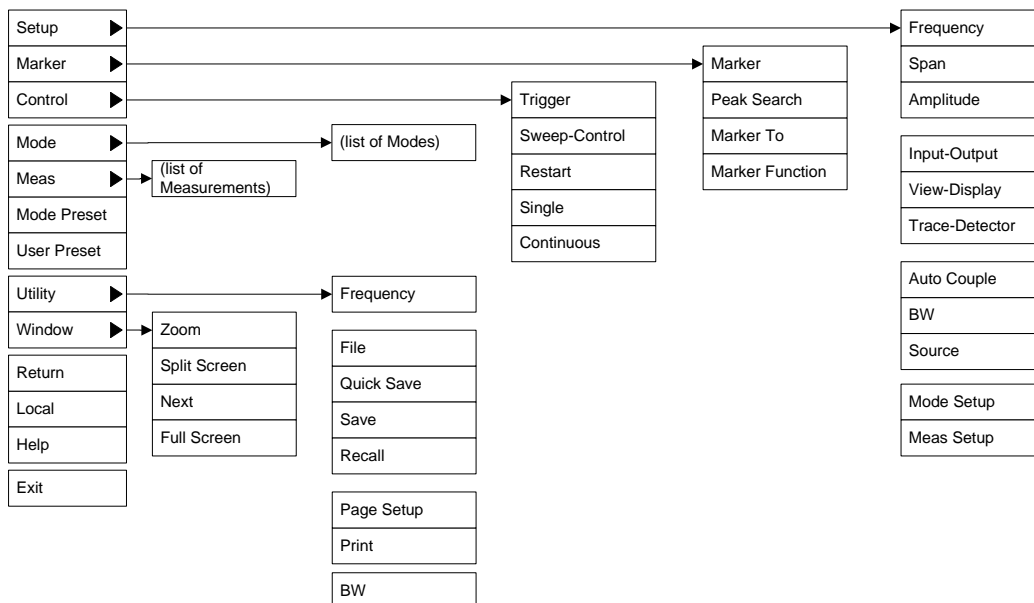

PC Keyboard

If you have a PC keyboard plugged in (or via Remote Desktop), certain key codes on the PC keyboard

About the Analyzer
Mouse and Keyboard Control

map to front-panel keys on the GPSA front panel. These key codes are shown below:

Front-panel key	Key code
Frequency	CTRL+SHIFT+F
Span	CTRL+SHIFT+S
Amplitude	CTRL+SHIFT+A
Input/Output	CTRL+SHIFT+O
View/Display	CTRL+SHIFT+V
Trace/Detector	CTRL+ALT+T
Auto Couple	CTRL+SHIFT+C
Bandwidth	CTRL+ALT+B
Source	CTRL+SHIFT+E
Marker	CTRL+ALT+K
Peak Search	CTRL+ALT+P
Marker To	CTRL+ALT+N
Marker Function	CTRL+ALT+F
System	CTRL+SHIFT+Y
Quick Save	CTRL+Q
Save	CTRL+S
Recall	CTRL+R
Mode Preset	CTRL+M
User Preset	CTRL+U
Print	CTRL+P
File	CTRL+SHIFT+L
Mode	CTRL+SHIFT+M
Measure	CTRL+ALT+M
Mode Setup	CTRL+SHIFT+E
Meas Setup	CTRL+ALT+E
Trigger	CTRL+SHIFT+T
Sweep/Control	CTRL+SHIFT+W
Restart	CTRL+ALT+R
Single	CTRL+ALT+S

Front-panel key	Key code
Cont	CTRL+ALT+C
Zoom	CTRL+SHIFT+Z
Next Window	CTRL+SHIFT+N
Split Screen	CTRL+L
Full Screen	CTRL+SHIFT+B
Return	CTRL+SHIFT+R
Mute	Mute
Inc Audio	Volume Up
Dec Audio	Volume Down
Help	F1
Control	CTRL
Alt	ALT
Enter	Return
Cancel	Esc
Del	Delete
Backspace	Backspace
Select	Space
Up Arrow	Up
Down Arrow	Down
Left Arrow	Left
Right Arrow	Right
Menu key 1	CTRL+SHIFT+F1
Menu key 2	CTRL+SHIFT+F2
Menu key 3	CTRL+SHIFT+F3
Menu key 4	CTRL+SHIFT+F4
Menu key 5	CTRL+SHIFT+F5
Menu key 6	CTRL+SHIFT+F6
Menu key 7	CTRL+SHIFT+F7
Backspace	BACKSPACE
Enter	ENTER

About the Analyzer
Mouse and Keyboard Control

Front-panel key	Key code
Tab	Tab
1	1
2	2
3	3
4	4
5	5
6	6
7	7
8	8
9	9
0	0

This is a pictorial view of the table:

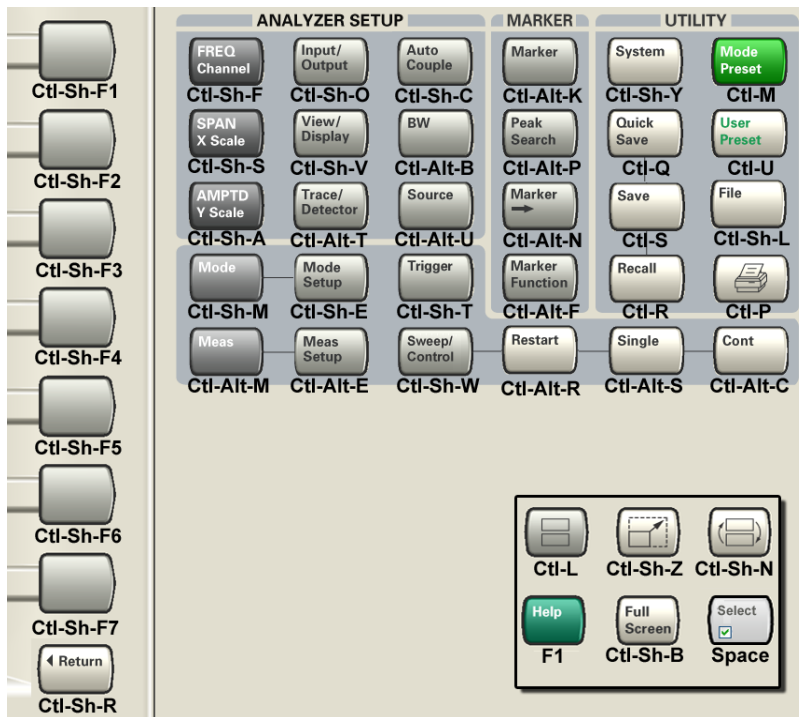

Instrument Security & Memory Volatility

If you are using the instrument in a secure environment, you may need details of how to clear or sanitize its memory, in compliance with published security standards of the United States Department of Defense, or other similar authorities.

For the X Series analyzers, this information is contained in the document "Security Features and Certificate of Volatility". This document is **not** included in the Documentation CD, or the instrument's on-disk library, but it may be downloaded from Agilent's web site.

To obtain a copy of the document, click on or browse to the following URL:

<http://www.agilent.com/find/security>

To locate and download the document, select Model Number "N9020A", then click "Submit". Then, follow the on-screen instructions to download the file.

About the N6158A CMMB Measurement Application

This chapter provides the overall information on N6158A CMMB measurement application. CMMB measurement application supports CMMB standard measurements.

CMMB (China Multimedia Mobile Broadcasting) is a mobile digital video standard developed in China, and was implemented on November 1, 2006.

What Does the CMMB Measurement Application Do?

The CMMB measurement application allows the signal analyzer to be used for testing a CMMB transmitter and exciter.

This application is manufactured according to the following documents:

- GY/T 220.1-2006 Mobile Multimedia Broadcasting Part 1: Framing Structure, Channel Coding and Modulation for Broadcasting Channel
- GD/J020-2008 Technical Specifications and Methods of Measurement for Mobile Multimedia Broadcasting Transmitters
- Technical Specifications and Methods of Measurement for Mobile Multimedia Broadcasting Exciters (draft)

These documents define complex, multi-part measurements to create an interference-free environment and to ensure high quality transmission. For example, the documents standardize the test methods for transmitting power, shoulder attenuation, acp, spectrum emission mask, MER, and other critical measurements.

The analyzer automatically makes these measurements according to the methods defined in the documents. The detailed measurement results displayed enable you to analyze the CMMB transmitter/exciter's performance. You can also alter the measurement parameters for specialized analysis.

The N6158A CMMB measurement application provides the following measurements of CMMB signals:

- Channel Power
- ACP
- Power Stat CCDF
- Spectrum Emission Mask
- Mod Accuracy
- Occupied BW
- Monitor Spectrum
- IQ Waveform

If the option BBA is installed, you can analyze baseband I/Q signal characteristics of CMMB signals. The baseband I/Q analysis is available in the following measurements:

- Power Stat CCDF
- Modulation Accuracy
- IQ Waveform

This chapter provides introductory information about the programming documentation included with your product.

What Programming Information is Available?

The X-Series Documentation can be accessed through the Additional Documentation page in the instrument Help system and is included on the Documentation CD shipped with the instrument. It can also be found in the instrument at: C:\ProgramsFiles\Agilent\SignalAnalysis\Infrastructure\Help\otherdocs, or online at: http://www.agilent.com/find/mxa_manuals.

The following resources are available to help you create programs for automating your X-Series measurements:

Resource	Description
X-Series Programmer's Guide	<p>Provides general SCPI programming information on the following topics:</p> <ul style="list-style-type: none"> • Programming the X-Series Applications • Programming fundamentals • Programming examples <p>Note that SCPI command descriptions for measurement applications are NOT in this book, but are in the User's and Programmer's Reference.</p>
User's and Programmer's Reference manuals	<p>Describes all front-panel keys and softkeys, including SCPI commands for a measurement application. Note that:</p> <ul style="list-style-type: none"> • Each measurement application has its own User's and Programmer's Reference. • The content in this manual is duplicated in the analyzer's Help (the Help that you see for a key is identical to what you see in this manual).
Embedded Help in your instrument	<p>Describes all front-panel keys and softkeys, including SCPI commands, for a measurement application.</p> <p>Note that the content that you see in Help when you press a key is identical to what you see in the User's and Programmer's Reference.</p>
X-Series Getting Started Guide	<p>Provides valuable sections related to programming including:</p> <ul style="list-style-type: none"> • Licensing New Measurement Application Software - After Initial Purchase • Configuring instrument LAN Hostname, IP Address, and Gateway Address • Using the Windows XP Remote Desktop to connect to the instrument remotely • Using the Embedded Web Server Telnet connection to communicate SCPI <p>This printed document is shipped with the instrument.</p>
Agilent Application Notes	Printable PDF versions of pertinent application notes.
Agilent VISA User's Guide	Describes the Agilent Virtual Instrument Software Architecture (VISA) library and shows how to use it to develop I/O applications and instrument drivers on Windows PCs.

IEEE Common GPIB Commands

Numeric values for bit patterns can be entered using decimal or hexi-decimal representations. (that is, 0 to 32767 is equivalent to #H0 to #H7FFF).

Calibration Query

*CAL? Performs a full alignment and returns a number indicating the success of the alignment. A zero is returned if the alignment is successful. A one is returned if any part of the alignment fails. The equivalent SCPI command is CALibrate[:ALL]?

See “Alignments” on page 207 for details of *CAL?.

Clear Status

Clears the status byte register. It does this by emptying the error queue and clearing all bits in all of the event registers. The status byte register summarizes the states of the other registers. It is also responsible for generating service requests.

Key Path	No equivalent key. Related key System, Show Errors, Clear Error Queue
Remote Command	*CLS
Example	*CLS Clears the error queue and the Status Byte Register.
Notes	For related commands, see the SYSTem:ERRor[:NEXT]? command. See also the STATus:PRESet command and all commands in the STATus subsystem.
Status Bits/OPC dependencies	Resets all bits in all event registers to 0, which resets all the status byte register bits to 0 also.
Initial S/W Revision	Prior to A.02.00

Standard Event Status Enable

Selects the desired bits from the standard event status enable register. This register monitors I/O errors and synchronization conditions such as operation complete, request control, query error, device dependent error, status execution error, command error, and power on. The selected bits are OR'd to become a summary bit (bit 5) in the byte register which can be queried.

The query returns the state of the standard event status enable register.

Key Path	No equivalent key. Related key System, Show Errors, Clear Error Queue
Remote Command	*ESE <integer> *ESE?

Example	*ESE 36 Enables the Standard Event Status Register to monitor query and command errors (bits 2 and 5). *ESE? Returns a 36 indicating that the query and command status bits are enabled.
Notes	For related commands, see the STATus subsystem and SYSTem:ERRor[:NEXT]? commands.
Preset	255
State Saved	Not saved in state.
Min	0
Max	255
Status Bits/OPC dependencies	Event Enable Register of the Standard Event Status Register.
Initial S/W Revision	Prior to A.02.00

Standard Event Status Register Query

Queries and clears the standard event status event register. (This is a destructive read.) The value returned is a hexadecimal number that reflects the current state (0/1) of all the bits in the register.

Remote Command	*ESR?
Example	*ESR? Returns a 1 if there is either a query or command error, otherwise it returns a zero.
Notes	For related commands, see the STATus subsystem commands.
Preset	0
Min	0
Max	255
Status Bits/OPC dependencies	Standard Event Status Register (bits 0 – 7).
Initial S/W Revision	Prior to A.02.00

Identification Query

Returns a string of instrument identification information. The string will contain the model number, serial number, and firmware revision.

The response is organized into four fields separated by commas. The field definitions are as follows:

- Manufacturer
- Model
- Serial number

- Firmware version

Key Path	No equivalent key. See related key System, Show System.
Remote Command	*IDN?
Example	*IDN? Returns instrument identification information, such as: Agilent Technologies,N9020A,US01020004,A.01.02
Initial S/W Revision	Prior to A.02.00

Instrument Model Number

ID? - Returns a string of the instrument identification. The string will contain the model number.

When in Remote Language compatibility mode the query will return the model number of the emulated instrument, when in any other mode the returned model number will be that of the actual hardware.

Operation Complete

The *OPC command sets bit 0 in the standard event status register (SER) to “1” when pending operations have finished, that is when all overlapped commands are complete. It does not hold off subsequent operations. You can determine when the overlapped commands have completed either by polling the OPC bit in SER, or by setting up the status system such that a service request (SRQ) is asserted when the OPC bit is set.

The *OPC? query returns a “1” after all the current overlapped commands are complete. So it holds off subsequent commands until the "1" is returned, then the program continues. This query can be used to synchronize events of other instruments on the external bus.

Remote Command	*OPC *OPC?
Example	INIT:CONT 0 Selects single sweeping. INIT:IMM Initiates a sweep. *OPC? Holds off any further commands until the sweep is complete.
Status Bits/OPC dependencies	Not global to all remote ports or front panel. *OPC only considers operation that was initiated on the same port as the *OPC command was issued from. *OPC is an overlapped command, but *OPC? is sequential.
Initial S/W Revision	Prior to A.02.00

Query Instrument Options

Returns a string of all the installed instrument options. It is a comma separated list with quotes, such as: “503,P03,PFR”.

To be IEEE compliant, this command should return an arbitrary ascii variable that would not begin and end with quotes. But the quotes are needed to be backward compatible with previous SA products and

software. So, the actual implementation will use arbitrary ascii. But quotes will be sent as the first and last ascii characters that are sent with the comma-separated option list.

Remote Command	*OPT?
Initial S/W Revision	Prior to A.02.00

Recall Instrument State

This command recalls the instrument state from the specified instrument memory register.

- If the state being loaded has a newer firmware revision than the revision of the instrument, no state is recalled and an error is reported.
- If the state being loaded has an equal firmware revision than the revision of the instrument, the state will be loaded.
- If the state being loaded has an older firmware revision than the revision of the instrument, the instrument will only load the parts of the state that apply to the older revision.

Remote Command	*RCL <register #>
Example	*RCL 7 Recalls the instrument state that is currently stored in register 7.
Notes	Registers 0 through 6 are accessible from the front panel in menu keys for Recall Registers.
Min	0
Max	127
Status Bits/OPC dependencies	The command is sequential.
Initial S/W Revision	Prior to A.02.00

Save Instrument State

This command saves the current instrument state and mode to the specified instrument memory register.

Remote Command	*SAV <register #>
Example	*SAV 9 Saves the instrument state in register 9.
Notes	Registers 0 through 6 are accessible from the front panel in menu keys for Save Registers.
Min	0
Max	127
Status Bits/OPC dependencies	The command is sequential.
Initial S/W Revision	Prior to A.02.00

Service Request Enable

This command enables the desired bits of the service request enable register.

The query returns the value of the register, indicating which bits are currently enabled.

Remote Command	*SRE <integer> *SRE?
Example	*SRE 22 Enables bits 1, 2, and 4 in the service request enable register.
Notes	For related commands, see the STATus subsystem and SYSTem:ERRor[:NEXT]? commands.
Preset	0
Min	0
Max	255
Status Bits/OPC dependencies	Service Request Enable Register (all bits, 0 – 7).
Initial S/W Revision	Prior to A.02.00

Status Byte Query

Returns the value of the status byte register without erasing its contents.

Remote Command	*STB?
Example	*STB? Returns a decimal value for the bits in the status byte register. For example, if a 16 is returned, it indicates that bit 5 is set and one of the conditions monitored in the standard event status register is set.
Notes	See related command *CLS.
Status Bits/OPC dependencies	Status Byte Register (all bits, 0 – 7).
Initial S/W Revision	Prior to A.02.00

Trigger

This command triggers the instrument. Use the :TRIGger[:SEQuence]:SOURce command to select the trigger source.

Key Path	No equivalent key. See related keys Single and Restart.
Remote Command	*TRG
Example	*TRG Triggers the instrument to take a sweep or start a measurement, depending on the current instrument settings.
Notes	See related command :INITiate:IMMediate.
Initial S/W Revision	Prior to A.02.00

Self Test Query

This query performs the internal self-test routines and returns a number indicating the success of the testing. A zero is returned if the test is successful, 1 if it fails.

Remote Command	*TST?
Example	*TST? Runs the self-test routines and returns 0=passed, 1=some part failed.
Initial S/W Revision	Prior to A.02.00

Wait-to-Continue

This command causes the instrument to wait until all overlapped commands are completed before executing any additional commands. There is no query form for the command.

Remote Command	*WAI
Example	INIT:CONT OFF; INIT;*WAI Sets the instrument to single sweep. Starts a sweep and waits for its completion.
Status Bits/OPC dependencies	Not global to all remote ports or front panel. *OPC only considers operation that was initiated on the same port as the *OPC command was issued from.
Initial S/W Revision	Prior to A.02.00

File

Opens a menu that enables you to access various standard and custom Windows functions. Press any other front-panel key to exit

Key Path	Front-panel key
Initial S/W Revision	Prior to A.02.00

File Explorer

Opens the standard Windows File Explorer. The File Explorer opens in the My Documents directory for the current user.

The File Explorer is a separate Windows application, so to return to the analyzer once you are in the File Explorer, you may either:

Exit the File Explorer by clicking on the red X in the upper right hand corner, with a mouse

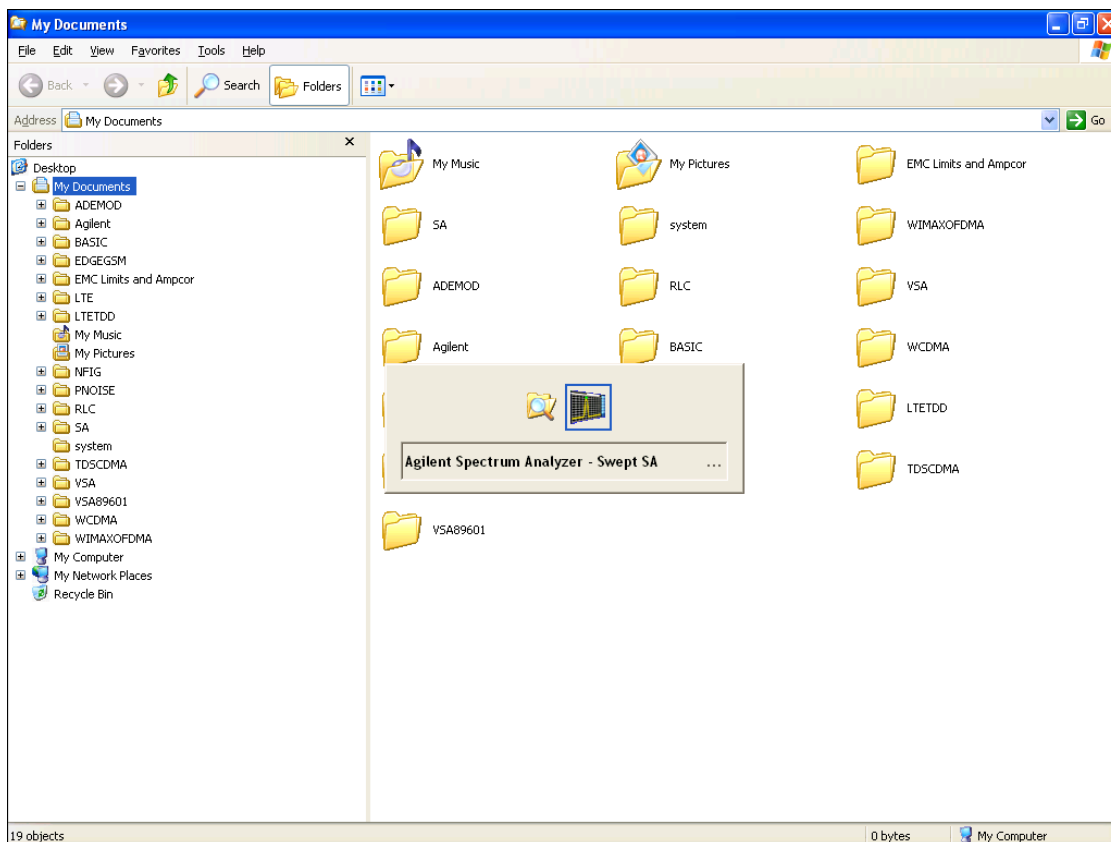

Or use Alt-Tab: press and hold the Alt  key and press and release the Tab key until the Analyzer

logo is showing in the window in the center of the screen, as above, then release the Alt key.

Key Path	File
Initial S/W Revision	Prior to A.02.00

Page Setup

The Page Setup key brings up a Windows Page Setup dialog that allows you to control aspects of the pages sent to the printer when the PRINT hardkey is pressed.

Key Path	File
Initial S/W Revision	Prior to A.02.00

Paper size, the printer paper source, the page orientation and the margins are all settable. Just like any standard Windows dialog, you may navigate the dialog using front-panel keys, or a mouse. There are no SCPI commands for controlling these parameters.

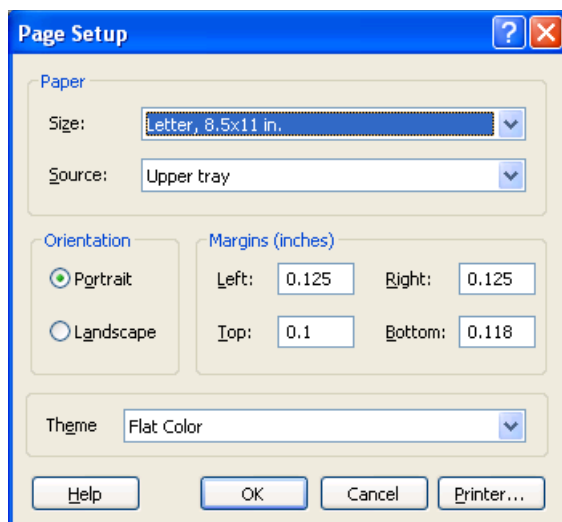

Also contained in this dialog is a drop-down control that lets you select the Theme to use when printing. For more on Themes, see information under View/Display, Display, System Display Settings, Theme. The Theme control has a corresponding SCPI command:

Parameter Name	Print Themes
Parameter Type	Enum
Mode	All
Remote Command	:SYSTem:PRINT:THEME TDCOLOR TDMONochrome FCOLOR FMONochrome :SYSTem:PRINT:THEME?
Example	:SYST:PRIN:THEM FCOL

System Functions

File

Setup	: SYSTem:DEFault MISC
Preset	FCOL; not part of Preset, but is reset by Restore Misc Defaults or Restore System Defaults All and survives subsequent running of the modes.
State Saved	No
Initial S/W Revision	Prior to A.02.00

Print

Refer to your Microsoft Windows Operating System manual.

Exit

This key, when pressed, will exit the Instrument Application. A dialog box is used to confirm that you intended to exit the application:

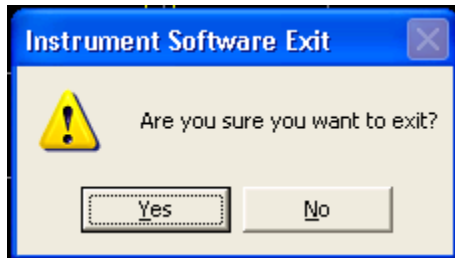

Key Path	File
Mode	All
Notes	The Instrument Application will close. No further SCPI commands can be sent. Use with caution!
Initial S/W Revision	Prior to A.02.00

Preset

Mode Preset

Returns the active mode to a known state.

Mode Preset does the following for the currently active mode:

- Aborts the currently running measurement.
- Brings up the default menu for the mode, with no active function.
- Sets measurement Global settings to their preset values for the active mode only.
- Activates the default measurement.
- Brings up the default menu for the mode.
- Clears the input and output buffers.
- Sets Status Byte to 0.

Mode Preset does not:

- Cause a mode switch
- Affect mode persistent settings
- Affect system settings

See “[How-To Preset](#)” on page 147 for more information.

Key Path	Front-panel key
Remote Command	:SYSTem:PRESet
Example	:SYST:PRES
Notes	*RST is preferred over :SYST:PRES for remote operation. *RST does a Mode Preset, as done by the :SYST:PRES command, and sets the measurement mode to Single measurement rather than Continuous for optimal remote control throughput. Clears all pending OPC bits. The Status Byte is set to 0.
Couplings	A Mode Preset aborts the currently running measurement, activates the default measurement, and gets the mode to a consistent state with all of the default couplings set.
Initial S/W Revision	Prior to A.02.00

How-To Preset

The table below shows all possible presets, their corresponding SCPI commands and front-panel access (key paths). Instrument settings depend on the current measurement context. Some settings are local to the current measurement, some are global (common) across all the measurements in the current mode,

System Functions

Preset

and some are global to all the available modes. In a similar way, restoring the settings to their preset state can be done within the different contexts.

Auto Couple - is a measurement local key. It sets all Auto/Man parameter couplings in the measurement to Auto. Any Auto/Man selection that is local to other measurements in the mode will not be affected.

Meas Preset - is a measurement local key. Meas Preset resets all the variables local to the current measurement except the persistent ones.

Mode Preset - resets all the current mode's measurement local and measurement global variables except the persistent ones.

Restore Mode Defaults - resets ALL the Mode variables (and all the Meas global and Meas local variables), including the persistent ones.

Type Of Preset	SCPI Command	Front Panel Access
Auto Couple	:COUPLe ALL	Auto Couple front-panel key
Meas Preset	:CONFIgure:<Measurement>	Meas Setup Menu
Mode Preset	:SYSTem:PRESet	Mode Preset (green key)
Restore Mode Defaults	:INSTrument:DEFault	Mode Setup Menu
Restore All Mode Defaults	:SYSTem:DEFault MODEs	System Menu; Restore System Default Menu
*RST	*RST	not possible (Mode Preset with Single)
Restore Input/Output Defaults	:SYSTem:DEFault INPut	System Menu; Restore System Default Menu
Restore Power On Defaults	:SYSTem:DEFault PON	System Menu; Restore System Default Menu
Restore Alignment Defaults	:SYSTem:DEFault ALIGN	System Menu; Restore System Default Menu
Restore Miscellaneous Defaults	:SYSTem:DEFault MISC	System Menu; Restore System Default Menu
Restore All System Defaults	:SYSTem:DEFault [ALL] :SYSTem:PRESet:PERsistent	System Menu; Restore System Default Menu
User Preset	:SYSTem:PRESet:USER	User Preset Menu
User Preset All Modes	:SYSTem:PRESet:USER:ALL	User Preset Menu
Power On Mode Preset	:SYSTem:PON:TYPE MODE	System Menu
Power On User Preset	:SYSTem:PON:TYPE USER	System Menu
Power On Last State	:SYSTem:PON:TYPE LAST	System Menu

Restore Mode Defaults

Resets the state for the currently active mode by resetting the mode persistent settings to their factory default values, clearing mode data and by performing a Mode Preset. This function will never cause a mode switch. This function performs a full preset for the currently active mode; whereas, Mode Preset performs a partial preset. Restore Mode Defaults does not affect any system settings. System settings are reset by the Restore System Defaults function. This function does reset mode data; as well as settings.

Key Path	Mode Setup
Remote Command	:INSTrument:DEFault
Example	:INST:DEF
Notes	Clears all pending OPC bits. The Status Byte is set to 0. A message comes up saying: "If you are sure, press key again".
Couplings	A Restore Mode Defaults will cause the currently running measurement to be aborted and causes the default measurement to be active. It gets the mode to a consistent state with all of the default couplings set.
Initial S/W Revision	Prior to A.02.00

*RST (Remote Command Only)

*RST is equivalent to :SYST:PRES;:INIT:CONT OFF which is a Mode Preset in the Single measurement state. This remote command is preferred over Mode Preset remote command - :SYST:PRES, as optimal remote programming occurs with the instrument in the single measurement state.

Remote Command	*RST
Example	*RST
Notes	Sequential Clears all pending OPC bits and the Status Byte is set to 0.
Couplings	A *RST will cause the currently running measurement to be aborted and cause the default measurement to be active. *RST gets the mode to a consistent state with all of the default couplings set.
Initial S/W Revision	Prior to A.02.00

Print

This front-panel key is equivalent to performing a File, Print, OK. It immediately performs the currently configured Print to the Default printer.

The :HCOPY command is equivalent to pressing the PRINT key. The HCOPY:ABORt command can be used to abort a print which is already in progress. Sending HCOPY:ABORt will cause the analyzer to stop sending data to the printer, although the printer may continue or even complete the print, depending on how much data was sent to the printer before the user sent the ABORt command.

Key Path	Front-panel key
Remote Command	:HCOPY[:IMMEDIATE]
Initial S/W Revision	Prior to A.02.00

Key Path	SCPI command only
Remote Command	:HCOPY:ABORt
Initial S/W Revision	Prior to A.02.00

Quick Save

The Quick Save front-panel key repeats the most recent save that was performed from the Save menu, with the following exceptions: :

Register saves are not remembered as Saves for the purpose of the Quick Save function

If the current measurement does not support the last non-register save that was performed, an informational message is generated, “File type not supported for this measurement”

Quick Save repeats the last type of qualified save (that is, a save qualified by the above criteria) in the last save directory by creating a unique filename using the Auto File Naming algorithm described below.

If Quick Save is pressed after startup and before any qualified Save has been performed, the Quick Save function performs a Screen Image save using the current settings for Screen Image saves (current theme, current directory), which then becomes the “last save” for the purpose of subsequent Quick Saves.

The Auto File Naming feature automatically generates a file name for use when saving a file. The filename consists of a prefix and suffix separated by a dot, as is standard for the Windows® file system. A default prefix exists for each of the available file types:

Type	Default Prefix	Menu
State	State_	(Save/Recall)
Trace + State	State_	(Save/Recall)
Screen	Screen_	(Save/Recall)
Amplitude Corrections	Ampcor_	(Import/Export)
Traces	Trace_	(Import/Export)
Limit Lines	LLine_	(Import/Export)
Measurement Result	MeasR_	(Import/Export)
Capture Buffer	CapBuf_	(Import/Export)

A four digit number is appended to the prefix to create a unique file name. The numbering sequence starts at 0000 within each Mode for each file type and updates incrementally to 9999, then wraps to 0000 again. It remembers where it was through a Mode Preset and when leaving and returning to the Mode. It is reset by Restore Misc Defaults and Restore System Defaults and subsequent running of the instrument application. So, for example, the first auto file name generated for State files is State_0000.state. The next is State_0001, and so forth.

One of the key features of Auto File Name is that we guarantee that the Auto File Name will never conflict with an existing file. The algorithm looks for the next available number. If it gets to 9999, then it looks for holes. If it find no holes, that is no more numbers are available, it gives an error.

For example, if when we get to State_0010.state there is already a State_0010.state file in the current directory, it advances the counter to State_0011.state to ensure that no conflict will exist (and then it verifies that State_0011.state also does not exist in the current directory and advances again if it does, and so forth).

System Functions

Quick Save

If you enter a file name for a given file type, then the prefix becomes the filename you entered instead of the default prefix, followed by an underscore. The last four letters (the suffix) are the 4-digit number.

For example, if you save a measurement results file as “fred.csv”, then the next auto file name chosen for a measurement results save will be fred_0000.csv.

NOTE Although 0000 is used in the example above, the number that is used is actually the current number in the Meas Results sequence, that is, the number that would have been used if you had not entered your own file name.

NOTE If the filename you entered ends with _dddd, where d=any number, making it look just like an auto file name, then the next auto file name picks up where you left off with the suffix being dddd + 1.

Key Path	Front-panel key
Notes	No remote command for this key specifically.
Initial S/W Revision	Prior to A.02.00

Recall

Accesses a menu that enables you to select the information that you want to recall.

The options are State, Trace and Data. (screen images can be saved, but not recalled.) The default paths for Recall are data type dependent and are the same as for the Save key.

Key Path	Front-panel key
Notes	No remote command directly controls the Recall Type that this key controls. The Recall type is a node in the :MMEM:LOAD command. An example is :MMEM:LOAD:STATe <filename>.
Initial S/W Revision	Prior to A.02.00

State

Accesses a menu that enables you to recall a State that has previously been saved. Recalling a saved state returns the analyzer as close as possible to the mode context and may cause a mode switch if the file selected is not for the current active mode. A State file can be recalled from either a register or a file. Once you select the source of the recall in the State menu, the recall will occur.

Key Path	Recall
Mode	All
Example	MMEM:LOAD:STAT "MyStateFile.state" This loads the state file data (on the default file directory path) into the instrument state.
Notes	See “Open” on page 155.
Initial S/W Revision	Prior to A.02.00

In measurements that support saving Traces, for example, Swept SA, the Trace data is saved along with the State in the State file. When recalling the State, the Trace data is recalled as well. Traces are recalled exactly as they were stored, including the writing mode and update and display modes. If a Trace was updating and visible when the State was saved, it will come back updating and visible, and its data will be rewritten right away. When you use State to save and recall traces, any trace whose data must be preserved should be placed in View or Blank mode before saving.

The following table describes the Trace Save and Recall possibilities:

You want to recall state and one trace's data, leaving other traces unaffected.	Save Trace+State from 1 trace. Make sure that no other traces are updating (they should all be in View or Blank mode) when the save is performed.	On Recall, specify the trace you want to load the one trace's data into. This trace will load in View. All other traces' data will be unaffected, although their trace mode will be as it was when the state save was performed.
---	---	--

System Functions

Recall

You want to recall all traces	Save Trace+State from ALL traces.	On Recall, all traces will come back in View (or Blank if they were in Blank or Background when saved)
You want all traces to load exactly as they were when saved.	Save State	On recall, all traces' mode and data will be exactly as they were when saved. Any traces that were updating will have their data immediately overwritten.

Register 1 thru Register 6

Selecting any one of these register keys causes the State of the mode from the specified Register to be recalled. Each of the register keys annotates whether it is empty or at what date and time it was last modified.

Registers are shared by all modes, so recalling from any one of the 6 registers may cause a mode switch to the mode that was active when the save to the Register occurred.

After the recall completes, the message "Register <register number> recalled" appears in the message bar.

Key Path	Recall, State
Example	*RCL 1
Readback	Date and time with seconds resolution of the last Save is displayed on the key, or "(empty)" if no prior save operation performed to this register.
Initial S/W Revision	Prior to A.02.00

Key Path	Recall, State
Example	*RCL 2
Readback	Date and time with seconds resolution of the last Save is displayed on the key, or "(empty)" if no prior save operation performed to this register.
Initial S/W Revision	Prior to A.02.00

Key Path	Recall, State
Example	*RCL 3
Readback	Date and time with seconds resolution of the last Save is displayed on the key, or "(empty)" if no prior save operation performed to this register.
Initial S/W Revision	Prior to A.02.00

Key Path	Recall, State
Example	*RCL 4

Readback	Date and time with seconds resolution of the last Save is displayed on the key, or "(empty)" if no prior save operation performed to this register.
Initial S/W Revision	Prior to A.02.00

Key Path	Recall, State
Example	*RCL 5
Readback	Date and time with seconds resolution of the last Save is displayed on the key, or "(empty)" if no prior save operation performed to this register.
Initial S/W Revision	Prior to A.02.00

Key Path	Recall, State
Example	*RCL 6
Readback	Date and time with seconds resolution of the last Save is displayed on the key, or "(empty)" if no prior save operation performed to this register.
Initial S/W Revision	Prior to A.02.00

From File\ File Open

Brings up the standard Windows® File Open dialog and its corresponding key menu.

When you first enter this dialog, the State File default path is in the Look In: box in this File Open dialog. The File Open dialog is loaded with the file information related to the State Save Type. The first *.state file is highlighted. The only files that are visible are the *.state files and the Files of type is *.state, since .state is the file suffix for the State save type. For more details, refer to [“Open” on page 166](#).

Key Path	Recall, State
Notes	Brings up the Open dialog for recalling a State Save Type
Initial S/W Revision	Prior to A.02.00

Open

The recalling State function must first verify the file is recallable in the current instrument by checking the software version and model number of the instrument. If everything matches, a full recall proceeds by aborting the currently running measurement, and then loading the State from the saved state file to as close as possible to the context in which the save occurred. You can open state files from any mode, so recalling a State file switches to the mode that was active when the save occurred. After switching to the mode of the saved state file, mode settings and data (if any for the mode) are loaded with values from the saved file. The saved measurement of the mode becomes the newly active measurement and the data relevant to the measurement (if there is any) is recalled.

If there is a mismatch between file version or model number or instrument version or model number, the recall function tries to recall as much as possible and it returns a warning message of what it did.

NOTE No Trace data is loaded when recalling a State File. Measurements that support

System Functions
Recall

loading of trace data will include a Trace key in the Recall menu and will load State + Trace data from .trace files under that key.

Key Path	Recall, State, From File...
Remote Command	:MMEMory:LOAD:STATe <filename>
Example	:MMEM:LOAD:STAT "myState.state" recalls the file myState.state on the default path
Notes	Auto return to the State menu and the Open dialog goes away. Advisory Event "Recalled File <file name>" after recall is complete.
Notes	If the file specified is empty an error is generated. If the specified file does not exist, another error is generated. If there is a mismatch between the file and the proper file type, an error is generated. If there is a mismatch between file version or model number or instrument version or model number, a warning is displayed. Then it returns to the State menu and File Open dialog goes away. Although the trace data is included in the .state file it is not recalled. Recalling trace data is left for .trace files only for measurements that support recalling of trace data. Errors are generated if the specified file is empty or does not exist, or there is a file type mismatch.
Initial S/W Revision	Prior to A.02.00

The state of a mode includes all of the variables affected by doing a full preset. It not only recalls Mode Preset settings, but it also recalls all of the mode persistent settings and data if the mode has either. Each mode determines whether data is part of mode state and if the mode has any persistent settings. **Recall State** also recalls all of the **Input/Output** system settings, since they are saved with each State File for each mode.

The Recall State function does the following:

- Verifies that the file is recallable on this instrument using the version number and model number.
- Aborts the currently running measurement.
- Clears any pending operations.
- Switches to the mode of the selected Save State file.
- Sets mode State and Input/Output system settings to the values in the selected Saved State file.
- Limits settings that differ based on model number, licensing or version number.
- Makes the saved measurement for the mode the active measurement.
- Clears the input and output buffers.
- Status Byte is set to 0.
- Executes a *CLS

Trace (+State)

Select Trace as the data type to be recalled. Trace files include the state of the mode they were saved from as well as the trace data, with internal flags to indicate which trace the user was trying to save, which may include ALL traces. They are otherwise identical to State files. Recalling **trace data** may cause a mode switch if the file selected is not for the currently active mode.

Not all modes support saving of trace data with the state, and for modes that do, not all measurements do. The Trace key is grayed out for measurements that do not support trace recall. It is blanked for modes that do not support trace recall.

This key will not actually cause the recall, since the recall feature still needs to know from which file to recall the trace and which trace to recall it into. Pressing this key will bring up the Recall Trace menu that provides you with the options of where to retrieve the trace.

For quick recalls, the Trace menu lists 5 registers to recall from or you can select a file to recall from.

Key Path	Recall
Mode	SA
Example	MMEM:LOAD:TRAC TRACE2,"MyTraceFile.trace" This loads the trace file data (on the default file directory path) into the specified trace. :MMEM:LOAD:TRAC:REG TRACE1,2 restores the trace data in register 2 to Trace 1
Initial S/W Revision	Prior to A.02.00

Register 1 thru Register 5

Selecting any one of these register keys causes the Traces and State from the specified Register to be recalled. Each of the register keys annotates whether it is empty or at what date and time it was last modified.

Trace registers are shared by all modes, so recalling from any one of the 5 registers may cause a mode switch to the mode that was active when the save to the Register occurred.

After the recall completes, the message "Trace Register <register number> recalled" appears in the message bar.

Key Path	Recall, Trace
Readback	Date and time with seconds resolution of the last Save is displayed on the key, or "(empty)" if no prior save operation performed to this register.
Initial S/W Revision	Prior to A.02.00

Key Path	Recall, Trace
Readback	Date and time with seconds resolution of the last Save is displayed on the key, or "(empty)" if no prior save operation performed to this register.

System Functions
Recall

Initial S/W Revision	Prior to A.02.00
----------------------	------------------

Key Path	Recall, Trace
Readback	Date and time with seconds resolution of the last Save is displayed on the key, or "(empty)" if no prior save operation performed to this register.
Initial S/W Revision	Prior to A.02.00

Key Path	Recall, Trace
Readback	Date and time with seconds resolution of the last Save is displayed on the key, or "(empty)" if no prior save operation performed to this register.
Initial S/W Revision	Prior to A.02.00

Key Path	Recall, Trace
Readback	Date and time with seconds resolution of the last Save is displayed on the key, or "(empty)" if no prior save operation performed to this register.
Initial S/W Revision	Prior to A.02.00

To Trace

These menu selections let you pick which Trace to recall the saved trace into. Not all modes have the full 6 traces available. The default is the currently selected trace, selected in this menu or in the Trace/Detector, Export Data, Import Data, or Save Trace menus, except if you have chosen All, then it remains chosen until you specifically change it to a single trace.

If the .trace file is an "all trace" file, "**To Trace**" is ignored and the traces each go back to the trace they were saved from.

Once selected, the key returns back to the Recall Trace menu and the selected Trace number is annotated on the key. Now you have selected exactly where the trace needs to be recalled. To trigger a recall of the selected Trace, you must select the **Open** key in the Recall Trace menu.

Key Path	Save, Data, Trace
Mode	SA
Initial S/W Revision	Prior to A.02.00

Open...

Accesses the standard Windows File Open dialog and its corresponding File Open menu. When you navigate to this selection, you have already determined you are recalling Trace and now you want to specify from which file to do the recall.

When you first enter this dialog, the State File default path is in the Look In: box. The **File Open** dialog is loaded with the file information related to the State Save Type. The first *.trace file is highlighted. Also, the only files that are visible are the *.trace files and the Files of type is *.trace, since .trace is the

file suffix for the Trace save type. For more details, refer to [“File Open Dialog and Menu” on page 166](#).

Key Path	Recall, Trace
Mode	SA
Notes	Brings up Open dialog for recalling a Trace Save Type
Initial S/W Revision	Prior to A.02.00

Open

The recalling Trace function must first verify the file is recallable in this instrument by checking instrument software version and model number, since it includes State. If everything matches, a full recall proceeds by aborting the currently running measurement, and loading the state from the saved state file to as close as possible to the context in which the save occurred. You can open .trace files from any mode that supports them, so recalling a Trace file switches to the mode that was active when the save occurred. After switching to the mode of the saved state file, mode settings and data (if any for the mode) are loaded with values from the saved file and the saved measurement of the mode becomes the newly active measurement, and the data relevant to the measurement (if there is any) is recalled.

Once the state is loaded, the trace data must be loaded. The internal flags are consulted to see which trace to load and the "To Trace" setting to see where to load it. Trace data is always loaded with the specified trace set to View, so that the data is visible and not updating(so as not to erase the recalled data). If the file is an "all trace" file, all traces are loaded with the saved data(to the original trace the data was saved from) and set to View. Traces whose data is not loaded are restored to the update state that existed when they were saved.

In every other way a Trace load is identical to a State load. See section [“File Open Dialog and Menu” on page 166](#) for details.

Key Path	Recall, Trace, Open...
Remote Command	:MMEMory:LOAD:TRACe TRACE1 TRACE2 TRACE3 TRACE4 TRACE5 TRACE6 , <filename> :MMEMory:LOAD:TRACe:REGister TRACE1 TRACE2 TRACE3 TRACE4 TRACE5 TRACE6 , <integer>
Example	:MMEM:LOAD:TRAC TRACE2,"myState.trace" recalls the file myState.trace on the default path; if it is a "single trace" save file, that trace is loaded to trace 2, and is set to be not updating. :MMEM:LOAD:TRAC:REG TRACE1,2 restores the trace data in register 2 to Trace 1

Notes	<p>Auto return to the Trace menu and the Open dialog goes away.</p> <p>Advisory Event "Recalled File <file name>" after recall is complete.</p> <p>Some modes and measurements do not have available all 6 traces. Phase Noise mode command, for example, is: MMEMoRY:LOAD:TRACe TRACE1 TRACE2 TRACE3,<filename></p> <p>The load trace command actually performs a load state, which in the Swept SA measurement includes the trace data. However it looks in the recalled state file to see how it was flagged at save time. The possibilities are:</p> <p>If the trace file was saved using one of the TRACE# enums, it is flagged as a single trace save file. The trace that was flagged as the one that was saved, is loaded to the trace specified. The trace is loaded with update off and display on, and none of the other traces are loaded.</p> <p>If the trace file was saved using one the ALL enum, it is flagged as an "all traces" file. And all traces will be loaded. All of the traces are loaded with Update=Off to keep them from updating, regardless of the setting of "Recall State w/Trace Update".</p>
Initial S/W Revision	Prior to A.02.00

Data (Import)

Importing a data file loads data that was previously saved from the current measurement or from other measurements and/or modes that produce the same type of data. The Import Menu only contains Data Types that are supported by the current measurement.

Since the commonly exported data files are in .csv format, the data can be edited by the user prior to importing. This allows you to export a data file, manipulate the data in Excel (the most common PC Application for manipulating .csv files) and then import it.

Importing Data loads measurement data from the specified file into the specified or default destination, depending on the data type selected. Selecting an Import Data menu key will not actually cause the importing to occur, since the analyzer still needs to know from where to get the data. Pressing the Open key in this menu brings up the Open dialog and Open menu that provides you with the options from where to recall the data. Once a filename has been selected or entered in the Open menu, the recall occurs as soon as the Open key is pressed.

Key Path	Recall
Mode	All
Notes	<p>The menu is built from whatever data types are available for the mode. Some keys will be missing completely, so the key locations in the sub-menu will vary.</p> <p>No SCPI command directly controls the Data Type that this key controls. The Data Type is included in the MMEM:LOAD commands.</p>
Dependencies	If a file type is not used by a certain measurement, it is grayed out for that measurement. The key for a file type will not show at all if there are no measurements in the Mode that support it.

Preset	Is not affected by Preset or shutdown, but is reset during Restore Mode Defaults
Readback	The data type that is currently selected
Initial S/W Revision	Prior to A.02.00

Trace

This key selects Trace as the data type to be imported. When pressed a second time, it brings up the Trace Menu, which lets you select the Trace into which the data will be imported.

This key is grayed out when measurements are running that do not support trace importing.

For Vector Signal Analyzer Mode:

The trace data is loaded into the selected data register. Trace data registers are temporary storage places for trace data. They allow you to view past results next to current measurement results, and are also used in some functions like user defined filters. They are measurement global, so you can import data into a register while in the Digital Demod measurement and view it later while in the Vector measurement. Data registers are cleared when the measurement application is terminated, but not when you change Modes and return.

If the recalled file was saved with header information, the trace will initially be displayed with the same formatting and scaling as it had when it was saved. If headers are not saved, the scaling and format are set to defaults when the trace is recalled.

The following trace data formats may be imported:

- Text and comma-separated variable (CSV)
- Text
- SDF.

Option 200 also allows import of these additional formats:

- Matlab 4
- Matlab 5
- Matlab HDF5
- N5110A compatible binary

Key Path	Recall, Data
Remote Command	:MMEMory:LOAD:TRACe:DATA TRACE1 TRACE2 TRACE3 TRACE4 TRACE5 TRACE6 , <filename>
Example	:MMEM:LOAD:TRAC DATA TRACE2,"myTrace2.csv" imports the 2nd trace from the file myTrace2.csv in the current path. The default path is My Documents\SA\data\traces

System Functions
Recall

Notes	<p>For VSA Mode: The Open...dialog box has the following filter options when you are recalling trace data:</p> <ul style="list-style-type: none"> • CSV (Comma delimited) (*.csv) • SDF (Fast) (*.sdf;*.dat) • Text (Tab delimited) (*.txt) • MAT-File (*.mat) • MAT-File (Version 4) (*.mat) • MAT-File (HDF5) (*.mat;*.hdf;*.h5) • N5110A Waveform (*.bin) <p>The file format recalled depends on selection.</p>
Dependencies	<p>Trace data is not available from all Measurements. When unavailable, the key will be grayed out. The key will not show if no measurements in the Mode support it.</p> <p>If any error occurs while trying to load a file manually (as opposed to during remote operation), the analyzer returns to the Import Data menu and the File Open dialog goes away.</p>
Couplings	<p>When a trace is imported, Trace Update is always turned OFF for that trace and Trace Display is always turned ON.</p>
Readback	<p>Other than VSA: 1 2 3 4 5 6</p> <p>VSA: Data 1 Data 2 Data 3 Data 4 Data 5 Data 6</p>
Initial S/W Revision	Prior to A.02.00

Trace 1, 2, 3, 4, 5, 6

Enables you to select which Trace to import the data into either 1, 2, 3, 4, 5 or 6. The default is the currently selected trace, which was selected in this menu or in the Trace/Det, Export Data, Recall Trace, or Save Trace menus. The exception is, if you have chosen All then it remains chosen until you specifically change it to a single trace.

Once selected, the key returns back to the Import Data menu and the selected Trace number is annotated on the key. Now you have selected exactly what needs to be imported. To trigger an import of the selected trace, you must select the Open key in the Import Data menu.

An example of using this menu is: If you select 4 and continue to the File Open dialog, then import Trace 4 from the file selected or entered in File Name option in the File Open dialog.

Key Path	Recall, Data, Trace
Initial S/W Revision	Prior to A.02.00

Display in Selected Trace

In Vector Signal Analyzer Mode, data registers are used as temporary storage places for trace data.

A register may be displayed in any trace. If the Display in Selected Trace key is set to "Yes" then the data

register into which the file is recalled is then assigned to the currently selected trace.

Key Path	Recall, Data (Import), Trace (to)
Example	MMEM:LOAD:TRAC:DATA D1,"TRC1.TXT",TXT This command explicitly puts the data in the specified trace.
Mode	VSA
Initial S/W Revision	Prior to A.02.00

Capture Buffer

Capture Buffer functionality is not available for all measurements. The captured data is raw data (unprocessed).

Key Path	Recall, Data
Example	MMEM:LOAD:CAPT "MyCaptureData.bin" This loads the file of capture data (on the default file directory path) into the instrument.
Mode	WCDMA
Dependencies	Capture buffer data is not available from all Measurements. When unavailable, the key will be grayed out. The key will not show if no measurements in the Mode support it.
Initial S/W Revision	Prior to A.02.00

Mask

NOTE This key is only valid on Spectrum Emission Mask and ACP measurements.

Recalls a preset mask file that will be provided by the XSA FW installer package. You can select one provided preset mask file from the list. Unlike in the case of the normal state file, the preset mask file contains the configuration for Carrier, Offset, Limit settings and preset profile BW only. When importing a preset mask file, it uses the XSA Recall function and overwrites the set of values with the contents of preset mask file. The other set of values that are not specified by the preset mask file are not changed. The file type is a binary file format and you cannot change or create the preset mask file. This feature applies for Spectrum Emission Mask, and ACP measurements and will be grayed out when any other measurement is selected.

File type: The file type is a binary file.

File location: The preset mask file is located in “My Documents\<<mode>\data\masks”. The location “My Documents” is an alias to a directory and its place is dependant upon which user is logged in. At XSA start up, XSA will overwrite all of the limit mask files to the current user’s “My Documents\<<mode>\data\masks” each time.

File Name: The file name is decided by following naming rules. Each specific keyword is connected with underscore.

Recall

<Direction>_<Bandwidth>_<Measurement>_<Condition>.mask

Where

<Direction>: This term means that the limit mask file is for which Direction, Downlink or Uplink.

<Bandwidth>: This term means that the limit mask file is for which Bandwidth.

<Measurement>: This term means that the limit mask file is applied on which measurement. It is SEM, ACP or Mode. Mode means it overwrites the values of some parameters in both ACP, and SEM measurement.

<Condition>: This term means that the limit mask file is applied on which condition. It is depends on the measurement. For example, in case of Spectrum Emission Mask measurement, CategoryB might be fine. In case of ACP, NS_02, etc.

File extension: The extension of the preset mask file is “mask” since it needs to distinguish between the state file and preset mask file.

When you press the open key under the Data menu, “My Documents\<mode>\data\masks” is opened. You can select one mask file. When you change the Bandwidth or Direction, all Power Suite measurement parameters are reset to the hard coded preset parameters in each case. Thus, you must recall the appropriate preset mask file again after the change.

You cannot read the contents of the provided preset mask file since its file is a binary file. Detailed contents of the file are provided by a PDF format file located in the same directory as preset mask file.

The set of variables in the following table are imported to the ACP measurement.

Offset	Start Freq (MHz)	Stop Freq (MHz)	Res BW (Hz)	Meas BW	Rel Start	Rel Stop	Fail Mask
A	5	7.14	30k	1	-8	-25	Rel
B	7.14	10.57	30k	1	-25	-27	Rel
C	10.57	20	30k	1	-27	-50	Rel
D	20	25	30k	1	-50	-50	Rel
E	25	30	30k	1	-50	-50	Rel

Key Path	Recall, Data
Mode	LTE, LTETDD
Remote Command	MMEMOry:LOAD:MASK <string>
Example	MMEM:LOAD:MASK "File location path and filename"
Notes	Set of parameters related to Limit, Carrier and Offset are overwritten by contents of the Preset mask file.
Instrument S/W Revision	A.02.00

Zone map

A map file contains zone definitions that help simplify making measurements of frequently used signals. The OFDMA frame structure can contain multiple-zone definitions for the uplink and downlink subframes and multiple data burst allocations. You can recall map files in which you have saved complicated OFDMA frame analysis zone definitions. This can save you time and ensure the accuracy of repeat measurements. Map files are also useful for recreating measurement settings so they can be used by other users.

Key Path	Recall, Data
Example	MMEM:LOAD:ZMAP "MyZonemapFile.omf" This loads the file of zone map data (on the default file directory path) into the custom map.
Mode	OFDMA WIMAX
Dependencies	Zone map data is not available from all Measurements. When unavailable, the key will be grayed out. The key will not show if no measurements in the Mode support it.
Initial S/W Revision	Prior to A.02.00

Recorded Data

This allows you to recall previously saved, recorded data for analysis.

This feature is only available with 89601X VSA Option 200 and Option G01.

Key Path	Recall, Data (Import)
Example	MMEM:LOAD:REC "MyRecording.sdf"
Mode	VSA
Notes	Available file types are: <ul style="list-style-type: none"> • CSV (Comma delimited) (*.csv) • MAT-File (*.mat) • MAT-File (Version 4) (*.mat) • MAT-File (HDF5) (*.mat;*.hdf;*.h5) • N5110A Waveform (*.bin) • SDF (Fast) (*.sdf;*.dat) • SDF (Export) (*.sdf;*.dat) • Text (Tab delimited) (*.txt)
Initial S/W Revision	Prior to A.02.00

Open...

Accesses the standard Windows File Open dialog and the File Open key menu. When you navigate to

System Functions

Recall

this selection, you have already determined you are recalling a specific Data Type and now you want to specify which file to open.

When you first enter this dialog, the path in the Look In: field depends on which import data type you selected.

The only files that are visible are those specific to the file type being recalled.

Key Path	Recall, Data
Notes	The key location is mode-dependent and will vary. Brings up Open dialog for recalling a <mode specific> Save Type
Initial S/W Revision	Prior to A.02.00

Open

The import starts by checking for errors. Then the import can start. For all data types, the actual import starts by aborting the currently running measurement. Then the import does data type specific behavior:

File Open Dialog and Menu

The **File Open** is a standard Windows dialog and has a **File Open** key menu. Each key in this menu corresponds to the selectable items in the **File Open** dialog box. The menu keys can be used for easy navigation between the selections within the dialog or the standard **Tab** and **Arrow** keys can be used for dialog navigation. When you navigate to this selection, you have already limited the file recall type and now you want to specify which file to open.

Initial S/W Revision:	Prior to A.02.00
-----------------------	------------------

Open

This selection and the **Enter** key, when a filename has been selected or specified, cause the load to occur. **Open** loads the specified or selected file to the previously selected recall type of either **State** or a specific import data type.

Notes	Advisory Event "File <file name> recalled" after recall is complete.
Initial S/W Revision	Prior to A.02.00

File/Folder List

This menu key navigates to the center of the dialog that contains the list of files and folders. Once here you can get information about the file.

Key Path	Recall, <various>, Open...
Notes	Pressing this key navigates you to the files and folders list in the center of the dialog.
Initial S/W Revision	Prior to A.02.00

Sort

Accesses a menu that enables you to sort the files within the File Open dialog. Only one sorting type can be selected at a time and the sorting happens immediately.

Key Path	Recall, <various>, Open...
Notes	No SCPI command directly controls the sorting.
Initial S/W Revision	Prior to A.02.00

By Date

Accesses a menu that enables you to sort the list of files within the scope of the File Open dialog in ascending or descending data order. The date is the last data modified.

Key Path	Recall, <various>, Open..., Sort
Notes	Files in the File Open dialog are sorted immediately in the selected order
Initial S/W Revision	Prior to A.02.00

By Name

Accesses a menu that enables you to sort the list of files within the scope of the File Open dialog in ascending or descending order based on the filename.

Key Path	Recall, <various>, Open..., Sort
Notes	Files in the File Open dialog are sorted immediately in the selected order
Initial S/W Revision	Prior to A.02.00

By Extension

Accesses a menu that enables you to sort the list of files within the scope of the File Open dialog in ascending or descending order based on the file extension for each file.

Key Path	Recall, <various>, Open..., Sort
Notes	Files in the File Open dialog are sorted immediately in the selected order
Initial S/W Revision	Prior to A.02.00

By Size

Accesses a menu that enables you to sort the list of files within the scope of the File Open dialog in ascending or descending order based on file size.

Key Path	Recall, <various>, Open..., Sort
Notes	Files in File Open dialog are sorted immediately in the selected order

System Functions

Recall

Initial S/W Revision	Prior to A.02.00
----------------------	------------------

Ascending

This causes the display of the file list to be sorted, according to the sort criteria, in ascending order.

Key Path	Recall, <various>, Open..., Sort
Notes	Files in File Open dialog are sorted immediately in the selected order
Initial S/W Revision	Prior to A.02.00

Descending

This causes the display of the file list to be sorted, according to the sort criteria, in descending order.

Key Path	Recall, <various>, Open..., Sort
Notes	Files in File Open dialog are sorted immediately in the selected order
Initial S/W Revision	Prior to A.02.00

Files Of Type

This menu key corresponds to the Files Of Type selection in the dialog. It follows the standard Windows supported Files Of Type behavior. It shows the current file suffix that corresponds to the type of file the user has selected to save. If you navigated here from recalling State, "State File (*.state)" is in the dialog selection and is the only type available in the pull down menu. If you navigated here from recalling Trace, "Trace+State File (*.trace)" is in the dialog selection and is the only type available under the pull down menu.

If you navigated here from importing a data file, the data types available will be dependent on the current measurement and the selection you made under "Import Data". For example:

Amplitude Corrections: pull down menu shows

- Amplitude Corrections (*.csv)
- Legacy Cable Corrections (*.cbl)
- Legacy User Corrections (*.amp)
- Legacy Other Corrections (*.oth)
- Legacy Antenna Corrections (*.ant)

Limit: pull down menu shows

- Limit Data (*.csv)
- Legacy Limit Data (*.lim)

Trace: pull down menu shows

- Trace Data (*.csv)

Key Path	Recall, <various>, Open...
Notes	Pressing this key causes the pull down menu to list all possible file types available in this context.
Initial S/W Revision	Prior to A.02.00

Up One Level

This menu key corresponds to the icon of a folder with the up arrow that is in the tool bar of the dialog. It follows the standard Windows supported Up One Level behavior. When pressed, it directs the file and folder list to navigate up one level in the directory structure.

Key Path	Recall, <various>, Open...
Notes	When pressed, the file and folder list is directed up one level of folders and the new list of files and folders is displayed.
Initial S/W Revision	Prior to A.02.00

Cancel

Cancels the current File Open request. It follows the standard Windows supported Cancel behavior.

Key Path	Recall, <various>, Open...
Notes	Pressing this key causes the Open dialog to go away and auto return.
Initial S/W Revision	Prior to A.02.00

Save

Accesses a menu that provides the save type options. The **Save Type** options are **State**, **Trace**, **Data**, or a **Screen Image** depending on the active mode.

Key Path	Front-panel key
Mode	All
Notes	No remote command for this key specifically.
Initial S/W Revision	Prior to A.02.00

State

Selects **State** as the save type and accesses a menu that provides the options of where to save. You can save either to a register or a file. This menu key will not actually cause the save until the location is chosen.

Saving the state is the only way to save this exact measurement context for the current active mode. The entire state of the active mode is saved in a way that when a recall is requested, the mode will return to as close as possible the context in which the save occurred. This includes all settings and data for only the current active mode.

It should be noted that the Input/Output settings will be saved when saving State, since these settings plus the state of the mode best characterize the current context of the mode, but the mode independent System settings will not be saved.

For rapid saving, the State menu lists registers to save to, or you can select a file to save to. Once they select the destination of the save in the State menu, the save will occur.

Key Path	Save
Mode	All
Example	MMEM:STOR:STATe "MyStateFile.state" This stores the current instrument state data in the file MyStateFile.state in the default directory.
Notes	See “Save” on page 176 .
Initial S/W Revision	Prior to A.02.00

Register 1 thru Register 6

Selecting any one of these register menu keys causes the State of the currently active mode to be saved to the specified Register. The registers are provided for rapid saving and recalling, since you do not need to specify a filename or navigate to a file. Each of the register menu keys annotates whether it is empty or at what date and time it was last modified.

These 6 registers are all that is available from the front panel for all modes in the instrument. There are not 6 registers available for each mode. From remote, 127 Registers are available. Registers are files that

are visible to the user in the My Documents\System folder.

Key Path	Save, State
Mode	All
Example	*SAV 1
Readback	Date and time with seconds resolution are displayed on the key, or "(empty)" if no prior save operation performed to this register.
Initial S/W Revision	Prior to A.02.00

Key Path	Save, State
Mode	All
Example	*SAV 2
Readback	Date and time with seconds resolution are displayed on the key, or "(empty)" if no prior save operation performed to this register.
Initial S/W Revision	Prior to A.02.00

Key Path	Save, State
Mode	All
Example	*SAV 3
Readback	Date and time with seconds resolution are displayed on the key, or "(empty)" if no prior save operation performed to this register.
Initial S/W Revision	Prior to A.02.00

Key Path	Save, State
Mode	All
Example	*SAV 4
Readback	Date and time with seconds resolution are displayed on the key, or "(empty)" if no prior save operation performed to this register.
Initial S/W Revision	Prior to A.02.00

Key Path	Save, State
Mode	All
Example	*SAV 5
Readback	Date and time with seconds resolution are displayed on the key, or "(empty)" if no prior save operation performed to this register.
Initial S/W Revision	Prior to A.02.00

System Functions
Save

Key Path	Save, State
Mode	All
Example	*SAV 6
Readback	Date and time with seconds resolution are displayed on the key, or "(empty)" if no prior save operation performed to this register.
Initial S/W Revision	Prior to A.02.00

To File . . .

Accesses a menu that enables you to select the location for saving the State. This menu is similar to a standard Windows® **Save As** dialog.

The default path for all State Files is:

My Documents\<<mode name>\state

where <mode name> is the parameter used to select the mode with the INST:SEL command (for example, SA for the Spectrum Analyzer). This path is the **Save In:** path in the **Save As** dialog for all State Files when they first enter this dialog.

Key Path	Save, State
Mode	All
Notes	Brings up Save As dialog for saving a State Save Type
Initial S/W Revision	Prior to A.02.00

Save As . . .

Accesses a menu that enables you to select the location where you can save the State. This menu is a standard Windows® dialog with Save As menu keys. The "File Name" field in the Save As dialog is initially loaded with an automatically generated filename specific to the appropriate Save Type. The automatically generated filename is guaranteed not to conflict with any filename currently in the directory. You may replace or modify this filename using the File Name softkey. See the Quick Save key documentation for more on the automatic file naming algorithm.

The default path for all State Files is:

My Documents\<<mode name>\state

where <mode name> is the parameter used to select the mode with the INST:SEL command (for example, SA for the Spectrum Analyzer).

When you first enter this dialog, the path in the **Save In:** field depends on the data type. The only files that are visible are the *.state files and the Save As type is *.state, since .state is the file suffix for the State Save Type.

Key Path	Save, State
Mode	All

Notes	Brings up Save As dialog for saving a State Save Type
Initial S/W Revision	Prior to A.02.00

Save

Saves all of the State of the currently active mode plus the system level Input/Output settings to the specified file.

While the save is being performed, the floppy icon shows up in the settings bar near the Continuous/Single sweep icon. After the save completes, the Advisory Event "File <register number> saved" is displayed.

Key Path	Save, State, To File...
Mode	All
Remote Command	:MMEMory:STORe:STATe <filename>
Example	:MMEM:STOR:STAT "myState.state" saves the file myState.state on the default path
Notes	If the file already exists, the file will be overwritten. Using the C: drive is strongly discouraged, since it runs the risk of being overwritten during an instrument software upgrade. Both single and double quotes are supported for any filename parameter over remote. Auto return to the State menu and the Save As dialog goes away.
Backwards Compatibility SCPI	For a backwards compatibility only, the following parameters syntax is supported: :MMEMory:STORe:STATe 1,<filename> The "1" is just ignored. The command is sequential.
Initial S/W Revision	Prior to A.02.00

Trace (+State)

Selects a state file which includes trace data for recalling as the save type and accesses a menu that enables you to select which trace to save. You can save to either a register or a file. Not all modes support saving trace data with the state, and for modes that do, not all measurements do. This key is grayed out for measurements that do not support trace saves. It is blanked for modes that do not support trace saves. Saving **Trace** is identical to saving State except a .trace extension is used on the file instead of .state, and internal flags are set in the file indicating which trace was saved. You may also select to save ALL traces.

This key will not actually cause the save, since the save feature still needs to know which trace to save and where to save it. Pressing this key accesses the Save Trace menu that provides the user with these options.

For rapid saving, the Trace menu lists registers to save to, or you can select a file to save to. Once you

pick the destination of the save in the Trace menu, the save will occur.

Key Path	Save
Mode	SA
Example	MMEM:STOR:STATe TRACE2,"MyTraceFile.trace" This stores trace 2 data in the file MyTraceFile.trace in the default directory. :MMEM:STOR:TRAC:REG TRACE1,2 stores trace 1 data in trace register 2 :MMEM:STOR:TRAC:REG ALL,3 saves the data for all 6 traces in trace register 3
Notes	See "Save" on page 176 .
Initial S/W Revision	Prior to A.02.00

Register 1 thru Register 5

Selecting any one of these register menu keys causes the Trace(s) specified under From Trace, along with the state of the currently active mode, to be saved to the specified Trace Register. The registers are provided for rapid saving and recalling, since you do not need to specify a filename or navigate to a file. Each of the register menu keys annotates whether it is empty or at what date and time it was last modified.

These 5 trace registers are all that is available for all modes in the instrument. At present, only the Swept SA measurement of the Spectrum Analyzer mode supports saving to Trace+State files. Registers are files that are visible to the user in the My Documents\System folder.

Key Path	Save, Trace
Mode	SA
Readback	Date and time with seconds resolution are displayed on the key, or "(empty)" if no prior save operation performed to this register.
Initial S/W Revision	Prior to A.02.00

Key Path	Save, Trace
Mode	SA
Readback	Date and time with seconds resolution are displayed on the key, or "(empty)" if no prior save operation performed to this register.
Initial S/W Revision	Prior to A.02.00

Key Path	Save, Trace
Mode	SA
Readback	Date and time with seconds resolution are displayed on the key, or "(empty)" if no prior save operation performed to this register.

Initial S/W Revision	Prior to A.02.00
----------------------	------------------

Key Path	Save, Trace
Mode	SA
Readback	Date and time with seconds resolution are displayed on the key, or "(empty)" if no prior save operation performed to this register.
Initial S/W Revision	Prior to A.02.00

Key Path	Save, Trace
Mode	SA
Readback	Date and time with seconds resolution are displayed on the key, or "(empty)" if no prior save operation performed to this register.
Initial S/W Revision	Prior to A.02.00

From Trace

Accesses a menu that enables you to select the trace to be saved. Once a trace is selected, the key returns to the Save Trace menu and the selected trace number is annotated on the key. The default is the currently selected trace, selected in this menu or in the Trace/Det, Export Data, Import Data or Recall Trace menus, except if you have chosen All then it remains chosen until you specifically change it to a single trace. To save the Trace you must select **Save As**.

These keys let you pick which trace to save. Now you have selected exactly what needs to be saved. To trigger a save of the selected **Trace**, you must select the **Save As** key in the Save Trace menu.

Key Path	Save, Trace + State
Mode	SA
Initial S/W Revision	Prior to A.02.00

Save As . . .

This menu lets you select the location where you can save the Trace. It is a standard Windows® dialog with Save As menu keys.

The "File Name" field in the Save As dialog is initially loaded with an automatically generated filename specific to the appropriate Save Type. The automatically generated filename is guaranteed not to conflict with any filename currently in the directory. You may replace or modify this filename using the File Name softkey. See the Quick Save key documentation for more on the automatic file naming algorithm.

The default path for all State Files including .trace files is:

My Documents\<<mode name>\state

where <mode name> is the parameter used to select the mode with the INST:SEL command (for example, SA for the Spectrum Analyzer).

When you first enter this dialog, the path in the Save In: field depends on the data type. The only files

System Functions
Save

that are visible are the *.trace files and the Save As type is *.trace, since .trace is the file suffix for the Trace Save Type.

Key Path	Save, Trace (+State)
Mode	SA
Notes	Brings up the Save As dialog for saving a Trace Save Type
Initial S/W Revision	Prior to A.02.00

Save

This key initiates the save of the .trace file. All of the State of the currently active mode plus the system level Input/Output settings are saved to the specified file as well as all of the trace data, including internal flags set in the file indicating which trace is to be saved.

While the save is being performed, the floppy icon shows up in the settings bar near the Continuous/Single sweep icon. After the save completes, the Advisory Event "File <register number> saved" is displayed.

Key Path	Save, Trace, Save As...
Mode	SA
Remote Command	:MMEMory:STORe:TRACe TRACE1 TRACE2 TRACE3 TRACE4 TRACE5 TRACE6 ALL, <filename > :MMEMory:STORe:TRACe:REGister TRACE1 TRACE2 TRACE3 TRACE4 TRACE5 TRACE6 ALL, <integer>
Example	:MMEM:STOR:TRAC TRACE1, "myState.trace" saves the file myState.trace on the default path and flags it as a "single trace" file with Trace 1 as the single trace (even though all of the traces are in fact stored). :MMEM:STOR:TRAC ALL, "myState.trace" saves the file myState.trace on the default path and flags it as an "all traces" file :MMEM:STOR:TRAC:REG TRACE1,2 stores trace 1 data in trace register 2
Notes	Some modes and measurements do not have available all 6 traces. The Phase Noise mode command, for example, is: MMEMory:STORe:TRACe TRACE1 TRACE2 TRACE3 ALL,<filename> This command actually performs a save state, which in the Swept SA measurement includes the trace data. However it flags it (in the file) as a "save trace" file of the specified trace (or all traces). The range for the register parameter is 1-5 If the file already exists, the file will be overwritten. Using the C: drive is strongly discouraged, since it runs the risk of being overwritten during a instrument software upgrade. Both single and double quotes are supported for any filename parameter over remote. Auto return to the State menu and the Save As dialog goes away.

Initial S/W Revision	Prior to A.02.00
----------------------	------------------

Data (Export)

Exporting a data file stores data from the current measurement to mass storage files. The Export Menu only contains data types that are supported by the current measurement.

Since the commonly exported data files are in .csv format, the data can be edited by you prior to importing. This allows you to export a data file, manipulate the data in Excel (the most common PC Application for manipulating .csv files) and then import it.

Selecting an Export Data menu key will not actually cause the exporting to occur, since the analyzer still needs to know where you wish to save the data. Pressing the Save As key in this menu brings up the Save As dialog and Save As menu that allows you to specify the destination file and directory. Once a filename has been selected or entered in the Open menu, the export will occur as soon as the Save key is pressed.

Key Path	Save
Mode	All
Notes	The menu is built from whatever data types are available for the mode. So the key locations in the sub menu will vary. No SCPI command directly controls the Data Type that this key controls. The Data Type is included in the MMEM:STORe commands.
Dependencies	If a file type is not used by a certain measurement, that type is grayed out for that measurement. The key for a file type will not show at all if there are no measurements in the Mode that support it.
Preset	Is not affected by a Preset or shutdown, but is reset during Restore Mode Defaults
Readback	The data type that is currently selected
Initial S/W Revision	Prior to A.02.00

Trace

Enables you to select Traces as the data type to be exported. Pressing this key when it is already selected brings up the Trace menu, which allows you to select which Trace to save.

The trace file contains “meta” data, which describes the current state of the analyzer.

Key Path	Save, Data
Remote Command	:MMEMory:STORe:TRACe:DATA TRACE1 TRACE2 TRACE3 TRACE4 TRACE5 TRACE6 ALL, <filename >

Example	:MMEM:STOR:TRAC:DATA TRACE2,"myTrace2.csv" exports the 2nd trace to the file myTrace2.csv in the current path. The default path is My Documents\SA\data\traces VSA Example: MMEM:STOR:TRAC:DATA TRACE1,"Trc1.txt",TXT,ON
Notes	If the save is initiated via SCPI, and the file already exists, the file will be overwritten. Using the C: drive is strongly discouraged, since it runs the risk of being overwritten during an instrument software upgrade. Both single and double quotes are supported for any filename parameter over SCPI.
Dependencies	Trace data is not available from all Measurements. When unavailable, the key will be grayed out. The key will not show if no measurements in the Mode support it.
Readback	Swept SA: 1 2 3 4 5 6 ALL Analog Demod Mode: RF Spectrum Demod Demod Ave Demod Max Demod Min AF Spectrum Vector Signal Analyzer: Trace 1 Trace 2 with header Trace 2 Trace 2 with header Trace 3 Trace 3 with header Trace 4 Trace 4 with header Trace 5 Trace 5 with header Trace 6 Trace 6 with header
Instrument S/W Revision	Prior to A.02.00

Trace selection

Enables you to select which Trace to save. The traces may have names, or they may be labeled 1, 2, 3, 4, 5, or 6, depending on the current mode. Once selected, the key returns back to the Export Data menu and the selected trace name/number is annotated on the key. The default is the currently selected trace, selected in this menu or in the Trace/Det, Import Data, Recall Trace or Save Trace menus. The exception is, if you have chosen All then it remains chosen until you specifically change it to a single trace.

To trigger a save of the selected trace, you must select the Save As key in the Export Data menu.

Some measurements have an "ALL" selection. This saves all six traces in one .csv file with the x-axis data in the first column and the individual trace data in succeeding columns. The header data and x-axis data in this file reflect the current settings of the measurement. Note that any traces which are in View or Blank may have different x-axis data than the current measurement settings, but this data will not be output to the file.

Key Path	Save, Data, Trace
Mode	SA Analog Demod VSA
Preset	The first trace key shown.
Instrument S/W Revision	Prior to A.02.00

Include Header

The trace header information includes enough state information to display the trace data with the same

formatting and scaling when it is recalled. However, no other instrument state information is saved. If headers are not saved, the scaling and format are set to defaults when the trace is recalled.

Key Path	Save, Data, Trace
Example	MMEM:STOR:TRAC:DATA TRACE1,"Trc1.txt",TXT,ON The On/Off setting is the last variable passed in the MMEMory:STORe:TRACe:DATA command.
Mode	VSA
Preset	On
Instrument S/W Revision	Prior to A.02.00

Measurement Results

Different types of results are available for each particular measurement. The results that are available are documented under the individual measurements. These measurement results are the same as the results that are returned when using the MEASure:<measurement> command (usually for sub-opcode 1).

Measurement results may not be available for all measurements.

Key Path	Save, Data
Example	MMEM:STOR:RES "MyResultsFile.xml" This stores the measurement results data in the file MyResultsFile.xml in the default directory.
Mode	SA ADEMOD BASIC(IQ Analyzer) CDMA2K GSMEDGE PNOISE WCDMA WIMAXOFDMA TDS CDMA
Notes	The key will not show if no measurements in the Mode support it.
Instrument S/W Revision	Prior to A.02.00

Capture Buffer

Capture Buffer functionality is not available for all measurements. The captured data is raw data (unprocessed).

Key Path	Save, Data
Example	MMEM:STOR:CAPT "MyCaptureData.bin" This stores the capture data in the file MyCaptureData.bin in the default directory.
Mode	WCDMA
Notes	The key will not show if no measurements in the Mode support it.
Instrument S/W Revision	Prior to A.02.00

Zone map

A map file contains zone definitions that will help simplify making measurements of frequently used signals. The OFDMA frame structure can contain multiple-zone definitions for the uplink and downlink subframes and multiple data burst allocations. You can store map files in which you have saved complicated OFDMA frame analysis zone definitions. This can save you time and ensure the accuracy of repeated measurements. map files are also useful for recreating measurement settings so they can be used by other users.

Key Path	Save, Data
Example	MMEM:STOR:ZMAP "MyZonemapFile.omf" This stores the zone map data in the file MyZonemapFile.omf in the default directory.
Mode	OFDMA WiMAX
Notes	The key will not show if no measurements in the Mode support it.
Instrument S/W Revision	Prior to A.02.00

Recorded Data

Saving recorded data is not available for all measurements. Recorded data, and the optional header info, may be recalled later (or transferred to another instrument) for analysis.

This function is available in 89601X VSA Option 200, but not in Option 205.

Key Path	Save, Data (Export)
Example	MMEM:STOR:REC "MyRecording.sdf",SDF,ON,ON,OFF
Mode	VSA
Notes	Grayed out unless there is recorded data in the buffer.
Instrument S/W Revision	Prior to A.02.00

Save As . . .

This menu lets you select the location where you can save Data Type files. It is a standard Windows® dialog with Save As menu keys. The "File Name" field in the Save As dialog is initially loaded with an automatically generated filename specific to the appropriate Save Type. The automatically generated filename is guaranteed not to conflict with any filename currently in the directory. You may replace or modify this filename using the File Name key. See the Quick Save key documentation for more on the automatic file naming algorithm.

When you first enter this dialog, the path in the Save In: field depends on the data type. The only files that are visible are the files with the corresponding data type suffix, and the **Save As** type lists the same suffix.

For example, if the Data Type is **Amplitude Corrections**, the file suffix is .csv and the *.csv files are the only visible files in the **Save As** dialog and .csv is the Save As Type.

The default path for saving files is:

For all of the Trace Data Files:

My Documents\<<mode name>\data\traces

For all of the Limit Data Files:

My Documents\<<mode name>\data\limits

For all of the Measurement Results Data Files:

My Documents\<<mode name>\data\<<measurement name>\results

For all of the Capture Buffer Data Files:

My Documents\<<mode name>\data\captureBuffer

Key Path	Save, Data
Mode	All
Notes	The key location is mode-dependent and will vary. Brings up the Save As dialog for saving a <mode specific> Save Type
Initial S/W Revision	Prior to A.02.00

Save

Saves the specified Data Type. This section describes any specific save behavior relevant to Data that is common to all modes.

When a Save of a specific Data File is requested, the specified data is saved to the specified or selected file. The save is performed immediately and does not wait until the measurement is complete.

If the file already exists, a dialog will appear that allows you to replace the existing file by selecting **OK** or you can **Cancel** the request.

While the save is being performed, the floppy icon will show up in the settings bar near the Continuous/Single icon. After a register save completes, the corresponding register softkey annotation is updated with the date the time and an advisory message that the file was saved appears in the message bar.

Key Path	Save, Data, Save As...
Notes	If the file already exists, the file will be overwritten. Using the C: drive is strongly discouraged, since it runs the risk of being overwritten during a instrument software upgrade. Both single and double quotes are supported for any filename parameter over remote.
Initial S/W Revision	Prior to A.02.00

Screen Image

Accesses a menu of functions that enable you to specify a format and location for the saved screen image.

Pressing Screen Image brings up a menu that allows you to specify the color scheme of the Screen Image

System Functions

Save

(Themes) or navigate to the Save As dialog to perform the actual save.

Screen Image files contain an exact representation of the analyzer display. They cannot be loaded back onto the analyzer, but they can be loaded into your PC for use in many popular applications.

The image to be saved is actually captured when the **Save** front panel key is pressed, and kept in temporary storage to be used if the user asks for a Screen Image save. When the Screen Image softkey is pressed, a "thumbnail" of the captured image is displayed, as shown below:

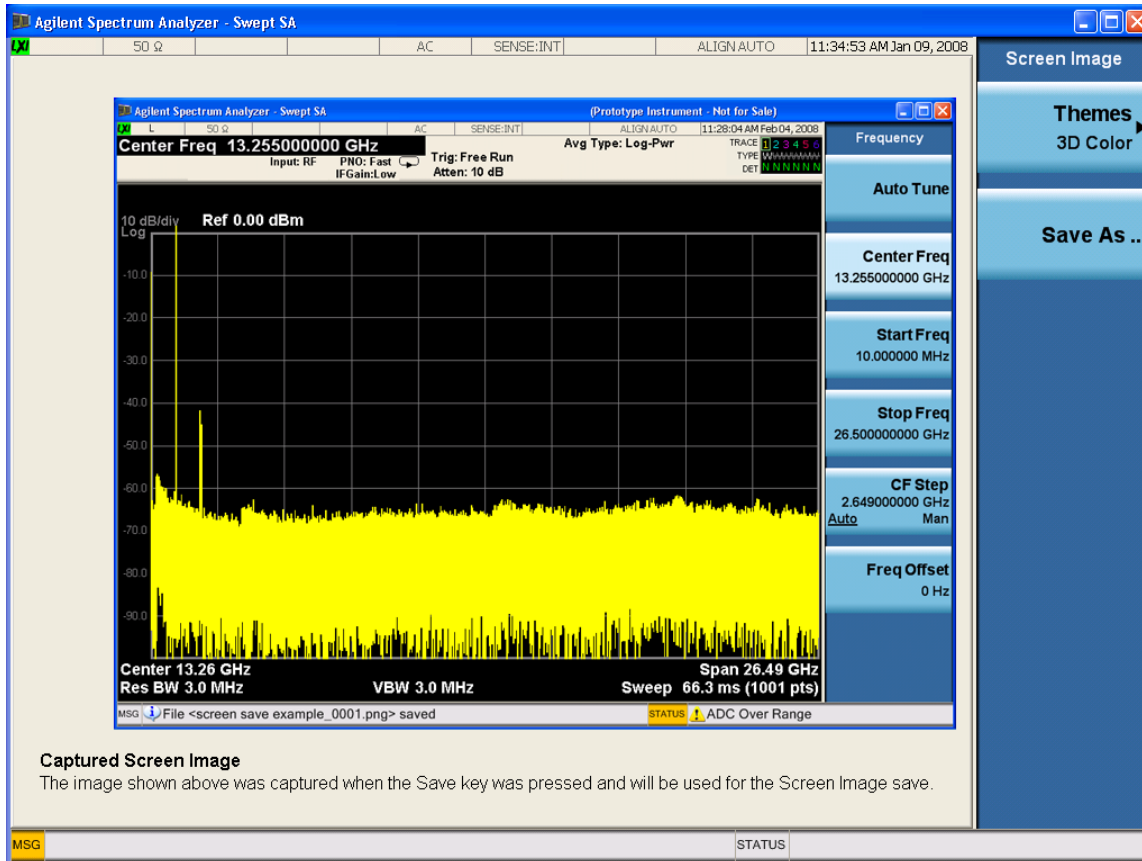

When you continue on into the **Save As** menu and complete the Screen Image save, the image depicted in the thumbnail is the one that gets saved, showing the menus that were on the screen before going into the **Save** menus.

After you have completed the save, the **Quick Save** front-panel key lets you quickly repeat the last save performed, using an auto-named file, with the current screen data.

NOTE For versions previous to A.01.55, if you initiate a screen image save by navigating through the Save menus, the image that is saved will contain the Save menu softkeys, not the menus and the active function that were on the screen when you first pressed the Save front panel key.

Key Path	Save
----------	------

Mode	All
Example	MMEM:STOR:SCR "MyScreenFile.png" This stores the current screen image in the file MyScreenFile.png in the default directory.
Notes	See
Initial S/W Revision	Prior to A.02.00

Themes

Accesses a menu of functions that enable you to choose the theme to be used when saving the screen image.

The **Themes** option is the same as the **Themes** option under the **Display** and **Page Setup** dialogs. It allows you to choose between themes to be used when saving the screen image.

Key Path	Save, Screen Image
Remote Command	:MMEMory:STORe:SCREen:THEMe TDCOLOR TDMonochrome FCOLOR FMONochrome :MMEMory:STORe:SCREen:THEMe?
Example	:MMEM:STOR:SCR:THEM TDM
Preset	3D Color; Is not part of Preset, but is reset by Restore Misc Defaults or Restore System Defaults All and survives subsequent running of the modes.
Readback	3D Color 3D Mono Flat Color Flat Mono
Initial S/W Revision	Prior to A.02.00

3D Color

Selects a standard color theme with each object filled, shaded and colored as designed.

Key Path	Save, Screen Image, Themes
Example	MMEM:STOR:SCR:THEM TDC
Readback	3D Color
Initial S/W Revision	Prior to A.02.00

3D Monochrome

Selects a format that is like 3D color but shades of gray are used instead of colors.

Key Path	Save, Screen Image, Themes
Example	MMEM:STOR:SCR:THEM TDM
Readback	3D Mono

System Functions

Save

Initial S/W Revision	Prior to A.02.00
----------------------	------------------

Flat Color

Selects a format that is best when the screen is to be printed on an ink printer.

Key Path	Save, Screen Image, Themes
Example	MMEM:STOR:SCR:THEM FCOL
Readback	Flat Color
Initial S/W Revision	Prior to A.02.00

Flat Monochrome

Selects a format that is like Flat Color. But only black is used (no colors, not even gray), and no fill.

Key Path	Save, Screen Image, Themes
Example	MMEM:STOR:SCR:THEM FMON
Readback	Flat Mono
Initial S/W Revision	Prior to A.02.00

Save As...

Accesses a menu that enables you to select the location where you can save the Screen Image. This menu is a standard Windows® dialog with Save As menu keys. The **Save As** dialog is loaded with the file information related to the Screen Image Type. The filename is filled in using the auto file naming algorithm for the Screen Image Type and is highlighted. The only files that are visible are the *.png files and the Save As Type is *.png, since .png is the file suffix for the Screen Image Type.

The default path for Screen Images is

My Documents\`<mode name>`\screen.

where `<mode name>` is the parameter used to select the mode with the INST:SEL command (for example, SA for the Spectrum Analyzer).

This path is the **Save In:** path in the **Save As** dialog for all Screen Files when you first enter this dialog.

Key Path	Save, Screen Image
Notes	Brings up Save As dialog for saving a Screen Image Save Type
Initial S/W Revision	Prior to A.02.00

Save

Saves the screen image to the specified file using the selected theme. The image that is saved is the measurement display prior to when the **Save As** dialog appeared. The save is performed immediately

and does not wait until the measurement is complete.

Key Path	Save, Screen Image, Save As...
Remote Command	:MMEMory:STORe:SCReen <filename>
Example	:MMEM:STOR:SCR "myScreen.png"
Notes	<p>If the file already exists, the file will be overwritten. Using the C: drive is strongly discouraged, since it runs the risk of being overwritten during a instrument software upgrade. Both single and double quotes are supported for any filename parameter over remote.</p> <p>Auto return to the Screen Image menu and the Save As dialog goes away.</p> <p>Advisory Event "File <file name> saved" after save is complete.</p>
Initial S/W Revision	Prior to A.02.00

Save As . . .

Accesses a standard Windows dialog with the **Save As** key menu. The "File Name" field in the Save As dialog is initially loaded with an automatically generated filename specific to the appropriate Save Type. The automatically generated filename is guaranteed not to conflict with any filename currently in the directory. You may replace or modify this filename using the File Name key. See the Quick Save key documentation for more on the automatic file naming algorithm.

The **Save As** dialog has the last path loaded in **Save In:** for this particular file type. User specified paths are remembered and persist through subsequent runs of the mode. These remembered paths are mode specific and are reset back to the default using **Restore Mode Defaults**.

Initial S/W Revision:	Prior to A.02.00
-----------------------	------------------

Save

Performs the actual save to the specified file of the selected type. The act of saving does not affect the currently running measurement and does not require you to be in single measurement mode to request a save. It performs the save as soon as the currently running measurement is in the idle state; when the measurement completes. This ensures the State or Data that is saved includes complete data for the current settings. The save only waits for the measurement to complete when the state or data that depends on the measurement setup is being saved. The save happens immediately when exporting corrections or when saving a screen image.

If the file already exists, a dialog appears with corresponding menu keys that allow you to replace the existing file with an **OK** or to **Cancel** the request.

While the save is being performed, the floppy icon shows up in the settings bar near the Continuous/Single icon. After the save completes, the corresponding register menu key annotation is

System Functions

Save

updated with the date the time and the message "File <file name> saved" appears in the message bar.

Notes	If the file already exists, the File Exist dialog appears and allows you to replace it or not by selecting the Yes or No menu keys that appear with the dialog. Then the key causes an auto return and Save As dialog goes away. Advisory Event "File <file name> saved" after save is complete.
Initial S/W Revision	Prior to A.02.00

File/Folder List

Enables you to navigate to the center of the dialog that contains the list of files and folders. Once here you can get information about the file.

Key Path	Save, <various>, Save As...
Notes	Pressing this key enables you to navigate to the files and folders list in the center of the dialog.
Initial S/W Revision	Prior to A.02.00

File Name

Accesses the Alpha Editor. Use the knob to choose the letter to add and the Enter front-panel key to add the letter to the file name. In addition to the list of alpha characters, this editor includes a **Space** key and a **Done** key. The **Done** key completes the filename, removes the Alpha Editor and returns back to the **File Open** dialog and menu, but does not cause the save to occur. You can also use **Enter** to complete the file name entry and this will cause the save to occur.

Key Path	Save, <various>, Save As...
Notes	Brings up the Alpha Editor. Editor created file name is loaded in the File name field of the Save As dialog.
Initial S/W Revision	Prior to A.02.00

Save As Type

This key corresponds to the **Save As Type** selection in the dialog. It follows the standard Windows® supported **Save As Type** behavior. It shows the current file suffix that corresponds to the type of file you have selected to save. If you navigated here from saving State, "State File (*.state)" is in the dialog selection and is the only type available under the pull down menu. If you navigated here from saving Trace, "Trace+State File (*.trace)" is in the dialog selection and is the only type available under the pull down menu. If you navigated here from exporting a data file, "Data File (*.csv)" is in the dialog and is available in the pull down menu. Modes can have other data file types and they would also be listed in the pull down menu.

Key Path	Save, <various>, Save As...
Notes	Pressing this key causes the pull down menu to list all possible file types available in this context. All types available are loaded in a 1-of-N menu key for easy navigation.

Initial S/W Revision	Prior to A.02.00
----------------------	------------------

Up One Level

This key corresponds to the icon of a folder with the up arrow that is in the tool bar of the dialog. It follows the standard Windows® supported **Up One Level** behavior. When pressed, it causes the file and folder list to navigate up one level in the directory structure.

Key Path	Save, <various>, Save As...
Notes	When pressed, the file and folder list is directed up one level of folders and the new list of files and folders is displayed
Initial S/W Revision	Prior to A.02.00

Create New Folder

This key corresponds to the icon of a folder with the "*" that is in the tool bar of the dialog. It follows the standard Windows® supported **Create New Folder** behavior. When pressed, a new folder is created in the current directory with the name **New Folder** and allows you to enter a new folder name using the Alpha Editor.

Key Path	Save, <various>, Save As...
Notes	Creates a new folder in the current folder and lets the user fill in the folder name using the Alpha Editor.
Initial S/W Revision	Prior to A.02.00

Cancel

This key corresponds to the **Cancel** selection in the dialog. It follows the standard Windows supported **Cancel** behavior. It causes the current **Save As** request to be cancelled.

Key Path	Save, <various>, Save As...
Notes	Pressing this key causes the Save As dialog to go away and auto return.
Initial S/W Revision	Prior to A.02.00

Mass Storage Catalog (Remote Command Only)

Remote Command:	:MMEMory:CATalog? [<directory_name>]
Notes:	<p>The string must be a valid logical path.</p> <p>Query disk usage information (drive capacity, free space available) and obtain a list of files and directories in a specified directory in the following format:</p> <p><numeric_value>,<numeric_value>,{<file_entry>}</p> <p>It shall return two numeric parameters and as many strings as there are files and directories. The first parameter shall indicate the total amount of storage currently used in bytes. The second parameter shall indicate the total amount of storage available, also in bytes. The <file_entry> is a string. Each <file_entry> shall indicate the name, type, and size of one file in the directory list:</p> <p><file_name>,<file_type>,<file_size></p> <p>As windows file system has an extension that indicates file type, <file_type> is always empty. <file_size> provides the size of the file in bytes. In case of directories, <file_entry> is surrounded by square brackets and both <file_type> and <file_size> are empty.</p>
Initial S/W Revision:	Prior to A.02.00

Mass Storage Change Directory (Remote Command Only)

Remote Command:	:MMEMory:CDIRectory [<directory_name>] :MMEMory:CDIRectory?
Notes:	<p>The string must be a valid logical path.</p> <p>Changes the default directory for a mass memory file system. The <directory_name> parameter is a string. If no parameter is specified, the directory is set to the *RST value.</p> <p>At *RST, this value is set to the default user data storage area, that is defined as System.Environment.SpecialFolder.Personal.</p> <p>Query returns full path of the default directory.</p>
Initial S/W Revision:	Prior to A.02.00

Mass Storage Copy (Remote Command Only)

Remote Command:	:MMEMory:COPY <string>,<string>[,<string>,<string>]
------------------------	---

Notes:	<p>The string must be a valid logical path.</p> <p>Copies an existing file to a new file or an existing directory to a new directory.</p> <p>Two forms of parameters are allowed. The first form has two parameters. In this form, the first parameter specifies the source, and the second parameter specifies the destination.</p> <p>The second form has four parameters. In this form, the first and third parameters specify the source. The second and fourth parameters specify the directories. The first pair of parameters specifies the source. The second pair specifies the destination. An error is generated if the source doesn't exist or the destination file already exists.</p>
--------	---

Mass Storage Delete (Remote Command Only)

Remote Command:	:MMEMory:DELeTe <file_name>[,<directory_name>]
Notes:	<p>The string must be a valid logical path.</p> <p>Removes a file from the specified directory. The <file_name> parameter specifies the file name to be removed.</p>
Initial S/W Revision:	Prior to A.02.00

Mass Storage Data (Remote Command Only)

Creates a file containing the specified data OR queries the data from an existing file.

Remote Command:	:MMEMory:DATA <file_name>, <data> :MMEMory:DATA? <file_name>
Notes:	<p>The string must be a valid logical path.</p> <p>The command form is MMEMory:DATA <file_name>,<data>. It loads <data> into the file <file_name>. <data> is in 488.2 block format. <file_name> is string data.</p> <p>The query form is MMEMory:DATA? <file_name> with the response being the associated <data> in block format.</p>
Initial S/W Revision:	Prior to A.02.00

Mass Storage Make Directory (Remote Command Only)

Remote Command:	:MMEMory:MDIRectory <directory_name>
Notes:	The string must be a valid logical path. Creates a new directory. The <directory_name> parameter specifies the name to be created.
Initial S/W Revision:	Prior to A.02.00

Mass Storage Move (Remote Command Only)

Remote Command:	:MMEMory:MOVE <string>,<string> [, <string>,<string>]
Notes:	The string must be a valid logical path. Moves an existing file to a new file or an existing directory to a new directory. Two forms of parameters are allowed. The first form has two parameters. In this form, the first parameter specifies the source, and the second parameter specifies the destination. The second form has four parameters. In this form, the first and third parameters specify the source. The second and fourth parameters specify the directories. The first pair of parameters specifies the source. The second pair specifies the destination. An error is generated if the source doesn't exist or the destination file already exists.
Initial S/W Revision:	Prior to A.02.00

Mass Storage Remove Directory (Remote Command Only)

Remote Command:	:MEMMory:RDIRectory <directory_name>
Notes:	The string must be a valid logical path. Removes a directory. The <directory_name> parameter specifies the directory name to be removed. All files and directories under the specified directory shall also be removed.
Initial S/W Revision:	Prior to A.02.00

System

Opens a menu of keys that access various configuration menus and dialogs.

Key Path	Front-panel key
Notes	No remote command for this key specifically.
Initial S/W Revision	Prior to A.02.00

Show

Accesses a menu of choices that enable you to select the information window you want to view.

Key Path	System
Mode	All
Remote Command	:SYSTem:SHOW OFF ERRor SYSTem HARDware LXI HWSTatistics ALIGNment SOFTware CAPPLication :SYSTem:SHOW?
Example	:SYST:SHOW SYST
Notes	This command displays (or exits) the various System information screens.
Preset	OFF
State Saved	No
Range	OFF ERRor SYSTem HARDware LXI HWSTatistics ALIGNment SOFTware CAPPLication
Initial S/W Revision	Prior to A.02.00

Errors

There are two modes for the Errors selection, History and Status.

The list of errors displayed in the Errors screen does not automatically refresh. You must press the Refresh key or leave the screen and return to it to refresh it.

History brings up a screen displaying the event log in chronological order, with the newest event at the top. The history queue can hold up to 100 messages (if a message has a repeat count greater than 1 it only counts once against this number of 100). Note that this count bears no relation to the size of the SCPI queue. If the queue extends onto a second page, a scroll bar appears to allow scrolling with a mouse. Time is displayed to the second.

Status brings up a screen summarizing the status conditions currently in effect. Note that the time is displayed to the second.

The fields on the Errors display are:

System Functions
System

Type (unlabelled) - Displays the icon identifying the event or condition as an error or warning.

ID - Displays the error number.

Message - Displays the message text.

Repeat (RPT) - This field shows the number of consecutive instances of the event, uninterrupted by other events. In other words, if an event occurs 5 times with no other intervening event, the value of repeat will be 5.

If the value of Repeat is 1 the field does not display. If the value of Repeat is >1, the time and date shown are those of the most recent occurrence. If the value of repeat reaches 999,999 it stops there.

Time - Shows the most recent time (including the date) at which the event occurred.

Key Path	System, Show
Mode	All
Remote Command	:SYSTem:ERRor [:NEXT] ?
Example	:SYST:ERR?
Notes	The return string has the format: “<Error Number>,<Error>” Where <Error Number> and <Error> are defined in the Master Error Messages document.
State Saved	No
Initial S/W Revision	Prior to A.02.00

Next Page

Next Page and Previous Page menu keys move you between pages of the log, if it fills more than one page. These keys are grayed out in some cases:

- If on the last page of the log, the Next Page key is grayed out
- If on the first page of the log, the Previous Page key is grayed out.
- If there is only one page, both keys are grayed out.

Key Path	System, Show, Errors
Initial S/W Revision	Prior to A.02.00

Previous Page

See “Next Page” on page 192.

Key Path	System, Show, Errors
Initial S/W Revision	Prior to A.02.00

History

The History and Status keys select the Errors view. The Status key has a second line which shows a number in [square brackets]. This is the number of currently open status items.

Key Path	System, Show, Errors
Initial S/W Revision	Prior to A.02.00

Status

See “History” on page 193

Verbose SCPI On/Off

This is a capability that will allow the SCPI data stream to be displayed when a SCPI error is detected, showing the characters which stimulated the error and several of the characters preceding the error.

Key Path	System, Show, Errors
Mode	All
Remote Command	:SYSTem:ERRor:VERBoSe OFF ON 0 1 :SYSTem:ERRor:VERBoSe?
Example	:SYST:ERR:VERB ON
Preset	OFF
Preset	This is unaffected by Preset but is set to OFF on a “Restore System Defaults->Misc”
State Saved	No
Range	On Off
Initial S/W Revision	Prior to A.02.00

Refresh

When pressed, refreshes the Show Errors display.

Key Path	System, Show, Errors
Initial S/W Revision	Prior to A.02.00

Clear Error Queue

This clears all errors in all error queues.

Note the following:

Clear Error Queue does not affect the current status conditions.

Mode Preset does not clear the error queue.

Restore System Defaults will clear all error queues.

System Functions

System

*CLS only clears the queue if it is sent remotely and *RST does not affect any error queue.

Switching modes does not affect any error queues.

Key Path	System, Show, Errors
Initial S/W Revision	Prior to A.02.00

System

The System screen is formatted into three groupings: product descriptive information, options tied to the hardware, and software products:

<Product Name> <Product Description>		
Product Number: N9020A		
Serial Number: US46220924		
Firmware Revision: A.01.01		
Computer Name: <hostname>		
Host ID: N9020A,US44220924		
N9020A-503	Frequency Range to 3.6 GHz	
N9020A-PFR	Precision Frequency Reference	
N9020A-P03	Preamp 3.6 GHz	
N9060A-2FP	Spectrum Analysis Measurement Suite	1.0.0.0
N9073A-1FP	WCDMA	1.0.0.0
N9073A-2FP	WCDMA with HSDPA	1.0.0.0

The Previous Page is grayed-out if the first page of information is presently displayed. The Next Page menu key is grayed-out if the last page is information is presently displayed.

Key Path	System, Show
Mode	All
Example	SYST:SHOW SYST
Initial S/W Revision	Prior to A.02.00

Hardware

The show hardware screen is used to view details of the installed hardware. This information can be used to determine versions of hardware assemblies and field programmable devices, in the advent of future upgrades or potential repair needs.

The screen is formatted into two groupings: product descriptive information and hardware information. The hardware information is listed in a table format:

System Functions

System

- The date the event occurred (GMT)
- The time the event occurred (GMT)
- The type of event: LAN Input, LAN Output, Status, Alarm, Trigger Alarm, Trigger LAN
- The name of the event
- The edge associated with the event
- The event's identifier: This is the string that appears on the LAN.
- The source event: This is only valid for LAN Output, Trigger LAN, and Trigger Alarm event types.
- The source address: This is only valid for LAN Input event types. It is the address from which the message originated.
- The destination address: This is only valid for LAN Output event types. It is the address (or addresses) that the message will be sent to. For UDP messages, this field reads "ALL."

Key Path	System, Show, LXI
Initial S/W Revision	Prior to A.02.00

Next Page

See ["Next Page" on page 192.](#)

Key Path	System, Show, Errors
Initial S/W Revision	Prior to A.02.00

Previous Page

See ["Next Page" on page 192](#)

Key Path	System, Show, Errors
Initial S/W Revision	Prior to A.02.00

Circular

Sets the behavior for entries that occur while the LXI Event Log is full.

- If Circular is set to 1, incoming events overwrite the oldest events in the log.
- If Circular is set to 0, incoming events are discarded.

Key Path	System, Show, LXI, LXI Event Log
Remote Command	:LXI:EVENT:LOG:CIRCular[:ENABLE] ON OFF 1 0 :LXI:EVENT:LOG:CIRCular[:ENABLE]?
Example	:LXI:EVEN:LOG:CIRC 1
Preset	ON

Preset	Not affected by a Preset. The default value of "ON" can be restored by pressing System, Restore Defaults, Misc.
State Saved	Saved in instrument state.
Range	OFF ON 0 1
Initial S/W Revision	Prior to A.02.00

Clear

Clears the event log of all entries.

Key Path	System, Show, LXI, LXI Event Log
Remote Command	:LXI:EVENT:LOG:CLEar
Example	:LXI:EVEN:LOG:CLE
Initial S/W Revision	Prior to A.02.00

Size

Sets the maximum number of entries the LXI Event Log can hold.

Key Path	System, Show, LXI, LXI Event Log
Remote Command	:LXI:EVENT:LOG:SIZE <size> :LXI:EVENT:LOG:SIZE?
Example	:LXI:EVEN:LOG:SIZE 256
Preset	64
Preset	Not affected by a Preset. The default value of "64" can be restored by pressing System, Restore Defaults, Misc.
State Saved	Saved in instrument state.
Range	>= 0
Initial S/W Revision	Prior to A.02.00

Enabled

Enables and disables the logging of LXI Events.

Key Path	System, Show, LXI, LXI Event Log
Remote Command	:LXI:EVENT:LOG:ENABle ON OFF 1 0 :LXI:EVENT:LOG:ENABle?
Example	:LXI:EVEN:LOG:ENAB ON
Preset	ON

System Functions
System

Preset	Not affected by a Preset. The default value of "ON" can be restored by pressing System, Restore Defaults, Misc.
State Saved	Saved in instrument state.
Range	ON OFF 0 1
Initial S/W Revision	Prior to A.02.00

Count (Remote Command Only)

Returns the number of entries currently in the LXI Event Log.

Remote Command	:LXI:EVENT:LOG:COUNT?
Example	:LXI:EVEN:LOG:COUN?
Range	0 – Size
Initial S/W Revision	Prior to A.02.00

Next Entry (Remote Command Only)

Returns the oldest entry from the LXI Event Log and removes it from the log. If the log is empty, an empty string is returned.

Remote Command	:LXI:EVENT:LOG[:NEXT]?
Example	:LXI:EVEN:LOG?
Initial S/W Revision	Prior to A.02.00

All (Remote Command Only)

Non-destructively retrieves the entire contents of the event log. Entries are returned as separate strings, surrounded by double quote marks, and separated by a comma. Fields within each entry are also comma delimited.

Remote Command	:LXI:EVENT:LOG:ALL?
Example	:LXI:EVEN:LOG:ALL? Returns the entire event log contents. An example may look like the following: "11/12/2007,18:14:10.770385,Error,LogOverwrite,Rise,,,,","11/12/2007,18:14:10.592105,Status,Measuring,Rise,,,,","11/12/2007,18:14:10.597758,Status,Measuring,Fall,,,,","11/12/2007,18:14:10.597786,Status,Sweeping,Fall,,,,","11/12/2007,18:14:10.599030,Status,WaitingForTrigger,Rise,,,," The contents of the Event Log vary, based on the operation of the instrument.
Initial S/W Revision	Prior to A.02.00

Specific Entry (Remote Command Only)

Non-destructively retrieves a specifically indexed entry from the event log. Fields within an entry are comma

delimited.

Remote Command	:LXI:EVENT:LOG:ENTRy? <intIndex>
Example	:LXI:EVEN:LOG:ENTR? 0 Returns the first entry in the event log. An example may look like the following: "11/12/2007,18:14:10.770385,Error,LogOverwrite,Rise,,," The contents of the Event Log vary, based on the operation of the instrument.
Initial S/W Revision	Prior to A.02.00

Beginning Entry (Remote Command Only)

Sets or freezes the beginning entry of the log when in circular mode to the most recently added entry at the time of the command. This is so that the :LXI:EVENT:LOG:ENTRy? command has a reference entry for indexing individual entries in the log.

Remote Command	:LXI:EVENT:LOG:CIRCular:FBENTry
Example	:LXI:EVEN:LOG:CIRC:FBEN
Initial S/W Revision	Prior to A.02.00

Power On

Enables you to select how the instrument should power on. The options are: Mode and Input/Output Defaults, User Preset and Last State.

Key Path	System
Mode	All
Remote Command	:SYSTem: PON: TYPE MODE USER LAST PRESet :SYSTem: PON: TYPE?
Example	:SYST: PON: TYPE MODE
Preset	MODE
Preset	This is unaffected by a Preset but is set to Mode on a "Restore System Defaults->All"
State Saved	No
Initial S/W Revision	Prior to A.02.00

Mode and Input/Output Defaults

When the analyzer is powered on in Mode and Input/Output Defaults, it performs a Restore Mode Defaults to all modes in the instrument and also performs a Restore Input/Output Defaults.

Persistent parameters (such as Amplitude Correction tables or Limit tables) are not affected at poweron,

even though they are normally cleared by Restore Input/Output Defaults and/or Restore Mode Defaults.

Key Path	System, Power On
Mode	All
Example	SYST:PON:TYPE MODE
Readback Text	Defaults
Initial S/W Revision	Prior to A.02.00

User Preset

Sets **Power On to User Preset**. When the analyzer is powered on in User Preset, it will User Preset each mode and switch to the power-on mode. Power On User Preset will not affect any settings beyond what a normal User Preset affects.

NOTE An instrument could never power up for the first time in User Preset.

Key Path	System, Power On
Mode	All
Example	SYST:PON:TYPE USER
Readback Text	User Preset
Initial S/W Revision	Prior to A.02.00

Last State

Sets **Power On to Last**. When the analyzer is powered on, it will put all modes in the last state they were in prior to when the analyzer was put into Power Standby and it will wake up in the mode it was last in prior to powering off the instrument. The saving of the active mode prior to shutdown happens behind the scenes when a controlled shutdown is requested by using the front panel power **Standby** key or by using the remote command `SYSTem:PDOWn`. The non-active modes are saved as they are deactivated and recalled by Power On Last State.

NOTE An instrument could never power up for the first time in Last.

If line power to the analyzer is interrupted, for example by pulling the line cord plug or by switching off power to a test rack, Power On Last State will not work properly.

Key Path	System, Power On
Mode	All

Example	SYST:PON:TYPE LAST
Notes	Power on Last State only works if the user has done a controlled shutdown prior to powering on in Last. If a controlled shutdown is not done when in Power On Last State, the instrument will power up in the last active mode, but it may not power up in the active mode's last state. If an invalid mode state is detected, a Mode Preset will occur. To control the shutdown under remote control use the :SYSTem:PDOWn command.
Readback Text	Last State
Initial S/W Revision	Prior to A.02.00

Power On Application

Accesses a menu that lists the available Modes and lets you select which Mode is to be the power-on application.

This application is used for Power On Type “Mode and Input/Output Defaults” and Restore System Defaults All.

Key Path	System, Power On
Mode	All
Remote Command	:SYSTem: PON: MODE SA BASIC ADEMOD NFIGURE PNOISE CDMA2K TDSCDMA VSA VSA89 601 WCDMA WIMAXOFDMA :SYSTem: PON: MODE?
Example	SYST:PON:MODE SA
Notes	The list of possible modes (and remote parameters) to choose from is dependent on which modes are installed in the instrument.
Preset	SA
Preset	This is unaffected by a Preset but is set on a “Restore System Defaults->All” to SA.
State Saved	No
Initial S/W Revision	Prior to A.02.00

Configure Applications

The Configure Applications utility lets you do two things:

1. specify a subset of the available applications (Modes) to preload into memory at startup time
2. specify the order in which the Modes appear in the Mode menu

There are several reasons you might want to specify a subset of the available applications (Modes) to preload:

- During runtime, if a Mode which is not preloaded is selected by the user, there will be a pause while the Application is loaded. Configure Applications lets you decide whether you want that delay at

startup of the analyzer program or the first time you select the Mode.

- In addition, there are more applications available for the X-Series than can fit into Windows Virtual Memory. The Configure Application utility allows you to choose which licensed applications to load into memory, if you have more licensed than can fit.

The Configure Applications utility can be used to select applications for preload and/or to determine how many applications can fit in memory at one time. This utility consists of a window with instructions, a set of “Select Application” checkboxes, a “fuel bar” style memory gauge, and softkeys that help you set up your configuration.

Preloading Applications

During operation of the analyzer, you select applications from the Mode menu. After startup of the analyzer program, the first time you select a particular application that application must be loaded into memory. Once loaded, the application stays loaded, so the next time you select it during a session, there is no delay. During runtime, if an application which is not yet loaded into memory is selected using the Mode menu or sending SCPI commands, there will be a pause while the Application is loaded. During this pause a message which says “Loading application, please wait ...” is displayed.

You can use the Configure Applications utility to choose applications to “preload” at startup, to eliminate the runtime delay; if you do this, the delay will instead increase the time it takes to start up the analyzer program, but for many users this is preferable to having to wait the first time they select an application. Asking for an application to be preloaded will cause it to be loaded into the analyzer’s memory when the analyzer program starts up. Once it is loaded into memory, it cannot be unloaded without exiting and restarting the analyzer program.

Virtual memory usage

There are more applications available for the X-Series than can fit into memory at any one time, so the Configure Applications utility includes a memory tracker that serves two purposes:

1. It will not let you preload more applications than will fit into memory at once.
2. You can determine how many of your favorite applications can reside in memory at one time.

The utility provides a graphical representation of the amount of memory (note that the memory in question here is Virtual memory and is a limitation imposed by the operating system, not by the amount of physical memory you have in your analyzer). You select applications to preload by checking the boxes on the left. Checked applications preload at startup. The colored fuel bar indicates the total memory required when all the checked applications are loaded (either preloaded or selected during runtime).

Here is what the fuel bar colors mean:

RED: the applications you have selected cannot all fit into the analyzer’s memory. You must deselect applications until the fuel bar turns yellow.

YELLOW: the applications you have selected can all fit into the analyzer’s memory, but there is less than 10% of the memory left, probably not enough to load any other applications, either via preload or by selecting a Mode while the analyzer is running..

GREEN: The indicator is green when <90% of the memory limit is consumed. This means the applications you have selected can all fit into the analyzer’s memory with room to spare. You will likely be able to load one or more other applications without running out of memory.

Access to Configure Applications utility

You may, at any time, manually call up the Configure Applications utility by pressing **System, Power On, Configure Applications**, to find a configuration that works best for you, and then restart the analyzer program.

The utility may also be called if, during operation of the analyzer, you attempt to load more applications than can fit in memory at once.

A version of the utility also runs the first time you power up the analyzer after purchasing it from Agilent. In this case the utility automatically configures preloads so that as many licensed applications as possible are preloaded while keeping the total estimated virtual memory usage below the limit. This auto-configuration only takes place at the very first run, and after analyzer software upgrades.

Key Path	System, Power On
Example	:SYST:SHOW CAPP Displays the Config Applications screen
Initial S/W Revision	A.02.00

Select All

Marks all applications in the selection list. This allows you to enable all applications licensed on the instrument for pre-loading, or is a convenience for selecting all applications in one operation and then letting you deselect individual applications.

Key Path	System, Power On, Configure Applications
Initial S/W Revision	A.02.00

Deselect All

Clears the marks from all applications in the selection list, with the exception of the Power On application. The Power On application cannot be eliminated from the pre-load list.

Key Path	System, Power On, Configure Applications
Initial S/W Revision	A.02.00

Move Up

The application list is the order in which applications appear in the Mode Menu. This key enables you to shift the selected application up in the list, thus moving the selected application earlier in the Mode Menu.

Key Path	System, Power On, Configure Applications
Initial S/W Revision	A.02.00

Move Down

The application list is the order in which applications appear in the Mode Menu. This key enables you to shift the selected application down in the list, thus moving the selected application later in the Mode

Menu.

Key Path	System, Power On, Configure Applications
Initial S/W Revision	A.02.00

Select/Deselect

Toggles the currently highlighted application in the list.

Key Path	System, Power On, Configure Applications
Initial S/W Revision	A.02.00

Save Changes and Exit

Applies the configuration of the applications list. The marked applications will be pre-loaded in memory the next time the instrument application is started, and the order of the applications in the list will be the order of the applications in the Mode Menu.

After saving your changes, the analyzer asks you if you would like it to restart so that your changes can take effect (see dialog box, below). If you choose not to restart, no memory will be released until the next time you shut down and restart the analyzer.

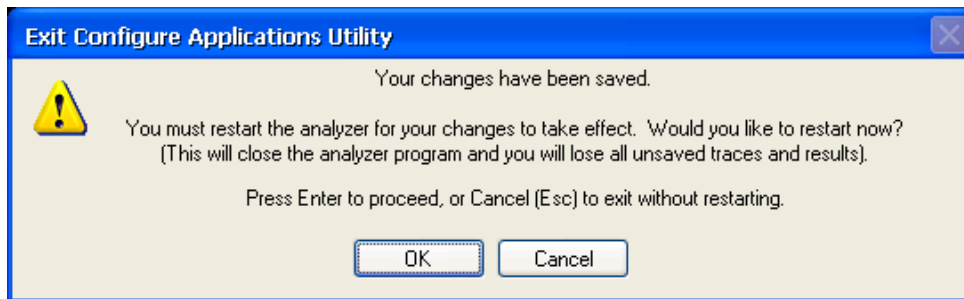

Key Path	System, Power On, Configure Applications
Remote Command	:SYSTem:PUP:PROcEss
Example	:SYST:PUP:PROC This is the SCPI command for restarting the analyzer. You must Wait after this command for the instrument application to restart
Notes	The softkey will be grayed-out when the virtual memory of the selected applications exceeds 100% of the limit.
Notes	You cannot use *WAI or *OPC? to synchronize operation after a restart. This command stops and restarts the instrument application, thus the SCPI operation is terminated and restarted. A remote program must use fixed wait time to resume sending commands to the instrument. The wait time will be dependent upon which applications are pre-loaded.
Initial S/W Revision	A.02.00
Modified at S/W Revision	A.04.00

Exit Without Saving

Pressing this key will exit the Configure Applications utility without saving your changes.

Key Path	System, Power On, Configure Applications
Initial S/W Revision	A.02.00
Modified at S/W Revision	A.04.00

Configure Applications - Instrument boot-up

At start-up of the analyzer program a dialog box similar to the one under the **System, Power On, Configure Applications** key will be displayed allowing you to choose which licensed applications are to be loaded. This dialog will only be displayed if the memory required to pre-load all of the licensed applications exceeds the Virtual Memory available.

Configure Applications - Windows desktop

The Configure Applications Utility may be run from the Windows Desktop. The utility is launched by

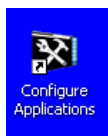

double-clicking the icon on the desktop, which brings-up a dialog box similar to the one under the **System, Power On, Configure Applications** key, allowing you to choose which licensed applications are to be loaded when the analyzer program starts up. This dialog box has mouse buttons on it which do the job that the softkeys normally do in the **System, Power On, Configure Applications** menu.

Configure Applications - Remote Commands

The following topics provide details on the using remote commands to configure the list of applications want to load into the instrument memory or query the Virtual Memory utilization for your applications.

- [“Configuration list \(Remote Command Only\)” on page 205](#)
- [“Configuration Memory Available \(Remote Command Only\)” on page 206](#)
- [“Configuration Memory Total \(Remote Command Only\)” on page 206](#)
- [“Configuration Memory Used \(Remote Command Only\)” on page 206](#)
- [“Configuration Application Memory \(Remote Command Only\)” on page 207](#)

Configuration list (Remote Command Only)

This remote command is used to set or query the list of applications to be loaded in-memory.

Remote Command	:SYSTem:PON:APPLication:LLIST <string of INSTRument:SElect names> :SYSTem:PON:APPLication:LLIST?
Example	:SYST:PON:APPL:LLIS "SA,BASIC,WCDMA"

Notes	<p><string of INSTRument:SElect names> are from the enums of the :INSTRument:SElect command.</p> <p>The order of the <INSTRument:SElect names> is the order in which the applications are loaded into memory, and the order in which they appear in the Mode Menu.</p> <p>Error -225 "Out of Memory" is reported when more applications are listed than can reside in Virtual Memory. When this occurs, the existing applications load list is unchanged.</p>
Preset	Not affected by Preset
State Saved	Not saved in instrument state
Initial S/W Revision	A.02.00

Configuration Memory Available (Remote Command Only)

This remote command is used to query the amount of Virtual Memory remaining.

Remote Command	:SYSTem:PON:APPLication:VMEMory[:AVAIlable]?
Example	:SYST:PON:APPL:VMEM?
Preset	Not affected by Preset
Initial S/W Revision	A.02.00

Configuration Memory Total (Remote Command Only)

This remote command is used to query the limit of Virtual Memory allowed for applications.

Remote Command	:SYSTem:PON:APPLication:VMEMory:TOTAL?
Example	:SYST:PON:APPL:VMEM:TOT?
Preset	Not affected by Preset
Initial S/W Revision	A.02.00

Configuration Memory Used (Remote Command Only)

This remote command is a query of the amount of Virtual Memory used by all measurement applications.

Remote Command	:SYSTem:PON:APPLication:VMEMory:USED?
Example	:SYST:PON:APPL:VMEM:USED?
Preset	Not affected by Preset
Initial S/W Revision	A.02.00

Configuration Application Memory (Remote Command Only)

This remote command is used to query the amount of Virtual Memory a particular application consumes.

Remote Command	:SYSTem:PON:APPLication:VMEMory:USED:NAME? <INSTRument:SELEct name>
Example	:SYST:PON:APPL:VMEM:USED:NAME? CDMA2K
Notes	<INSTRument:SELEct name> is from the enums of the :INSTRument:SELEct command in Meas Common section 13.3 Value returned will be 0 (zero) if the name provided is invalid.
Preset	Not affected by Preset
Initial S/W Revision	Prior to A.02.00

Restore Power On Defaults

This selection causes the Power On Type and Power On Application settings to be a reset to their default values. This level of Restore System Defaults does not affect any other system settings, mode settings and does not cause a mode switch. The Power On key, under the Restore System Defaults menu, causes the same action.

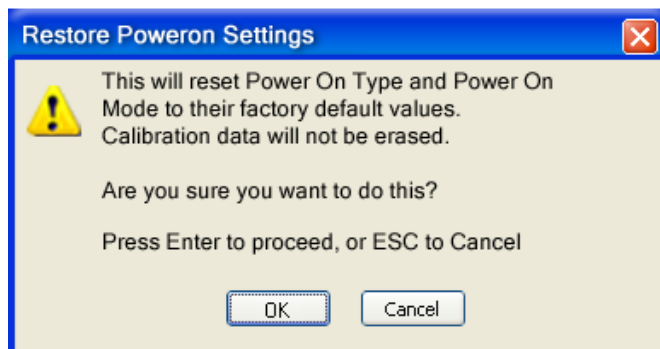

If you press any key other than OK or Enter, it is construed as a Cancel, because the only path that will actually cause the reset to be executed is through OK or Enter.

Key Path	System, Power On
Example	:SYST:DEF PON
Initial S/W Revision	Prior to A.02.00

Alignments

The Alignments Menu controls and displays the automatic alignment of the instrument, and provides the ability to restore the default alignment values.

The current setting of the alignment system is displayed in the system Settings Panel along the top of the display, including a warning icon for conditions that may cause specifications to be impacted.



Key Path	System
Initial S/W Revision	Prior to A.02.00

Auto Align

Configures the method for which the automatic background alignment is run.

Automatic background alignments are run periodically between measurement acquisitions. The instrument's software determines when alignments are to be performed to maintain warranted operation. The recommended setting for Auto Align is Normal.

An Auto Align execution cannot be aborted with the Cancel (ESC) key. To interrupt an Auto Align execution, select **Auto Align Off**.

Key Path	System, Alignments
Mode	All
Remote Command	:CALibration:AUTO ON PARTial OFF :CALibration:AUTO?
Example	:CAL:AUTO ON
Notes	While Auto Align is executing, bit 0 of Status Operation register is set.
Couplings	Auto Align is set to Off if Restore Align Data is invoked.
Preset	ON
Preset	This is unaffected by Preset but is set to ON upon a "Restore System Defaults->Align".
State Saved	No
Status Bits/OPC dependencies	When Auto Align is executing, bit 0 in the Status Operational register is set.
Initial S/W Revision	Prior to A.02.00

Normal

Auto Align, Normal turns on the automatic alignment of all measurement systems. The Auto Align, Normal selection maintains the instrument in warranted operation across varying temperature and over time.

If the condition "Align Now, All required" is set, transition to Auto Align, Normal will perform the required alignments and clear the "Align Now, All required" condition and then continue with further alignments as required to maintain the instrument adequately aligned for warranted operation.

When **Auto Align, Normal** is selected the Auto Align Off time is set to zero.

When **Auto Align, Normal** is selected the Settings Panel indicates ALIGN AUTO.

Key Path	System, Alignments, Auto Align
Mode	All
Example	:CAL:AUTO ON
Notes	<p>Alignment processing as a result of the transition to Normal will be executed sequentially. Thus, *OPC? or *WAI following CAL:AUTO ON will return when the alignment processing is complete.</p> <p>The presence of an external signal may interfere with the RF portion of the alignment. If so, the Error Condition “Align skipped: 50 MHz interference” or “Align skipped: 4.8 GHz interference” is reported, and bit 11 is set in the Status Questionable Calibration register. After the interfering signal is removed, subsequent alignment of the RF will clear the condition, and clear bit 11 in the Status Questionable Calibration register.</p>
Readback Text	Normal
Status Bits/OPC dependencies	<p>An interfering user signal may prevent automatic alignment of the RF subsystem. If this occurs, the Error Condition “Align skipped: 50 MHz interference” or “Align skipped: 4.8 GHz interference” is reported, the Status Questionable Calibration bit 11 is set, and the alignment proceeds. When a subsequent alignment of the RF subsystem succeeds, either by the next cycle of automatic alignment or from an Align Now, RF, the Error Condition and Status Questionable Calibration bit 11 are cleared.</p>
Initial S/W Revision	Prior to A.02.00

Partial

Auto Align, Partial disables the full automatic alignment and the maintenance of warranted operation for the benefit of improved measurement throughput. Accuracy is retained for the Resolution Bandwidth filters and the IF Passband which is critical to FFT accuracy, demodulation, and many measurement applications. With Auto Align set to **Partial**, you are now responsible for maintaining warranted operation by updating the alignments when they expire. The **Auto Align, Alert** mechanism will notify you when alignments have expired. One solution to expired alignments is to perform the **Align All, Now** operation. Another is to return the **Auto Align** selection to **Normal**.

Auto Align, Partial is recommended for measurements where the throughput is so important that a few percent of improvement is more valued than an increase in the accuracy errors of a few tenths of a decibel. One good application of **Auto Align, Partial** would be an automated environment where the alignments can be called during overhead time when the device-under-test is exchanged.

When **Auto Align, Partial** is selected the elapsed time counter begins for Auto Align Off time.

When **Auto Align, Partial** is selected the Settings Panel indicates ALIGN PARTIAL with a warning icon. The warning icon is to inform the operator that they are responsible for maintaining the warranted operation of the instrument

Key Path	System, Alignments, Auto Align
Mode	All

Example	:CAL:AUTO PART
Notes	Auto Align Partial begins the elapsed time counter for Auto Align Off time.
Readback Text	Partial
Initial S/W Revision	Prior to A.02.00

Off

Auto Align, Off disables automatic alignment and the maintenance of warranted operation, for the benefit of maximum measurement throughput. With Auto Align set to **Off**, you are now responsible for maintaining warranted operation by updating the alignments when they expire. The **Auto Align, Alert** mechanism will notify you when alignments have expired. One solution to expired alignments is to perform the **Align All, Now** operation. Another is to return the **Auto Align** selection to **Normal**.

The **Auto Align, Off** setting is rarely the best choice, because **Partial** gives almost the same improvement in throughput while maintaining the warranted performance for a much longer time. The **Off** choice is intended for unusual circumstances such as the measurement of radar pulses where you might like the revisit time to be as consistent as possible.

When **Auto Align, Off** is selected the Auto Align Off time is initialized and the elapsed time counter begins.

When **Auto Align, Off** is selected the Settings Panel indicates ALIGN OFF with a warning icon. The warning icon is to inform the operator that they are responsible for maintaining the warranted operation of the instrument:

Key Path	System, Alignments, Auto Align
Mode	All
Example	:CAL:AUTO OFF
Notes	Auto Align Off begins the elapsed time counter for Auto Align Off time.
Couplings	Auto Align is set to Off if Restore Align Data is invoked.
Readback Text	Off
Initial S/W Revision	Prior to A.02.00

All but RF

Auto Align, All but RF, configures automatic alignment to include or exclude the RF subsystem. (Eliminating the automatic alignment of the RF subsystem prevents the input impedance from changing. The normal input impedance of 50 ohms can change to an open circuit when alignments are being used. Some devices under test do not behave acceptably under such circumstances, for example by showing instability.) When **Auto Align, All but RF ON** is selected, the operator is responsible for performing an **Align Now, RF** when RF-related alignments expire. The **Auto Align, Alert** mechanism will notify the operator to perform an **Align Now, All** when the combination of time and temperature variation is exceeded.

When **Auto Align, All but RF ON** is selected the Settings Panel indicates ALIGN AUTO/NO RF with a warning icon (warning icon is intended to inform the operator they are responsible for the maintaining

the RF alignment of the instrument):

Key Path	System, Alignments, Auto Align
Mode	All
Remote Command	:CALibration:AUTO:MODE ALL NRF :CALibration:AUTO:MODE?
Example	:CAL:AUTO:MODE NRF
Preset	ALL
Preset	This is unaffected by Preset but is set to ALL on a “Restore System Defaults->Align”.
State Saved	No
Readback Text	RF or NRF
Initial S/W Revision	Prior to A.02.00

Alert

The instrument will signal an Alert when conditions exist such that you will need to perform a full alignment (for example, **Align Now, All**). The Alert can be configured in one of four settings; **Time & Temperature, 24 hours, 7 days**, or **None**. A confirmation is required when a selection other than **Time & Temperature** is chosen. This prevents accidental deactivation of alerts.

With **Auto Align** set to **Normal**, the configuration of **Alert** is not relevant because the instrument’s software maintains the instrument in warranted operation.

Key Path	System, Alignments, Auto Align
Mode	All
Remote Command	:CALibration:AUTO:ALERT TTEMperature DAY WEEK NONE :CALibration:AUTO:ALERT?
Example	:CAL:AUTO:ALER TTEM
Notes	The alert that alignment is needed is the setting of bit 14 in the Status Questionable Calibration register.
Preset	TTEMperature
Preset	This is unaffected by Preset but is set to TTEMperature on a “Restore System Defaults->Align”.
State Saved	No
Status Bits/OPC dependencies	The alert is the Error Condition “Align Now, All required” and bit 14 is set in the Status Questionable Calibration register.
Initial S/W Revision	Prior to A.02.00

Time & Temperature

With Auto Align Alert set to **Time & Temperature** the instrument will signal an alert when alignments expire due to the combination of the passage of time and changes in temperature. The alert is the Error Condition “Align Now, All required”. If this choice for Alert is selected, the absence of an alert means that the analyzer alignment is sufficiently up-to-date to maintain warranted accuracy.

Key Path	System, Alignments, Auto Align, Alert
Mode	All
Example	:CAL:AUTO:ALER TTEM
Readback Text	Time & Temp
Status Bits/OPC dependencies	Bit 14 is set in the Status Questionable Calibration register.
Initial S/W Revision	Prior to A.02.00

24 hours

With Auto Align Alert set to **24 Hours** the instrument will signal an alert after a time span of 24 hours since the last successful full alignment (for example, **Align Now, All** or completion of a full Auto Align). You may choose this selection in an environment where the temperature is stable on a daily basis at a small risk of accuracy errors in excess of the warranted specifications. The alert is the Error Condition “Align Now, All required”.

For front-panel operation , confirmation is required to transition into this setting of Alert. The confirmation dialog is:

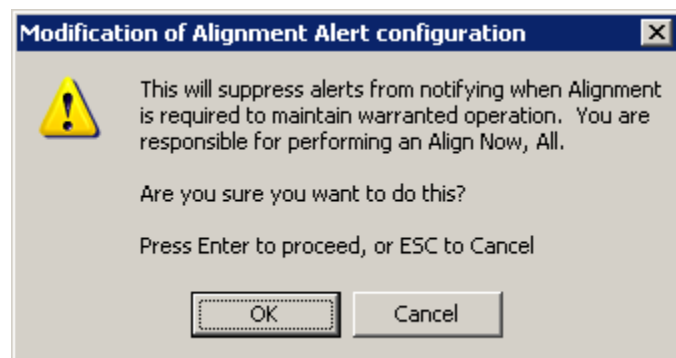

No confirmation is required when Alert is configured through a remote command.

Key Path	System, Alignments, Auto Align, Alert
Mode	All
Example	:CAL:AUTO:ALER DAY
Readback Text	24 hours
Status Bits/OPC dependencies	Bit 14 is set in the Status Questionable Calibration register.
Initial S/W Revision	Prior to A.02.00

7 days

With Auto Align Alert is set to **7 days** the instrument will signal an alert after a time span of 168 hours since the last successful full alignment (for example, **Align Now, All** or completion of a full Auto Align). You may choose this selection in an environment where the temperature is stable on a weekly basis, at a modest risk of accuracy degradations in excess of warranted performance. The alert is the Error Condition “Align Now, All required”.

For front panel operation, confirmation is required for the customer to transition into this setting of Alert. The confirmation dialog is:

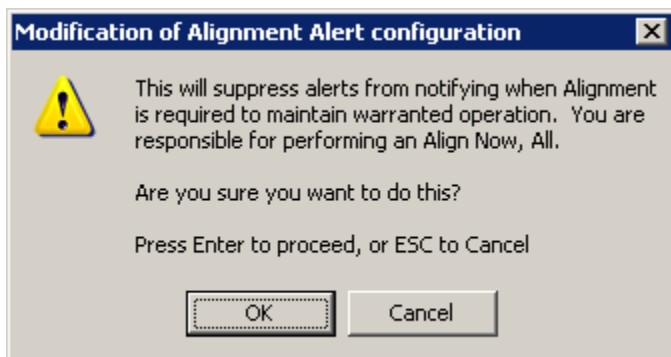

No confirmation is required when Alert is configured through a remote command.

Key Path	System, Alignments, Auto Align, Alert
Mode	All
Example	:CAL:AUTO:ALER WEEK
Readback Text	7 days
Status Bits/OPC dependencies	Bit 14 is set in the Status Questionable Calibration register.
Initial S/W Revision	Prior to A.02.00

None

With Auto Align Alert set to **None** the instrument will not signal an alert. This is provided for rare occasions where you are making a long measurement which cannot tolerate Auto Align interruptions, and must have the ability to capture a screen image at the end of the measurement without an alert posted to the display. Agilent does not recommends using this selection in any other circumstances, because of the risk of accuracy performance drifting well beyond expected levels without the operator being informed.

For front panel operation, confirmation is required to transition into this setting of Alert. The confirmation dialog is:

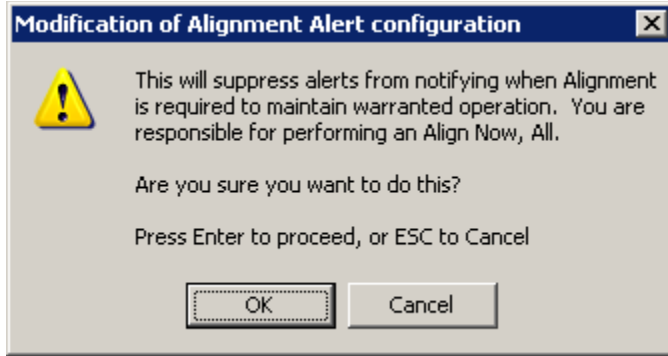

No confirmation is required when Alert is configured through a remote command.

Key Path	System, Alignments, Auto Align, Alert
Mode	All
Example	:CAL:AUTO:ALER NONE
Initial S/W Revision	Prior to A.02.00

Align Now

Accesses alignment processes that are immediate action operations. They perform complete operations and run until they are complete.

Key Path	System, Alignments
Initial S/W Revision	Prior to A.02.00

All

Immediately executes an alignment of all subsystems. The instrument stops any measurement currently underway, performs the alignment, then restarts the measurement from the beginning (similar to pressing the **Restart** key).

If an interfering user signal is present at the RF Input, the alignment is performed on all subsystems except the RF. After completion, the Error Condition “Align skipped: 50 MHz interference” or “Align skipped: 4.8 GHz interference” is set. In addition the Error Condition “Align Now, RF required” is set, and bits 11 and 12 are set in the Status Questionable Calibration register.

The query form of the remote commands (:CALibration[:ALL]? or *CAL?) invokes the alignment of all subsystems and returns a success or failure value. An interfering user signal is not grounds for failure; if the alignment was able to succeed on all portions but unable to align the RF because of an interfering signal, the resultant will be the success value.

Successful completion of **Align Now, All** will clear the “Align Now, All required” Error Condition, and clear bit 14 in the Status Questionable Calibration register. It will also begin the elapsed time counter for Last Align Now, All Time, and capture the Last Align Now, All Temperature.

If the Align RF subsystem succeeded in aligning (no interfering signal present), the elapsed time counter begins for Last Align Now, RF Time, and the temperature is captured for the Last Align Now, RF

Temperature. In addition the Error Conditions “Align skipped: 50 MHz interference” and “Align skipped: 4.8 GHz interference” are cleared, the Error Condition “Align Now, RF required” is cleared, and bits 11 and 12 are cleared in the Status Questionable Calibration register

Align Now, All can be interrupted by pressing the Cancel (ESC) front-panel key or remotely with Device Clear followed by the :ABORt SCPI command. When this occurs the Error Condition “Align Now, All required” is set, and bit 14 is set in the Status Questionable Condition register. This is because new alignment data may be employed for an individual subsystem, but not a cohesive set of data for all subsystems.

In many cases, you might find it more convenient to change alignments to **Normal**, instead of executing **Align Now, All**. When the Auto Align process transitions to **Normal**, the analyzer will immediately start to update only the alignments that have expired, thus efficiently restoring the alignment process.

Key Path	System, Alignments, Align Now
Mode	All
Remote Command	:CALibration[:ALL] :CALibration[:ALL]?
Example	:CAL
Notes	:CALibration[:ALL]? returns 0 if successful :CALibration[:ALL]? returns 1 if failed :CALibration[:ALL]? is the same as *CAL? While Align Now, All is performing the alignment, bit 0 in the Status Operation register is set. Completion, or termination, will clear bit 0 in the Status Operation register. This command is sequential; it must complete before further SCPI commands are processed. Interrupting the alignment from remote is accomplished by invoking Device Clear followed by the :ABORt command. Successful completion will clear bit 14 in the Status Questionable Calibration register. An interfering user signal is not grounds for failure of Align Now, All. However, bits 11 and 12 are set in the Status Questionable Calibration register to indicate Align Now, RF is required. An interfering user supplied signal will result in the instrument requiring an Align Now, RF with the interfering signal removed.
Couplings	Initializes the time for the Last Align Now, All Time. Records the temperature for the Last Align Now, All Temperature. If Align RF component succeeded, initializes the time for the Last Align Now, RF Time. If Align RF component succeeded, records the temperature for the Last Align Now, RF Temperature.
Status Bits/OPC dependencies	Bits 11, 12, or 14 may be set in the Status Questionable Calibration register.

System Functions
System

Initial S/W Revision	Prior to A.02.00
Mode	All
Remote Command	*CAL?
Example	*CAL?
Notes	*CAL? returns 0 if successful *CAL? returns 1 if failed :CALibration[:ALL]? is the same as *CAL? See additional remarks described with :CALibration[:ALL]? Everything about :CALibration[:ALL]? is synonymous with *CAL? including all conditions, status register bits, and couplings
Initial S/W Revision	Prior to A.02.00

All but RF

Immediately executes an alignment of all subsystems except the RF subsystem. The instrument will stop any measurement currently underway, perform the alignment, and then restart the measurement from the beginning (similar to pressing the **Restart** key). This can be used to align portions of the instrument that are not impacted by an interfering user input signal.

This operation might be chosen instead of **All** if you do not want the device under test to experience a large change in input impedance, such as a temporary open circuit at the analyzer input.

The query form of the remote commands (:CALibration:NRF?) will invoke the alignment and return a success or failure value.

Successful completion of **Align Now, All but RF** will clear the “Align Now, All required” Error Condition, and clear bit 14 in the Status Questionable Calibration register. If “Align Now, All required” was in effect prior to executing the All but RF, the Error Condition “Align Now, RF required” is asserted and bit 12 in the Status Questionable Calibration register is set. It will also begin the elapsed time counter for Last Align Now, All Time, and capture the Last Align Now, All Temperature.

Align Now, All but RF can be interrupted by pressing the Cancel (ESC) front-panel key or remotely with Device Clear followed by the :ABORt SCPI command. When this occurs the Error Condition “Align Now, All required” is set, and bit 14 is set in the Status Questionable Condition register. This is because new alignment data may be used for an individual subsystem, but not a full new set of data for all subsystems.

Key Path	System, Alignments, Align Now
Mode	All
Remote Command	:CALibration:NRF :CALibration:NRF?
Example	:CAL:NRF

Notes	<p>:CALibration:NRF? returns 0 if successful</p> <p>:CALibration:NRF? returns 1 if failed</p> <p>While Align Now, All but RF is performing the alignment, bit 0 in the Status Operation register is set. Completion, or termination, will clear bit 0 in the Status Operation register.</p> <p>This command is sequential; it must complete before further SCPI commands are processed. Interrupting the alignment from remote is accomplished by invoking Device Clear followed by the :ABORt command.</p> <p>Successful completion will clear bit 14 in the Status Questionable Calibration register and set bit 12 if invoked with “Align Now, All required”.</p>
Couplings	<p>Initializes the time for the Last Align Now, All Time.</p> <p>Records the temperature for the Last Align Now, All Temperature.</p>
Status Bits/OPC dependencies	Bits 12 or 14 may be set in the Status Questionable Calibration register.
Initial S/W Revision	Prior to A.02.00

RF

Immediately executes an alignment of the RF subsystem. The instrument stops any measurement currently underway, performs the alignment, then restarts the measurement from the beginning (similar to pressing the **Restart** key).

This operation might be desirable if the alignments had been set to not include RF alignments, or if previous RF alignments could not complete because of interference which has since been removed.

If an interfering user signal is present at the RF Input, the alignment will terminate and raise the Error Condition “Align skipped: 50 MHz interference” or “Align skipped: 4.8 GHz interference”, and Error Condition “Align Now, RF required”. In addition, bits 11 and 12 will be set in the Status Questionable Calibration register.

The query form of the remote commands (:CALibration:RF?) will invoke the alignment of the RF subsystem and return a success or failure value. An interfering user signal is grounds for failure.

A failure encountered during alignment will set the Error Condition “Align RF failed” and set bit 3 in the Status Questionable Calibration register.

Successful completion of **Align Now, RF** clears the Error Conditions “Align skipped: 50 MHz interference” and “Align skipped: 4800 MHz interference” and the Error Conditions “Align RF failed” and “Align Now, RF required”, and clears bits 3, 11, and 12 in the Status Questionable Calibration register. It will also begin the elapsed time counter for Last Align Now, RF Time, and capture the Last Align Now, RF Temperature.

Align Now, RF can be interrupted by pressing the Cancel (ESC) front-panel key or remotely with Device Clear followed by the :ABORt SCPI command. When this occurs, the Error Condition “Align Now, RF required” is set, and bit 12 is set in the Status Questionable Condition register. None of the new alignment data is used.

Key Path	System, Alignments, Align Now
Mode	All

Remote Command	:CALibration:RF :CALibration:RF?
Example	:CAL:RF
Notes	<p>:CALibration:RF? returns 0 if successful</p> <p>:CALibration:RF? returns 1 if failed (including interfering user signal)</p> <p>While Align Now, RF is performing the alignment, bit 0 in the Status Operation register is set. Completion, or termination, will clear bit 0 in the Status Operation register.</p> <p>This command is sequential; it must complete before further SCPI commands are processed. Interrupting the alignment from remote is accomplished by invoking Device Clear followed by the :ABORt command.</p> <p>Successful completion will clear bits 3, 11, and 12 in the Status Questionable Calibration register.</p> <p>A failure encountered during alignment will set the Error Condition “Align RF failed” and set bit 3 in the Status Questionable Calibration register.</p> <p>An interfering user signal will result in bits 11 and 12 to be set in the Status Questionable Calibration register to indicate Align Now, RF is required.</p> <p>An interfering user supplied signal will result in the instrument requiring an Align Now, RF with the interfering signal removed.</p>
Couplings	<p>Initializes the time for the Last Align Now, RF Time.</p> <p>Records the temperature for the Last Align Now, RF Temperature.</p>
Status Bits/OPC dependencies	Bits 11, 12, or 14 may be set in the Status Questionable Calibration register.
Initial S/W Revision	Prior to A.02.00

Show Alignment Statistics

Shows alignment information you can use to ensure that the instrument is operating in a specific manner. The Show Alignment Statistics screen is where you can view time and temperature information.

Values which are displayed are only updated when the Show Alignment Statistics screen is invoked, they are not updated while the Show Alignment Statistics screen is being displayed. The remote commands which access this information obtain current values.

An example of the Show Alignment Statistics screen would be similar to:

Std Header	Product Number: N9020A Serial Number: US46340924 Firmware Revision: A.01.01	
Instrument Info	Time since start-up: 300 hrs Current Temperature: +28 degC	} Times & Temperature delta. Shown as "---" if none since start-up.
Auto Align Info	Time while Auto Align off: 90 min	
Std Align Now	Time since last Align Now All: 12.5 hrs Temperature since last Align Now All: -1.3 degC Time since last Align Now RF: 5 min Temperature since last Align Now RF: +0.1 degC	} Time & Temperature 'stamp'
If TG Option (Not Zorro1)	Time since last Align TG: 2.5 hrs Temperature since last Align TG: +0.2 degC	
Opts 508,513 526	Last Characterize Preselector: Jun 1, 2006 15:00:00 Last Characterize Preselector Temperature: +32.1 degC	

A successful Align Now, RF will set the Last Align RF temperature to the current temperature, and reset the Last Align RF time. A successful Align Now, All or Align Now, All but RF will set the Last Align Now All temperature to the current temperature, and reset the Last Align Now All time. A successful Align Now, All will also reset the Last Align RF items if the RF portion of the Align Now succeeded.

Key Path	System, Alignments
Mode	All
Notes	The values displayed on the screen are only updated upon entry to the screen and not updated while the screen is being displayed.
Initial S/W Revision	Prior to A.02.00

Key Path	Visual annotation in the Show Alignment Statistics screen
Mode	All
Remote Command	:SYSTem: PON: TIME?
Example	:SYST:PON:TIME?
Notes	Value is the time since the most recent start-up in seconds.
State Saved	No
Initial S/W Revision	Prior to A.02.00

Key Path	Visual annotation in the Show Alignment Statistics screen
Mode	All
Remote Command	:CALibration: TEMPerature: CURRent?

System Functions
System

Example	:CAL:TEMP:CURR?
Notes	Value is in degrees Centigrade. Value is invalid if using default alignment data (Align Now, All required)
State Saved	No
Initial S/W Revision	Prior to A.02.00

Key Path	Visual annotation in the Show Alignment Statistics screen
Mode	All
Remote Command	:CALibration:TIME:LALL?
Example	:CAL:TIME:LALL?
Notes	Value is the elapsed time, in seconds, since the last successful Align Now, All or Align Now, All but RF was executed.
State Saved	No
Initial S/W Revision	Prior to A.02.00

Key Path	Visual annotation in the Show Alignment Statistics screen
Mode	All
Remote Command	:CALibration:TEMPerature:LALL?
Example	:CAL:TEMP:LALL?
Notes	Value is in degrees Centigrade at which the last successful Align Now, All or Align Now, All but RF was executed.
State Saved	No
Initial S/W Revision	Prior to A.02.00

Key Path	Visual annotation in the Show Alignment Statistics screen
Mode	All
Remote Command	:CALibration:TIME:LRF?
Example	:CAL:TIME:LRF?
Notes	Value is the elapsed time, in seconds, since the last successful Align Now, RF was executed, either individually or as a component of Align Now, All.
State Saved	No
Initial S/W Revision	Prior to A.02.00

Key Path	Visual annotation in the Show Alignment Statistics screen
----------	--

Mode	All
Remote Command	:CALibration:TEMPerature:LRF?
Example	:CAL:TEMP:LRF?
Notes	Value is in degrees Centigrade at which the last successful Align Now, RF was executed, either individually or as a component of Align Now, All.
State Saved	No
Initial S/W Revision	Prior to A.02.00

Key Path	Visual annotation in the Show Alignment Statistics screen
Mode	All
Remote Command	:CALibration:TIME:LPreselector?
Example	:CAL:TIME:LPR?
Notes	Value is date and time the last successful Characterize Preselector was executed. The date is separated from the time by a space character. Returns "" if no Characterize Preselector has ever been performed on the instrument.
Dependencies	In models that do not include preselectors, this command is not enabled and any attempt to set or query will yield an error.
State Saved	No
Initial S/W Revision	Prior to A.02.00

Key Path	Visual annotation in the Show Alignment Statistics screen
Mode	All
Remote Command	:CALibration:TEMPerature:LPreselector?
Example	:CAL:TEMP:LPR?
Notes	Value is in degrees Centigrade at which the last successful Characterize Preselector was executed.
Dependencies	In models that do not include preselectors, this command is not enabled and any attempt to set or query will yield an error.
State Saved	No
Initial S/W Revision	Prior to A.02.00

Key Path	Visual annotation in the Show Alignment Statistics screen
Mode	All
Remote Command	:CALibration:AUTO:TIME:OFF?
Example	:CAL:AUTO:TIME:OFF?

Notes	Value is the elapsed time, in seconds, since Auto Align has been set to Off or Off with Alert. The value is 0 if Auto Align is ALL or NORF.
State Saved	No
Initial S/W Revision	Prior to A.02.00

Restore Align Defaults

Initializes the alignment user interface settings, not alignment data, to the factory default values. Align Now, All must be executed if the value of the Timebase DAC results in a change.

For front panel operation, you are prompted to confirm action before setting the alignment parameters to factory defaults:

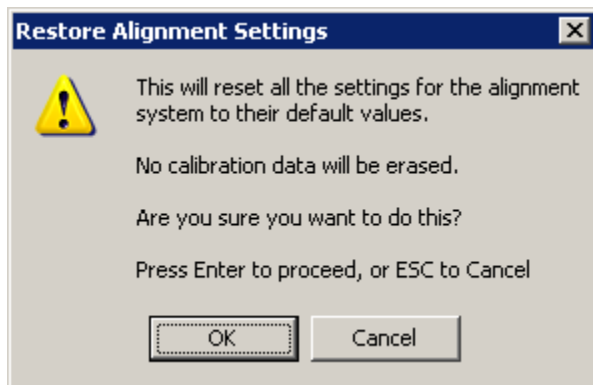

The parameters affected are:

Parameter	Setting
Timebase DAC	Calibrated
Timebase DAC setting	Calibrated value
Auto Align State	Normal (if the instrument is not operating with default alignment data, Off otherwise)
Auto Align All but RF	Off
Auto Align Alert	Time & Temperature

Key Path	System, Alignments
Mode	All
Example	:SYST:DEF ALIG
Notes	Alignment processing that results as the transition to Auto Alignment Normal will be executed sequentially; thus *OPC? or *WAI will wait until the alignment processing is complete.
Initial S/W Revision	Prior to A.02.00

Backup and Restore Alignment Data

Alignment data for the instrument resides on the hard drive in a database. Agilent uses high quality hard drives; however it is highly recommended the alignment data be backed-up to storage outside of the instrument. Additionally, for customers who use multiple CPU Assemblies or multiple disk drives, the alignment that pertains to the instrument must be transferred to the resident hard drive after a CPU or hard drive is replaced. This utility facilitates backing-up and restoring the alignment data.

NOTE This utility allows the operator to navigate to any location of the Windows file system. It is intended that the operator use a USB memory device or Mapped Network Drive to backup the alignment data to storage outside of the instrument.

Backup or Restore Align Data...

Opens the utility for backing-up or restoring the alignment data.

Key Path	System, Alignments
Initial S/W Revision	A.02.00

Key Path	System, Alignments
Mode	All
Remote Command	:CALibration:DATA:DEFault
Example	:CAL:DATA:DEF
Couplings	Sets Auto Align to Off. Sets bit 14 in the Status Questionable Calibration register. The Error Condition "Align Now, All required" is set.
Initial S/W Revision	Prior to A.02.00

Alignment Data Wizard

The Backup or Restore Alignment Data wizard will guide you through the operation of backing-up or restoring the alignment data.

The following dialogue boxes operate without a mouse or external keyboard when you use the default file names.

System Functions
System

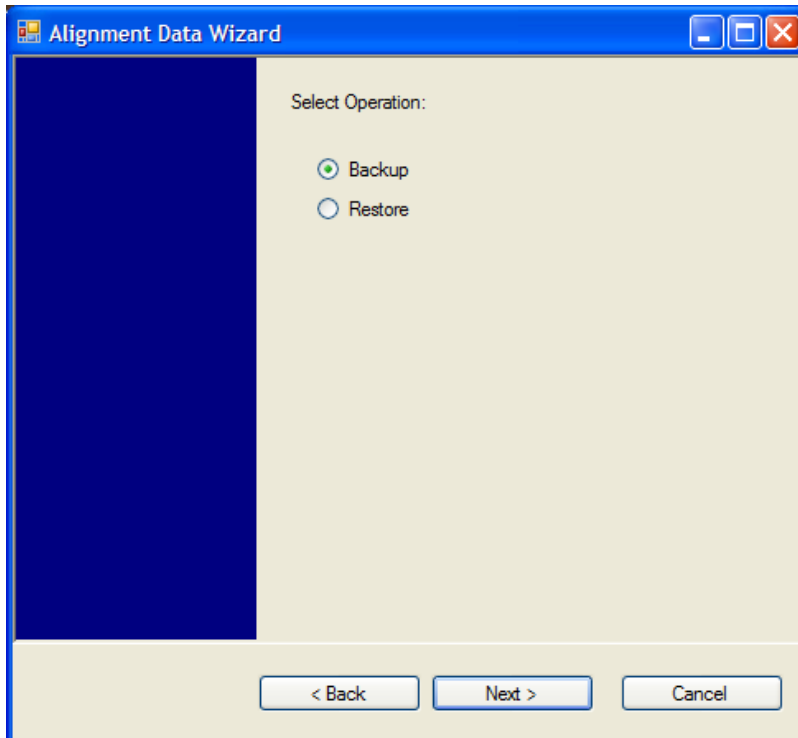
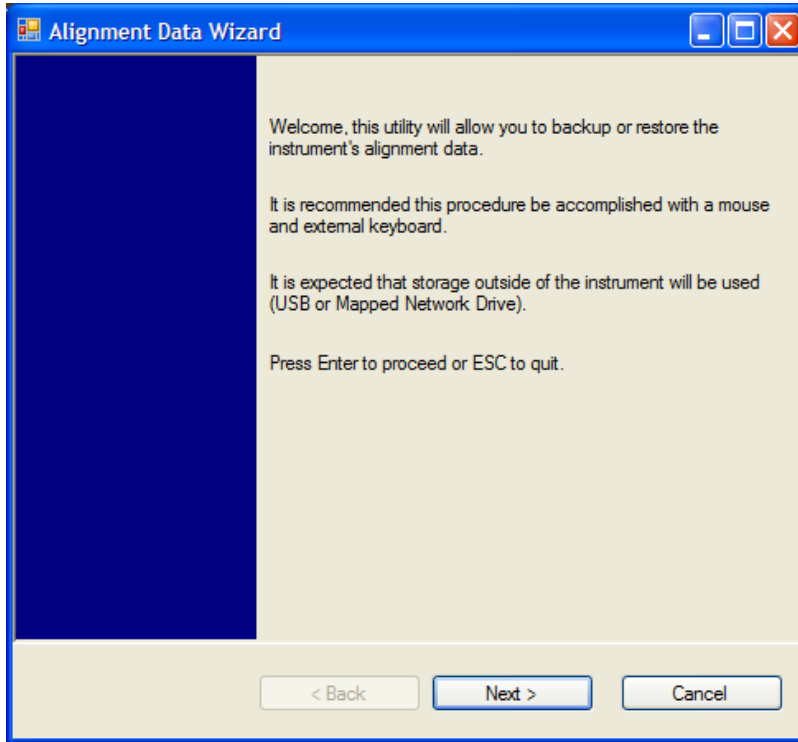

The backup screen will indicate the approximate amount of space required to contain the backup file.

The default file name will be AlignDataBackup_<model number>_<serial number>_<date in YYYYMMDDHHMMSS>.bak.

For the N9030A the default backup location will be the internal F: drive which is a solid-state memory device

located internally on the instrument.

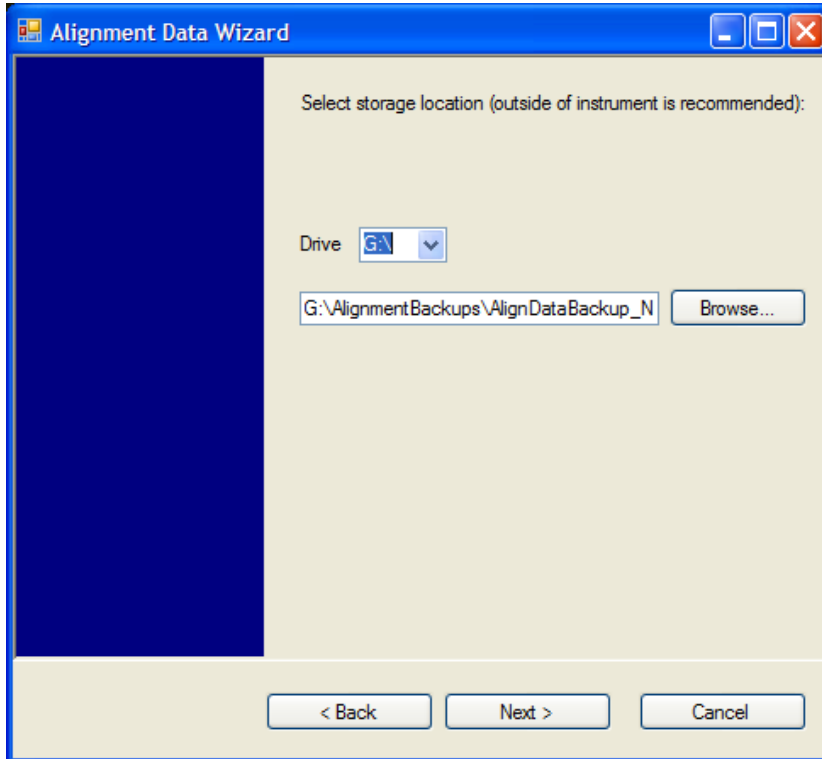

Changing the drive letter will also modify the path displayed in the box below. When this step is first loaded, the drive drop-down is populated with connected drives which provide the user with write access. If there are many unreachable network drives connected to the instrument, this step can take a few seconds. If a USB drive is present, it will be selected by default. The path defaults to the AlignmentBackups folder, and a filename will be automatically created in the form of AlignDataBackup_<model>_<serial number>_<date><time>. When the "Next >" button is pressed, the user will be prompted to create a new folder if the chosen path does not yet exist.

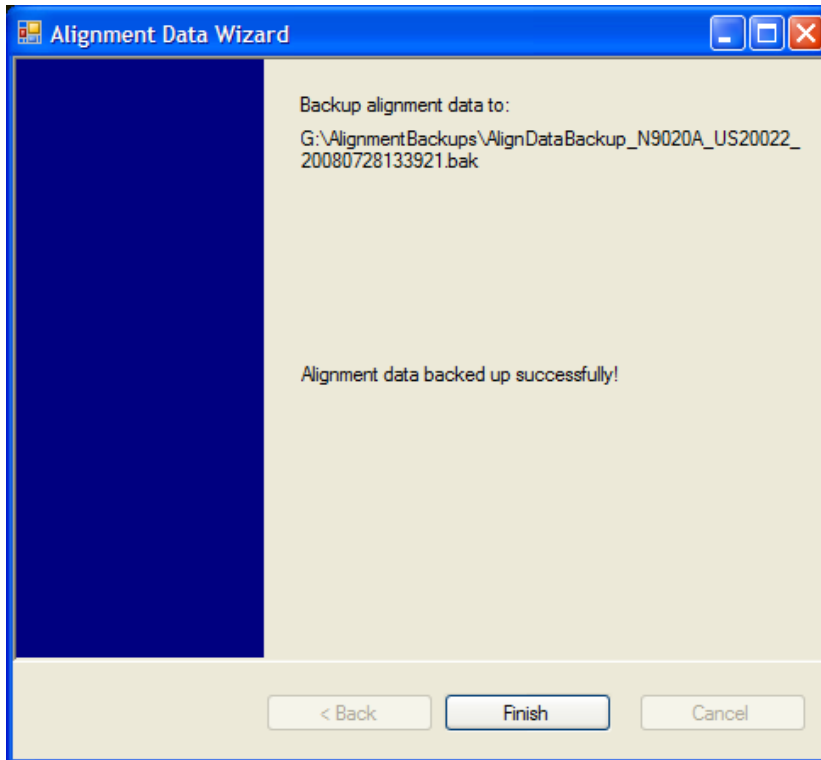
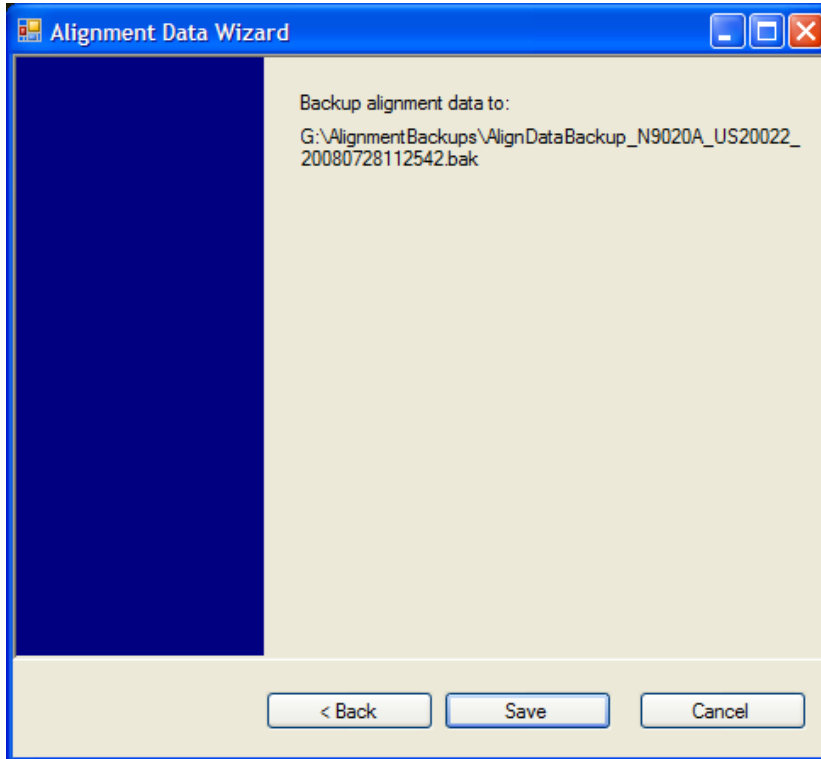

The restore operation will check the validity of the restore file using the database's built-in file validation. If the restore file is corrupt, the existing alignment data will remain in use.

For the N9030A, the default restore location will be the internal F: drive which is a solid-state memory device

located internally on the instrument. The default restore file will be the most recent file that matches the default backup file name format: AlignDataBackup_N9030A_<serial number>_<date>.bak

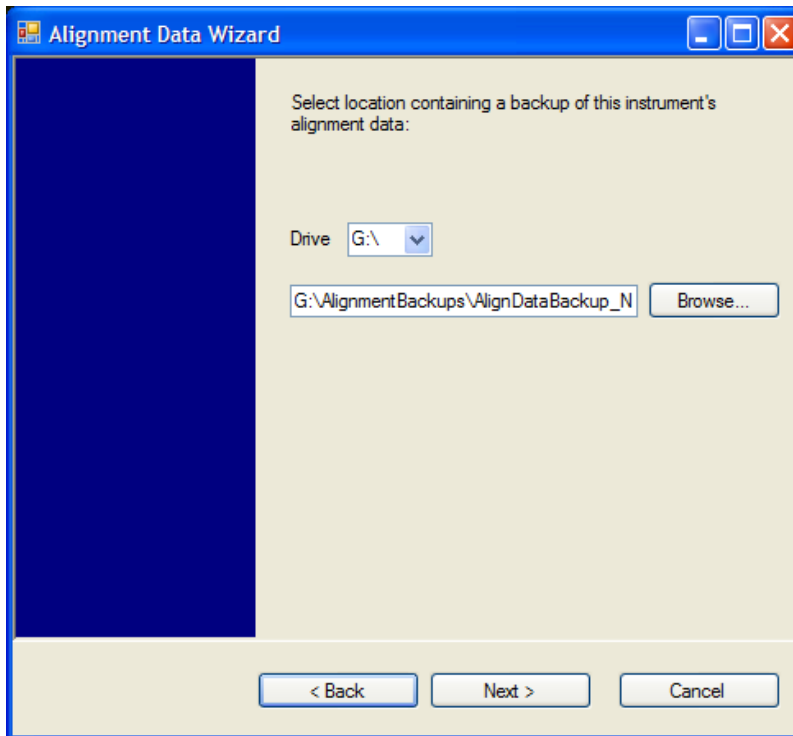

Changing the drive letter will also modify the path displayed in the box below. When this step is first loaded, the drive drop-down is populated with connected drives which provide the user with read access. The path defaults to the AlignBackups folder. The most recent *.bak file in the folder will also be selected by default.

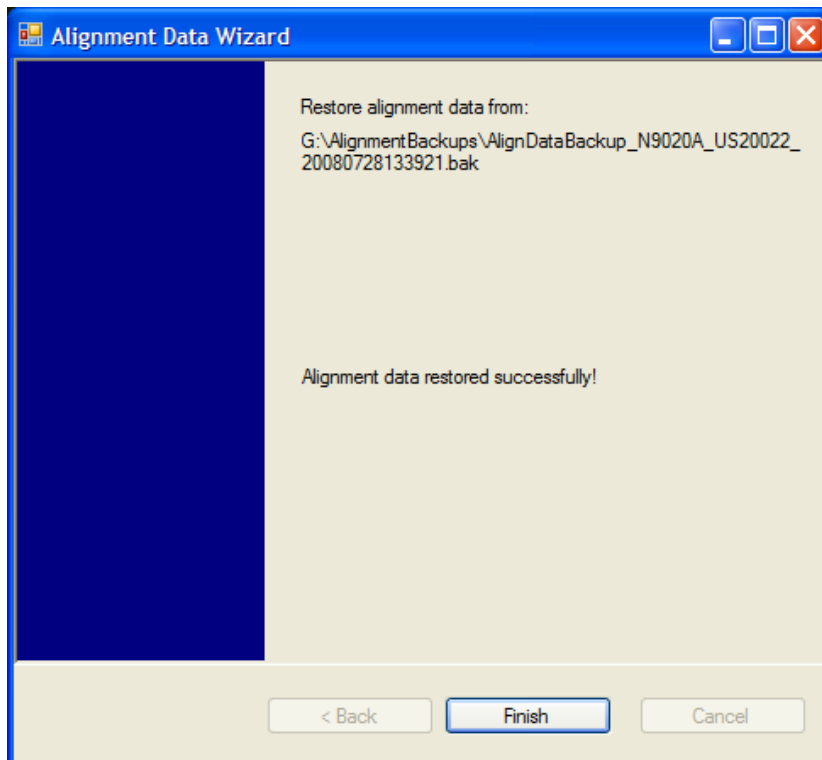
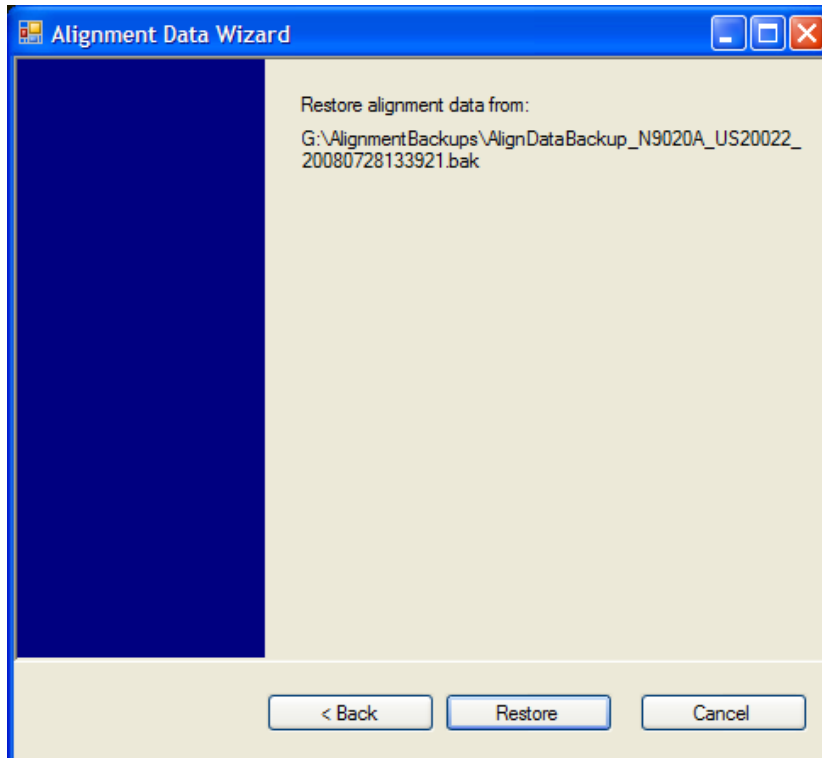

Perform Backup (Remote Command Only)

Invokes an alignment data backup operation to the provided Folder.

NOTE It is recommended that the Folder provided is outside of the instrument (USB or Mapped Network Drive).

Remote Command	:CALibration:DATA:BACKup <filename>
Example	:CAL:DATA:BACK "F:\AlignDataBackup_N9020A_US00000001_2008140100.bak"
Initial S/W Revision	A.02.00

Perform Restore (Remote Command Only)

Invokes an alignment data restore operation from the provided filename.

Remote Command	:CALibration:DATA:RESTore <filename>
Example	:CAL:DATA:REST "F:\ AlignDataBackup_N9020A_US00000001_2008140100.bak "
Initial S/W Revision	A.02.00

Advanced

Accesses alignment processes that are immediate action operations that perform operations that run until complete. Advanced alignments are performed on an irregular basis, or require additional operator interaction

Key Path	System, Alignments
Initial S/W Revision	Prior to A.02.00

Characterize Preselector (Only with Option 507, 508, 513, or 526)

The Preselector tuning curve drifts over temperature and time. Recognize that the **Amplitude, Presel Center** function adjusts the preselector for accurate amplitude measurements at an individual frequency. **Characterize Preselector** improves the amplitude accuracy by ensuring the Preselector is approximately centered at all frequencies without the use of the **Amplitude, Presel Center** function. **Characterize Preselector** can be useful in situations where absolute amplitude accuracy is not of utmost importance, and the throughput savings or convenience of not performing a **Presel Center** is desired. **Presel Center** is required prior to any measurement for best (and warranted) amplitude accuracy.

Agilent recommends that the **Characterize Preselector** operation be performed yearly as part of any calibration, but performing this operation every three months can be worthwhile.

Characterize Preselector immediately executes a characterization of the Preselector, which is a YIG-tuned filter (YTF). The instrument stops any measurement currently underway, performs the characterization, then restarts the measurement from the beginning (similar to pressing the **Restart** key).

The query form of the remote commands (:CALibration:YTF?) will invoke the alignment of the YTF

System Functions

System

subsystem and return a success or failure value.

A failure encountered during alignment will set the Error Condition “Characterize YTF failed” and set bit 9 in the Status Questionable Calibration register.

Successful completion of **Advanced, Characterize Preselector** will clear the Error Condition “Characterize YTF failed”, and clear bit 9 in the Status Questionable Calibration register. It will also begin the elapsed time counter for Last Characterize Preselector Time, and capture the Last Characterize Preselector Temperature.

The last Characterize Preselector Time and Temperature must survive across the power cycle as this operation is performed infrequently.

Advanced, Characterize Preselector can be interrupted by pressing the Cancel (ESC) front-panel key or remotely with Device Clear followed by the :ABORt SCPI command. None of the new characterization data is then used.

Key Path	System, Alignments, Advanced
Mode	All
Remote Command	:CALibration:YTF :CALibration:YTF?
Example	:CAL:YTF
Notes	:CALibration:YTF? returns 0 if successful :CALibration:YTF? returns 1 if failed (including interfering user signal) While Advanced, Characterize Preselector is performing the alignment, bit 0 in the Status Operation register is set. Completion, or termination, will clear bit 0 in the Status Operation register. This command is sequential; it must complete before further SCPI commands are processed. Interrupting the alignment from remote is accomplished by invoking Device Clear followed by the :ABORt command. Successful completion will clear bit 9 in the Status Questionable Calibration register. A failure encountered during alignment will set the Error Condition “Characterize Preselector failed” and set bit 9 in the Status Questionable Calibration register. For Option 507, 508, 513, and 526 only.
Dependencies	This key does not appear in models that do not contain preselectors. In these models the SCPI command is accepted without error but no action is taken.
Couplings	Initializes the time for the Last Characterize Preselector Time. Records the temperature for the Last Characterize Preselector Temperature.
Initial S/W Revision	Prior to A.02.00

Timebase DAC

Allows control of the internal 10 MHz reference oscillator timebase. This may be used to adjust for

minor frequency alignment between the signal and the internal frequency reference. This adjustment has no effect if the instrument is operating with an External Frequency Reference.

If the value of the Timebase DAC changes (by switching to Calibrated from User with User set to a different value, or in User with a new value entered) an alignment may be necessary. The alignment system will take appropriate action; which will either invoke an alignment or cause an Alert.

Key Path	System, Alignments
Mode	All
Remote Command	:CALibration:FREQuency:REFeRence:MODE CALibrated USER :CALibration:FREQuency:REFeRence:MODE?
Example	:CAL:FREQ:REF:MODE CAL
Notes	If the value of the timebase is changed the alignment system automatically performs an alignment or alerts that an alignment is due. If the value of the timebase is changed the alignment system automatically performs an alignment or alerts that an alignment is due.
Preset	CAL
Preset	This is unaffected by Preset but is set to CALibrated on a “Restore System Defaults->Align”.
State Saved	No
Initial S/W Revision	Prior to A.02.00

Calibrated

Sets the Timebase DAC to the value established during factory or field calibration. The value displayed on the menu key is the calibrated value.

Key Path	System, Alignments, Timebase DAC
Mode	All
Example	:CAL:FREQ:REF:MODE CAL
Readback Text	[xxx] < where xxx is the calibrated value
Initial S/W Revision	Prior to A.02.00

User

Allows setting the Timebase DAC to a value other than the value established during the factory or field calibration. The value displayed on the menu key is the calibrated value.

Key Path	System, Alignments, Timebase DAC
Mode	All
Example	:CAL:FREQ:REF:MODE USER

System Functions
System

Readback Text	xxx < where xxx is the Timebase DAC setting
Initial S/W Revision	Prior to A.02.00

Key Path	System, Alignments, Timebase DAC
Mode	All
Remote Command	:CALibration:FREQuency:REFerence:FINE <integer> :CALibration:FREQuency:REFerence:FINE?
Example	:CAL:FREQ:REF:FINE 8191
Notes	If the value of the timebase is changed the alignment system automatically performs an alignment or alerts that an alignment is due.
Couplings	Setting :CAL:FREQ:REF:FINE sets :CAL:FREQ:REF:MODE USER
Preset	This is unaffected by Preset but is set to the factory setting on a “Restore System Defaults->Align”.
State Saved	No
Min	0
Max	16383
Initial S/W Revision	Prior to A.02.00

Remote Command	:CALibration:FREQuency:REFerence:COARse <integer> :CALibration:FREQuency:REFerence:COARse?
Example	:CAL:FREQ:REF:COAR 8191
Notes	This is an alias for CAL:FREQ:REF:FINE any change to COARse is reflected in FINE and vice-versa. See CAL:FREQ:REF:FINE for description of functionality.
Couplings	Setting :CAL:FREQ:REF:COAR sets :CAL:FREQ:REF:MODE USER
Initial S/W Revision	Prior to A.02.00

I/O Config

Activates a menu for identifying and changing the I/O configuration for remote control.

Key Path	System
Initial S/W Revision	Prior to A.02.00

GPIB

Activates a menu for configuring the GPIB I/O port.

Key Path	System, I/O Config
Initial S/W Revision	A.02.00

GPIB Address

Select the GPIB remote address.

Key Path	System, I/O Config, GPIB
Mode	All
Remote Command	:SYSTem:COMMunicate:GPIB [1] [:SELF] :ADDRESS <integer> :SYSTem:COMMunicate:GPIB [1] [:SELF] :ADDRESS?
Example	:SYST:COMM:GPIB:ADDR 17
Notes	Changing the Address on the GPIB port requires all further communication to use the new address.
Preset	18
Preset	This is unaffected by Preset but is set to 18 on a “Restore System Defaults->Misc”
State Saved	No
Range	0 to 30
Initial S/W Revision	Prior to A.02.00

GPIB Controller

Sets the GPIB port into controller or device mode. In the normal state, GPIB controller is disabled, which allows the analyzer to be controlled by a remote computer. When GPIB Controller is enabled, the instrument can run software applications that use the instrument's computer as a GPIB controller; controlling devices connected to the instrument's GPIB port.

NOTE When GPIB Controller is enabled, the analyzer application itself cannot be controlled over GPIB. In this case it can easily be controlled via LAN or USB. The GPIB port cannot be a controller and device at the same time. Only one controller can be active on the GPIB bus at any given time. If the analyzer is the controller, an external PC cannot be a controller.

To control the instrument from the software that is performing GPIB controller operation, you can use an internal TCP/IP connection to the analyzer application. Use the address TCPIP0:localhost:inst0:INSTR to send SCPI commands to the analyzer application.

Key Path	System, I/O Config, GPIB
----------	---------------------------------

System Functions
System

Mode	All
Scope	Mode Global
Remote Command	:SYSTem:COMMunicate:GPIB[1] [:SELF] :CONTroller[:ENABle] ON OFF 0 1 :SYSTem:COMMunicate:GPIB[1] [:SELF] :CONTroller[:ENABle]?
Example	:SYST:COMM:GPIB:CONT ON Will set GPIB port to Controller
Notes	When the instrument becomes the Controller bit 0 in the Standard Event Status Register is set (and when the instrument relinquishes Controller capability bit 0 is cleared in the Standard Event Status Register).
Preset	OFF
Preset	This is unaffected by Preset but is set to OFF on a “Restore System Defaults->Misc”
State Saved	No
Range	Disabled Enabled
Initial S/W Revision	A.02.00

Disabled

Disables the GPIB Controller capability, this is the default (or normal) setting.

Key Path	System, I/O Config, GPIB, GPIB Controller
Example	:SYST:COMM:GPIB:CONT OFF Will set GPIB port to Device
Initial S/W Revision	A.02.00

Enabled

Enables the GPIB Controller capability.

Key Path	System, I/O Config, GPIB, GPIB Controller
Example	:SYST:COMM:GPIB:CONT ON Will set GPIB port to Controller
Initial S/W Revision	A.02.00

SCPI LAN

Activates a menu for identifying and changing the SCPI over a LAN configuration. There are a number of different ways to send SCPI remote commands to the instrument over LAN. It can be a problem to have multiple users simultaneously accessing the instrument over the LAN. These keys limit that somewhat by disabling the telnet, socket, and/or SICL capability.

Key Path	System, I/O Config
Initial S/W Revision	Prior to A.02.00

SCPI Telnet

Turns the SCPI LAN telnet capability On or Off allowing you to limit SCPI access over LAN through telnet.

Key Path	System, I/O Config, SCPI LAN
Mode	All
Remote Command	:SYSTem:COMMunicate:LAN:SCPI:TELNet:ENABle OFF ON 0 1 :SYSTem:COMMunicate:LAN:SCPI:TELNet:ENABle?
Example	:SYST:COMM:LAN:SCPI:TELN:ENAB OFF
Preset	ON
Preset	This is unaffected by Preset but is set to ON with a “Restore System Defaults->Misc”
State Saved	No
Range	On Off
Initial S/W Revision	Prior to A.02.00

SCPI Socket

Turns the capability of establishing Socket LAN sessions On or Off. This allows you to limit SCPI access over LAN through socket sessions.

Key Path	System, I/O Config, SCPI LAN
Mode	All
Remote Command	:SYSTem:COMMunicate:LAN:SCPI:SOCKet:ENABle OFF ON 0 1 :SYSTem:COMMunicate:LAN:SCPI:SOCKet:ENABle?
Example	:SYST:COMM:LAN:SCPI:SOCK:ENAB OFF
Preset	ON
Preset	This is unaffected by a Preset but is set to ON with a “Restore System Defaults->Misc”
State Saved	No
Range	On Off
Initial S/W Revision	Prior to A.02.00

SCPI Socket Control Port (Remote Command Only)

Returns the TCP/IP port number of the control socket associated with the SCPI socket session. This query enables you to obtain the unique port number to open when a device clear is to be sent to the instrument. Every time a connection is made to the SCPI socket, the instrument creates a peer control socket. The port number for this socket is random. The user must use this command to obtain the port number of the control socket. To force a device clear on this socket, open the port and send the string

System Functions
System

“DCL ” to the instrument.

If this SCPI command is sent to a non SCPI Socket interface, then 0 is returned.

Mode	All
Remote Command	:SYSTem:COMMunicate:LAN:SCPI:SOCKet:CONTRol?
Example	:SYST:COMM:LAN:SCPI:SOCK:CONT?
Preset	This is unaffected by Preset or “Restore System Defaults->Misc”.
State Saved	No
Range	0 to 65534
Initial S/W Revision	Prior to A.02.00

SICL Server

Turns the SICL server capability On or Off, enabling you to limit SCPI access over LAN through the SICL server. (SICL IEEE 488.2 protocol.)

Parameter	Description	Setting
Maximum Connections	The maximum number of connections that can be accessed simultaneously	5
Instrument Name	The name (same as the remote SICL address) of your analyzer	inst0
Instrument Logical Unit	The unique integer assigned to your analyzer when using SICL LAN	8
Emulated GPIB Name	The name (same as the remote SICL address) of the device used when communicating with your analyzer	gpib7
Emulated GPIB Logical Unit	The unique integer assigned to your device when it is being controlled using SICL LAN	8
Emulated GPIB Address	The emulated GPIB address assigned to your transmitter tester when it is a SICL server (the same as your GPIB address)	18

Key Path	System, I/O Config, SCPI LAN
Mode	All
Remote Command	:SYSTem:COMMunicate:LAN:SCPI:SICL:ENABle OFF ON 0 1 :SYSTem:COMMunicate:LAN:SCPI:SICL:ENABle?
Example	:SYST:COMM:LAN:SCPI:SICL:ENAB OFF
Preset	ON

Preset	This is unaffected by Preset, but is set to ON with a “Restore System Defaults->Misc”
State Saved	No
Range	On Off
Initial S/W Revision	Prior to A.02.00

Reset Web Password

The embedded web server contains certain capability which are password protected; modifying the LAN configuration of the instrument, and access to web pages that can change the settings of the instrument. The default password from the factory is ‘agilent’ (without the quotes). The control provided here is the means to set the web password as the user desires, or to reset the password to the factory default.

Selecting Reset web password brings up a control for resetting the password as the user desires, or to the factory default. A keyboard is required to change the password from the factory default of ‘agilent’ or to set a new password that contains alphabetic characters. The control is:

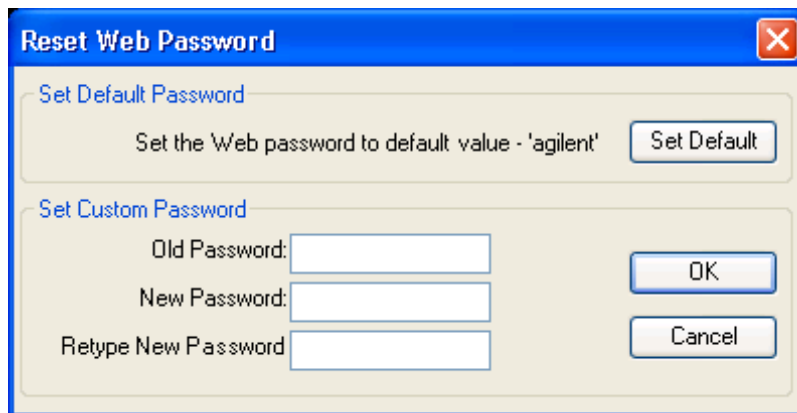

If this control is entered without an external keyboard or mouse connected, you can cancel the control by pressing the Cancel (ESC) front-panel key.

Key Path	System, I/O Config
Mode	All
Initial S/W Revision	Prior to A.02.00

LXI

Opens a menu that allows you to access the various LXI configuration properties.

Key Path	System, I/O Config
Initial S/W Revision	Prior to A.02.00

LAN Reset

Resets the LAN connection.

Key Path	System, I/O Config, LXI
Initial S/W Revision	Prior to A.02.00

LXI Domain

The instrument only receives LXI LAN Events sent by members of the same LXI Domain. Conversely, LXI Output LAN Events sent by the instrument can only be received by members of the same LXI Domain. This is not the same as the IEEE 1588 domain (see [“Domain \(Remote Command Only\)” on page 256](#)“Domain (Remote Command Only)” on page 256).

Key Path	System, I/O Config, LXI
Remote Command	:LXI:EVENT:DOMain <intDomain> :LXI:EVENT:DOMain?
Example	:LXI:EVEN:DOM 128 :LXI:EVEN:DOM?
Preset	0
Preset	Not affected by a Preset. The default value of "0" can be restored by pressing Restore Defs, Input/Output Settings
State Saved	Saved in instrument state.
Range	0–255
Initial S/W Revision	Prior to A.02.00

LXI Output LAN Events

The device can be configured to send LXI LAN Events as the instrument’s state changes. Specifically, it can notify other devices as the status signals WaitingForTrigger, Sweeping, Measuring, OperationComplete, and Recalling transition. Additionally, Output LAN Events can be sent in response to the receipt of any of the Input LAN Events.

This is the entry point for the LXI Output LAN Event system. This key branches to a list of events that can be sent out on the LAN in response to instrument events.

Key Path	System, I/O Config, LXI
Initial S/W Revision	Prior to A.02.00

Disable All

This command causes the Enable property of all members of the LXI Output LAN Event List to be set to OFF.

Key Path	System, I/O Config, LXI, LXI Output LAN Events
----------	---

Remote Command	:LXI:EVENT[:OUTPut]:LAN:DISable:ALL
Example	:LXI:EVEN:LAN:DIS:ALL
Initial S/W Revision	Prior to A.02.00

Output LAN Event List

This is the list of LXI Output LAN events that can be sent in response to an instrument event such as sweeping or waiting for a trigger. Each member of this list has a key in the LXI Output LAN Events panel. The list can grow and shrink in response to Add and Remove commands respectively. New pages must be added and removed automatically as the list size changes. Only the first 14 characters of an LXI Output LAN Event name are displayed on the key.

Key Path	System, I/O Config, LXI, LXI Output LAN Events
Remote Command	:LXI:EVENT[:OUTPut]:LAN:LIST?
Example	:LXI:EVEN:LAN:LIST? Returns the complete list of Output LAN Events which is, at minimum: "LAN0", "LAN1", "LAN2", "LAN3", "LAN4", "LAN5", "LAN6", "LAN7", "WaitingForTrigger", "Measuring", "Sweeping", "OperationComplete", "Recalling"
Preset	"LAN0", "LAN1", "LAN2", "LAN3", "LAN4", "LAN5", "LAN6", "LAN7", "WaitingForTrigger", "Measuring", "Sweeping", "OperationComplete", "Recalling"
Preset	Not affected by a Preset. The default values can be restored by pressing Restore Defs, Input/Output Settings. Preset/Default values: "LAN0", "LAN1", "LAN2", "LAN3", "LAN4", "LAN5", "LAN6", "LAN7", "WaitingForTrigger", "Measuring", "Sweeping", "OperationComplete", "Recalling"
State Saved	Saved in instrument state.
Readback Text	Displays the value of the LXI Output LAN Event Enabled parameter (Enabled Disabled). Also displays the value of the LXI Output LAN Event Source parameter (WaitingForTrig Sweeping Measuring OpComplete Recalling)
Initial S/W Revision	Prior to A.02.00

Add (Remote Command Only)

Adds the provided string to the list of possible LAN events to output as a response to instrument events. As new LAN events are added, keys are generated in the LXI Output LAN Events menu. New key panels are generated as the number of possible LAN events increases past a multiple of six, and the "More" keys are updated to reflect the new number of key panels in the LXI Output LAN Events menu.

Remote Command	:LXI:EVENT[:OUTPut]:LAN:ADD "LANEVENT"
Example	:LXI:EVEN:LAN:ADD "LANEVENT"

Notes	The maximum length of the string is 16 characters. Longer strings are concatenated and added to the LXI Output LAN Event list. No event is added if the LAN Event already exists.
State Saved	No
Range	Uppercase, Lowercase, Numeric, Symbol except for comma or semicolon
Initial S/W Revision	Prior to A.02.00

Remove (Remote Command Only)

Removes the provided string from the list of possible LAN events to output as a response to instrument events. As new LAN events are removed, keys are removed from the LXI Output LAN Events menu. Key panels are removed as the number of possible LAN events decreases past a multiple of six, and the “More” keys are updated to reflect the new number of key panels in the LXI Output LAN Events menu. Events from the default list cannot be removed.

Remote Command	:LXI:EVENT[:OUTPut]:LAN:REMOve[:EVENT] "LANEVENT"
Example	:LXI:EVEN:LAN:REM "LANEVENT"
Notes	The maximum length of the string is 16 characters. Longer strings are concatenated and the resulting LAN Event is removed from the LXI Output LAN Event list. Nothing happens if the LAN event was not introduced using the Add command.
State Saved	No
Range	Uppercase, Lowercase, Numeric, Symbol
Initial S/W Revision	Prior to A.02.00

Remove All (Remote Command Only)

Clears the list of custom LAN events (those introduced using the Add command) that are available to output as a response to instrument events. As new LAN events are removed, keys are removed from the LXI Output LAN Events menu. Key panels are removed as the number of possible LAN events decreases past a multiple of six, and the “More” keys are updated to reflect the new number of key panels in the LXI Output LAN Events menu.

Remote Command	:LXI:EVENT[:OUTPut]:LAN:REMOve:ALL
Example	:LXI:EVEN:LAN:REM:ALL
Notes	Only LAN Events added with the Add command are removed. Default events cannot be removed.
Initial S/W Revision	Prior to A.02.00

Source

Sets the instrument event that this LXI Output LAN event is tied to.

The possible instrument events are “WaitingForTrigger”, “Sweeping”, “Measuring”, “OperationComplete”, and “Recalling”.

The key is labeled with the value of the selected source.

For the instrument event specific LXI Output LAN Events “WaitingForTrigger,” “Sweeping,” “Measuring,” “OperationComplete,” and “Recalling,” this parameter is set to the corresponding source value and cannot be changed. For these events, the Source key does not appear.

WaitingForTrigger, Measuring, and Sweeping correspond to the standard trigger state machine activities for which they are named.

OperationComplete is low when a measurement operation is underway. For example, OperationComplete is low throughout a list sweep measurement, even though Sweeping, Measuring, and WaitingForTrigger will undergo a number of transitions. In this case, OperationComplete goes high when the entire list sweep is finished.

Recalling is high while the instrument is actively recalling a state.

Additionally, the Source parameter can be set to the name of any Input LAN Event. This causes the Output LAN Event to be sent upon receipt of the named Input LAN Event. There is no front panel support for these events.

The default list of available Input LAN Events is:

- “LAN0”
- “LAN1”
- “LAN2”
- “LAN3”
- “LAN4”
- “LAN5”
- “LAN6”
- “LAN7”

Key Path	System, I/O Config, LXI, LXI Output LAN Events, LAN[n]
Remote Command	:LXI:EVENT[:OUTPut]:LAN[:SET]:SOURCE "LANEVENT", "SourceEvent" :LXI:EVENT[:OUTPut]:LAN[:SET]:SOURCE? "LANEVENT"
Example	:LXI:EVEN:LAN:SOUR "LANEVENT","WaitingForTrigger"
Notes	The maximum length of the string is 45 characters.
Preset	"Sweeping" (The Output LAN Events "WaitingForTrigger", "Sweeping", "Measuring", "OperationComplete", and "Recalling" all have default source parameters that match their names)
Preset	Not affected by a Preset. The default values can be restored by pressing Restore Defs, Input/Output Settings. Preset/Default values: "Sweeping" (The Output LAN Events "WaitingForTrigger", "Sweeping", "Measuring", "OperationComplete", and "Recalling" all have default source parameters that match their names)
State Saved	Saved in instrument state.

System Functions

System

Range	“WaitingForTrigger” “Sweeping” “Measuring” “OperationComplete” “Recalling” “LAN0” “LAN1” “LAN2” “LAN3” “LAN4” “LAN5” “LAN6” “LAN7” any user-added Input LAN Event
Initial S/W Revision	Prior to A.02.00

Destination (Remote Command Only)

Outgoing LAN events are sent to the hosts enumerated in the destination expression. This expression takes the form of “host1:port1, host2:port2, ...” where port numbers are optional, and default to the IANA assigned TCP port (5044). To designate a UDP broadcast at the default port, set the destination string to “” or “ALL”. To designate a UDP broadcast at a specific port, set the destination string to “:port” or “ALL:port”.

Examples:

- “192.168.0.1:23”
- “agilent.com, soco.agilent.com”
- “agilent.com:80, 192.168.0.1”

Remote Command	:LXI:EVENT[:OUTPut]:LAN[:SET]:DESTination “LANEVENT”, “destinationExpression” :LXI:EVENT[:OUTPut]:LAN[:SET]:DESTination? “LANEVENT”
Example	:LXI:EVEN:LAN:DEST “LANEVENT”, “host1, 192.168.0.1:80”
Notes	The maximum length of the string is 45 characters.
Preset	“ALL”
Preset	Not affected by a Preset. The default value of “ALL” can be restored by using the command: :SYSTem:DEFault INPut
State Saved	Saved in instrument state.
Range	Uppercase, Lowercase, Numeric, Symbol
Initial S/W Revision	Prior to A.02.00

Drive

Determines the behavior of an output event.

- Normal designates typical operation, where both edges of the instrument event are transmitted,
- Off disables the LAN event.
- Wired-OR causes only one edge to be transmitted.

Key Path	System, I/O Config, LXI, LXI Output LAN Events, LAN[n]
Remote Command	:LXI:EVENT[:OUTPut]:LAN[:SET]:DRIVE “LANEVENT”, OFF NORMal WOR :LXI:EVENT[:OUTPut]:LAN[:SET]:DRIVE? “LANEVENT”

Example	:LXI:EVEN:LAN:DRIV "LANEVENT",WOR
Preset	NORMal
Preset	Not affected by a Preset. The default value of "NORMal" can be restored by using the command: :SYSTem:DEFault INPut
State Saved	Saved in instrument state.
Range	OFF NORMal WOR
Initial S/W Revision	Prior to A.02.00

Slope

Determines which instrument event transition results in a LAN packet being sent and whether or not that edge is inverted.

When the Drive parameter is set to Normal, a Slope of Negative causes both edges to be inverted before they are transmitted. A Positive Slope transmits the edges unaltered.

When the Drive parameter is set to WOR, only Positive edges are transmitted. When the Slope is Negative, a falling edge is inverted and sent as a rising edge. When the Slope is Positive, a rising edge is sent normally.

The following table illustrates the effects of the Slope and Drive parameters.

Instrument Event Edge	Slope Parameter	Drive Parameter	Action
0	Negative	Off	Not sent
0	Positive	Off	Not sent
1	Negative	Off	Not sent
1	Positive	Off	Not sent
0	Negative	Normal	1
0	Positive	Normal	0
1	Negative	Normal	0
1	Positive	Normal	1
0	Negative	Wired OR	1
0	Positive	Wired OR	Not sent
1	Negative	Wired OR	Not sent
1	Positive	Wired OR	0

Key Path	System, I/O Config, LXI, LXI Output LAN Events, LAN[n]
----------	--

Remote Command	:LXI:EVENT[:OUTPut]:LAN[:SET]:SLOPe "LANEVENT", POSitive NEGative :LXI:EVENT[:OUTPut]:LAN[:SET]:SLOPe? "LANEVENT"
Example	:LXI:EVEN:LAN:SLOP "LANEVENT",POS
Preset	POSitive
Preset	Not affected by a Preset. The default value of "Positive" can be restored by using the command: :SYSTem:DEFault INPut
State Saved	Saved in instrument state.
Range	POSitive NEGative
Initial S/W Revision	Prior to A.02.00

Timestamp Delta

This parameter represents a time in seconds to add to the timestamp of the Output LAN Event. This timestamp delta allows the receiving instrument to delay its response until the time specified in the timestamp.

Key Path	System, I/O Config, LXI, LXI Output LAN Events, LAN[n]
Remote Command	:LXI:EVENT[:OUTPut]:LAN[:SET]:TSDelta "LANEVENT", <seconds> :LXI:EVENT[:OUTPut]:LAN[:SET]:TSDelta? "LANEVENT"
Example	:LXI:EVEN:LAN:TSD "LANEVENT",10.5 s
Preset	0.0 s
Preset	Not affected by a Preset. The default value of "0.0 s" can be restored by using the command: :SYSTem:DEFault INPut
State Saved	Saved in instrument state.
Range	0.0 – 1.7976931348623157 x 10308 s(Max Double)
Initial S/W Revision	Prior to A.02.00

Enabled

If this parameter is set to ON, this LAN Event is sent when the selected Source instrument event occurs.

Otherwise, this LAN Event is never output.

Key Path	System, I/O Config, LXI, LXI Output LAN Events, LAN[n]
Remote Command	:LXI:EVENT[:OUTPut]:LAN[:SET]:ENABled "LANEVENT", ON OFF 1 0 :LXI:EVENT[:OUTPut]:LAN[:SET]:ENABled? "LANEVENT"

Example	:LXI:EVENT:LAN:ENAB "LAN0",ON
Preset	OFF
Preset	Not affected by a Preset. The default value of "OFF" can be restored by using the command: :SYSTEM:DEFAULT INPUT
State Saved	Saved in instrument state.
Range	OFF ON 0 1
Initial S/W Revision	Prior to A.02.00

Count (Remote Command Only)

Returns the number of items in the LXI Output LAN Event List.

Remote Command	:LXI:EVENT[:OUTPUT]:LAN:COUNT?
Example	:LXI:EVENT:LAN:COUN?
Initial S/W Revision	Prior to A.02.00

Configure (Remote Command Only)

Allows the configuration of some parameters from a single SCPI command.

Remote Command	:LXI:EVENT[:OUTPUT]:LAN[:SET]:CONFIGURE "lanEvent", <enabled>, <source>, <slope>, <drive>, <destination>
Example	:LXI:EVENT:LAN:CONF "LAN0",1,"WaitingForTrigger",POS,NORM,"ALL"
Initial S/W Revision	Prior to A.02.00

Send (Remote Command Only)

Forces the instrument to send the requested LAN Event. The LAN Event must be enabled, otherwise this command is ignored.

Remote Command	:LXI:EVENT[:OUTPUT]:LAN:SEND "LANEVENT" , RISE FALL
Example	:LXI:EVENT:LAN:SEND "LANEVENT", FALL
Initial S/W Revision	Prior to A.02.00

Identifier (Remote Command Only)

Sets the string that will be placed in the peer-to-peer packet when the Output LAN Event is transmitted. The Identifier is variable to allow for easier system debugging. The Identifier must be unique, for example the "LAN0"

System Functions

System

and “LAN1” output events cannot have identical identifiers.

Remote Command	:LXI:EVENT[:OUTPut]:LAN[:SET]:IDENTifier "LANEVENT", "identifier" :LXI:EVENT[:OUTPut]:LAN[:SET]:IDENTifier? "LANEVENT"
Example	:LXI:EVENT:LAN:IDEN"LAN0","debugstring"
Notes	The maximum length of the string is 16 characters. Nothing happens if the LAN event does not exist. The default value is that the identifier is equivalent to the name of the LAN Event.
State Saved	Saved in instrument state.
Range	Uppercase, Lowercase, Numeric, Symbol
Initial S/W Revision	Prior to A.02.00

System IDN Response

This key allows you to specify a response to the *IDN? query, or to return the analyzer to the Factory response if you have changed it.

To choose the factory-set response, press the **Factory** key.

To specify your own response, press the **User** key, and enter your desired response.

Key Path	System, Config I/O
Mode	All
Remote Command	:SYSTEM:IDN <string> :SYSTEM:IDN?
Notes	<ul style="list-style-type: none"> This affects the response given in all Modes of the Analyzer, unless the current Mode has also specified a custom response, in which case the current Mode's custom IDN response takes precedence over the System's, but only while that Mode is the current Mode.. It survives shutdown and restart of the software and therefore survives a power cycle Null string as parameter restores the Factory setting
Preset	This is unaffected by Preset but is set to the original factory setting on a “Restore System Defaults->Misc”
State Saved	No
Initial S/W Revision	A.06.00

Factory

This key selects the factory setting, for example:

“Agilent Technologies,N9020A,MY00012345,A.05.01”

where the fields are manufacturer, model number, serial number, firmware revision.

Key Path	System, I/O Config, IDN Response
Example	:SYST:IDN "" null string, restores the factory setting
Initial S/W Revision	A.06.0

User

This key allows you to specify your own response to the *IDN? query. You may enter your desired response with the Alpha Editor or a plugin PC keyboard.

When you press this key, the active function becomes the current User string with the cursor at the end. This makes it easy to edit the existing string.

If you enter a null string (for example, by clearing the User String while editing and then pressing **Done**) the analyzer automatically reverts to the Factory setting.

Key Path	System, I/O Config, IDN Response
Example	:SYST:IDN “XYZ Corp,Model 12,012345,A.01.01” user specified response
Initial S/W Revision	A.06.00

Query USB Connection (Remote Command Only)

Enables you to determine the speed of the USB connection.

Mode	All
Remote Command	:SYSTem:COMMunicate:USB:CONNecion?
Example	:SYST:COMM:USB:CONN?
Notes	<p>NONE – Indicates no USB connection has been made.</p> <p>LSPeed – Indicates a USB low speed connection (1.5 Mbps).</p> <hr/> <p>NOTE This is reserved for future use, the T+M488 protocol is not supported on low speed connections</p> <hr/> <p>HSPeed – Indicates that a USB high speed connection (480 Mbps) has been negotiated.</p> <p>FSPeed – Indicates that a USB full speed connection (12 Mbps) has been negotiated.</p>
State Saved	No
Range	NONE LSPeed HSPeed FSPeed
Initial S/W Revision	Prior to A.02.00

USB Connection Status (Remote Command Only)

Enables you to determine the current status of the USB connection.

Mode	All
Remote Command	:SYSTem:COMMunicate:USB:STATus?
Example	:SYST:COMM:USB:STAT?
Notes	<p>SUSPended – Indicates that the USB bus is currently in its suspended state. The bus is in the suspended state when:</p> <ul style="list-style-type: none"> The bus is not connected to any controller The controller is currently powered off The controller has explicitly placed the USB device into the suspended state. <p>When in the suspended state, no USB activity, including start of frame packets are received.</p> <p>ACTive – Indicates that the USB device is in the active state. When the device is in the active state, it is receiving periodic start of frames but it isn't necessarily receiving or transmitting data.</p>
State Saved	No
Range	SUSPended ACTive
Initial S/W Revision	Prior to A.02.00

USB Packet Count (Remote Command Only)

Enables you to determine the number of packets received and transmitted on the USB bus.

Mode	All
Remote Command	:SYSTem:COMMunicate:USB:PACKets?
Example	:SYST:COMM:USB:PACK?
Notes	<p>Two integers are returned. The first is the number of packets received since application invocation, the second is the number of packets transmitted since application invocation. If no packets have been received or transmitted the response is 0,0.</p> <p>The packet count is initialized to 0,0 when the instrument application is started.</p>
State Saved	No
Initial S/W Revision	Prior to A.02.00

IEEE 1588 Time (Remote Command Only)

Time

Epoch Time (Remote Command Only)

If the device is selected as the IEEE 1588 master clock, this sets the clock using the number of seconds elapsed since January, 1 1970 at 00:00:00 in International Atomic Time (TAI). Epoch time is time zone invariant. Otherwise, this allows the user to query the epoch time.

Remote Command	:LXI:CLOCK[:TIME][:VALUE] <seconds>, <fractionalSeconds>
Example	:LXI:CLOC 10020304.0 s,0.123456 s
Notes	The seconds argument must only contain values representing whole seconds. For example 1243.0 s is acceptable, but 1243.01 results in an error. Ignored when the device is not selected as the IEEE 1588 master clock. The fractional portion is only accurate to the microseconds position. Error generated if the seconds argument contains a fractional portion.
Preset	System time
Preset	Not affected by a Preset. The default value of "System Time" can be restored by using the command: :SYSTEM:DEFAULT INPUT
State Saved	No
Range	Seconds: 0.0 – 1.7976931348623157 x 10308 s (Max Double) Fraction: 0.0 s – 0.999999 s
Initial S/W Revision	Prior to A.02.00

Remote Command	:LXI:CLOCK[:TIME][:VALUE] ?
Example	:LXI:CLOC?
Notes	The seconds argument must only contain values representing whole seconds. For example 1243.0 s is acceptable, but 1243.01 results in an error. Ignored when the device is not selected as the IEEE 1588 master clock. The fractional portion is only accurate to the microseconds position. Error generated if the seconds argument contains a fractional portion.
Preset	System time
State Saved	No
Range	Seconds: 0.0 – 1.7976931348623157 x 10308 s (Max Double) Fraction: 0.0 s – 0.999999 s
Initial S/W Revision	Prior to A.02.00

Seconds (Remote Command Only)

If the device is selected as the IEEE 1588 master clock, this sets the seconds portion of the clock. Otherwise, this allows the user to query the seconds portion of the epoch time. Valid values are in discrete increments of whole seconds.

Remote Command	:LXI:CLOCK[:TIME]:SECONDS <seconds> :LXI:CLOCK[:TIME]:SECONDS?
Example	:LXI:CLOC:SEC 10020304.0
Notes	Ignored when the device is not selected as the IEEE 1588 master clock. Error generated if the argument contains a fractional portion. For example 1243.0 s is acceptable, but 1243.01 results in an error.
Preset	System time
Preset	Not affected by a Preset. The default value of "System Time" can be restored by using the command: :SYSTEM:DEFAULT INPUT
State Saved	No
Range	0.0 – 1.7976931348623157 x 10308 s (Max Double)
Initial S/W Revision	Prior to A.02.00

Fraction (Remote Command Only)

If the device is selected as the IEEE 1588 master clock, this sets the sub-second value of the clock. Otherwise, this allows the user to query the sub-second value of the epoch time.

Remote Command	:LXI:CLOCK[:TIME]:FRACTION <fraction> :LXI:CLOCK[:TIME]:FRACTION?
Example	:LXI:CLOC:FRAC 10 ms
Notes	Ignored when the device is not selected as the IEEE 1588 master clock. Only accurate to the microseconds position.
Preset	Sub-second value of system time
State Saved	No
Range	[0.0,1.0)
Initial S/W Revision	Prior to A.02.00

Local Time (Remote Command Only)

Returns the current local time formatted as a date time string.

Remote Command	:LXI:CLOCK[:TIME]:LOCAL?
Example	:LXI:CLOC:LOC? Returns "5/15/2007 6:23:34.123456"

Notes	LXI:CLOCK[:TIME]:LOCAL? Returns Any string constituting a valid date and time
Initial S/W Revision	Prior to A.02.00

Leap Second Offset (Remote Command Only)

Enables you to set the leap second offset between the UTC and TAI time standards.

Remote Command	:LXI:CLOCK[:TIME]:LSOFFSET <integer> :LXI:CLOCK[:TIME]:LSOFFSET?
Example	:LXI:CLOC:LSOF 55
Range	0 – 2147483647 (Max Integer)
Initial S/W Revision	Prior to A.02.00

International Atomic Time (Remote Command Only)

Retrieves the current time using the TAI format.

Remote Command	:LXI:CLOCK[:TIME]:TAI?
Example	:LXI:CLOC:TAI? "5/15/2007 6:23:34.123456"
Notes	:LXI:CLOCK[:TIME]:TAI? Returns Any string constituting a valid date and time
Initial S/W Revision	Prior to A.02.00

Time Zone (Remote Command Only)

Retrieves the current local time zone as an offset in hours, minutes, and seconds from Greenwich Mean Time.

Remote Command	:LXI:CLOCK[:TIME]:TZON?
Example	:LXI:CLOC:TZON?
Notes	:LXI:CLOC:TZON? returns "01:00:00" if the current local time zone is 1 hour ahead from Greenwich Mean Time
Initial S/W Revision	Prior to A.02.00

Daylight Savings (Remote Command Only)

Retrieves the current status of the Windows System setting for Daylight Savings Time. Whether or not daylight savings time is in effect influences the time zone parameter.

Remote Command	:LXI:CLOCK[:TIME]:DLSavings?
Example	:LXI:CLOC:DLS?
Notes	:LXI:CLOC:DLS? Returns 1 when Daylight Savings Time is On and 0 if the when Daylight Savings Time is Off

System Functions
System

Preset	The Windows system Daylight Savings setting.
Initial S/W Revision	Prior to A.02.00

Coordinated Universal Time (Remote Command Only)

Retrieves the current time using the UTC format.

Remote Command	:LXI:CLOCK[:TIME]:UTC?
Example	:LXI:CLOC:UTC? "5/15/2007 6:23:34.123456"
Notes	:LXI:CLOC:UTC? Returns Any string constituting a valid date and time
Initial S/W Revision	Prior to A.02.00

Time Marker (Remote Command Only)

Records the PTP time as a marker that can later be measured against the current PTP time. Typical use is to time the length of a sequence of instrument operations. There are 9 available markers with indices 1 – 9.

Remote Command	:LXI:CLOCK[:TIME]:MARKer[1] 2 3 4 5 6 7 8 9[:SET]
Example	:LXI:CLOC:MARK1 :LXI:CLOC:MARK2 :LXI:CLOC:MARK3 :LXI:CLOC:MARK4 :LXI:CLOC:MARK5 :LXI:CLOC:MARK6 :LXI:CLOC:MARK7 :LXI:CLOC:MARK8 :LXI:CLOC:MARK9 :LXI:CLOC:MARK
Initial S/W Revision	Prior to A.02.00

Time Marker Clear (Remote Command Only)

Clears the recorded PTP time marker used to measure against the current PTP time. There are 9 available markers with indices 1 – 9.

Remote Command	:LXI:CLOCK[:TIME]:MARKer[1] 2 3 4 5 6 7 8 9:CLEAR
-----------------------	---

Example	:LXI:CLOC:MARK1:CLEA :LXI:CLOC:MARK2:CLEA :LXI:CLOC:MARK3:CLEA :LXI:CLOC:MARK4:CLEA :LXI:CLOC:MARK5:CLEA :LXI:CLOC:MARK6:CLEA :LXI:CLOC:MARK7:CLEA :LXI:CLOC:MARK8:CLEA :LXI:CLOC:MARK9:CLEA :LXI:CLOC:MARK:CLEA
Initial S/W Revision	Prior to A.02.00

Time Marker Delta (Remote Command Only)

Calculates and returns the delta time from the marker to the present PTP time. Also returns the seconds and sub-seconds portions of the start and end times. There are 9 available markers with indices 1 – 9.

Remote Command	:LXI :CLOCK[:TIME] :MARKer [1] 2 3 4 5 6 7 8 9 :DELTA?
Example	:LXI:CLOC:MARK1:DELT? returns <deltaTime>,<startSeconds>,<startFractionalSeconds>,<endSeconds>,<endFractionalSeconds> :LXI:CLOC:MARK2:DELT? :LXI:CLOC:MARK3:DELT? :LXI:CLOC:MARK4:DELT? :LXI:CLOC:MARK5:DELT? :LXI:CLOC:MARK6:DELT? :LXI:CLOC:MARK7:DELT? :LXI:CLOC:MARK8:DELT? :LXI:CLOC:MARK9:DELT? :LXI:CLOC:MARK:DELT?
Notes	:LXI:CLOCK[:TIME]:MARKer[1] 2 3 4 5 6 7 8 9:DELTA? Returns a value between 0.0 – 1.7976931348623157 x 10308 s (Max Double)
Range	0.0 – 1.7976931348623157 x 10308 s (Max Double)
Initial S/W Revision	Prior to A.02.00

Measurement Data Timestamp (Remote Command Only)

Returns the beginning and ending times of the last measurement cycle. This command also returns the duration of the measurement cycle. These values correspond to the last rising and falling transition of the Measuring

instrument event.

Remote Command	:LXI:CLOCK[:TIME]:MEASURE[:DELTA]?
Example	:LXI:CLOC:MEAS? Returns 2.0,1145902.0,0.123456, ,1145904.0,0.123456
Notes	:LXI:CLOCK[:TIME]:MARKER[1] 2 3 4 5 6 7 8 9:DELTA? Returns a value between 0.0 – 1.7976931348623157 x 10308 s (Max Double)
Initial S/W Revision	Prior to A.02.00

Clear Measurement Data Timestamp (Remote Command Only)

Forces the return values of the Measurement Data Timestamp to zero until the next measurement cycle occurs. This command need not be issued for the Measurement Data Timestamp to be refreshed.

Remote Command	:LXI:CLOCK[:TIME]:MEASURE:CLEAR
Example	:LXI:CLOC:MEAS:CLEAR
Initial S/W Revision	Prior to A.02.00

Precision Time Protocol

Precision Time Protocol, as defined by IEEE 1588, is a method for synchronizing the time across a network. Instruments participating in the PTP network can coordinate activities using this common time base.

Accuracy (Remote Command Only)

Sets the typical offset from the correct time that a user can expect from the instrument PTP clock. This parameter is used when the instrument is selected as the Master clock. It should be set along with the time when configuring a master clock.

The value should be chosen by judging how precisely the clock can be set to the exact TAI time and the accuracy and drift of the clock's underlying oscillator.

This is an input to the IEEE 1588 Best Master Clock algorithm.

Remote Command	:LXI:CLOCK:PTP:ACCURACY NS25 NS100 NS250 NS1000 NS2500 US10 US25 US100 US250 US1000 US2500 MS10 MS25 MS100 MS1000 S10 GT10S UNKNOWN :LXI:CLOCK:PTP:ACCURACY?
Example	:LXI:CLOC:PTP:ACC US25
Preset	GT10S
Preset	Not affected by a Preset. The default value of "GT10S" can be restored by using the command: SYSTEM:DEFAULT INPUT
Range	NS25 NS100 NS250 NS1000 NS2500 US10 US25 US100 US250 US1000 US2500 MS10 MS25 MS100 MS1000 S10 GT10S UNKNOWN
Initial S/W Revision	Prior to A.02.00

Announce Interval (Remote Command Only)

Sets the time in seconds between PTP announce packets. A shorter interval makes the system more responsive to changes in the master clock at the cost of network bandwidth and packet processing time. The announce interval should be constant across all the instruments in the network. The announce interval will be rounded to the nearest non-negative integer power of two, with a maximum value of 16.

Remote Command	:LXI:CLOCK:PTP:ANNOUNCE:INTERVAL <interval> :LXI:CLOCK:PTP:ANNOUNCE:INTERVAL?
Example	:LXI:CLOC:PTP:ANN:INT 1
Preset	2
Preset	Not affected by a Preset. The default value of "4" can be restored by using the command: SYSTem:DEFault INPut
Range	1 2 4 8 16
Initial S/W Revision	Prior to A.02.00

Announce Receipt Time Out (Remote Command Only)

Sets the number of announce intervals that the instrument waits to receive an announce packet while in the Slave or Listening. After this number of announce intervals, the instrument will transition to the Master state.

Remote Command	:LXI:CLOCK:PTP:ANNOUNCE:RTOUT <numberOfIntervals> :LXI:CLOCK:PTP:ANNOUNCE:RTOUT?
Example	:LXI:CLOC:PTP:ANN:RTO 5
Preset	3
Preset	Not affected by a Preset. The default value of "3" can be restored by using the command: SYSTem:DEFault INPut
Min	2
Max	10
Initial S/W Revision	Prior to A.02.00

Clock Class (Remote Command Only)

Returns a ranking of the master clock suitability relative to other clocks on the network. A lower value represents a more suitable clock.

Suitability is defined by the IEEE 1588 standard section 7.6.2.4

Remote Command	:LXI:CLOCK:PTP:CCLASS?
Example	:LXI:CLOC:PTP:CCL?

System Functions
System

Preset	248
Preset	Not affected by a Preset. The default value of "248" can be restored by using the command: SYSTem:DEFault INPut
Min	6
Max	248
Initial S/W Revision	Prior to A.02.00

Deviation (Remote Command Only)

Returns the standard deviation of the instrument's PTP time from the Grandmaster's PTP time.

Remote Command	:LXI:CLOCK:PTP:DEVIation?
Example	:LXI:CLOC:PTP:DEV?
Initial S/W Revision	Prior to A.02.00

Domain (Remote Command Only)

The instrument synchronizes its clock only with other clocks in the same domain.

Remote Command	:LXI:CLOCK:PTP:DOMain <domainNumber> :LXI:CLOCK:PTP:DOMain?
Example	:LXI:CLOC:PTP:DOM 0
Preset	0
Preset	Not affected by a Preset. The default value of "0" can be restored by using the command: SYSTem:DEFault INPut
Min	0
Max	127
Initial S/W Revision	Prior to A.02.00

Offset (Remote Command Only)

Returns the difference between the instrument clock PTP time and the Master clock PTP time.

Remote Command	:LXI:CLOCK:PTP:OFFSet?
Example	:LXI:CLOC:PTP:OFFS?
Range	0.0 to - 1.7976931348623157 x 10308 s (Min Double)
Initial S/W Revision	Prior to A.02.00

First Priority (Remote Command Only)

Setting this parameter overrides the IEEE 1588 Best Master Clock algorithm. If an instrument's First Priority parameter is smaller than all other clocks in its domain, it is chosen as the Master clock.

Remote Command	:LXI:CLOCK:PTP:PRIOriTY:FIRSt <priority> :LXI:CLOCK:PTP:PRIOriTY:FIRSt?
Example	:LXI:CLOC:PTP:PRI:FIRS 50
Preset	128
Preset	Not affected by a Preset. The default value of "128" can be restored by using the command: SYSTem:DEFault INPut
Min	0
Max	255
Initial S/W Revision	Prior to A.02.00

Second Priority (Remote Command Only)

When two or more clocks are determined to be equally good by the Best Master Clock algorithm, the clock with the lowest Second Priority value is chosen to be the Master Clock.

Remote Command	:LXI:CLOCK:PTP:PRIOriTY:SECOnd <priority> :LXI:CLOCK:PTP:PRIOriTY:SECOnd?
Example	:LXI:CLOC:PTP:PRI:SEC 50
Preset	128
Preset	Not affected by a Preset. The default value of "128" can be restored by using the command: SYSTem:DEFault INPut
Min	0
Max	255
Initial S/W Revision	Prior to A.02.00

State (Remote Command Only)

Returns the current state of the instrument's PTP clock as defined in the IEEE 1588 standard.

Remote Command	:LXI:CLOCK:PTP:STATe?
Example	:LXI:CLOC:PTP:STAT?
Range	INITializing FAULty DISabled LISTening PREMaster MASTer PASSive UNCalibrated SLAVE
Initial S/W Revision	Prior to A.02.00

Traceability (Remote Command Only)

Returns the quality of the instrument's PTP clock source of time when chosen as the Grand Master clock.

This parameter is used by the Best Master Clock algorithm.

Remote Command	:LXI:CLOCK:PTP:TRACeability?
Example	:LXI:CLOC:PTP:TRAC?
Range	ATOMic GPS RADio PTP NTP HANDset OTHer OSCillator
Initial S/W Revision	Prior to A.02.00

Variance (Remote Command Only)

Returns the variance of the instrument's PTP clock time relative to the Master's PTP clock time.

Remote Command	:LXI:CLOCK:PTP:VARiance?
Example	:LXI:CLOC:PTP:VAR?
Range	0.0 – 1.7976931348623157 x 10308 (Max Double)
Initial S/W Revision	Prior to A.02.00

Sync Interval (Remote Command Only)

Sets the rate at which PTP sync packets are transmitted when this instrument is acting as a Master PTP clock. The values must be integer powers of 2.

Remote Command	:LXI:CLOCK:PTP:SINTerval <seconds>
Example	:LXI:CLOC:PTP:SINT 0.25s
Preset	1
Preset	Not affected by a Preset. The default value of "1" can be restored by using the command: SYSTem:DEFault INPut
Range	0.0625s 0.125s 0.25s 0.5s 1s 2s
Initial S/W Revision	Prior to A.02.00

Remote Command	:LXI:CLOCK:PTP:SINTerval?
Example	:LXI:CLOC:PTP:SINT?
Preset	1
Range	0.0625s 0.125s 0.25s 0.5s 1s 2s
Initial S/W Revision	Prior to A.02.00

Delay Request Interval (Remote Command Only)

This property is used by the master clock to specify the interval between delay request packets sent from the slave to the master clock. Slaves use a randomly-chosen interval, with mean equal to this property.

The value for this parameter must be an integer power of two.

Remote Command	:LXI:CLOCK:PTP:DRInterval <seconds>
Example	:LXI:CLOC:PTP:DRIN 15 ms
Preset	8 s
Preset	Not affected by a Preset. The default value of "8 s" can be restored by using the command: SYSTEM:DEFault INPut
Range	1 s 2 s 4 s 8 s 16 s 32 s
Initial S/W Revision	Prior to A.02.00

Remote Command	:LXI:CLOCK:PTP:DRInterval?
Example	:LXI:CLOC:PTP:DRIN 15 ms
Preset	8 s
Min	0.0 s
Max	$2^{32} = 4294967296$ s
Initial S/W Revision	Prior to A.02.00

Grand Master

In the IEEE 1588 the best clock in the system, as determined by the Best Master Clock algorithm, is chosen as the Grand Master clock. The Grand Master clock is the ultimate source of time which all other clocks attempt to synchronize to. If the network is limited to a single subnet, the Master clock and the Grand Master clock are synonymous.

If a network spans multiple subnets, boundary clocks must be utilized to segment the network. Each subnet then selects a Master Clock using the Best Master Clock algorithm. From this population of Master Clocks, the best clock is selected to be the Grand Master clock.

Accuracy (Remote Command Only)

Returns the relative accuracy of the Grand Master clock.

Remote Command	:LXI:CLOCK:PTP:GMASter:ACCuracy?
Example	:LXI:CLOC:PTP:GMAS:ACC? For example, this might return GT10S.
Range	25NS 100NS 250NS 1US 2.5US 10US 25US 100US 250US 1MS 2.5MS 10MS 25MS 100MS 1S 10S GT10S UNKNown
Initial S/W Revision	Prior to A.02.00

MAC Address (Remote Command Only)

Returns the Grand Master's MAC Address.

Remote Command	:LXI:CLOCK:PTP:GMASter:MADdRes?
Example	:LXI:CLOC:PTP:GMAS:MADD? For example, this might return "00-00-50-1e-ca-ad".
Range	Uppercase, Lowercase, Numeric, Symbol
Initial S/W Revision	Prior to A.02.00

Traceability (Remote Command Only)

Describes the quality of the Grand Master PTP clock's source of time.

Remote Command	:LXI:CLOCK:PTP:GMASter:TRACeability?
Example	:LXI:CLOC:PTP:GMAS:TRAC? For example, this might return OSC.
Range	ATOMic GPS RADio PTP NTP HANDset OTHer OSCillator
Initial S/W Revision	Prior to A.02.00

Master

Instruments on the same subnet use the Best Master Clock algorithm to select a Master clock. The Master clock is used as the basis for synchronization.

MAC Address (Remote Command Only)

Returns the Master's MAC Address.

Remote Command	:LXI:CLOCK:PTP:MASter:MADdRes?
Example	:LXI:CLOC:PTP:MAST:MADD?
Range	Uppercase, Lowercase, Numeric, Symbol
Initial S/W Revision	Prior to A.02.00

Servo Algorithm (Remote Command Only)

The Servo Algorithm parameters are considered advanced settings for tweaking IEEE 1588 performance.

Log (Remote Command Only)

The Servo Log records measurements of the offset between the instrument's PTP clock and the Master's PTP clock. It also records the packet travel time for Master-to-Slave and Slave-to-Master transactions.

Next (Remote Command Only)

Retrieves and removes the oldest entry from the Servo Log. The format for a servo log entry is as follows

Sample Index:	integer representing entry order
---------------	----------------------------------

Time Seconds:	seconds portion of the entry timestamp
Time Fraction:	sub-second portion of the entry timestamp
Offset Seconds:	offset between the instrument's PTP clock and the Master's PTP clock
Average Delay Seconds:	the average measured transmission delay
Master Delay Seconds:	Master-to-Slave packet travel time
Slave Delay Seconds:	Slave-to-Master packet travel time

Remote Command	:LXI:CLOCK:SALGORITHM:LOG[:NEXT]?
Example	:LXI:CLOC:SALG:LOG?
Range	Uppercase, Lowercase, Numeric, Symbol
Initial S/W Revision	Prior to A.02.00

Circular (Remote Command Only)

Sets the behavior for entries occurring while the Servo Log is full.

- If Circular is set to 1, incoming events overwrite the oldest events in the log.
- If Circular is set to 0, incoming events are discarded.

Remote Command	:LXI:CLOCK:SALGORITHM:LOG:CIRCULAR[:ENABLED] ON OFF 0 1 :LXI:CLOCK:SALGORITHM:LOG:CIRCULAR[:ENABLED]?
Example	:LXI:CLOC:SALG:LOG:CIRC 1
Preset	1
Preset	Not affected by a Preset. The default value of "1" can be restored by using the command: SYSTEM:DEFAULT INPUT
Range	ON OFF 0 1
Initial S/W Revision	Prior to A.02.00

Beginning Entry (Remote Command Only)

Sets or freezes the beginning entry of the log when in circular mode to the most recently added entry at the time of the command. This is so that the :LXI:EVENT:LOG:ENTRY? command has a reference entry for indexing individual entries in the log.

Remote Command	:LXI:CLOCK:SALGORITHM:LOG:CIRCULAR:FBENTRY
Example	LXI:CLOCK:SALG:LOG:CIRC:FBEN
Initial S/W Revision	Prior to A.02.00

Clear (Remote Command Only)

Clears all entries from the Servo Log.

Remote Command	:LXI:CLOCK:SALgorithm:LOG:CLear
Example	:LXI:CLOC:SALG:LOG:CLE
Initial S/W Revision	Prior to A.02.00

Count (Remote Command Only)

Returns the number of unread entries in the Servo Log.

Remote Command	:LXI:CLOCK:SALgorithm:LOG:COUNT?
Example	:LXI:CLOC:SALG:LOG:COUN?
Range	0 - IEEE 1588 Servo Log Size
Initial S/W Revision	Prior to A.02.00

Enabled (Remote Command Only)

- When the Servo Log is disabled, no events are recorded.
- When it is enabled, the Servo Log is active.

Remote Command	:LXI:CLOCK:SALgorithm:LOG:ENABLED ON OFF 0 1 :LXI:CLOCK:SALgorithm:LOG:ENABLED?
Example	:LXI:CLOC:SALG:LOG:ENAB 1
Preset	0
Preset	Not affected by a Preset. The default value of "0" can be restored by using the command: SYSTem:DEFault INPut
Range	ON OFF 0 1
Initial S/W Revision	Prior to A.02.00

Size (Remote Command Only)

Sets the maximum number of entries to store in the Servo Log.

Remote Command	:LXI:CLOCK:SALgorithm:LOG:SIZE <maxLogEntries> :LXI:CLOCK:SALgorithm:LOG:SIZE?
Example	:LXI:CLOC:SALG:LOG:SIZE 100
Preset	256

Preset	Not affected by a Preset. The default value of "256" can be restored by using the command: SYSTem:DEFault INPut
Min	0
Max	1024
Initial S/W Revision	Prior to A.02.00

All (Remote Command Only)

Non-destructively returns the entire contents of the Servo Log.

Remote Command	:LXI:CLOCK:SALGORITHM:LOG:ALL?
Example	:LXI:CLOC:SALG:LOG?
Range	Uppercase, Lowercase, Numeric, Symbol
Initial S/W Revision	Prior to A.02.00

Specific Entry (Remote Command Only)

Non-destructively returns a specifically indexed entry from within the Servo Log.

Remote Command	:LXI:CLOCK:SALGORITHM:LOG:ENTRY? <intIndex>
Example	:LXI:CLOC:SALG:LOG? 0 Returns the oldest entry in the Servo Log. Example of result : "1,1208978798,139644871,0.000000000,3.393600e+038,0.000000000,0.000000000,0.000000000"
Range	Uppercase, Lowercase, Numeric, Symbol
Initial S/W Revision	Prior to A.02.00

Statistics (Remote Command Only)

Returns the long-term statistics of the servo log that characterizes the performance of the instrument PTP clock's offset from the master PTP clock. The statistics include the following values:

- Number of samples (an integer)
- Mean offset (a double)
- Standard deviation of the offset (a double)
- Maximum offset (a double)
- Minimum offset (a double)

Remote Command	:LXI:CLOCK:SALGORITHM:LOG:STATISTICS[:DATA]?
Example	:LXI:CLOC:SALG:LOG:STAT? Example of result : "3643,0.000000000,0.000000000,0.000000000,0.000000000"

System Functions System

Initial S/W Revision	Prior to A.02.00
----------------------	------------------

Clear Statistics (Remote Command Only)

Resets the long-term servo performance statistics.

Remote Command	:LXI:CLOCK:SALGORITHM:LOG:STATISTICS:CLEAR
Example	:LXI:CLOCK:SALG:LOG:STAT? Example of result : "3643,0.000000000,0.000000000,0.000000000,0.000000000"
Initial S/W Revision	Prior to A.02.00

Asymmetry (Remote Command Only)

Sets the difference in seconds between the Master-to-Slave packet travel time and the Slave-to-Master packet travel time.

Remote Command	:LXI:CLOCK:SALGORITHM[:SET]:ASYMMETRY <seconds> :LXI:CLOCK:SALGORITHM[:SET]:ASYMMETRY?
Example	:LXI:CLOCK:SALG:ASYM 15 ns
Preset	Not affected by a Preset. The default value of "0.0 s " can be restored by using the command: SYSTEM:DEFAULT INPUT
Min	-1
Max	1
Initial S/W Revision	Prior to A.02.00

Coarse/Fine Threshold (Remote Command Only)

Determines when the PTP clock Servo algorithm uses the 'Fine' or 'Coarse' parameters for adjusting the instrument's PTP clock time. The threshold is measured against a running estimate of the servo variance.

Coarse mode causes a slave clock to converge with the master clock more quickly, but it is more sensitive to noise, while Fine mode filters out noise more effectively, but takes longer to converge.

Remote Command	:LXI:CLOCK:SALGORITHM[:SET]:CFTHRESHOLD <secondsSquared> :LXI:CLOCK:SALGORITHM[:SET]:CFTHRESHOLD?
Example	:LXI:CLOCK:SALG:CFTH 0.25
Preset	Not affected by a Preset. The default value of "1.0e-11 " can be restored by using the command: SYSTEM:DEFAULT INPUT
Min	0
Max	1

Initial S/W Revision	Prior to A.02.00
----------------------	------------------

Coarse Proportional Constant (Remote Command Only)

This constant is used by the servo when above the Coarse/Fine Threshold variance. Decreasing this constant causes the servo to become less responsive to both noise in the system and changes in the Master Clock's rate. Conversely, increasing this constant causes the servo to respond more energetically to both system noise and changes in the Master Clock's rate.

The ratio between the Proportional and Integral constants should remain roughly constant.

Remote Command	:LXI:CLOCK:SALGORITHM[:SET]:CPCONSTANT <servoConstant> :LXI:CLOCK:SALGORITHM[:SET]:CPCONSTANT?
Example	:LXI:CLOC:SALG:CPC 0.5
Preset	Not affected by a Preset. The default value of "0.4 " can be restored by using the command: SYSTEM:DEFAULT INPUT
Min	0
Max	1
Initial S/W Revision	Prior to A.02.00

Coarse Integral Constant (Remote Command Only)

This constant is used by the servo when above the Coarse/Fine Threshold variance. Decreasing this constant causes the servo to become less responsive to both noise in the system and changes in the Master Clock's rate. Conversely, increasing this constant causes the servo to respond more energetically to both system noise and changes in the Master Clock's rate.

The ratio between the Proportional and Integral constants should remain roughly constant.

Remote Command	:LXI:CLOCK:SALGORITHM[:SET]:CICONSTANT <servoConstant> :LXI:CLOCK:SALGORITHM[:SET]:CICONSTANT?
Example	:LXI:CLOC:SALG:CIC 0.5
Preset	Not affected by a Preset. The default value of "0.2 " can be restored by using the command: SYSTEM:DEFAULT INPUT
Min	0
Max	1
Initial S/W Revision	Prior to A.02.00

Fine Proportional Constant (Remote Command Only)

This constant is used by the servo when below the Coarse/Fine Threshold variance. Decreasing this constant causes the servo to become less responsive to both noise in the system and changes in the Master Clock's rate. Conversely, increasing this constant causes the servo to respond more energetically to both system noise and changes in the

System Functions

System

Master Clock's rate.

The ratio between the Proportional and Integral constants should remain roughly constant.

Remote Command	:LXI:CLOCK:SALGORITHM[:SET]:FPCONSTANT <servoConstant> :LXI:CLOCK:SALGORITHM[:SET]:FPCONSTANT?
Example	:LXI:CLOC:SALG:FPC 1
Preset	0.35
Min	0
Max	1
Initial S/W Revision	Prior to A.02.00
Preset/	Not affected by a Preset. The default value of "0.35 " can be restored by using the command: SYSTem:DEFault INPut

Fine Integral Constant (Remote Command Only)

This constant is used by the servo when below the Coarse/Fine Threshold variance. Decreasing this constant causes the servo to become less responsive to both noise in the system and changes in the Master Clock's rate. Conversely, increasing this constant causes the servo to respond more energetically to both system noise and changes in the Master Clock's rate.

The ratio between the Proportional and Integral constants should remain roughly constant.

Remote Command	:LXI:CLOCK:SALGORITHM[:SET]:FICONSTANT <servoConstant> :LXI:CLOCK:SALGORITHM[:SET]:FICONSTANT?
Example	:LXI:CLOC:SALG:FIC 0.6
Preset	Not affected by a Preset. The default value of "0.05" can be restored by using the command: SYSTem:DEFault INPut
Min	0
Max	1
Initial S/W Revision	Prior to A.02.00

Maximum Outlier Discard Count (Remote Command Only)

Sets the maximum number of outlier packets to ignore. After this maximum is exceeded, the next packet is accepted, regardless of whether or not it is flagged as an outlier.

Remote Command	:LXI:CLOCK:SALGORITHM[:SET]:OMAXIMUM <consecutiveSamples> :LXI:CLOCK:SALGORITHM[:SET]:OMAXIMUM?
Example	:LXI:CLOC:SALG:OMAX 3

Preset	Not affected by a Preset. The default value of "5" can be restored by using the command: SYSTem:DEFault INPut
Min	0
Max	25
Initial S/W Revision	Prior to A.02.00

Outlier Threshold (Remote Command Only)

Defines the threshold for determining whether a packet is considered a statistical outlier. If a sync or delay request is held up in a switch for a significant amount of time, the quality of synchronization will be perturbed. The servo ignores anything outside the outlier threshold. This parameter is expressed as a number of standard deviations from the currently measured average packet latency. Note that the value can be set to fractional standard deviations.

Remote Command	:LXI:CLOCK:SALGorithm[:SET]:OTHreshold <standardDeviations> :LXI:CLOCK:SALGorithm[:SET]:OTHreshold?
Example	:LXI:CLOC:SALG:OTHR 1.0
Preset	Not affected by a Preset. The default value of "5.0" can be restored by using the command: SYSTem:DEFault INPut
Min	0.25
Max	6.0
Initial S/W Revision	Prior to A.02.00

Outlier Threshold Enable (Remote Command Only)

Enables the outlier threshold to determine whether or not outliers are discarded.

Remote Command	:LXI:CLOCK:SALGorithm[:SET]:OTENable ON OFF 1 0 :LXI:CLOCK:SALGorithm[:SET]:OTENable?
Example	:LXI:CLOC:SALG:OTEN OFF
Preset	Not affected by a Preset. The default value of "OFF" can be restored by using the command: SYSTem:DEFault INPut
Initial S/W Revision	Prior to A.02.00

Set/Steer Threshold (Remote Command Only)

If the instrument's clock deviates from the master by an amount equal to or greater than this threshold, it is reset to

match the master rather than being gradually steered toward it.

Remote Command	:LXI:CLOCK:SALgorithm[:SET]:STHReshold <seconds> :LXI:CLOCK:SALgorithm[:SET]:STHReshold?
Example	:LXI:CLOC:SALG:STHR 15 ms
Preset	0.1 s
Preset	Not affected by a Preset. The default value of "0.1 s " can be restored by using the command: SYSTem:DEFault INPut
Min	0.0001
Max	10.0
Initial S/W Revision	Prior to A.02.00

Configure (Remote Command Only)

Allows the configuration of some of the above parameters from a single SCPI command.

Remote Command	:LXI:CLOCK:SALgorithm[:SET]:CONFigure <asymmetry>, <coarse fine threshold>, <cpc>, <cic>, <fpc>, <fic>, <maximum outlier discard>, <outlier threshold>, <set/steer threshold>
Example	:LXI:CLOC:SALG:CONF 0.0, 2.0E-13, 0.4, 0.2, 0.35, 0.05, 5, 2.0E-4, 0.1s
Initial S/W Revision	Prior to A.02.00

Synchronization (Remote Command Only)

Synchronization parameters are used to control the behavior of the LAN communication used to achieve converging times across the system.

Master (Remote Command Only)

Reports whether or not the device has been selected as the PTP master clock.

Remote Command	:LXI:CLOCK:SYNC:MASTer?
Example	:LXI:CLOC:SYNC:MAST?
Range	ON OFF 0 1
Initial S/W Revision	Prior to A.02.00

Local Enabled (Remote Command Only)

Enable steering of the local clock with the PTP IEEE 1588 clock.

Remote Command	:LXI:CLOCK:SYNC:LOCAL:ENABled ON OFF 0 1 :LXI:CLOCK:SYNC:LOCAL:ENABled?
-----------------------	--

Example	:LXI:CLOC:SYNC:LOC:ENAB ON
Preset	OFF
Preset	Not affected by a Preset. The default value of "ON" can be restored by using the command: SYSTem:DEFault INPut
Range	ON OFF 0 1
Initial S/W Revision	Prior to A.02.00

Local Interval (Remote Command Only)

The local clock is updated after the time set in the Local Interval elapses.

Remote Command	:LXI:CLOCK:SYNC:LOCAL:INTERVAL :LXI:CLOCK:SYNC:LOCAL:INTERVAL?
Example	:LXI:CLOC:SYNC:LOC:INT 60
Preset	60
Preset	Not affected by a Preset. The default value of "60 " can be restored by using the command: SYSTem:DEFault INPut
Min	0
Max	3600
Initial S/W Revision	Prior to A.02.00

Instrument Status Events

Instrument status events represent internal state changes that are important for synchronization. The recognized Status Events are:

WaitingForTrigger:	Transitions high when the measurement is awaiting a trigger event. Transitions low when the trigger event occurs or the measurement is aborted.
Sweeping:	Transitions high when the instrument begins sweeping. Transitions low when the sweep is completed.
Measuring:	Transitions high when measurement data is being recorded. Transitions low when measurement data is no longer being recorded.
OperationComplete:	Transitions low when a measurement operation is in progress. In some cases (for example, ListSweep), multiple sweeps are taken during a single measurement operation. Transitions high when the measurement operation is finished or aborted.
Recalling:	Transitions high while the instrument is recalling a previous state. Transitions low when a recall is not in progress.

Enable (Remote Command Only)

Setting the enabled parameter to ON enables the selected instrument event to be used as a source for Output LAN Events. Enabling an Instrument Status Event also causes the event to appear in the Event Log.

Remote Command	:LXI:EVENT:STATus[:ENABled] "STATUSEVENT",ON OFF 1 0
Example	:LXI:EVEN:STAT "WaitingForTrigger",1
Preset	ON
Preset	Not affected by a Preset. The default value of "1" can be restored by using the command, :SYSTem:DEFault INPut.
State Saved	Saved in instrument state.
Range	1 0 ON OFF
Initial S/W Revision	Prior to A.02.00

Remote Command	:LXI:EVENT:STATus[:ENABled]? "STATUSEVENT"
Example	:LXI:EVEN:STAT? "WaitingForTrigger" Returns 1 if previously enabled. Otherwise, returns 0.
Preset	ON
State Saved	Saved in instrument state.
Range	1 0 ON OFF
Initial S/W Revision	Prior to A.02.00

LXI State Recall

The LXI Event system can be used to recall states upon receipt of LXI Input LAN Events.

Location (Remote Command Only)

This parameter is used to store the file paths of the state files to be recalled when each Input LAN Event is received. Since each LAN Event has its own Location entry, a given state is capable of branching to at least 8 different states. If custom Input events are added, an even greater branching factor is possible.

When setting up state transitions, it is important to set the location of the next state before saving. This way, when the saved state is recalled, the next state locations are also automatically recalled.

Remote Command	:LXI:EVENT:INPut:LAN:LOCation "LANEVENT", "path"
Example	:LXI:EVEN:INP:LAN:LOC "LANEVENT", "c:\states\state01.state"
Notes	The maximum length of the string is 512 characters.
State Saved	Saved in instrument state.
Range	Uppercase, Lowercase, Numeric, Symbol
Initial S/W Revision	Prior to A.02.00

Remote Command	:LXI:EVENT:INPut:LAN:LOCation? "LANEVENT"
Example	:LXI:EVEN:INP:LAN:LOC? "LANEVENT" Returns "c:\states\state01.state" if that value was previously entered
Notes	The maximum length of the string is 512 characters.
State Saved	Saved in instrument state.
Range	Uppercase, Lowercase, Numeric, Symbol
Initial S/W Revision	Prior to A.02.00

Disable All (Remote Command Only)

Causes all LXI Input LAN Events to go into the disabled state (Enabled = OFF).

Remote Command	:LXI:EVENT:INPut:LAN:DISable:ALL
Example	:LXI:EVEN:INP:LAN:DIS:ALL
Initial S/W Revision	Prior to A.02.00

Add (Remote Command Only)

Adds the provided string to the list of possible LAN events to Input as a response to instrument events. As new LAN events are added, keys are generated in the LXI Input LAN Events menu. New key panels are generated as the number of possible LAN events increases past a multiple of six, and the "More" keys are updated to reflect the new number of key panels in the LXI Input LAN Events menu.

Remote Command	:LXI:EVENT:INPut:LAN:ADD "LANEVENT"
Example	:LXI:EVEN:INP:LAN:ADD "LANEVENT"
Notes	The maximum length of the string is 16 characters. Longer strings are concatenated and added to the LXI Input LAN Event list. No event is added if the LAN Event already exists.
State Saved	No
Range	Uppercase, Lowercase, Numeric, Symbol except for comma or semicolon
Initial S/W Revision	Prior to A.02.00

Remove (Remote Command Only)

Removes the provided string from the list of LXI Input LAN Events. As new LAN events are removed, keys are removed from the LXI Input LAN Events menu. Key panels are removed as the number of possible LAN events decreases past a multiple of six, and the "More" keys are updated to reflect the new number of key panels in the LXI Input LAN Events menu. Events from the default list cannot be removed.

Remote Command	:LXI:EVENT:INPut:LAN:REMOve [:EVENT] "LANEVENT"
Example	:LXI:EVEN:INP:LAN:REM "LANEVENT"

Notes	The maximum length of the string is 16 characters. Longer strings are concatenated and the resulting LAN Event is removed from the LXI Input LAN Event list. Nothing happens if the LAN event was not introduced using the Add command.
State Saved	No
Range	Uppercase, Lowercase, Numeric, Symbol
Initial S/W Revision	Prior to A.02.00

Remove All (Remote Command Only)

Clears the list of custom LAN events (those introduced using the Add command). As new LAN events are removed, keys are removed from the LXI Input LAN Events menu. Key panels are removed as the number of possible LAN events decreases past a multiple of six, and the “More” keys are updated to reflect the new number of key panels in the LXI Input LAN Events menu.

Remote Command	:LXI:EVENT:INPut:LAN:REMOve:ALL
Example	:LXI:EVEN:INP:LAN:REM:ALL
Notes	Only LAN Events added with the Add command are removed. Default events cannot be removed.
Initial S/W Revision	Prior to A.02.00

Filter (Remote Command Only)

Only LXI Input LAN Events coming from hosts matching the filter string are processed. There is no Key Path to this command

The syntax for specifying a filter is as follows:

Filter == ([host[:port]] | [ALL[:port]]) [,Filter]

Specifying an empty string means that LXI trigger packets are accepted as an Input from any port on any host on the network via either TCP or UDP.

Specifying only the port means that any host communicating over that port can send events.

Specifying ALL indicates that UDP multicast packets are accepted if they are directed to the IANA assigned multicast address on the IANA assigned default port, or the designated port if specified.

Examples:

- “192.168.0.1:23”
- “agilent.com, soco.agilent.com”
- “agilent.com:80, 192.168.0.1”
- The LXI:EVENT:INPut:LAN:FILTER command applies only to state events and will have no effect on trigger events, even when both are tied to the same event name (like "LAN0"). Similarly, the

TRIGger:LXI:LAN:FILTer command applies only to trigger events and will have no effect on state events.

Remote Command	:LXI:EVENT:INPut:LAN:FILTer "LANEVENT", "filterString" :LXI:EVENT:INPut:LAN:FILTer?
Example	:LXI:EVEN:INP:LAN:FILT "LAN0", "agilent.com" :LXI:EVEN:INP:LAN:FILT?
Notes	The maximum length of the string is 45 characters. Nothing happens if the LAN event does not exist.
State Saved	Saved in instrument state.
Range	Uppercase, Lowercase, Numeric, Symbol
Initial S/W Revision	Prior to A.02.00

Identifier (Remote Command Only)

Sets the string that is expected to arrive over the LAN for a given Input LAN Event to occur. The Identifier is variable to allow for easier system debugging.

Remote Command	:LXI:EVENT:INPut:LAN:IDENtifier "LANEVENT", "identifier" :LXI:EVENT:INPut:LAN:IDENtifier? "LANEVENT"
Example	:LXI:EVEN:INP:LAN:IDEN "LAN0", "debugstring"
Notes	The maximum length of the string is 16 characters. Nothing happens if the LAN event does not exist. The default value is that the identifier is equivalent to the name of the LAN Event.
State Saved	Saved in instrument state.
Range	Uppercase, Lowercase, Numeric, Symbol
Initial S/W Revision	Prior to A.02.00

Detection (Remote Command Only)

Selects the triggering option..

- Selecting "Rise" causes the instrument to trigger on the receipt of a signal low LAN Event followed by a signal high LAN Event.
- Selecting "Fall" causes the instrument to trigger on the receipt of a signal high LAN Event followed by a signal low LAN Event.
- Selecting "High" causes the instrument to trigger on every signal high LAN Event.
- Selecting "Low" causes the instrument to trigger on every signal low LAN Event.

Remote Command	:LXI:EVENT:INPut:LAN[:SET]:DETection "LANEVENT", HIGH LOW RISE FALL
-----------------------	--

System Functions
System

Example	:LXI:EVENT:INP:LAN:DET "LANEVENT",HIGH
Notes	If a non existent LAN event is passed in the lanEvent argument, the command is ignored
Preset	Not affected by a Preset. The default value of "HIGH" can be restored by using the remote command: :SYSTem:DEFault INPut
State Saved	Saved in instrument state.
Range	HIGH LOW RISE FALL
Readback Text	Currently selected detection type
Initial S/W Revision	Prior to A.02.00

Remote Command	:LXI:EVENT:INPut:LAN[:SET]:DETEction? "LANEVENT"
Example	:LXI:EVEN:INP:LAN:DET? "LANEVENT"
Notes	If a non existent LAN event is passed in the lanEvent argument, the command is ignored
Preset	HIGH
State Saved	Saved in instrument state.
Range	HIGH LOW RISE FALL
Readback Text	Currently selected detection type
Initial S/W Revision	Prior to A.02.00

Enabled (Remote Command Only)

When the Enabled parameter is set to ON, receiving the given LAN Event causes the instrument to transition to the state held in the Next State Slot.

When the Enabled parameter is OFF, the Input LAN Event is ignored.

Remote Command	:LXI:EVENT:INPut:LAN[:SET]:ENABLEd "LANEVENT",ON OFF 1 0
Example	:LXI:EVEN:INP:LAN:ENAB "LAN0",1
Preset	Not affected by a Preset. The default value of "OFF" can be restored by using the remote command: :SYSTem:DEFault INPut
State Saved	Saved in instrument state.
Range	1 0
Initial S/W Revision	Prior to A.02.00

Remote Command	:LXI:EVENT:INPut:LAN[:SET]:ENABled? "LANEVENT"
Example	:LXI:EVEN:INP:LAN:ENAB? "LAN0"
Preset	OFF
State Saved	Saved in instrument state.
Range	1 0
Initial S/W Revision	Prior to A.02.00

Count (Remote Command Only)

Returns the number of items in the LXI Input LAN Event List.

Remote Command	:LXI:EVENT:INPut:LAN:COUNT?
Example	:LXI:EVEN:INP:LAN:COUN?
Initial S/W Revision	Prior to A.02.00

List (Remote Command Only)

Returns a list of all of the valid LXI Input LAN Event names.

Remote Command	:LXI:EVENT:INPut:LAN:LIST?
Example	:LXI:EVEN:INP:LAN:LIST? Returns "LAN0", "LAN1", "LAN2", "LAN3", "LAN4", "LAN5", "LAN6", "LAN7"
Preset	"LAN0", "LAN1", "LAN2", "LAN3", "LAN4", "LAN5", "LAN6", "LAN7"
State Saved	Saved in instrument state.
Initial S/W Revision	Prior to A.02.00

Configure (Remote Command Only)

Allows the configuration of some of the above parameters from a single SCPI command.

Remote Command	:LXI:EVENT:INPut:LAN[:SET]:CONFigure "lanEvent" , <enab>, <detection>, <filter>, <identifier>
Example	:LXI:EVEN:INP:LAN:CONF "LAN0",1,FALL,"FILTER","DEBUG"
Initial S/W Revision	Prior to A.02.00

Restore Defaults

Provides incremental initialization of the system setting groups along with supporting a comprehensive reset of the entire instrument back to a factory default state. The menu selections are the groups of system settings and when one is selected, that particular group of system settings is reset back to their

System Functions
System

default values.

Key Path	System
Mode	All
Remote Command	:SYSTem:DEFault [ALL] ALIGn INPut MISC MODes PON
Example	SYST:DEF
State Saved	No
Initial S/W Revision	Prior to A.02.00

Restore Input/Output Defaults

Causes the group of settings and data associated with Input/Output front-panel key to be a reset to their default values. This level of Restore System Defaults does not affect any other system settings, mode settings and does not cause a mode switch. .

Confirmation is required to restore the Input/Output setting. The confirmation dialog is:

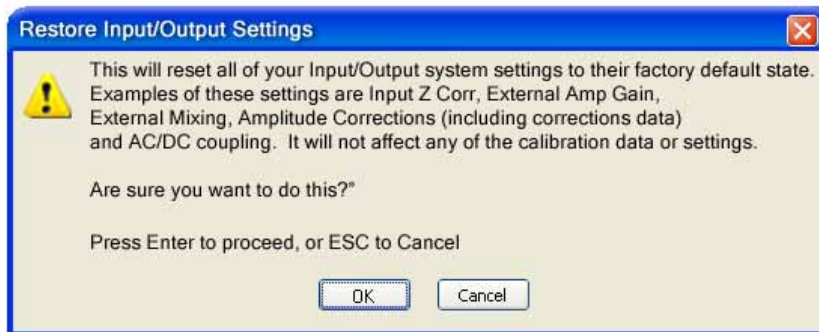

Key Path	System, Restore System Defaults
Example	:SYST:DEF INP
Initial S/W Revision	Prior to A.02.00

Restore Power On Defaults

This selection causes the Power On settings to be a reset to their default value. This level of Restore System Defaults does not affect any other system settings, mode settings and does not cause a mode switch. The Power On settings and their default values are Power On Type reset to Mode and Input/Output Defaults and Power On Application reset to whatever the factory set as its default value.

Confirmation is required to restore the factory default values. The confirmation dialog is:

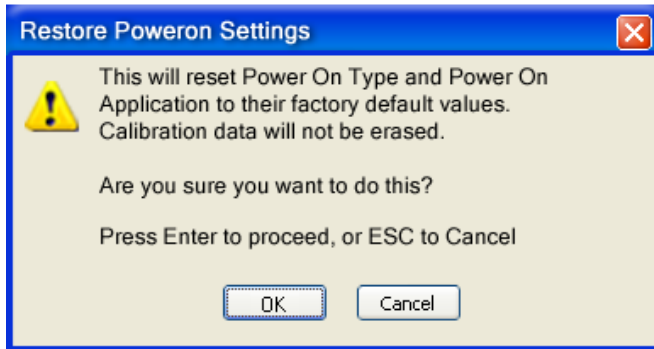

Key Path	System, Restore System Defaults
Example	:SYST:DEF PON
Initial S/W Revision	Prior to A.02.00

Restore Align Defaults

This selection causes the Alignment system settings to be a reset to their default values. This does not affect any Alignment data stored in the system. This level of Restore System Defaults does not affect any other system settings, mode settings and does not cause a mode switch.

After performing this function, it may impact the auto-alignment time of the instrument until a new alignment baseline has been established.

Confirmation is required to restore the factory default values. The confirmation dialog is:

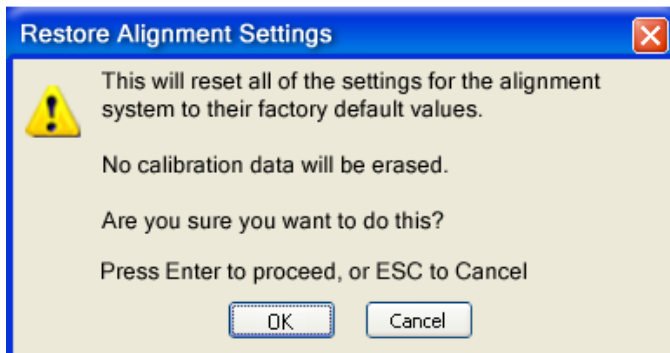

Key Path	System, Restore System Defaults
Example	:SYST:DEF ALIG
Initial S/W Revision	Prior to A.02.00

Restore Misc Defaults

This selection causes miscellaneous system settings to be reset to their default values. With this reset, you lose the GPIB address and it is reset to 18, so this should be used with caution. This level of Restore System Defaults does not affect any other system settings, mode settings and does not cause a mode

System Functions
System

switch. This miscellaneous group contains the rest of the settings that have not been part of the other Restore System Defaults groups. The following table is a complete list of settings associated with this group:

Miscellaneous Setting	Default Value
Verbose SCPI	Off
GPIB Address	18
Auto File Name Number	000
Save Type	State
State Save To	Register 1
Screen Save To	SCREEN000.png
DISP:ENABLE	ON
Full Screen	Off
SCPI Telnet	ON
SCPI Socket	ON
SICL Server	ON
Display Intensity	100
Display Backlight	ON
Display Theme	TDColor
System Annotation	ON
The SYST:PRES:TYPE	MODE

Confirmation is required to restore the factory default values. The confirmation dialog is:

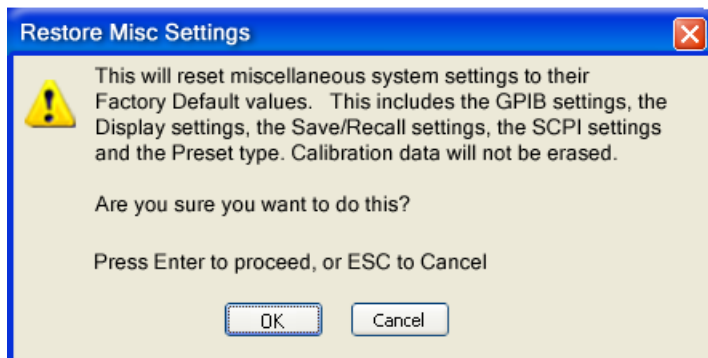

Key Path	System, Restore System Defaults
Example	:SYST:DEF MISC
Initial S/W Revision	Prior to A.02.00

Restore Mode Defaults (All Modes)

This selection resets all of the modes in the instrument back to their default state just as a Restore Mode Defaults does and it switches the instrument to the power-on mode and causes the default measurement for the power-on mode to be active. This level of Restore System Defaults does not affect any system settings, but it does affect the state of all modes and does cause a mode switch unless the instrument was already in the power-on mode.

Confirmation is required to restore the factory default values. The confirmation dialog is:

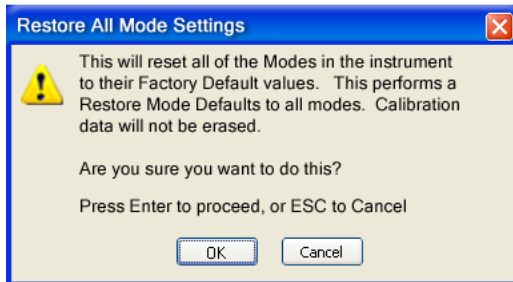

Key Path	System, Restore System Defaults
Example	:SYST:DEF MOD
Couplings	An All Mode will cause the currently running measurement to be aborted, mode switch to the power-on mode and activate the default measurement for the power-on mode.. It gets the mode to a consistent state with all of the default couplings set.
Initial S/W Revision	Prior to A.02.00

All

This is the catastrophic function that does a comprehensive reset of ALL analyzer settings to their factory default values. It resets all of the system setting groups, causes a Restore Mode Defaults for all modes in the instrument, and switches back to the power-on mode. It does not affect the User Preset file or any user saved files.

Confirmation is required to restore the factory default values. The confirmation dialog is:

System Functions

System

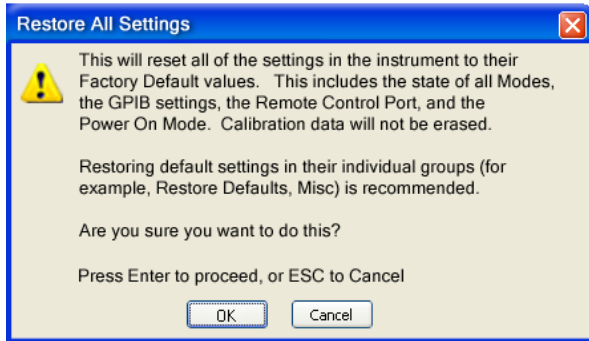

Key Path	System, Restore System Defaults
Example	:SYST:DEF ALL
Couplings	An All will cause the currently running measurement to be aborted and get all modes to a consistent state, so it is unnecessary to couple any settings.
Initial S/W Revision	Prior to A.02.00

Control Panel...

Opens the Windows Control Panel. The Control Panel is used to configure certain elements of Windows that are not configured through the hardkey/softkey System menus.

The Control Panel is a separate Windows application, so to return to the analyzer once you are in the Control Panel, you may either:

Exit the Control Panel by clicking on the red X in the upper right hand corner, with a mouse

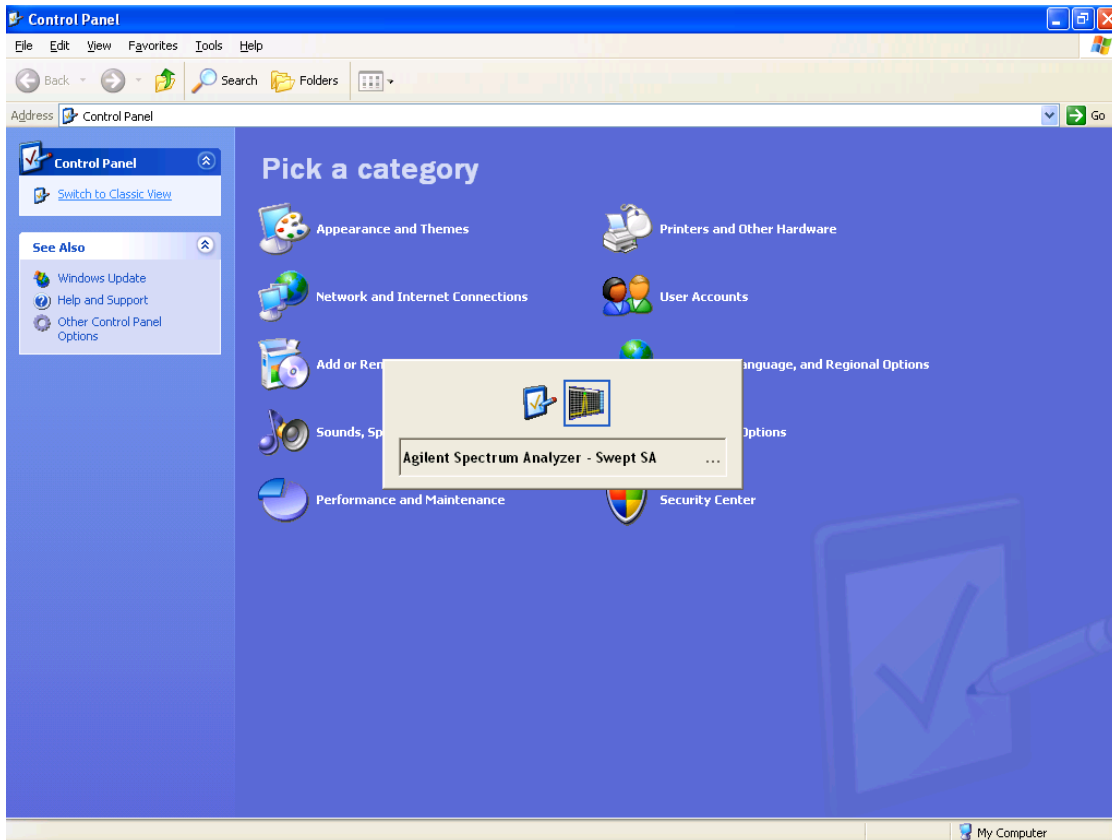

Or use Alt-Tab: press and hold the Alt  key and press and release the Tab key until the Analyzer logo is showing in the window in the center of the screen, as above, then release the Alt key.

Key Path	System
Notes	No remote command for this key.
Initial S/W Revision	Prior to A.02.00

Licensing...

Opens the license explorer.

For Help on this key, select Help in the menu bar at the top of the license explorer window.

Key Path	System
Notes	No equivalent remote command for this key.
Initial S/W Revision	Prior to A.02.00

Remote Command	:SYSTem:LKEY <"OptionInfo">, <"LicenseInfo">
-----------------------	--

System Functions
System

Example	SYST:LKEY "N9073A-1FP","027253AD27F83CDA5673A9BA5F427FDA5E4F25AEB1017638211AC9F60D9C639FE539735909C551DE0A91"
Notes	The <"OptionInfo"> contains the feature and the version. You must specify the feature but can omit the version. If you omit the version, the system regards it as the latest one, since the system knows which version is supported for each feature. The <"LicenseInfo"> contains the signature, the expiration date, and serial number for transport if transportable. You must specify the signature, but you can omit the other information. If you omit the expiration date, the system regards it as permanent. If you omit the serial number, the system regards it as non-transportable. As a result, this supports backward compatibility.
Initial S/W Revision	Prior to A.02.00

Remote Command	:SYSTem:LKEY:DELeTe <"OptionInfo" >,<"LicenseInfo" >
Example	SYST:LKEY:DEL "N9073A-1FP","027253AD27F83CDA5673A9BA5F427FDA5E4F25AEB1017638211AC9F60D9C639FE539735909C551DE0A91"
Notes	The <"OptionInfo"> contains the feature and the version. You must specify the feature but can omit the version. If you omit the version, the system regards it as the latest one, if more than one version is installed. The <"LicenseInfo"> contains the signature, the expiration date, and whether or not be transportable. You must specify the signature, but you can omit the other information. If you omit the expiration date, the system regards it as permanent. If you omit the transportability, the system regards it as non-transportable. As a result, this supports backward compatibility.
Initial S/W Revision	Prior to A.02.00

Remote Command	:SYSTem:LKEY:LIST?
-----------------------	--------------------

Notes	<p>Return Value:</p> <p>An <arbitrary block data> of all the installed instrument licenses.</p> <p>The format of each license is as follows.</p> <p><Feature>,<Version>,<Signature>,<Expiration Date>,<Serial Number for Transport></p> <p>Return Value Example:</p> <p>#3136</p> <p>N9073A-1FP,1.000,B043920A51CA</p> <p>N9060A-2FP,1.000,4D1D1164BE64</p> <p>N9020A-508,1.000,389BC042F920</p> <p>N9073A-1F1,1.000,5D71E9BA814C,13-aug-2005</p> <p><arbitrary block data> is:</p> <p>#NMMM<data></p> <p>Where:</p> <p>N is the number of digits that describes the number of MMM characters. For example if the data was 55 bytes, N would be 2.</p> <p>MMM would be the ASCII representation of the number of bytes. In the previous example, N would be 55.</p> <p><data> ASCII contents of the data</p>
Initial S/W Revision	Prior to A.02.00

Remote Command	:SYSTem:LKEY? <"OptionInfo" >
Example	SYST:LKEY? "N9073A-1FP"
Notes	<p>The <"OptionInfo"> contains the feature and the version. You must specify the feature but can omit the version. If you omit the version, the system regards it as the latest one.</p> <p>Return Value:</p> <p><"LicenseInfo"> if the license is valid, null otherwise.</p> <p><"LicenseInfo"> contains the signature, the expiration date, and serial number if transportable.</p> <p>Return Value Example:</p> <p>"B043920A51CA"</p>
Initial S/W Revision	Prior to A.02.00

Remote Command	:SYSTem:HID?
Notes	Return value is the host ID as a string
Initial S/W Revision	Prior to A.02.00

Security

Accesses capabilities for operating the instrument in a security controlled environment.

Key Path	System
Initial S/W Revision	A.04.00

USB

The Windows operating system can be configured to disable write access to the USB ports for users who are in a secure environment where transferring data from the instrument is prohibited. This user interface is a convenient way for the customer to disable write access to USB.

Key Path	System, Security
Mode	All
Scope	Mode Global
Remote Command	:SYSTem:SECurity:USB:WPRotect [:ENABLE] ON OFF 0 1 :SYSTem:SECurity:USB:WPRotect [:ENABLE] ?
Example	:SYST:SEC:USB:WPR ON Will set USB ports to Read-only
Notes	When the USB ports are in Read-only mode then no data can be stored to USB, including the internal USB memory used for a back-up location for the calibration data.
Dependencies	This key is grayed-out unless the current user has administrator privileges.
Preset	This is unaffected by Preset or any Restore System Defaults. An Agilent Recovery will set the USB to write protect OFF
State Saved	No
Range	Read-Write Read only
Initial S/W Revision	A.04.00

Read-Write

Selection for allowing full read-write access to the USB ports.

Key Path	System, Security, USB
Example	:SYST:SEC:USB:WPR OFF Will set USB ports to Read-Write
Initial S/W Revision	A.04.00

Read only

Selection for disabling write access to the USB ports.

Key Path	System, Security, USB
----------	------------------------------

Example	:SYST:SEC:USB:WPR ON	Will set USB ports to Read only
Initial S/W Revision	A.04.00	

Diagnostics

The Diagnostics key in the System menu gives you access to basic diagnostic capabilities of the instrument.

Key Path	System
Initial S/W Revision	Prior to A.02.00

Show Hardware Statistics

Provides a display of various hardware statistics. The statistics include the following:

- Mechanical relay cycles
- High and Low temperature extremes
- Elapsed time that the instrument has been powered-on (odometer)

The display should appear listing the statistics, product number, serial number, and firmware revision.

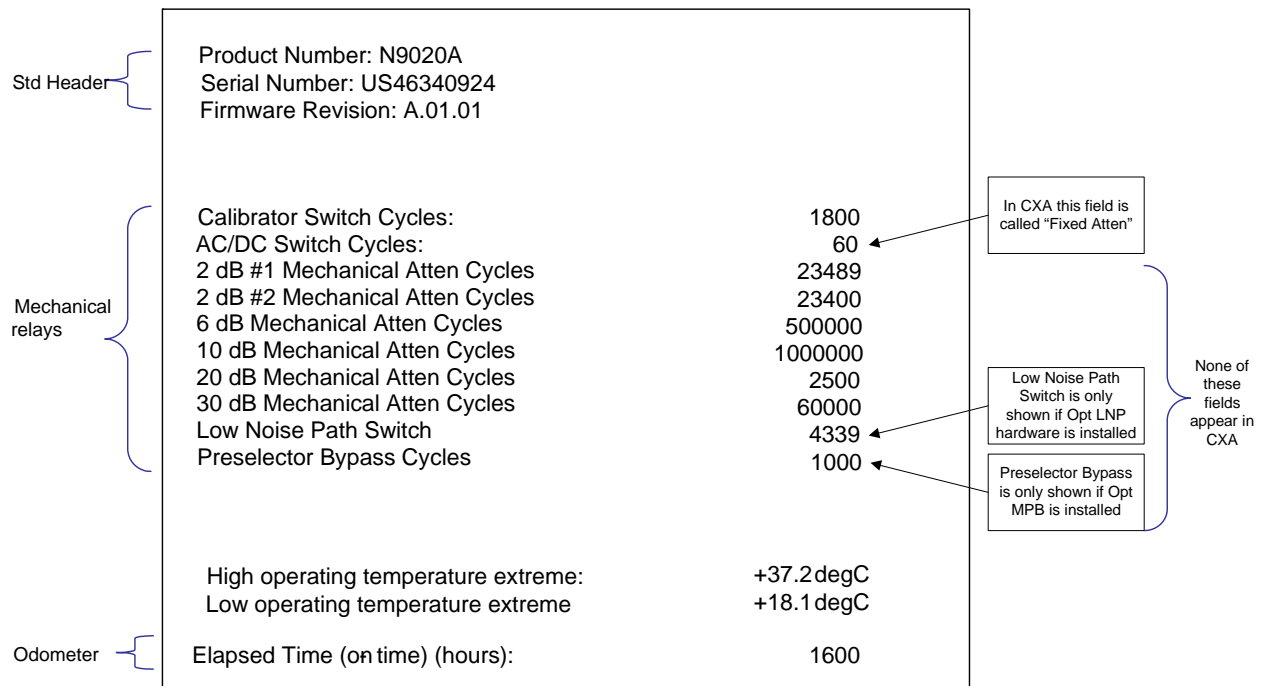

The data will be updated only when the Show Hardware Statistics menu key is pressed, it will not be updated while the screen is displayed.

The tabular data should be directly printable.

Key Path	System, Diagnostics
----------	----------------------------

Mode	All
Notes	The values displayed on the screen are only updated upon entry to the screen and not updated while the screen is being displayed.
Initial S/W Revision	Prior to A.02.00

SCPI for Show Hardware Statistics (Remote Commands Only)

Each of the hardware statistic items can be queried via SCPI.

- “Query the Mechanical Relay Cycle Count” on page 286
- “Query the Operating Temperature Extremes” on page 286
- “Query the Elapsed Time since 1st power on” on page 287

Query the Mechanical Relay Cycle Count

Returns the count of mechanical relay cycles.

Remote Command	:SYSTem:MRELay:COUNT?
Example	:SYST:MREL:COUN?
Notes	<p>Query Only</p> <p>The return value is a comma separated list of the individual counts for each mechanical relay.</p> <p>The position of the relays in the list is: “<Cal Signal>,<AC/DC>,<2dB #1 Atten>,<2dB #2 Atten>,<6dB Atten>,<10dB Atten>,<20dB Atten>,<30dB Atten>,<Fixed Atten>,<Low Noise Path Switch>,<Presel Bypass>”</p> <p>Items in the list not pertaining to your particular hardware configuration will return as -999 for those items.</p>
Initial S/W Revision	Prior to A.02.00
Modified at S/W Revision	A.03.00, A.04.00

Query the Operating Temperature Extremes

Returns the low operating temperature extreme value. The value survives a power-cycle and is the temperature extreme encountered since the value was reset by the factory or service center.

Mode	All
Remote Command	:SYSTem:TEMPerature:LEXTreme?
Example	:SYST:TEMP:LEXT?
Notes	Value is in degrees Celsius at which the lowest operating temperature has been recorded since 1st power-up.
State Saved	No

Initial S/W Revision	Prior to A.02.00
Mode	All
Remote Command	:SYSTem:TEMPerature:HEXTreme?
Example	:SYST:TEMP:HEXT?
Notes	Value is in degrees Celsius at which the highest operating temperature has been recorded since 1st power-up.
State Saved	No
Initial S/W Revision	Prior to A.02.00

Query the Elapsed Time since 1st power on

Returns the elapsed on-time in minutes since 1st power-on.

Remote Command	:SYSTem:PON:ETIMe?
Example	:SYST:PON:ETIM?
Notes	Query Only
Initial S/W Revision	Prior to A.02.00

Advanced

Accesses advanced diagnostic capabilities performed in the factory or under instructions from repair procedures. This menu key is only visible when the logged-in user is “saservice”. The first access to the Advanced Diagnostic Menu after invoking the instrument application will require an authentication, which is to enter the Service Code. Subsequent accesses to the Advanced Diagnostic Menu are unimpeded. The Authentication dialog looks like:

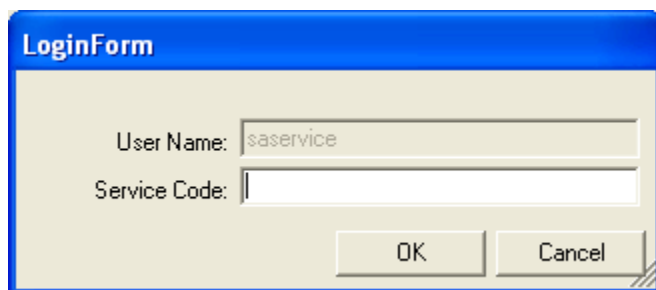

“OK” is the default key thus the Enter key is used to complete the entry. If invalid Service Code is entered authentication is not granted and you are provided the following dialog:

System Functions
System



Key Path	System, Diagnostics
Notes	Password is required to access this menu.
Initial S/W Revision	Prior to A.02.00

Service

Accesses capabilities performed in the factory or under instructions from repair procedures. This menu key is only visible when the logged-in user is “advanceduser” or “saservice”. The first access to the Service Menu after invoking the instrument application will require an authentication Service Code.

Key Path	System
Initial S/W Revision	Prior to A.02.00

System Remote Commands (Remote Commands Only)

The commands in this section have no front panel key equivalent

Initial S/W Revision	Prior to A.02.00
----------------------	------------------

List installed Options (Remote Command Only)

Lists the installed options that pertain to the instrument (signal analyzer). .

Mode	All
Remote Command	:SYSTem:OPTions?
Example	:SYST:OPT?
Notes	The return string is a comma separated list of the installed options. For example: “503,P03,PFR” :SYSTem:OPTions? and *OPT? are the same.
State Saved	No
Initial S/W Revision	Prior to A.02.00

Lock the Front-panel keys (Remote Command Only)

Disables the instrument keyboard to prevent local input when the instrument is controlled remotely. Annunciation showing a “K” for ‘Klock’ (keyboard lock) alerts the local user that the keyboard is locked. Klock is similar to the GPIB Local Lockout function; namely that no front-panel keys are active with the exception of the Power Standby key. (The instrument is allowed to be turned-off if Klock is ON.) The Klock command is used in remote control situations where Local Lockout cannot be used.

Although primary intent of Klock is to lock-out the front panel, it will lock-out externally connected keyboards through USB. Klock has no effect on externally connected pointing devices (mice).

The front panel ‘Local’ key (Cancel/Esc) has no effect if Klock is ON.

Mode	All
Remote Command	:SYSTem:KLOCK OFF ON 0 1 :SYSTem:KLOCK?
Example	:SYST:KLOC ON
Notes	Keyboard lock remains in effect until turned-off or the instrument is power-cycled
Preset	Initialized to OFF at startup, unaffected by Preset
State Saved	No
Initial S/W Revision	Prior to A.02.00

List SCPI Commands (Remote Command Only)

Outputs a list of the valid SCPI commands for the currently selected Mode.

Remote Command	:SYSTem:HELP:HEADers?
Example	:SYST:HELP:HEAD?
Notes	The output is an IEEE Block format with each command separated with the New-Line character (hex 0x0A)
Initial S/W Revision	Prior to A.02.00

SCPI Version Query (Remote Command Only)

Returns the SCPI version number with which the instrument complies. The SCPI industry standard changes regularly. This command indicates the version used when the instrument SCPI commands were defined.

Remote Command	:SYSTem:VERSion?
Example	:SYST:VERS?
Initial S/W Revision	Prior to A.02.00

Date (Remote Command Only)

The recommended access to the Date, Time, and Time zone of the instrument is through the Windows native control (Control Panel or accessing the Task Bar). You may also access this information remotely, as shown in this command and Time (below).

Sets or queries the date in the instrument.

Mode	All
Remote Command	:SYSTem:DATE "<year>, <month>, <day>" :SYSTem:DATE?
Example	:SYST:DATE "2006,05,26"
Notes	<year> is the four digit representation of year. (for example, 2006) <month> is the two digit representation of year. (for example. 01 to 12) <day> is the two digit representation of day. (for example, 01 to 28, 29, 30, or 31) depending on the month and year
Initial S/W Revision	Prior to A.02.00

Time (Remote Command Only)

Sets or queries the time in the instrument.

Mode	All
Remote Command	:SYSTem:TIME "<hour>, <minute>, <second>" :SYSTem:TIME?
Example	:SYST:TIME "13,05,26"
Notes	<hour> is the two digit representation of the hour in 24 hour format <minute> is the two digit representation of minute <second> is the two digit representation of second
Initial S/W Revision	Prior to A.02.00

User Preset

Accesses a menu that gives you the following three choices:

User Preset – recalls a state previously saved using the **Save User Preset** function.

User Preset All Modes – presets all of the modes in the analyzer

Save User Preset – saves the current state for the current mode

Key Path	Front-panel key
Initial S/W Revision	Prior to A.02.00

User Preset

User Preset sets the state of the currently active mode back to the state that was previously saved for this mode using the **Save User Preset** menu key or the SCPI command, `SYST:PRESet:USER:SAV`. It not only recalls the Mode Preset settings, but it also recalls all of the mode persistent settings, and the Input/Output system setting that existed at the time **Save User Preset** was executed.

If a **Save User Preset** has not been done at any time, **User Preset** recalls the default user preset file for the currently active mode. The default user preset files are created if, at power-on, a mode detects there is no user preset file. There will never be a scenario when there is no user preset file to restore. For each mode, the default user preset state is the same state that would be saved if a **Save User Preset** is performed in each mode right after doing a Restore Mode Default and after a Restore Input/Output Defaults.

The User Preset function does the following:

- Aborts the currently running measurement.
- Sets the mode State to the values defined by **Save User Preset**.
- Makes the saved measurement for the currently running mode the active measurement.
- Brings up the saved menu for the power-on mode.
- Clears the input and output buffers.
- Sets the Status Byte to 0.

Key Path	User Preset
Remote Command	:SYSTem:PRESet:USER
Example	:SYST:PRESet:USER:SAVE :SYST:PRESet:USER

Notes	<p>:SYST:PRES:USER:SAVE is used to save the current state as the user preset state.</p> <p>Clears all pending OPC bits. The Status Byte is set to 0.</p> <p>Pressing the User Preset front-panel key while already in the User Preset menu will cause the User Preset to get executed</p>
Couplings	<p>A user preset will cause the currently running measurement to be aborted and cause the saved measurement to be active. Recalling a User Preset file has the same issues that recalling a Save State file has. Some settings may need to be limited and therefore re-coupled, since the capabilities of the mode may have changes when the User Preset file was last saved.</p>
Initial S/W Revision	Prior to A.02.00

User Preset All Modes

Recalls all of the User Preset files for each mode, switches to the power-on mode, and activates the saved measurement from the power-on mode User Preset file.

NOTE When the instrument is secured, all of the user preset files are converted back to their default user preset files.

The User Preset function does the following:

- Aborts the currently running measurement.
- Switches the Mode to the power-on mode.
- Restores the User Preset files for each mode.
- Makes the saved measurement for the power-on mode the active measurement.
- Brings up the saved menu for the power-on mode.
- Clears the input and output buffers.
- Sets the Status Byte to 0.

Key Path	User Preset
Remote Command	:SYSTem:PRESet:USER:ALL
Example	:SYST:PRES:USER:SAVE :SYST:PRES:USER:ALL
Notes	<p>Clears all pending OPC bits. The Status Byte is set to 0.</p> <p>:SYST:PRES:USER:SAVE is used to save the current state as the user preset state.</p>

Couplings	A user preset will cause the currently running measurement to be aborted, cause a mode switch to the power-on mode, and cause the saved measurement to be active in the power-on mode. Recalling a User Preset file has the same issues that recalling a Save State file has. Some settings may need to be limited and therefore re-coupled, since the capabilities of the mode may have changes when the User Preset file was last saved.
Initial S/W Revision	Prior to A.02.00

Save User Preset

Saves the currently active mode and its State. You can recall this User Preset file by pressing the User Preset menu key or sending the SYST:PRES:USER remote command. This same state is also saved by the Save State function.

Key Path	User Preset
Remote Command	:SYSTem:PRESet:USER:SAVE
Example	:SYST:PRES:USER:SAVE
Notes	:SYST:PRES:SAVE creates the same file as if the user requested a *SAV or a MMEM:STOR:STAT, except User Preset Save does not allow the user to specify the filename or the location of the file.
Initial S/W Revision	Prior to A.02.00

System Functions
User Preset

The Channel Power measurement is used to find the total power present in a specified bandwidth. The power spectral density (the power in the signal normalized to 1 Hz) is also reported. For measurement results and views, see [“View/Display” on page 354](#).

This topic contains the following sections:

[“Measurement Commands for Channel Power” on page 295](#)

[“Remote CommandResults for Channel Power Measurement” on page 295](#)

Measurement Commands for Channel Power

These commands are used to measure the total rms power in a specified integration bandwidth.

Use :INSTrument:SElect to set the mode.

```
:CONFigure:CHPower
:CONFigure:CHPower:NDEFault
:INITiate:CHPower
:FETCh:CHPower [n] ?
:MEASure:CHPower [n] ?
:READ:CHPower [n] ?
:FETCh:CHPower:CHPower?
:MEASure:CHPower:CHPower?
:READ:CHPower:CHPower?
:FETCh:CHPower:DENSity?
:MEASure:CHPower:DENSity?
:READ:CHPower:DENSity
```

For more measurement related commands, see the SENSE subsystem, and the section [“Remote Measurement Functions” on page 1083](#).

Remote CommandResults for Channel Power Measurement

For DVB-T/H and DTMB (CTTB) mode, see [“DVB-T/H and DTMB \(CTTB\) Mode Remote Command Results” on page 296](#) Mode Remote Command Results.

For ISDB-T and CMMB mode, see [“ISDB-T and CMMB mode Remote Command Results” on](#)

Command	Return Value
FETCh:CHPower[n]? MEASure:CHPower[n]? READ:CHPower[n]?	Refer to the table below.
FETCh:CHPower:CHPower? MEASure:CHPower:CHPower? READ:CHPower:CHPower?	Returns the Channel Power (dBm) (BW compatibility functionality)
FETCh:CHPower:DENSity? MEASure:CHPower:DENSity? READ:CHPower:DENSity?	Returns the Power Spectral Density (dBm/Hz) (BW compatibility functionality)

n	Results Returned
n=1 (or not specified)	Returns scalar results: <ol style="list-style-type: none"> 1. Channel Power is a floating point number representing the total channel power in the specified integration bandwidth. 2. PSD (Power Spectral Density) is the power in the specified unit bandwidth. The unit bandwidth is selected by the PSD Unit parameter in either dBm/Hz or dBm/MHz.
2	Returns floating point numbers that are the captured trace data of the power (in dBm/resolution BW) of the signal. The frequency span of the captured trace data is specified by the Span key.

DVB-T/H and DTMB (CTTB) Mode Remote Command Results

The following commands are available only for DVB-T/H and DTMB (CTTB) mode.

Condition	n	Results Returned
	n=1 (or not specified)	Returns scalar results: <ol style="list-style-type: none"> 1. Channel Power is a floating point number representing the total channel power in the specified integration bandwidth. 2. PSD (Power Spectral Density) is the power in the specified unit bandwidth. The unit bandwidth is selected by the PSD Unit parameter in either dBm/Hz or dBm/MHz.
	2	Returns floating point numbers that are the captured trace data of the power (in dBm/resolution BW) of the signal. The frequency span of the captured trace data is specified by the Span key.

Condition	n	Results Returned
Mode = DVB-T/H or Mode = DTMB (CTTB)	3	Returns 7 comma-separated scalar results, in the following order. <ol style="list-style-type: none"> 1. The shoulder attenuation result (dB) 2. Lower shoulder attenuation result (dB) 3. Upper shoulder attenuation result (dB) 4. Lower Offset - MAX shoulder point power (dBm) 5. Lower Offset - MAX shoulder point frequency (MHz) 6. Upper Offset - MAX shoulder point power (dBm) 7. Upper Offset - MAX shoulder point frequency (MHz) <p>If the results are not available, -999.0 is returned.</p> <p>For example, if current view is RF spectrum or spectrum mask, -999.0 is returned.</p>
Mode = DVB-T/H or Mode = DTMB (CTTB)	4	Returns floating point numbers that are the captured trace data of the power (in dBm/resolution BW) of the signal in the left graph of the shoulder attenuation view. <p>If the results are not available, -999.0 is returned.</p> <p>For example, if current view is RF spectrum or spectrum mask, -999.0 is returned.</p>
Mode = DVB-T/H or Mode = DTMB (CTTB)	5	Returns floating point numbers that are the captured trace data of the power (in dBm/resolution BW) of the signal in the right graph of the shoulder attenuation view. <p>If the results are not available, -999.0 is returned.</p> <p>For example, if current view is RF spectrum or spectrum mask, -999.0 is returned.</p>
Mode = DVB-T/H or Mode = DTMB (CTTB)	6	Returns floating point numbers that are the captured trace data of the power (in dBm/resolution BW) of the mask in the spectrum mask view. <p>If the results are not available, -999.0 is returned.</p> <p>For example, if current view is RF spectrum or shoulder attenuation, -999.0 is returned.</p>

Condition	n	Results Returned
Mode = DVB-T/H or Mode = DTMB (CTTB)	7	<p>Returns the failed point information in the following order:</p> <ol style="list-style-type: none"> 1. the 1st failed point frequency (MHz) 2. the 1st failed point absolute power (dBm) 3. the 1st failed point relative power (dB) 4. the 2nd failed point frequency (MHz) 5. the 2nd failed point absolute power (dBm) 6. the 2nd failed point relative power (dB) ... 3*N-2. the (3*N-2)th failed point frequency (MHz) 3*N-1. the (3*N-1)th failed point absolute power (dBm) 3*N. the (3*N)th failed point relative power (dB) <p>If the number of failed points is less than 20, it will show all of them (frequency, power and relative power), N<20;</p> <p>If the number of failed points is great than 20, the first ten failed points and the last ten failed points will be show, N=20.</p> <p>If the results are not available, -999.0 is returned.</p> <p>For example, if current view is RF spectrum or shoulder attenuation, -999.0 is returned.</p>

ISDB-T and CMMB mode Remote Command Results

The following commands are available only for ISDB-T and CMMB mode.

Condition	n	Results Returned
	n=1 (or not specified)	<p>Returns scalar results:</p> <ol style="list-style-type: none"> 1. Channel Power is a floating point number representing the total channel power in the specified integration bandwidth. 2. PSD (Power Spectral Density) is the power in the specified unit bandwidth. The unit bandwidth is selected by the PSD Unit parameter in either dBm/Hz or dBm/MHz.
	2	Returns floating point numbers that are the captured trace data of the power (in dBm/resolution BW) of the signal. The frequency span of the captured trace data is specified by the Span key.

Condition	n	Results Returned
Mode = ISDB-T or Mode = CMMB	3	Returns 7 comma-separated scalar results, in the following order. 1. The shoulder attenuation result (dB) 2. Lower shoulder attenuation result (dB) 3. Upper shoulder attenuation result (dB) 4. Lower Offset - MAX shoulder point power (dBm) 5. Lower Offset - MAX shoulder point frequency (MHz) 6. Upper Offset - MAX shoulder point power (dBm) 7. Upper Offset - MAX shoulder point frequency (MHz) If the results are not available, -999.0 is returned. For example, if current view is RF spectrum or spectrum mask, -999.0 is returned.
Mode = ISDB-T or Mode = CMMB	4	Returns floating point numbers that are the captured trace data of the power (in dBm/resolution BW) of the signal in the left window of the shoulder attenuation view. If the results are not available, -999.0 is returned. For example, if current view is RF spectrum or spectrum mask, -999.0 is returned.
Mode = ISDB-T or Mode = CMMB	5	Returns floating point numbers that are the captured trace data of the power (in dBm/resolution BW) of the signal in the right window of the shoulder attenuation view. If the results are not available, -999.0 is returned. For example, if current view is RF spectrum or spectrum mask, -999.0 is returned.

Key Path	Meas
Mode	SA, WCDMA, C2K, WIMAX OFDMA, 1xEVDO, DVB-T/H, DTMB (CTTB), ISDB-T, CMMB, LTE, LTETDD
Initial S/W Revision	Prior to A.02.00
Modified at S/W Revision	A.03.00

AMPTD Y Scale

Accesses a menu of functions that enable you to set the vertical scale parameters. The parameter values are measurement independent, except all Attenuation values and the Internal Preamp selection, which are the same across all measurements.

Key Path	Front-panel key
Initial S/W Revision	Prior to A.02.00

Ref Value

Sets the value for the absolute power reference. However, since the Auto Scaling is defaulted to On, this value is automatically determined by the measurement result. When you set a value manually, Auto Scaling automatically changes to Off.

Key Path	AMPTD Y Scale
Mode	SA, WCDMA, C2K, WIMAX OFDMA, 1xEVDO, DVB-T/H, DTMB (CTTB), ISDB-T, CMMB, LTE, LTETDD
Remote Command	:DISPlay:CHPower:VIEW[1]:WINDow[1]:TRACe:Y[:SCALE]:RLEV el <real> :DISPlay:CHPower:VIEW[1]:WINDow[1]:TRACe:Y[:SCALE]:RLEV el?
Example	DISP:CHP:VIEW:WIND:TRAC:Y:RLEV 10 dBm DISP:CHP:VIEW:WIND:TRAC:Y:RLEV?
Notes	You must be in the Spectrum Analysis mode, W-CDMA mode, cdma2000 mode, DVB-T/H mode, DTMB (CTTB) mode, ISDB-T mode, CMMB mode, LTD mode, LTE TDD mode, 1xEVDO mode or WIMAX OFDMA mode to use this command. Use :INSTrument:SElect to set the mode.
Couplings	When the Auto Scaling is On, this value is automatically determined by the measurement result. When you set a value manually, Auto Scaling automatically changes to Off.
Preset	All except CDMA 1xEVDO: 10.00 dBm CDMA 1xEVDO: -10.00 dBm
State Saved	Saved in instrument state.
Min	-250.00 dBm
Max	250.00 dBm
Initial S/W Revision	Prior to A.02.00
Modified at S/W Revision	A.02.00, A.03.00

Attenuation

Accesses a menu of functions that enable you to change the attenuation settings. This key has read-back text that describes the total attenuator value.

See AMPTD Y Scale, “Attenuation” on page 910 in the “Common Measurement Functions” section for more information.

Key Path	AMPTD/Y Scale
Initial S/W Revision	Prior to A.02.00

Scale/Div

Sets the units per division of the vertical scale in the logarithmic display. However, since the Auto Scaling is defaulted to On, this value is automatically determined by the measurement result. When you set a value manually, Auto Scaling automatically changes to Off.

Key Path	AMPTD Y Scale
Mode	SA, WCDMA, C2K, WIMAX OFDMA, 1xEVDO, DVB-T/H, DTMB (CTTB), ISDB-T, CMMB, LTE, LTETDD
Remote Command	:DISPlay:CHPower:VIEW[1]:WINDow[1]:TRACe:Y[:SCALe]:PDIVision <rel_ampl> :DISPlay:CHPower:VIEW[1]:WINDow[1]:TRACe:Y[:SCALe]:PDIVision?
Example	DISP:CHP:VIEW:WIND:TRAC:Y:PDIV 2 DISP:CHP:VIEW:WIND:TRAC:Y:PDIV?
Notes	You must be in the Spectrum Analysis mode, W-CDMA mode, cdma2000 mode, DVB-T/H mode, DTMB (CTTB) mode, ISDB-T mode, CMMB mode, LTE mode, LTE TDD mode, 1xEVDO mode or WIMAX OFDMA mode to use this command. Use :INSTRument:SElect to set the mode.
Couplings	When the Auto Scaling is On, this value is automatically determined by the measurement result. When you set a value manually, Auto Scaling automatically changes to Off.
Preset	10.00 dB
State Saved	Saved in instrument state.
Min	0.10 dB
Max	20.00 dB
Initial S/W Revision	Prior to A.02.00
Modified at S/W Revision	A.02.00, A.03.00

Presel Center

When this key is pressed, the centering of the preselector filter is adjusted to optimize the amplitude accuracy at the frequency of the selected marker.

See [“Presel Center” on page 926](#) under AMPTD Y Scale in the "Common Measurement Functions" section for more information.

This is only available when the selected input is RF.

Key Path	AMPTD/Y Scale
Initial S/W Revision	Prior to A.02.00

Presel Adjust

Allows you to manually adjust the preselector filter frequency to optimize its response to the signal of interest. This function is only available when Presel Center is available.

See [“Preselector Adjust” on page 927](#) under AMPTD Y Scale in the "Common Measurement Functions" section for more information.

This is only available when the selected input is RF.

Key Path	AMPTD/Y Scale
Initial S/W Revision	Prior to A.02.00

Y Axis Unit

Allows you to change the vertical (Y) axis amplitude unit.

See [“Y Axis Unit” on page 929](#) under AMPTD Y Scale in the "Common Measurement Functions" section for more information.

Key Path	AMPTD/Y Scale
Initial S/W Revision	A.04.00

Reference Level Offset

Adds an offset value to the displayed reference level. The reference level is the absolute amplitude represented by the top graticule line on the display.

See [“Reference Level Offset” on page 934](#) under AMPTD Y Scale in the "Common Measurement Functions" section for more information.

Key Path	AMPTD/Y Scale
Initial S/W Revision	A.04.00

μW Path Control

The **μW Path Control** functions include the **μW Preselector Bypass** (Option MPB) and **Low Noise Path** (Option LNP) controls in the High Band path circuits.

See [“μW Path Control ” on page 935](#) under AMPTD Y Scale in the "Common Measurement Functions" section for more information.

Key Path	AMPTD/Y Scale
Initial S/W Revision	A.04.00

Internal Preamp

Accesses a menu of functions that enable you to control the internal preamplifiers.

See AMPTD Y Scale, [“Internal Preamp” on page 939](#) in the “Common Measurement Functions” section for more information.

Key Path	AMPTD/Y Scale
Initial S/W Revision	Prior to A.02.00

Ref Position

Positions the reference level at the top, center, or bottom of the Y Scale display. Changing the reference position does not change the reference level value.

Key Path	AMPTD Y Scale
Mode	SA, WCDMA, C2K, WIMAX OFDMA, 1xEVDO, DVB-T/H, DTMB (CTTB), ISDB-T, CMMB, LTE, LTE/TDD
Remote Command	:DISPlay:CHPower:VIEW[1]:WINDow[1]:TRACe:Y[:SCALe]:RPOS ition TOP CENTer BOTTom :DISPlay:CHPower:VIEW[1]:WINDow[1]:TRACe:Y[:SCALe]:RPOS ition?
Example	DISP:CHP:VIEW:WIND:TRAC:Y:RPOS CENT DISP:CHP:VIEW:WIND:TRAC:Y:RPOS?
Notes	You must be in the Spectrum Analysis mode, W-CDMA mode, cdma2000 mode, DVB-T/H mode, DTMB (CTTB) mode, ISDB-T mode, CMMB mode, LTE mode, LTE TDD mode, 1xEVDO mode or WIMAX OFDMA mode to use this command. Use :INSTrument:SElect to set the mode.
Preset	TOP
State Saved	Saved in instrument state.
Range	Top Ctr Bot
Initial S/W Revision	Prior to A.02.00

Channel Power Measurement
AMPTD Y Scale

Modified at S/W Revision	A.02.00, A.03.00
--------------------------	------------------

Auto Scaling

Toggles the Auto Scaling function between On and Off.

Key Path	AMPTD Y Scale
Mode	SA, WCDMA, C2K, WIMAX OFDMA, 1xEVDO, DVB-T/H, DTMB (CTTB), ISDB-T, CMMB, LTE, LTETDD
Remote Command	:DISPlay:CHPower:VIEW[1]:WINDow[1]:TRACe:Y[:SCALe]:COUPle 0 1 OFF ON :DISPlay:CHPower:VIEW[1]:WINDow[1]:TRACe:Y[:SCALe]:COUPle?
Example	DISP:CHP:VIEW:WIND:TRAC:Y:COUP OFF DISP:CHP:VIEW:WIND:TRAC:Y:COUP?
Couplings	When Auto Scaling is On, and the Restart front-panel key is pressed, this function automatically sets the scale per division to 10 dB and determines the reference values based on the measurement results. When you set a value to either Scale/Div or Ref Value manually, Auto Scaling automatically changes to Off.
Preset	1
State Saved	Saved in instrument state.
Range	On Off
Initial S/W Revision	Prior to A.02.00
Modified at S/W Revision	A.02.00, A.03.00

Auto Couple

See [“Auto Couple” on page 943](#) in the "Common Measurement Functions" section for more information.

BW

Accesses a menu of functions that enable you to specify and control the video and resolution bandwidths. You can also select the type of filter for the measurement and set the filter bandwidth.

Key Path	Front-panel key
Initial S/W Revision	Prior to A.02.00

Res BW

Sets the value of the resolution bandwidth (RBW). If an unavailable bandwidth is entered with the numeric keypad, the closest available bandwidth is selected.

Key Path	BW
Mode	SA, WCDMA, C2K, WIMAX OFDMA, 1xEVDO, DVB-T/H, DTMB (CTTB), ISDB-T, CMMB, LTE, LTETDD
Remote Command	[:SENSe]:CHPower:BANDwidth[:RESolution] <bandwidth> [:SENSe]:CHPower:BANDwidth[:RESolution]? [:SENSe]:CHPower:BANDwidth[:RESolution]:AUTO ON OFF 1 0 [:SENSe]:CHPower:BANDwidth[:RESolution]:AUTO?
Example	CHP:BAND 5 MHz CHP:BAND? CHP:BAND:AUTO ON CHP:BAND:AUTO?
Notes	You must be in the Spectrum Analysis mode, W-CDMA mode, cdma2000 mode, DVB-T/H mode, DTMB (CTTB) mode, ISDB-T mode, CMMB mode, LTE mode, LTE TDD mode, 1xEVDO mode or WIMAX OFDMA mode to use this command. Use :INSTrument:SElect to set the mode.
Couplings	Sweep time is coupled to the RBW. As the RBW changes, the sweep time (if set to Auto) is changed to maintain amplitude calibration. Video bandwidth (VBW) is coupled to the RBW. As the resolution bandwidth changes, the video bandwidth (if set to Auto) changes to maintain the ratio of VBW/RBW (10:1). When the Res BW is set to Auto, the resolution bandwidth is auto-coupled to the span. The ratio of Span/RBW is approximately 106:1 when auto coupled. When Res BW is set to Man, and the bandwidths are entered manually, these bandwidths are used regardless of other analyzer settings.

Preset	SA: Auto WCDMA: 240 kHz C2K: 24 kHz WIMAX OFDMA: 100kHz 1xEVDO: 30kHz DVB-T/H: 3.9kHz DTMB (CTTB): 3.9kHz ISDB-T: 30kHz CMMB: 3.9kHz LTE: Auto LTETDD: Auto WCDMA, C2K, 1xEVDO , WIMAX OFDMA, DVB-T/H, DTMB (CTTB), ISDB-T, CMMB:: OFF SA, LTE, LTETDD: ON
State Saved	Saved in instrument state.
Min	1 Hz
Max	8 MHz
Backwards Compatibility SCPI	[[:SENSe]:CHPower:BWIDth[:RESolution]
Initial S/W Revision	Prior to A.02.00
Modified at S/W Revision	A.02.00, A.03.00

Video BW

Changes the analyzer post-detection filter (VBW).

Key Path	BW
Mode	SA, WCDMA, C2K, WIMAX OFDMA, 1xEVDO, DVB-T/H, DTMB (CTTB), ISDB-T, CMMB, LTE, LTETDD
Remote Command	[[:SENSe]:CHPower:BA ^N Dwidth:VIDeo <bandwidth> [:SENSe]:CHPower:BA ^N Dwidth:VIDeo? [:SENSe]:CHPower:BA ^N Dwidth:VIDeo:AUTO ON OFF 1 0 [:SENSe]:CHPower:BA ^N Dwidth:VIDeo:AUTO?
Example	CHP:BA ^N D:VID 2.4 MHz CHP:BA ^N D:VID? CHP:BA ^N D:VID:AUTO OFF CHP:BA ^N D:VID:AUTO?

Channel Power Measurement
BW

Notes	You must be in the Spectrum Analysis mode, W-CDMA mode, cdma2000 mode, DVB-T/H mode, DTMB (CTTB) mode, ISDB-T mode, CMMB mode, LTE mode, LTE TDD mode, 1xEVDO mode or WIMAX OFDMA mode to use this command. Use :INSTrument:SElect to set the mode.
Dependencies	See Couplings
Couplings	<p>Video bandwidth (VBW) is coupled to the RBW. As the resolution bandwidth changes, the video bandwidth (if set to Auto) changes to maintain the ratio set by VBW/RBW.</p> <p>Sweep Time is coupled to the Video Bandwidth (VBW). As the VBW is changed, the sweep time (when set to Auto) is changed to maintain amplitude calibration. This occurs because of common hardware between the two circuits, even though the Video BW filter is not actually “in-circuit” when the detector is set to Average. Because the purpose of the average detector and the VBW filter are the same, either can be used to reduce the variance of the result.</p> <p>Although the VBW filter is not “in-circuit” when using the average detector, the Video BW key can have an effect on (Auto) sweep time, and is not disabled. In this case, reducing the VBW setting increases the sweep time, which increases the averaging time, producing a lower-variance trace.</p> <p>When using the average detector with either Sweep Time set to Man, or in zero span, the VBW setting has no effect and is disabled (grayed out).</p> <p>When the video bandwidth is AUTO coupled, the video bandwidth value is set to: Resolution Bandwidth * Video Bandwidth to Resolution Bandwidth Ratio</p>
Preset	SA: Auto WCDMA: 2.4MHz C2K: 240 kHz WIMAX OFDMA: Auto 1xEVDO: 300 kHz DVB-T/H: 39kHz DTMB (CTTB): 39kHz ISDB-T: 300kHz CMMB: 39kHz LTE: Auto LTETDD: Auto ON
State Saved	Saved in instrument state.
Min	1 Hz
Max	50 MHz
Initial S/W Revision	Prior to A.02.00

Modified at S/W Revision	A.02.00, A.03.00
--------------------------	------------------

Filter Type

Selects the type of bandwidth filter that is used. The choices are Gaussian or Flat top.

Key Path	BW
Mode	SA, WCDMA, C2K, WIMAX OFDMA, 1xEVDO, DVB-T/H, DTMB (CTTB), ISDB-T, CMMB, LTE, LTE-TDD
Remote Command	[:SENSE] :CHPower:Bandwidth:SHAPE GAUSSian FLATtop [:SENSE] :CHPower:Bandwidth:SHAPE?
Example	CHP:BAND:SHAP GAUS CHP:BAND:SHAP?
Preset	GAUSSian
State Saved	Saved in instrument state.
Range	Gaussian Flattop
Backwards Compatibility SCPI	[:SENSE] :CHPower:BWIDth:SHAPE
Initial S/W Revision	Prior to A.02.00
Modified at S/W Revision	A.02.00, A.03.00

Cont

See “[Cont \(Continuous Measurement/Sweep\)](#)” on page 957 in the "Common Measurement Functions" section for more information.

FREQ Channel

See “[FREQ Channel](#)” on page 959 in the "Common Measurement Functions" fsection or more information.

Input/Output

See “[Input/Output](#)” on page 969 in the "Common Measurement Functions" section for more information.

Marker

Accesses a menu that enables you to select, set up and control the markers for the current measurement.

Key Path	Front-panel key
Initial S/W Revision	Prior to A.02.00

Select Marker

Displays 12 markers available for selection.

Key Path	Marker
Initial S/W Revision	Prior to A.02.00

Marker Type

Sets the marker control mode to **Normal**, **Delta**, **Fixed** or **Off**. All interactions and dependencies detailed under the key description are enforced when the remote command is sent. If the selected marker is Off, pressing Marker sets it to Normal and places it at the center of the screen on the trace determined by the **Marker Trace** rules. At the same time, **Marker X Axis Value** appears on the Active Function area.

The default active function is the active function for the currently selected marker control mode. If the current control mode is Off, there is no active function and the active function is turned off.

Key Path	Marker
Mode	SA, WCDMA, C2K, WIMAX OFDMA, 1xEVDO, DVB-T/H, DTMB (CTTB), ISDB-T, CMMB, LTE, LTETDD
Remote Command	:CALCulate:CHPower:MARKer[1] 2 3 4 5 6 7 8 9 10 11 12:MODE POSITION DELTA OFF :CALCulate:CHPower:MARKer[1] 2 3 4 5 6 7 8 9 10 11 12:MODE?
Example	CALC:CHP:MARK3:MODE POS CALC:CHP:MARK3:MODE?
Notes	If the selected marker is Off, pressing Marker sets it to Normal and places it at the center of the screen on the trace determined by the Marker Trace rules. At the same time, Marker X Axis Value appears on the Active Function area. Default Active Function: the active function for the selected marker's current control mode. If the current control mode is Off, there is no active function and the active function is turned off. Active Function Display: the marker X axis value entered in the active function area displays the marker value to its full entered precision.
Preset	OFF

State Saved	Saved in instrument state.
Range	Normal Delta Off
Initial S/W Revision	Prior to A.02.00
Modified at S/W Revision	A.02.00, A.03.00

Marker X Axis Value (Remote Command Only)

Sets the marker X Axis value in the current marker X Axis Scale unit. It has no effect if the control mode is **Off**, but is the SCPI equivalent of entering an X value if the control mode is **Normal**, **Delta**, or **Fixed**.

Mode	SA, WCDMA, C2K, WIMAX OFDMA, 1xEVDO, DVB-T/H, DTMB (CTTB), ISDB-T, CMMB, LTE, LTETDD
Remote Command	:CALCulate:CHPower:MARKer [1] 2 3 4 5 6 7 8 9 10 11 12 :X <real> :CALCulate:CHPower:MARKer [1] 2 3 4 5 6 7 8 9 10 11 12 :X ?
Example	CALC:CHP:MARK3:X 0 CALC:CHP:MARK3:X?
Notes	The query returns the marker's absolute X Axis value if the control mode is Normal , or the offset from the marker's reference marker if the control mode is Delta . The query is returned in the fundamental units for the current marker X Axis scale: Hz for Frequency .
Preset	After a preset, all markers are turned OFF, so Marker X Axis Value query returns a not a number (NAN).
State Saved	Saved in instrument state.
Min	-9.9E+37
Max	9.9E+37
Initial S/W Revision	Prior to A.02.00
Modified at S/W Revision	A.02.00, A.03.00

Marker X Axis Position (Remote Command Only)

Sets the marker X Axis Scale position in trace points. This setting has no effect if the control mode is **Off**, but is the SCPI equivalent of entering a value if the control mode is **Normal** or **Delta**. The entered value is immediately translated into the current X Axis Scale units for setting the value of the marker.

Mode	SA, WCDMA, C2K, WIMAX OFDMA, 1xEVDO, DVB-T/H, DTMB (CTTB), ISDB-T, CMMB, LTE, LTETDD
------	--

Remote Command	:CALCulate:CHPower:MARKer [1] 2 3 4 5 6 7 8 9 10 11 12 :X :POSition <real> :CALCulate:CHPower:MARKer [1] 2 3 4 5 6 7 8 9 10 11 12 :X :POSition?
Example	CALC:CHP:MARK10:X:POS 0 CALC:CHP:MARK10:X:POS?
Notes	The query returns the marker's absolute X Axis value in trace points if the control mode is Normal , or the offset from the marker's reference marker in trace points if the control mode is Delta .
Preset	After a preset, all markers are turned OFF, so Marker X Axis Value query returns a not a number (NaN).
State Saved	Saved in instrument state.
Min	-9.9E+37
Max	9.9E+37
Initial S/W Revision	Prior to A.02.00
Modified at S/W Revision	A.02.00, A.03.00

Marker Y Axis Value (Remote Command only)

Returns the marker Y Axis value in the current marker Y Axis unit.

Mode	SA, WCDMA, C2K, WIMAX OFDMA, 1xEVDO, DVB-T/H, DTMB (CTTB), ISDB-T, CMMB, LTE, LTETDD
Remote Command	:CALCulate:CHPower:MARKer [1] 2 3 4 5 6 7 8 9 10 11 12 :Y ?
Example	CALC:CHP:MARK11:Y?
Preset	Result dependent on Markers setup and signal source.
State Saved	Saved in instrument state.
Initial S/W Revision	Prior to A.02.00
Modified at S/W Revision	A.02.00, A.03.00

Properties

Accesses the marker properties menu.

Key Path	Marker
Initial S/W Revision	Prior to A.02.00

Select Marker

Displays 12 markers available for selection.

Key Path	Marker
Initial S/W Revision	Prior to A.02.00

Relative To

Sets the reference marker that the selected marker will be relative to.

Key Path	Marker, Properties
Mode	SA, WCDMA, C2K, WIMAX OFDMA, 1xEVDO, DVB-T/H, DTMB (CTTB), ISDB-T, CMMB, LTE, LTETDD
Remote Command	:CALCulate:CHPower:MARKer [1] 2 3 4 5 6 7 8 9 10 11 12 :R EFerence <integer> :CALCulate:CHPower:MARKer [1] 2 3 4 5 6 7 8 9 10 11 12 :R EFerence?
Example	CALC:CHP:MARK:REF 5 CALC:CHP:MARK:REF?
Notes	A marker cannot be relative to itself so that choice is grayed out, and if sent from SCPI generates error -221: "Settings conflict; marker cannot be relative to itself." When queried, a single value is returned (the specified marker numbers relative marker). You must be in the Spectrum Analysis or WCDMA mode to use this command. Use :INSTrument:SElect to set the mode.
Preset	2 3 4 5 6 7 8 9 10 11 12 1
State Saved	Saved in instrument state.
Min	1
Max	12
Initial S/W Revision	Prior to A.02.00
Modified at S/W Revision	A.02.00, A.03.00

Marker Trace (DVB-T/H and DTMB (CTTB) only)

Accesses a menu that allows you to assign a specified marker to the designated trace. This function is only valid for DVB-T/H and DTMB (CTTB) mode.

Key Path	Marker, Properties
Mode	DVB-T/H, DTMB (CTTB)

Remote Command	:CALCulate:CHPower:MARKer [1] 2 3 4 5 6 7 8 9 10 11 12 :T RACe RFSPectrum LSHoulder RSHoulder MASK :CALCulate:CHPower:MARKer [1] 2 3 4 5 6 7 8 9 10 11 12 :T RACe?
Example	CALC:CHP:MARK:TRAC RFSP CALC:CHP:MARK:TRAC?
Preset	RFSPectrum
State Saved	Saved in instrument state.
Range	RF Spectrum Left Shoulder Right Shoulder Spectrum Mask
Initial S/W Revision	A.02.00

Marker Trace (ISDB-T and CMMB only)

Accesses a menu that allows you to assign a specified marker to the designated trace. This function is only valid for ISDB-T and CMMB mode.

Key Path	Marker, Properties
Mode	ISDB-T, CMMB
Remote Command	:CALCulate:CHPower:MARKer [1] 2 3 4 5 6 7 8 9 10 11 12 :T RACe RFSPectrum LSHoulder RSHoulder :CALCulate:CHPower:MARKer [1] 2 3 4 5 6 7 8 9 10 11 12 :T RACe?
Example	CALC:CHP:MARK:TRAC RFSP CALC:CHP:MARK:TRAC?
Preset	RFSPectrum
State Saved	Saved in instrument state.
Range	RF Spectrum Left Shoulder Right Shoulder
Initial S/W Revision	A.02.00
Modified at S/W Revision	A.03.00

Couple Markers

When this function is active, moving any marker causes an “equal X Axis movement” of every other marker that is not set to **Off**. By “equal X Axis movement” we mean that we preserve the difference between each marker’s X Axis value (in the fundamental x-axis units of the trace that marker is on) and the X Axis value of the marker being moved (in the same fundamental x-axis units).

This may result in markers going off screen.

Key Path	Marker
-----------------	---------------

Channel Power Measurement
Marker

Mode	SA, WCDMA, C2K, WIMAX OFDMA, 1xEVDO, DVB-T/H, DTMB (CTTB), ISDB-T, CMMB, LTE, LTETDD
Remote Command	:CALCulate:CHPower:MARKer:COUple[:STATe] ON OFF 1 0 :CALCulate:CHPower:MARKer:COUple[:STATe]?
Example	CALC:CHPower:MARK:COUP ON
Preset	OFF
State Saved	Saved in instrument state.
Range	On Off
Initial S/W Revision	A.02.00

All Markers Off

Turns off all markers.

Key Path	Marker
Mode	SA, WCDMA, C2K, WIMAX OFDMA, 1xEVDO, DVB-T/H, DTMB (CTTB), ISDB-T, CMMB, LTE, LTETDD
Remote Command	:CALCulate:CHPower:MARKer:AOFF
Example	CALC:CHP:MARK:AOFF
Initial S/W Revision	Prior to A.02.00
Modified at S/W Revision	A.02.00, A.03.00

Backward Compatibility SCPI Commands

Sets or queries the state of a marker. Setting a marker which is OFF to state ON or 1 puts it in Normal mode and places it at the center of the screen.

Mode	SA, WCDMA, C2K, WIMAX OFDMA, 1xEVDO, DVB-T/H, DTMB (CTTB), ISDB-T, CMMB, LTE, LTETDD
Remote Command	:CALCulate:CHPower:MARKer[1] 2 3 4 5 6 7 8 9 10 11 12:STATe OFF ON 0 1 :CALCulate:CHPower:MARKer[1] 2 3 4 5 6 7 8 9 10 11 12:STATe?
Example	CALC:CHP:MARK3:STAT ON CALC:CHP:MARK3:STAT?
Preset	OFF
State Saved	Saved in instrument state.
Range	On Off

Initial S/W Revision	Prior to A.02.00
Modified at S/W Revision	A.02.00, A.03.00

Marker Function

There are no 'Marker Functions' supported in Channel Power, so this front-panel key displays a blank menu when pressed.

Key Path	Front-panel key
Initial S/W Revision	Prior to A.02.00

Marker To

There is no 'Marker To' functionality supported in Channel Power measurement, so this front-panel key displays a blank key menu when pressed.

Key Path	Front-panel key
Initial S/W Revision	Prior to A.02.00

Meas

See “[Meas](#)” on page 1083 in the "Common Measurement Functions" section for more information.

Meas Setup

Displays the setup menu for the currently selected measurement. The parameters included in the measurement setup include the following:

- Averaging
- IF Gain
- Channel Power Span
- Integrated Bandwidth
- Filter Bandwidth
- Root Raised Cosine (RRC) Filter

Key Path	Front-panel key
Initial S/W Revision	Prior to A.02.00

Avg/Hold Num

Specifies the number of measurement averages used to calculate the measurement result. The average is displayed at the end of each sweep. After the specified number of average counts, the averaging mode (terminal control) setting determines the averaging action.

Key Path	Meas Setup
Mode	SA, WCDMA, C2K, WIMAX OFDMA, 1xEVDO, DVB-T/H, DTMB (CTTB), ISDB-T, CMMB, LTE, LTE/TDD
Remote Command	[:SENSE] :CHPower:AVERage:COUNT <integer> [:SENSE] :CHPower:AVERage:COUNT? [:SENSE] :CHPower:AVERage[:STATE] ON OFF 1 0 [:SENSE] :CHPower:AVERage[:STATE] ?
Example	CHP:AVER:COUN 15 CHP:AVER:COUN? CHP:AVER ON CHP:AVER?
Notes	You must be in the Spectrum Analysis mode, W-CDMA mode, cdma2000 mode, DVB-T/H mode, DTMB (CTTB) mode, ISDB-T mode, CMMB mode, LTE mode, LTE TDD mode 1xEVDO mode or WIMAX OFDMA mode to use this command. Use :INSTRument:SELEct to set the mode.

Channel Power Measurement
Meas Setup

Preset	SA: 10 WCDMA: 200 WIMAX OFDMA, LTE, LTETDD: 200 CDMA2K: 20 1xEVDO: 20 DVB-T/H: 20 DTMB (CTTB): 20 ISDB-T: 10 CMMB: 10 ON
State Saved	Saved in instrument state.
Min	1
Max	10000
Initial S/W Revision	Prior to A.02.00
Modified at S/W Revision	A.02.00, A.03.00

Avg Mode

Allows you to select the type of termination control used for the averaging function. This determines the averaging action after the specified number of data acquisitions (average count) is reached.

When set to Exponential (Exp) the measurement averaging continues using the specified number of averages to compute each exponentially-weighted averaged value. The average is displayed at the end of each sweep.

When set to Repeat, the measurement resets the average counter each time the specified number of averages is reached.

Key Path	Meas Setup
Mode	SA, WCDMA, C2K, WIMAX OFDMA, 1xEVDO, DVB-T/H, DTMB (CTTB), ISDB-T, CMMB, LTE, LTETDD
Remote Command	[:SENSe] :CHPower:AVERage:TCONtrol EXPonential REPEAT [:SENSe] :CHPower:AVERage:TCONtrol?
Example	CHP:AVER:TCON EXP CHP:AVER:TCON?
Notes	You must be in the Spectrum Analysis mode, W-CDMA mode, cdma2000 mode, DVB-T/H mode, DTMB (CTTB) mode, ISDB-T mode, CMMB mode, LTE mode, LTE TDD mode, 1xEVDO mode or WIMAX OFDMA mode to use this command. Use :INSTrument:SElect to set the mode.
Preset	EXP

State Saved	Saved in instrument state.
Range	Exp Repeat
Initial S/W Revision	Prior to A.02.00
Modified at S/W Revision	A.02.00, A.03.00

Integ BW

Specifies the range of integration used in calculating the power in the channel. The integration bandwidth (IBW) is displayed on the trace as two markers connected by an arrow.

Key Path	Meas Setup
Mode	SA, WCDMA, C2K, WIMAX OFDMA, 1xEVDO, DVB-T/H, DTMB (CTTB), ISDB-T, CMMB, LTE, LTETDD
Remote Command	[:SENSe] :CHPower: BANDwidth: INTEgration <bandwidth> [:SENSe] :CHPower: BANDwidth: INTEgration?
Example	CHP: BAND: INT 10MHz CHP: BAND: INT?
Notes	You must be in the Spectrum Analysis mode, W-CDMA mode, cdma2000 mode, DVB-T/H mode, DTMB (CTTB) mode, ISDB-T mode, CMMB mode, LTE mode, LTE TDD mode, 1xEVDO mode or WIMAX OFDMA mode to use this command. Use :INSTrument: SELect to set the mode.
Couplings	The minimum value of the span is coupled with the integration bandwidth.
Preset	SA: 2 MHz WCDMA: 5 MHz C2K: 1.23 MHz WIMAX OFDMA: 10 MHz 1xEVDO: 1.23 MHz DVB-T/H: 7.61MHz DTMB (CTTB): 8MHz ISDB-T: 5.6MHz CMMB: 8MHz LTE: 5 MHz LTETDD: 5 MHz
State Saved	Saved in instrument state.
Min	100 Hz
Max	1 GHz
Max	RF Input: 1 GHz

Channel Power Measurement
Meas Setup

Initial S/W Revision	Prior to A.02.00
Modified at S/W Revision	A.02.00, A.03.00

PhNoise Opt

Selects the LO (local oscillator) phase noise behaviour for various operating conditions.

Key Path	Meas Setup
Initial S/W Revision	A.04.20

PhNoise Opt Auto

Selects the LO (local oscillator) phase noise behavior to optimize dynamic range and speed for various instrument operating conditions.

The X-Series has two grades of LO; a high performance LO that gives the best phase noise performance; and a medium-performance LO that gives excellent performance.

In models with the high performance LO, Auto will choose:

Fast Tuning whenever Span > 44.44 MHz or RBW > 1.9 MHz

otherwise, if center frequency is < 195 kHz OR ALL of the following are true:

CF 1 MHz AND Span 1.3 MHz AND RBW 75 kHz

then Best Close in Phase Noise;

otherwise, Best Wide-offset Phase Noise

In models with the medium-performance LO, Auto will choose:

Fast Tuning whenever Span > 12.34 MHz or RBW > 250 kHz

otherwise, if center frequency is < 25 kHz OR ALL of the following are true:

CF >= 1 MHz AND Span <= 141.4 kHz AND RBW <= 5 kHz

then **Best Close in Phase Noise**;

otherwise, **Best Wide-offset Phase Noise**

In units whose hardware does not provide for an extra-fast tuning option, the settings for Fast Tuning are the same as Best Close-in, so in those models you will see no difference between these settings.

These rules apply whether in swept spans, zero span, or FFT spans.

Key Path	Meas Setup
Remote Command	[:SENSe] :CHPower:FREQuency:SYNThesis:AUTO [:STATe] OFF ON 0 1 [:SENSe] :CHPower:FREQuency:SYNThesis:AUTO [:STATe] ?

Example	CHP:FREQ:SYNT:AUTO 1 CHP:FREQ:SYNT:AUTO?
Preset	OFF
State Saved	Saved in instrument state.
Range	Auto Man
Readback Text	“Auto” is underlined when Auto is selected, otherwise Man is underlined.
Initial S/W Revision	A.04.20

PhNoise Opt State

Selects the LO (local oscillator) phase noise behavior for various operating conditions.

Key Path	Meas Setup
Remote Command	[:SENSe] :CHPower:FREQuency:SYNTHeSis [:STATE] 1 2 3 [:SENSe] :CHPower:FREQuency:SYNTHeSis [:STATE] ?
Example	CHP:FREQ:SYNT 1 CHP:FREQ:SYNT?
Notes	Parameter key: <ol style="list-style-type: none"> 1. optimizes phase noise for close-in from the carrier. 2. optimizes phase noise for wide-offset from the carrier. 3. optimizes LO for tuning speed.
Preset	3
State Saved	Saved in instrument state.
Range	Hardware Dependent: PXA: Best Close-in Noise [offset < 140 kHz] Best Wide-offset Noise [offset > 160 kHz] Fast Tuning MXA, CXA: Best Close-in Noise [offset < 20 kHz] Best Wide-offset Noise [offset > 30 kHz] Fast Tuning
Readback Text	Close-in Wide-offset Fast Tuning, also the Man must be underlined.
Initial S/W Revision	A.04.20

IF Gain

Sets the IF Gain function to Auto, Low Gain or High Gain. These settings affect sensitivity and IF overloads.

Key Path	Meas Setup
----------	------------

Channel Power Measurement
Meas Setup

Initial S/W Revision	Prior to A.02.00
----------------------	------------------

IF Gain Auto

Activates the auto rules for IF Gain. When Auto is active, the IF Gain is set to High Gain under any of the following conditions:

- The input attenuator is set to 0 dB
- The preamp is turned On and the frequency range is under 3.6 GHz

For other settings, Auto sets the IF Gain to Low Gain.

Key Path	Meas Setup, IF Gain
Remote Command	[:SENSe] :CHPower:IF:GAIN:AUTO [:STATe] ON OFF 1 0 [:SENSe] :CHPower:IF:GAIN:AUTO [:STATe] ?
Example	CHP:IF:GAIN:AUTO ON CHP:IF:GAIN:AUTO?
Couplings	When the auto attenuation exists (for example, with an electrical attenuator), the IF Gain setting is changed using the following rule. Auto sets IF Gain to High Gain under any of the following conditions: the input attenuator is set to 0 dB, or the preamp is turned on and the frequency range is under 3.6 GHz. For other settings, Auto sets IF Gain to Low Gain.
Preset	OFF
State Saved	Saved in instrument state.
Range	Off On
Initial S/W Revision	Prior to A.02.00

IF Gain State

Selects the range of the IF Gain.

Key Path	Meas Setup, IF Gain
Remote Command	[:SENSe] :CHPower:IF:GAIN [:STATe] ON OFF 1 0 [:SENSe] :CHPower:IF:GAIN [:STATe] ?
Example	CHP:IF:GAIN ON CHP:IF:GAIN?
Notes	ON = high gain OFF = low gain

Couplings	When the auto attenuation exists (for example, with an electrical attenuator), the IF Gain setting is changed as following rule. Auto sets IF Gain to High Gain under any of the following conditions: the input attenuator is set to 0 dB, or the preamp is turned on and the frequency range is under 3.6 GHz. For other settings, Auto sets IF Gain to Low Gain.
Preset	OFF
State Saved	Saved in instrument state.
Range	Low Gain High Gain
Initial S/W Revision	Prior to A.02.00

RRC Filter

Turns the Root Raised Cosine (RRC) filter On or Off. The α value (roll off) for the filter is set to the value of the Filter Alpha parameter, and the RRC filter bandwidth is set to the Filter BW parameter.

Key Path	Meas Setup
Mode	SA, WCDMA, DVB-T/H, DTMB (CTTB), ISDB-T, CMMB, LTE, LTETDD
Remote Command	[:SENSe] :CHPower:FILTer [:RRC] [:STATe] OFF ON 0 1 [:SENSe] :CHPower:FILTer [:RRC] [:STATe] ?
Example	CHP:FILT OFF CHP:FILT?
Notes	This parameter is normally used when TETRA is selected as the Radio Std. You must be in the Spectrum Analysis mode, DVB-T/H mode, DTMB (CTTB) mode, ISDB-T mode, CMMB mode, LTE mode, LTE TDD mode, or W-CDMA mode to use this command. Use :INSTrument:SELEct to set the mode.
Dependencies	For CDMA2K mode, this key is blank. For 1xEVDO mode, this key is blank.
Preset	OFF
State Saved	Saved in instrument state.
Range	On Off
Initial S/W Revision	Prior to A.02.00
Modified at S/W Revision	A.02.00, A.03.00

Filter BW

Inputs the Root Raised Cosine (RRC) filter bandwidth. Normally, the filter bandwidth is the same as the

Channel Power Measurement Meas Setup

symbol rate of the signal.

Key Path	Meas Setup
Mode	SA, WCDMA, WIMAX OFDMA, DVB-T/H, DTMB (CTTB), LTE, LTETDD
Remote Command	[:SENSE] :CHPower:FILTer [:RRC] :BANDwidth <real> [:SENSE] :CHPower:FILTer [:RRC] :BANDwidth?
Example	CHP:FILT:BAND 10MHz CHP:FILT:BAND?
Notes	This parameter is normally used when TETRA is selected as the Radio Std. You must be in the Spectrum Analysis mode, DVB-T/H mode, DTMB (CTTB) mode ISDB-T mode, CMMB mode, LTE mode, LTE TDD mode, or W-CDMA mode to use this command. Use :INSTRument:SElect to set the mode.
Dependencies	For CDMA2K mode, this key is blank. For 1xEVDO mode, this key is blank.
Preset	SA, LTE, LTETDD: 3.84MHz WCDMA: 3.84MHz WIMAX OFDMA: 10MHz DVB-T/H: 8MHz DTMB (CTTB): 7.56MHz ISDB-T: 5.6MHz CMMB: 7.512MHz
State Saved	Saved in instrument state.
Min	100 Hz
Max	100 MHz
Initial S/W Revision	Prior to A.02.00
Modified at S/W Revision	A.02.00, A.03.00

Filter Alpha

Inputs the alpha value for the Root Raised Cosine (RRC) filter.

Key Path	Meas Setup
Mode	SA, WCDMA, DVB-T/H, DTMB (CTTB), ISDB-T, CMMB, LTE, LTETDD
Remote Command	[:SENSE] :CHPower:FILTer [:RRC] :ALPHA <real> [:SENSE] :CHPower:FILTer [:RRC] :ALPHA?

Example	CHP:FILT:ALPH 0.5 CHP:FILT:ALPH?
Notes	This parameter is normally used when TETRA is selected as the Radio Std. You must be in the Spectrum Analysis mode, DVB-T/H mode, DTMB (CTTB) mode, ISDB-T mode, CMMB mode, LTE mode, LTE TDD mode, or W-CDMA mode to use this command. Use :INSTrument:SELEct to set the mode.
Dependencies	For CDMA2K mode, this key is blank.
Preset	SA, WCDMA, DVB-T/H, ISDB-T, CMMB, LTE, LTETDD: 0.22 DTMB (CTTB): 0.05
State Saved	Saved in instrument state.
Min	0.01
Max	1.00
Initial S/W Revision	Prior to A.02.00
Modified at S/W Revision	A.02.00, A.03.00

PSD Unit

Sets the unit bandwidth for Power Spectral Density. The available units are dBm/Hz and dBm/MHz.

Key Path	Meas Setup
Mode	SA, WCDMA, C2K, WIMAX OFDMA, 1xEVDO, DVB-T/H, DTMB (CTTB), LTE, LTETDD
Remote Command	:UNIT:CHPower:POWer:PSD DBMHZ DBMMHZ :UNIT:CHPower:POWer:PSD?
Example	UNIT:CHP:POW:PSD DBMMHZ UNIT:CHP:POW:PSD?
Couplings	When the PSD unit is changed, the PSD result of the “MEAS READ FETCH:CHP1?” is also changed by the PSD unit basis (in either dBm/Hz or dBm/MHz).
Preset	DBMHZ
State Saved	Saved in instrument state.
Range	dBm/Hz dBm/MHz
Initial S/W Revision	Prior to A.02.00
Modified at S/W Revision	A.02.00, A.03.00

Meas Preset

Restores all the measurement parameters to their default values.

Key Path	Meas Setup
Mode	SA, WCDMA, C2K, WIMAX OFDMA, 1xEVDO, DVB-T/H, DTMB (CTTB), ISDB-T, CMMB, LTE, LTETDD
Remote Command	:CONFIgure:CHPower
Example	CONF:CHP
Initial S/W Revision	Prior to A.02.00
Modified at S/W Revision	A.02.00, A.03.00

Shoulder Offset Start (Only for DVB-T/H and ISDB-T mode)

Specifies the start offset frequency from the center frequency used in calculating the shoulder attenuation results.

Key Path	Meas Setup
Mode	DVB-T/H, ISDB-T
Remote Command	[:SENSe] :CHPower:SHOUldeR:OFFSet:FREQuency:STARt <freq> [:SENSe] :CHPower:SHOUldeR:OFFSet:FREQuency:STARt?
Example	CHP:SHOU:OFFS:FREQ:STAR 3.3MHz CHP:SHOU:OFFS:FREQ:STAR?
Notes	You must be in the ISDB-T mode to use this command. Use :INSTrument:SElect to set the mode.
Couplings	The minimum value of the shoulder offset start frequency is coupled with integration bandwidth, the maximum value of the shoulder offset start frequency is coupled with shoulder offset stop frequency.
Preset	DVB-T/H: 4.105MHz ISDB-T: 3.3MHz
State Saved	Saved in instrument state.
Min	100 Hz
Max	1.0 GHz
Initial S/W Revision	A.03.00

Shoulder Offset Stop (Only for DVB-T/H and ISDB-T mode)

Specifies the stop offset frequency from the center frequency used in calculating the shoulder attenuation

results.

Key Path	Meas Setup
Mode	DVB-T/H, ISDB-T
Remote Command	[:SENSe] :CHPower:SHOUlder:OFFSet:FREQuency:STOP <freq> [:SENSe] :CHPower:SHOUlder:OFFSet:FREQuency:STOP?
Example	CHP:SHOU:OFFS:FREQ:STOP 3.5MHz CHP:SHOU:OFFS:FREQ:STOP?
Notes	You must be in the ISDB-T mode to use this command. Use :INSTrument:SElect to set the mode.
Couplings	The minimum value of the shoulder offset stop frequency is coupled with shoulder offset start frequency, the maximum value of the shoulder offset stop frequency is coupled with span.
Preset	DVB-T/H: 4.505MHz ISDB-T: 3.5MHz
State Saved	Saved in instrument state.
Min	100 Hz
Max	1.0 GHz
Initial S/W Revision	A.03.00

Shoulder Offset (Only for DTMB (CTTB) and CMMB mode)

Specifies the offset frequency from the center frequency used in calculating the shoulder attenuation results.

Key Path	Meas Setup
Mode	DTMB (CTTB), CMMB
Remote Command	[:SENSe] :CHPower:SHOUlder:OFFSet:FREQuency <freq> [:SENSe] :CHPower:SHOUlder:OFFSet:FREQuency?
Example	CHP:SHOU:OFFS:FREQ 4.2MHz CHP:SHOU:OFFS:FREQ?
Notes	You must be in the CMMB mode to use this command. Use :INSTrument:SElect to set the mode.
Couplings	The minimum value of the shoulder offset frequency is coupled with integration bandwidth, the maximum value of the shoulder offset frequency is coupled with span.
Preset	4.2MHz

Channel Power Measurement
Meas Setup

State Saved	Saved in instrument state.
Min	100 Hz
Max	1.0 GHz
Initial S/W Revision	A.03.00

Mode

See [“Mode” on page 1123](#) in the "Common Measurement Functions" section for more information.

Mode Setup

See “[Mode Setup](#)” on page 1141 in the "Common Measurement Functions" section for more information.

Peak Search

Places the selected marker on the trace point with the maximum y-axis value. Pressing Peak Search with the selected marker Off causes the selected marker to be set to Normal, then a peak search is immediately performed.

Key Path	Front panel key
Mode	SA, WCDMA, C2K, WIMAX OFDMA, 1xEVDO, DVB-T/H, DTMB (CTTB), ISDB-T, CMMB, LTE, LTETDD
Remote Command	:CALCulate:CHPower:MARKer [1] 2 3 4 5 6 7 8 9 10 11 12 :MAXimum
Example	CALC:CHP:MARK2:MAX
Initial S/W Revision	Prior to A.02.00
Modified at S/W Revision	A.02.0, A.03.000

Recall

See “[Recall](#)” on page 153 in the "Common Measurement Functions" section for more information.

Restart

See [“Restart” on page 1163](#) in the "Common Measurement Functions" section for more information.

Save

See “[Save](#)” on page 170 in the "Common Measurement Functions" section for more information.

Single

See [“Single \(Single Measurement/Sweep\)”](#) on page 1169 in the "Common Measurement Functions" section for more information.

Source

See “[Source](#)” on page 1171 in the "Common Measurement Functions" section for more information.

Span X Scale

Accesses a menu of functions that enable you set the horizontal scale parameters.

Key Path	Front-panel key
Initial S/W Revision	Prior to A.02.00

Span

Changes the frequency range symmetrically about the center frequency.

The default (and minimum) Span is calculated using the number of carriers and the carrier width where;

$$\text{Span} = (\text{Upper Carrier Freq} + (\text{max offset IBW} * (1 + \alpha)) / 2) - (\text{Lower Carrier Freq} - (\text{max offset IBW} * (1 + \alpha)) / 2)$$

The span is increased by a factor of 1 + Filter Alpha if the RRC Filter is on.

Key Path	Span X Scale
Mode	SA, WCDMA, C2K, WIMAX OFDMA, 1xEVDO, DVB-T/H, DTMB (CTTB), ISDB-T, CMMB, LTE, LTETDD
Remote Command	[:SENSe] :CHPower:FREQuency:SPAN <freq> [:SENSe] :CHPower:FREQuency:SPAN?
Example	CHP:FREQ:SPAN 10 MHz CHP:FREQ:SPAN?
Notes	You must be in the Spectrum Analysis mode, W-CDMA mode, cdma2000 mode, DVB-T/H mode, DTMB (CTTB) mode, ISDB-T mode, CMMB mode, LTE mode, LTE TDD mode 1xEVDO mode or WIMAX OFDMA mode to use this command. Use :INSTRument:SElect to set the mode.
Couplings	When Res BW is set to Auto, the resolution bandwidth is auto-coupled to span. The ratio of span /RBW is approximately 106:1. When the Res BW is set to Man, bandwidths are entered by the user, and these bandwidths are used regardless of other analyzer settings. Since Span is coupled to Integ BW in the factory default condition, if you change the integration bandwidth setting, the span setting changes by a proportional amount until a limit value is reached. However, the span can be individually set. The minimum value of the span is coupled with the integration bandwidth.

Channel Power Measurement
Span X Scale

Preset	SA: 3 MHz WCDMA: 7.5 MHz C2K: 1.845 MHz WIMAX OFDMA: 20 MHz 1xEVDO: 2.0MHz DVB-T/H: 10MHz DTMB (CTTB): 10MHz ISDB-T: 10MHz CMMB: 10MHz LTE: 7.5 MHz LTETDD: 7.5 MHz
State Saved	Saved in instrument state.
Min	100 Hz
Max	1 GHz
Max	RF Input: 1 GHz
Initial S/W Revision	Prior to A.02.00
Modified at S/W Revision	A.02.00, A.03.00

Full Span

Changes the span to show the full frequency range of the spectrum analyzer.

Key Path	Span X Scale
Mode	SA, WCDMA, C2K, WIMAX OFDMA, 1xEVDO, DVB-T/H, DTMB (CTTB), ISDB-T, CMMB, LTE, LTETDD
Remote Command	[:SENSe] :CHPower:FREQuency:SPAN:FULL
Example	CHP:FREQ:SPAN:FULL
Notes	You must be in the Spectrum Analysis mode, W-CDMA mode, cdma2000 mode, DVB-T/H mode, DTMB (CTTB) mode, ISDB-T mode, CMMB mode, LTE mode, LTE TDD mode, 1xEVDO mode or WIMAX OFDMA mode to use this command. Use :INSTrument:SElect to set the mode.
Couplings	Selecting full span changes the measurement span value.
Initial S/W Revision	Prior to A.02.00
Modified at S/W Revision	A.02.00, A.03.00

Last Span

Changes the span to the previous span setting. If no previous span value exists, then the span remains unchanged.

Key Path	Span X Scale
Mode	SA, WCDMA, C2K, WIMAX OFDMA, 1xEVDO, DVB-T/H, DTMB (CTTB), ISDB-T, CMMB, LTE, LTETDD
Remote Command	[:SENSe] :CHPower:FREQuency:SPAN:PREVIOUS
Example	CHP:FREQ:SPAN:PREV
Notes	You must be in the Spectrum Analysis mode, W-CDMA mode, cdma2000 mode, DVB-T/H mode, DTMB (CTTB) mode, ISDB-T mode, CMMB mode, LTE mode, LTE TDD mode, 1xEVDO mode or WIMAX OFDMA mode to use this command. Use :INSTrument:SELEct to set the mode.
Couplings	Selecting last span changes the measurement span value.
Initial S/W Revision	Prior to A.02.00
Modified at S/W Revision	A.02.00, A.03.00

Sweep/Control

Accesses a menu of functions that enable you to set up and control the sweep time and source for the current measurement. See “Sweep/Control” on page 1181 in the "Common Measurement Functions" section for more information.

Key Path	Front-panel key
Initial S/W Revision	Prior to A.02.00

Sweep Time

Selects the length of time that the spectrum analyzer sweeps the displayed frequency span. Additional overhead time, which impacts the sweep rate, is not calculated as part of the sweep time. In fact:

- sweep rate = span/sweep time
- update rate = 1/(sweep time + overhead)
- sweep cycle time = sweep time + overhead

Sweep time is coupled to RBW and VBW, and is impacted by the number of sweep points, so changing those parameters may change the sweep time.

Key Path	Sweep/Control
Mode	SA, WCDMA, C2K, WIMAX OFDMA, 1xEVDO, DVB-T/H, DTMB (CTTB), ISDB-T, CMMB, LTE, LTETDD
Remote Command	[:SENSe]:CHPower:SWEep:TIME <time> [:SENSe]:CHPower:SWEep:TIME? [:SENSe]:CHPower:SWEep:TIME:AUTO OFF ON 0 1 [:SENSe]:CHPower:SWEep:TIME:AUTO?
Example	CHP:SWE:TIME 25ms CHP:SWE:TIME? CHP:SWE:TIME:AUTO OFF CHP:SWE:TIME:AUTO?

Preset	SA, WIMAX OFDMA: Automatically Calculated WCDMA: 1.0 ms CDMA2K: 9.4ms 1xEVDO: 2.66ms DVB-T/H: Automatically Calculated DTMB (CTTB): Automatically Calculated ISDB-T: Automatically Calculated CMMB: Automatically Calculated LTE: Automatically Calculated LTETDD: Automatically Calculated
State Saved	Saved in instrument state.
Min	1 ms
Max	4000 s
Initial S/W Revision	Prior to A.02.00
Modified at S/W Revision	A.02.00, A.03.00

Sweep Setup

Accesses a menu that enables you to set the sweep state for the current measurement.

Key Path	Sweep/Control
Initial S/W Revision	Prior to A.02.00

Auto Sweep Time Rules

Switches the analyzer between normal and accuracy sweep states.

Setting **Auto Sweep Time** to **Accy** results in slower sweep times, usually about three times as long, but yields better amplitude accuracy for CW signals. The instrument amplitude accuracy specifications only apply when **Auto Sweep Time** is set to **Accy**.

Additional amplitude errors which occur when **Auto Sweep Time** is set to **Norm** are usually well under 0.1 dB, though this is not guaranteed. Because of the faster sweep times and still low errors, **Norm** is the preferred setting of **Auto Sweep Time**. **Auto Sweep Time** is set to **Norm** on a **Preset** or **Auto Couple**. This means that in the Preset or Auto Coupled state, instrument amplitude accuracy specifications do not apply.

Key Path	Sweep/Control, Sweep Setup
Mode	SA, WCDMA, C2K, WIMAX OFDMA, 1xEVDO, DVB-T/H, DTMB (CTTB), ISDB-T, CMMB, LTE, LTETDD

Remote Command	[:SENSe] :CHPower:SWEep:TIME:AUTO:RULes NORMal ACCuracy [:SENSe] :CHPower:SWEep:TIME:AUTO:RULes?
Example	CHP:SWE:TIME:AUTO:RUL NORM CHP:SWE:TIME:AUTO:RUL?
Notes	In Zero Span, this key is irrelevant and inaccessible (because the whole Sweep Setup menu is grayed out in Zero Span), however its settings can be changed remotely with no error indication. Set to Norm when Auto Couple is pressed or sent remotely
Preset	NORMal
State Saved	Saved in instrument state.
Range	Norm Accy
Initial S/W Revision	Prior to A.02.00
Modified at S/W Revision	A.02.00, A.03.00

Pause

Pauses a measurement after the current data acquisition is complete. When Paused, the label on the key changes to Resume. Pressing the Resume key resumes the measurement at the point it was at when paused. See [“Pause/Resume” on page 1193](#) in “Common Measurement Functions” section for more details.

Key Path	Sweep/Control
Initial S/W Revision	Prior to A.02.00

Gate

Accesses a menu that enables you to control the gating function. See [“Gate ” on page 1194](#) in "Common Measurement Functions" section for more details.

The Gate functionality is used to view signals best viewed by qualifying them with other events.

Key Path	Sweep/Control
Initial S/W Revision	Prior to A.02.00

Points

Sets the number of points per sweep. The resolution of setting the sweep time depends on the number of points selected. If Preset is selected, the number of points per sweep defaults to 1001. The current value of points is displayed parenthetically, next to the sweep time in the lower-right corner of the display.

Changing the number of points has several effects on the analyzer. Since markers are read at the point

location, the marker reading may change. All trace data is cleared.

Key Path	Sweep/Control
Mode	SA, WCDMA, C2K, WIMAX OFDMA, 1xEVDO, DVB-T/H, DTMB (CTTB), ISDB-T, CMMB, LTE, LTETDD
Remote Command	[:SENSe] :CHPower:SWEep:POINts <integer> [:SENSe] :CHPower:SWEep:POINts?
Example	CHP:SWE:POIN 501 CHP:SWE:POIN?
Notes	Whenever the number of sweep points change: All trace data is erased Any traces with Update Off also go to Display Off (like going from View to Blank in the older analyzers) Sweep time is re-quantized Any limit lines that are on are updated If averaging/hold is on, averaging/hold starts over
Couplings	Whenever the number of sweep points change, the sweep time is re-quantized.
Preset	DVB-T/H: 2001 DTMB (CTTB): 2001 Other: 1001 ISDB-T: 2001 CMMB: 2001
State Saved	Saved in instrument state.
Min	101
Max	20001
Initial S/W Revision	Prior to A.02.00
Modified at S/W Revision	A.02.00, A.03.00

Trace/Detector

Accesses a menu of functions that enable you to control the detectors for the current measurement.

Key Path	Front-panel key
Initial S/W Revision	Prior to A.02.00

Trace Type

Allows you to select the type of trace you want to use for the current measurement. The first page of this menu contains a 1-of-N selection of the trace type (**Clear Write, Average, Max Hold, Min Hold**) for the selected trace.

Key Path	Trace/Detector
Mode	SA, WCDMA, C2K, WIMAX OFDMA, 1xEVDO, DVB-T/H, DTMB (CTTB), ISDB-T, CMMB, LTE, LTETDD
Remote Command	:TRACe:CHPower:TYPE WRITe AVERAge MAXHold MINHold :TRACe:CHPower:TYPE?
Example	TRAC:CHP:TYPE WRIT TRAC:CHP:TYPE?
Notes	WRITe = Clear Write AVERAge = Average MAXHold = Maximum Hold MINHold = Minimum Hold
Couplings	When Detector setting is “Auto” ([:SENSe]:CHPower:DETEctor:AUTO?), Detector ([:SENSe]:CHPower:DETEctor[:FUNCTion]?) switches aligning with the switch of this parameter: “NORMal” with WRITe (Clear Write), “AVERAge” with AVERAge, “POSitive (peak)” with MAXHold, and “NEGative (peak)” with MINHold.
Preset	AVERAge
State Saved	Saved in instrument state.
Range	ClearWrite Average MaxHold MinHold
Initial S/W Revision	Prior to A.02.00
Modified at S/W Revision	A.02.00, A.03.00

Detector

Accesses a menu of functions that enable you to control the detectors for the current measurement. The following choices are available:

- Auto- the detector selected depends on marker functions, trace functions, average type, and the trace averaging function.
- Normal-the detector determines the peak of the CW-like signals, and it yields alternating maximums and minimums of noise-like signals. This is also referred to as Rosenfell detection.
- Average-the detector determines the average of the signal within the sweep points. The averaging method depends upon the Average Type selection (voltage, power or log scales).
- Peak-the detector determines the maximum of the signal within the sweep points.
- Sample-the detector indicates the instantaneous level of the signal at the center of the sweep points represented by each display point.
- Negative Peak-the detector determines the minimum of the signal within the sweep points.

Key Path	Detector
Initial S/W Revision	Prior to A.02.00

Detector Selection

Selects a detector to be used by the analyzer for the current measurement.

Key Path	Trace/Detector
Mode	SA, WCDMA, C2K, WIMAX OFDMA, 1xEVDO, DVB-T/H, DTMB (CTTB), ISDB-T, CMMB, LTE, LTETDD
Remote Command	[:SENSE] :CHPower:DETECTOR[:FUNCTION] NORMal AVERAge POSitive SAMPlE NEGative [:SENSE] :CHPower:DETECTOR[:FUNCTION] ?
Example	CHP:DET NORM CHP:DET?
Notes	<p>When you manually select a detector (instead of selecting Auto), that detector is used regardless of other analyzer settings.</p> <p>The Normal detector determines the peak of CW-like signals, and it yields alternating maximums and minimums of noise-like signals. This method of detection is also referred to as Rosenfell detection.</p> <p>The Average detector determines the average of the signal within the sweep points. The averaging method is Power Average (RMS).</p> <p>The Peak detector determines the maximum of the signal within the sweep points.</p> <p>The Sample detector indicates the instantaneous level of the signal at the center of the sweep points represented by each display point.</p> <p>The Negative Peak detector determines the minimum of the signal within the sweep points.</p>

Channel Power Measurement
Trace/Detector

Couplings	When Detector setting is “Auto” ([:SENSe]:CHPower:DETECTOR:AUTO?), Detector ([:SENSe]:CHPower:DETECTOR[:FUNCTION]?) switches aligning with the switch of this parameter: “NORMAl” with Clear Write, “AVERAge” with AVERAge, “POSitive (peak)” with MAXHold, and “NEGative (peak)” with MINHold.
Preset	AVERAge
State Saved	Saved in instrument state.
Range	Normal Average Peak Sample Negative Peak
Initial S/W Revision	Prior to A.02.00
Modified at S/W Revision	A.02.00, A.03.00

Auto

Sets the detector for the currently selected trace to Auto.

Key Path	Trace/Detector
Mode	SA, WCDMA, C2K, WIMAX OFDMA, 1xEVDO, DVB-T/H, DTMB (CTTB), ISDB-T, CMMB, LTE, LTETDD
Remote Command	[:SENSe] :CHPower:DETECTOR:AUTO ON OFF 1 0 [:SENSe] :CHPower:DETECTOR:AUTO?
Example	CHP:DET:AUTO ON CHP:DET:AUTO?
Couplings	When Detector setting is “Auto” ([:SENSe]:CHPower:DETECTOR:AUTO?), Detector ([:SENSe]:CHPower:DETECTOR[:FUNCTION]?) switches aligning with the switch of this parameter: “NORMAl” with Clear Write, “AVERAge” with AVERAge, “POSitive (peak)” with MAXHold, and “NEGative (peak)” with MINHold.
Preset	Others: ON DVB-T/H, DTMB (CTTB), ISDB-T, CMMB: OFF
State Saved	Saved in instrument state.
Initial S/W Revision	Prior to A.02.00
Modified at S/W Revision	A.02.00, A.03.00

Trigger

Accesses a menu of functions that enable you to select and control the trigger source for the current measurement.

See [“Trigger” on page 1251](#) in the "Common Measurement Functions" section for more information.

Key Path	Front-panel key
Initial S/W Revision	Prior to A.02.00

View/Display

Accesses a menu of functions that enable you to control the instrument display as well as turn the bar graph On and Off.

If current mode is NOT DVB-T/H, DTMB (CTTB), ISDB-T or CMMB mode, the front panel views only contain one view: Spectrum View. It can be displayed as a single spectrum trace view or displayed with a Bar Graph trace on the spectrum trace

The results of the measurement can be displayed as a single spectrum trace view or displayed with a Bar Graph trace on the spectrum trace.

Spectrum View with Bar Graph off

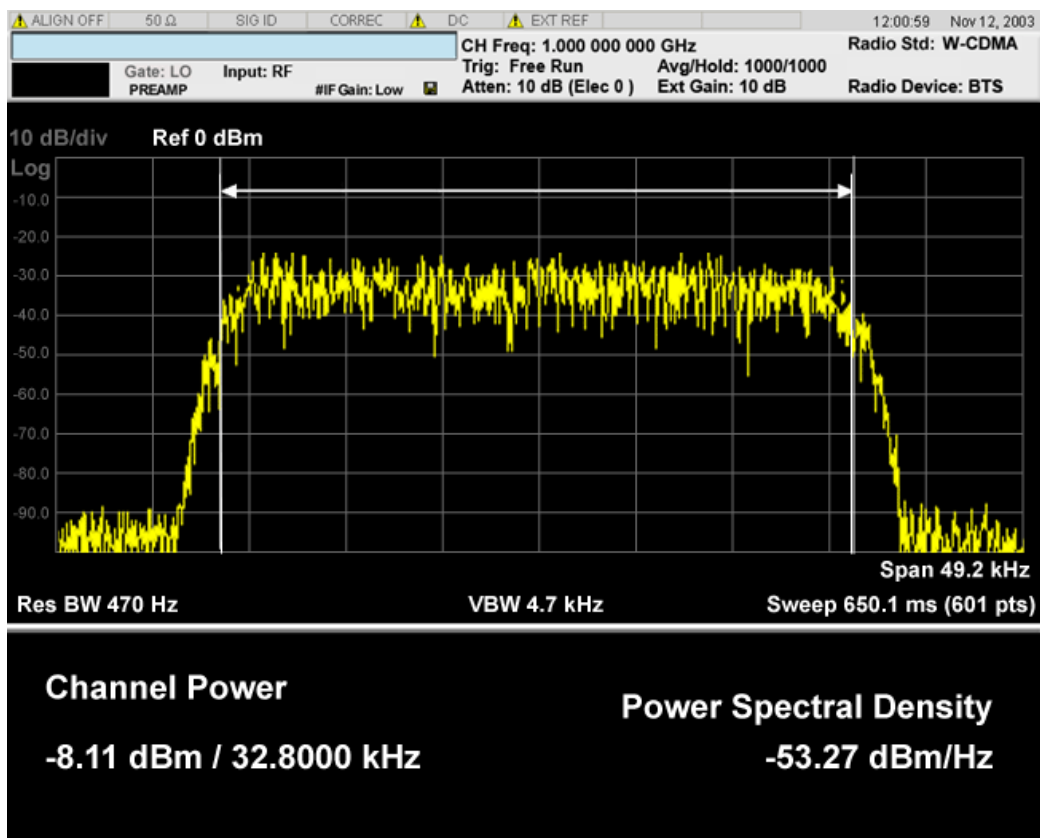

Spectrum View with Bar Graph on

This View is the same as the 'Spectrum' view, but has a blue bar between the markers that indicates the measured output power level. The bar graph is activated when the "Bar Graph" Soft Key is set to ON under the View/Display menu. The actual measured output power level is displayed on the display at the bottom of the bar.

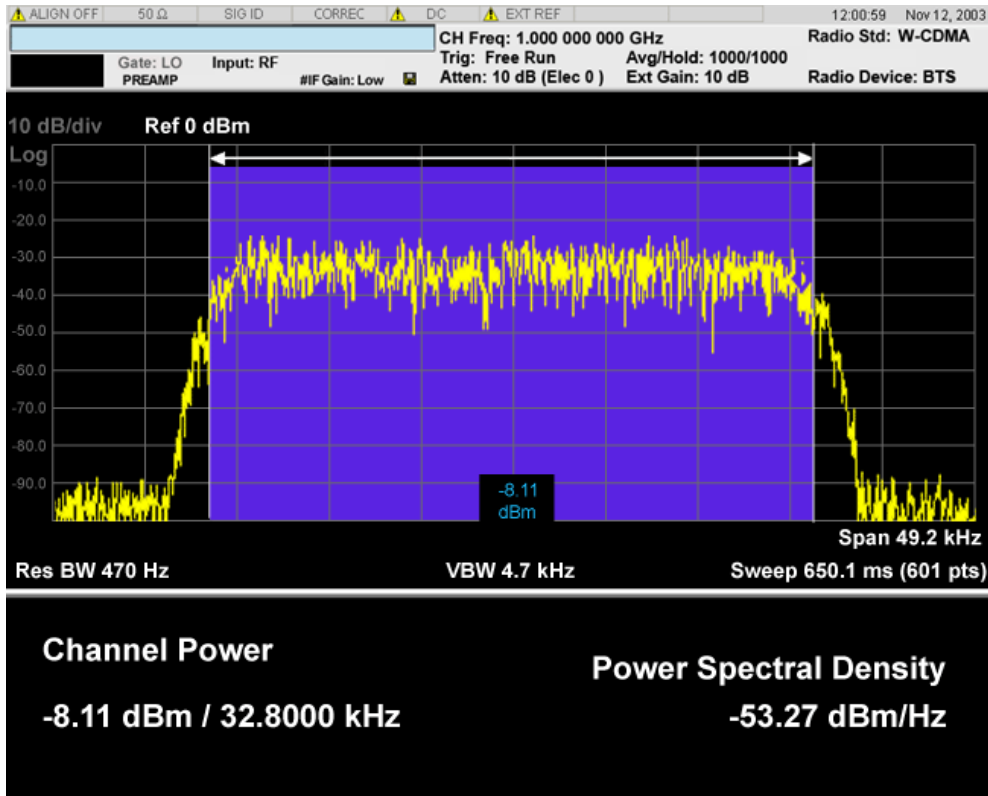

If current mode is DVB-T/H or DTMB (CTTB), the front panel views contain three views: RF Spectrum View, Shoulder Attenuation View and Spectrum Mask View.

If current mode is ISDB-T or CMMB, the front panel views contain two views: RF Spectrum View and Shoulder Attenuation View.

The RF Spectrum View is the common view, the same as the Spectrum view, and the Shoulder Attenuation View and Spectrum Mask View are special view for DVB-T/H, DTMB (CTTB), ISDB-T and CMMB.

View selection by name (DTMB (CTTB), DVB-T/H only)

Selects the results view. The following SCPI command allows you to select the desired measurement view by enumeration.

Key Path	View/Display
Mode	DVB-T/H, DTMB (CTTB)
Remote Command	:DISPlay:CHPower:VIEW[:SElect] RFSPectrum SHOULder MASK :DISPlay:CHPower:VIEW[:SElect] ?
Example	DISP:CHP:VIEW RFSP DISP:CHP:VIEW?
Preset	RFSPectrum

Channel Power Measurement View/Display

State Saved	Saved in instrument state.
Range	RF Spectrum Shoulder Attenuation Spectrum Mask
Initial S/W Revision	A.02.00

View selection by name (ISDB-T, CMMB only)

Selects the results view. The following SCPI command allows you to select the desired measurement view by enumeration.

Key Path	View/Display
Mode	ISDB-T, CMMB
Remote Command	:DISPlay:CHPower:VIEW[:SElect] RFSPectrum SHOUlder :DISPlay:CHPower:VIEW[:SElect]?
Example	DISP:CHP:VIEW RFSP DISP:CHP:VIEW?
Preset	RFSPectrum
State Saved	Saved in instrument state.
Range	RF Spectrum Shoulder Attenuation
Initial S/W Revision	A.03.00

Key Path	Front-panel key
Initial S/W Revision	Prior to A.02.00

Display

Accesses a menu of functions that enable you to set the display parameters.

See [“Display” on page 1313](#) in the "Common Measurement Functions" section for more information.

Key Path	View/Display
Initial S/W Revision	Prior to A.02.00

Bar Graph

Turns the Bar Graph On and Off.

Key Path	DVB-T/H, DTMB (CTTB), ISDB-T, CMMB: View/Display, RF Spectrum Others: View/Display
Mode	SA, WCDMA, C2K, WIMAX OFDMA, 1xEVDO, DVB-T/H, DTMB (CTTB), ISDB-T, CMMB, LTE, LTETDD

Remote Command	:DISPlay:CHPower:VIEW[1]:WINDow[1]:BGRaph ON OFF 1 0 :DISPlay:CHPower:VIEW[1]:WINDow[1]:BGRaph?
Example	DISP:CHP:VIEW:WIND:BGR ON DISP:CHP:VIEW:WIND:BGR?
Notes	You must be in the Spectrum Analysis mode, W-CDMA mode, cdma2000 mode, DVB-T/H mode, DTMB (CTTB) mode, ISDB-T mode, CMMB mode, LTE mode, LTE TDD mode, 1xEVDO mode or WIMAX OFDMA mode to use this command. Use :INSTrument:SElect to set the mode.
Preset	OFF
State Saved	Saved in instrument state.
Range	On Off
Initial S/W Revision	Prior to A.02.00
Modified at S/W Revision	A.02.00, A.03.00

RF Spectrum (Only for DVB-T/H, DTMB (CTTB), ISDB-T and CMMB)

NOTE This view is the same as the Spectrum View above.

Selects the RF Spectrum view. This view consists of the following two windows:

“Traces Window” on page 358

“Results Window” on page 358

The measurement results are shown in a graph window and in a text window. The text window shows the absolute power and its mean power spectral density values over the specified bandwidth. This view also supports bar graph functionality. The bar graph is activated when the “Bar Graph” Soft Key is set to ON under the RF Spectrum menu. The actual measured output power level is displayed on the display at the bottom of the bar.

Channel Power Measurement
View/Display

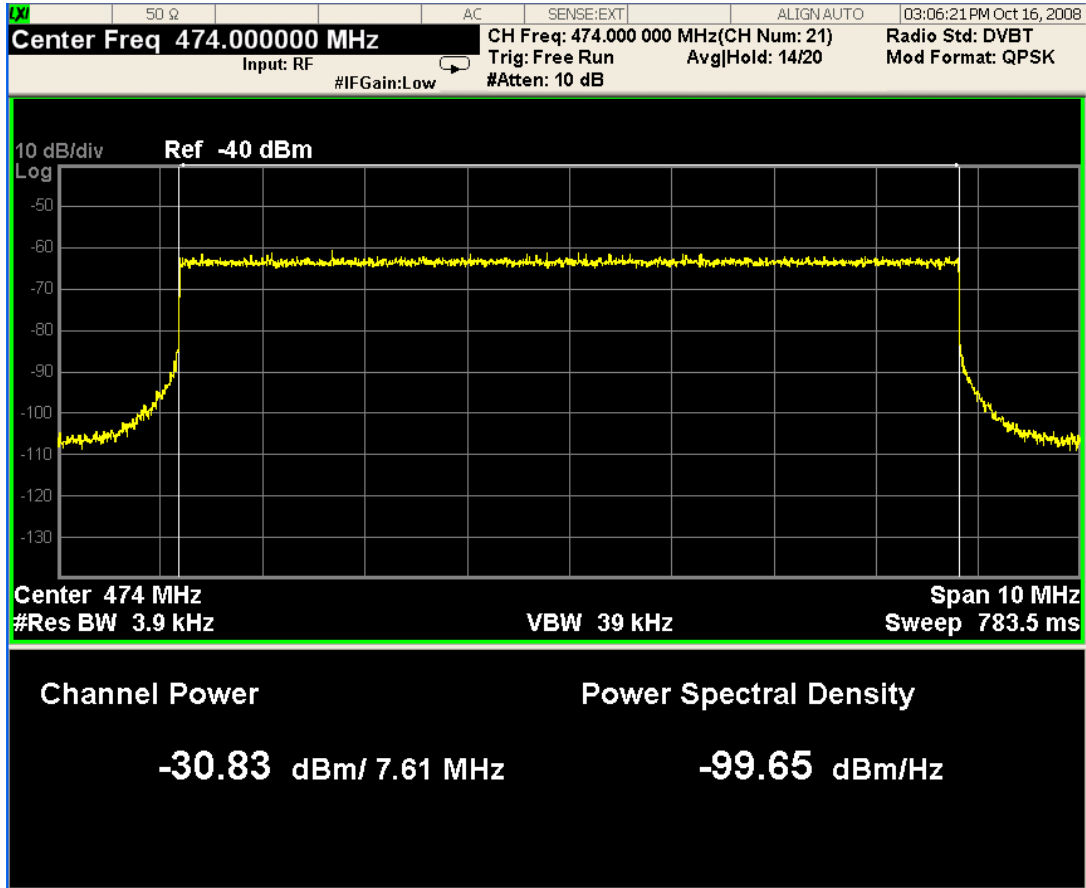

Traces Window

Corresponding Trace	yellow - spectrum trace;
---------------------	--------------------------

Results Window

Name	Corresponding Results
Channel Power	n=1, 1st element Total channel power in the specified integration bandwidth
	Channel Integration Bandwidth
Power Spectral Density	n=1, 2nd element The power in the specified unit bandwidth

Key Path	View/Display
Example	DISP:CHP:VIEW RFSP DISP:CHP:VIEW?

Initial S/W Revision	A.02.00
----------------------	---------

Shoulder Attenuation (Only for DVB-T/H, DTMB (CTTB), ISDB-T and CMMB)

Selects the Shoulder Attenuation view. This view is only available in DVB-T/H, DTMB (CTTB), ISDB-T and CMMB mode:

“Shoulder Attenuation view for DVB-T/H and ISDB-T mode” on page 359

“Shoulder Attenuation view for DTMB (CTTB) and CMMB mode” on page 360

This view consists of the following three windows:

“Lower Shoulder Trace Window” on page 361

“Upper Shoulder Trace Window” on page 361

“Results Window” on page 361

Shoulder Attenuation view for DVB-T/H and ISDB-T mode

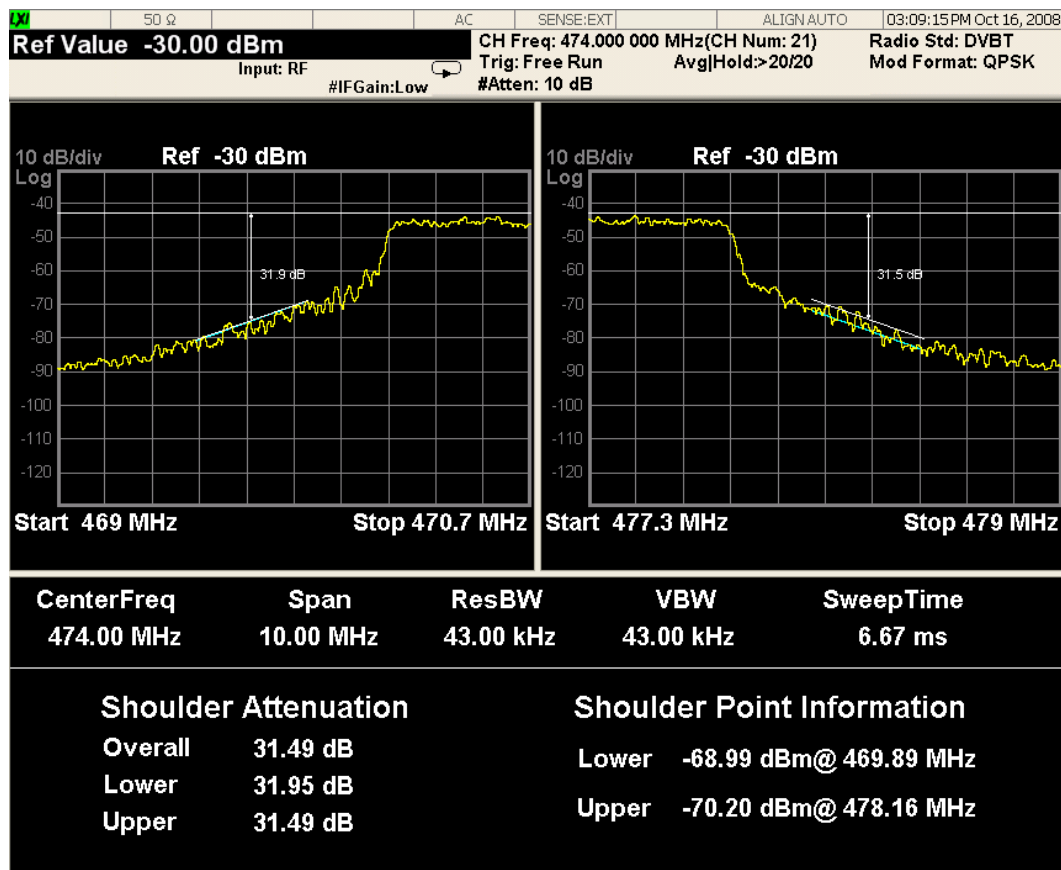

Shoulder Attenuation view for DTMB (CTTB) and CMMB mode

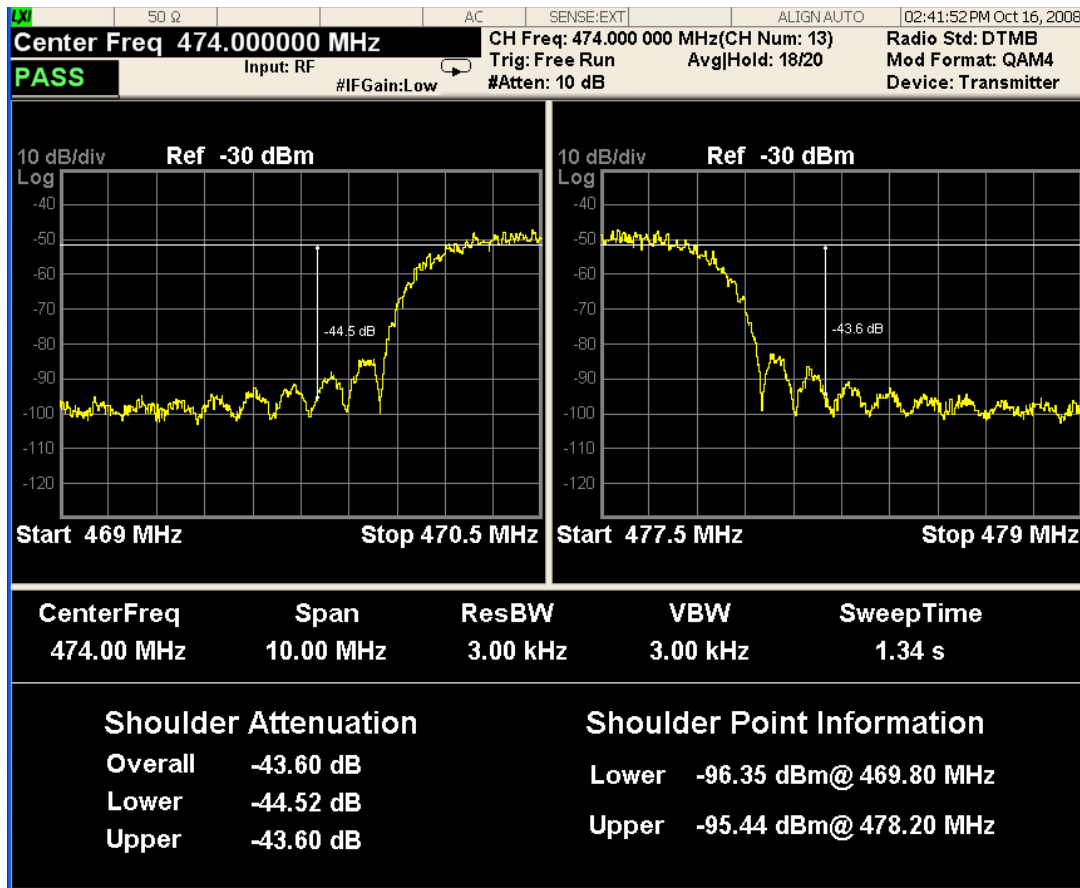

NOTE

The pass/fail function is valid only in DTMB (CTTB) and CMMB mode:

In DTMB (CTTB) mode, when the device type (under mode setup panel) is Transmitter, the pass/fail limit is -36 dBc, and for the other type – Exciter, the pass/fail limit is -48 dBc.

In CMMB mode, when the device type (under mode setup panel) is Transmitter, the pass/fail limit is -35dBc, and for the other type – Exciter, the pass/fail limit is -50dBc.

Lower Shoulder Trace Window

Corresponding Trace *	<p>yellow - lower edge of the spectrum trace;</p> <p>white - assistant lines to indicate the lower shoulder attenuation;</p> <p>(Only for DVB-T/H) cyan – assistant beeline from shoulder range begin point to the range end point;</p>
-----------------------	--

Upper Shoulder Trace Window

Corresponding Trace *	<p>yellow - upper edge of the spectrum trace;</p> <p>white - assistant lines to indicate the upper shoulder attenuation;</p> <p>(Only for DVB-T/H) cyan – assistant beeline from shoulder range begin point to the range end point;</p>
-----------------------	--

Results Window

Name	Corresponding Results
CenterFreq (MHz)	The center frequency of the measurement
Span (MHz)	The span of the measurement
ResBW (kHz)	The resolution bandwidth of the measurement
VBW (kHz)	The video bandwidth of the measurement
SweepTime (ms)	The sweep time of the measurement
Overall Shoulder Attenuation (dB)	n=3, 1st element Shoulder attenuation result
Lower Shoulder Attenuation (dB)	n=3, 2nd element Lower shoulder attenuation result
Upper Shoulder Attenuation (dB)	n=3, 3rd element Upper shoulder attenuation result
Lower Shoulder Point Power (dBm) **	n=3, 4th element The power value of the point with maximum power level in the lower edge of the spectrum
Lower Shoulder Point Frequency (MHz) **	n=3, 5th element The frequency of the point with maximum power level in the lower edge of the spectrum
Upper Shoulder Point Power (dBm) **	n=3, 6th element The power value of the point with maximum power level in the upper edge of the spectrum

Name	Corresponding Results
Upper Shoulder Point Frequency (MHz) **	n=3, 7th element The frequency of the point with maximum power level in the upper edge of the spectrum

*: For DVB-T/H mode: All three traces are valid. The cyan line is connecting the measurement points 300kHz and 700kHz from each of the upper and lower edges of the spectrum (yellow trace).

For DTMB (CTTB), ISDB-T, and CMMB mode: There are only two traces: yellow trace and white trace.

** : For DVB-T/H mode: Shoulder Point Information shows the information of the maximum power level point between the points at 300 kHz and 700 kHz from each of the upper and lower edges of the spectrum trace. It contains two parts: the frequency and the power level.

For DTMB (CTTB) mode: Shoulder Point Information shows the power level of the fixed point, which is ± 4.2 MHz away from center frequency for 8MHz radio bandwidth and ± 3.2 MHz away from center frequency for 6MHz radio bandwidth.

For ISDB-T mode: Shoulder Point Information shows the information of the maximum power level point between the frequency range of -3.3 MHz to -3.5 MHz away from center frequency of the lower channel and of $+3.3$ MHz to $+3.5$ MHz away from the center frequency of the upper channel. It contains two parts: the frequency and the power level.

For CMMB mode: Shoulder Point Information shows the power level of the fixed point, which is ± 4.2 MHz away from center frequency for 8MHz radio bandwidth. It contains the frequency and the power level of the point.

Key Path	View/Display
Example	DISP:CHP:VIEW SHOU DISP:CHP:VIEW?
Initial S/W Revision	A.02.00

Spectrum Mask(DTMB (CTTB), DVB-T/H only)

Selects the Spectrum Mask view. This view consists of the following two windows:

“Trace Window” on page 364

“Results Window” on page 364

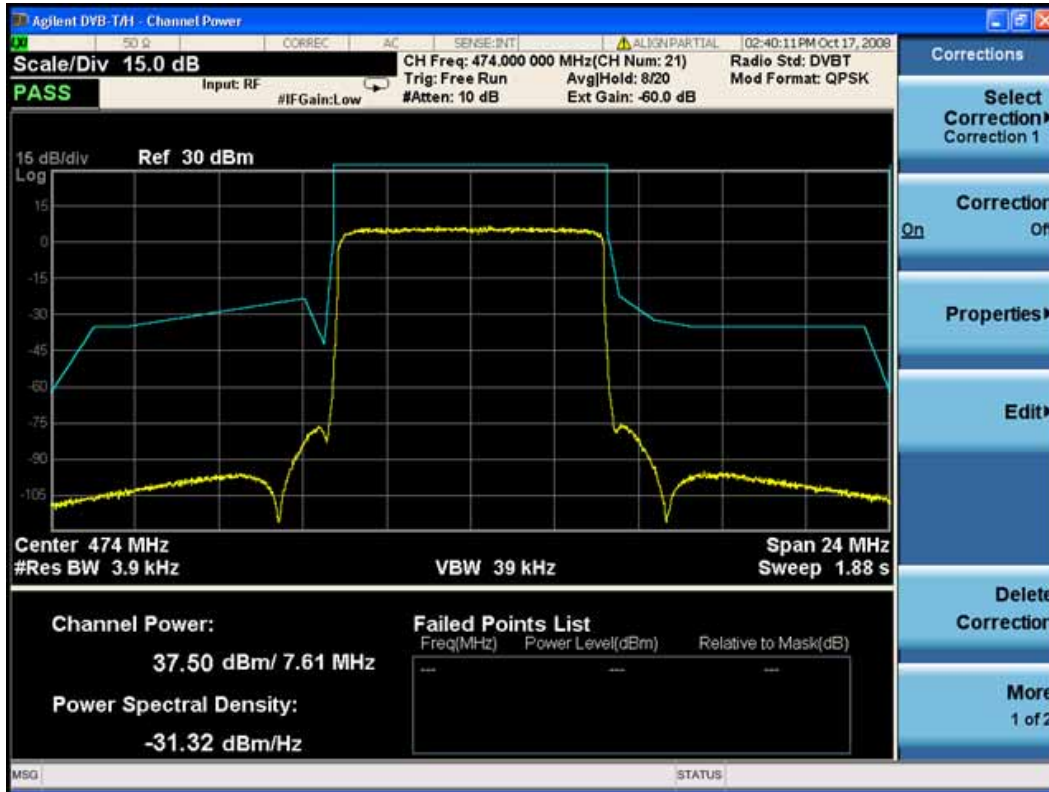

NOTE If the current radio bandwidth is not 8 MHz, the limit line (Mask) is not available and the failed points list shows “---”. The STATUS message “No Result; No mask for X MHz” appears. (X may be 5, 6 and 7 for DVB-T/H mode and 6 for DTMB (CTTB) mode.)

Trace Window

Corresponding Trace	yellow - spectrum trace; cyan - limit line trace;
---------------------	--

Results Window

Name	Corresponding Results
Channel Power	n=1, 1st element Total channel power in the specified integration bandwidth
	Channel Integration Bandwidth
Power Spectral Density	n=1, 2nd element The power in the specified unit bandwidth
Failed Points List *	n=7 The failed point's information: frequency, absolute power and relative power

*: If the number of the failed points is less than twenty, all of them (frequency, power and relative power) will be shown in the failed points list; and if the number of the failed points is more than twenty, only the first ten and the last ten failed points will be shown.

Key Path	View/Display
Example	DISP:CHP:VIEW MASK DISP:CHP:VIEW?
Initial S/W Revision	A.02.00

Mask - selection by Enum (Only for DVB-T/H mode)

Selects the mask line in the spectrum mask view. The following SCPI command allows you to select the desired mask by enumeration. It includes six kinds of limit line: L/SECAM/NICAM, G/PAL/NICAM, I/PAL/NICAM, G/PAL/A2, K/SECAM and K/PAL.

Key Path	View/Display, Spectrum Mask
Mode	DVB-T/H
Remote Command	:DISPlay:CHPower:VIEW:MASK[:SElect] LSNI GPNI IPNI GPA2 KSKP :DISPlay:CHPower:VIEW:MASK[:SElect]?
Example	DISP:CHP:VIEW:MASK LSNI DISP:CHP:VIEW:MASK?

Dependencies	If current Radio BW is not 8 MHz, the STATUS message “No result” will be displayed. But the keys under the Spectrum Mask are still displayed.
Preset	LSNI
State Saved	Saved in instrument state.
Range	LSecam_Nicam GPal_Nicam IPal_Nicam GPal_A2 KSecam_KPal
Initial S/W Revision	A.02.00

Scroll

Accesses the Scroll menu, which contains features that enable you to navigate the display.

Key Path	View/Display, Spectrum Mask
Mode	DVB-T/H, DTMB (CTTB)
Initial S/W Revision	A.02.00

Prev Page

Moves the display one page back to the previous page of the result metrics window in Spectrum Mask view.

Key Path	View/Display, Spectrum Mask, Scroll
Mode	DVB-T/H, DTMB (CTTB)
Initial S/W Revision	A.02.00

Next Page

Moves the display one page forward to the next page of the result metrics window in Spectrum Mask view.

Key Path	View/Display, Spectrum Mask, Scroll
Mode	DVB-T/H, DTMB (CTTB)
Initial S/W Revision	A.02.00

Scroll Up

Moves one line upward from the current line of the result metrics window in Spectrum Mask view.

Pressing the up arrow hard key has the same effect as this function, if no active function is shown. If an active function is shown, the up arrow hard key controls the active function, but has no effect on line movement.

Key Path	View/Display, Spectrum Mask, Scroll
Mode	DVB-T/H, DTMB (CTTB)

Channel Power Measurement
View/Display

Initial S/W Revision	A.02.00
----------------------	---------

Scroll Down

Moves one line downward from the current line of the result metrics window in Spectrum Mask view.

Pressing the down arrow hard key has the same effect as this function, if no active function is shown. If an active function is shown, the up arrow hard key controls the active function, but has no effect on line movement, as the Scroll Down function does.

Key Path	View/Display, Spectrum Mask, Scroll
Mode	DVB-T/H, DTMB (CTTB)
Initial S/W Revision	A.02.00

First Page

Moves the display to the first page of the result metrics window in Spectrum Mask view.

Key Path	View/Display, Spectrum Mask, Scroll
Mode	DVB-T/H, DTMB (CTTB)
Initial S/W Revision	A.02.00

Last Page

Moves the display to the last page of the result metrics window in Spectrum Mask view.

Key Path	View/Display, Spectrum Mask, Scroll
Mode	DVB-T/H, DTMB (CTTB)
Initial S/W Revision	A.02.00

ACP is a measurement of the amount of interference, or power, in an adjacent frequency channel. The results are displayed as a bar graph or as spectrum data, with measurement data at specified offsets. For measurement results and views, see [“View/Display” on page 472](#).

This topic contains the following sections:

[“Measurement Commands for ACP” on page 367](#)

[“Remote Command Results for ACP Measurement” on page 367](#)

Measurement Commands for ACP

The following commands are used to retrieve the measurement results:

:CONFigure:ACP

:CONFigure:ACP:NDEFault

:INITiate:ACP

:FETCh:ACP [n] ?

:READ:ACP [n] ?

:MEASure:ACP [n] ?

For more measurement related commands, see the SENSE subsystem, and the section [“Remote Measurement Functions” on page 1083](#).

Remote Command Results for ACP Measurement

Condition	n	Results Returned
Mode = SA mode, Radio Std = None, Number of carriers = 1 and only offset A is on	Not specified or n=1	Returns 3 comma-separated values that correspond to: Reference carrier power, lower-adjacent channel power (dBc), and upper-adjacent channel power (dBc).

Condition	n	Results Returned
<p>Mode = DTMB (CTTB) or CMMB, Radio BW = 8MHz, Number of carriers = 1 and Meas Type = Total power reference</p>	<p>Not specified or n=1</p>	<p>Returns 32 comma-separated scalar results, in the following order.</p> <ol style="list-style-type: none"> 1. 0.0 2. Total carrier power (dBm) 3. 0.0 4. Reference carrier power (dBm) 5. Lower offset A - relative power (dB) 6. Lower offset A - absolute power (dBm) 7. Upper offset A - relative power (dB) 8. Upper offset A - absolute power (dBm) 9. Lower offset B - relative power (dB) 10. Lower offset B - absolute power (dBm) 11. Upper offset B - relative power (dB) 12. Upper offset B - absolute power (dBm) ... 25. Lower offset F - relative power (dB) 26. Lower offset F - absolute power (dBm) 27. Upper offset F - relative power (dB) 28. Upper offset F - absolute power (dBm) 29. Inside Adjacent Channel - relative power (dB) 30. Inside Adjacent Channel - absolute power (dBm) 31. Outside Adjacent Channel - relative power (dB) 32. Outside Adjacent Channel - absolute power (dBm) <p>If Radio Device = Exciter, the last four (29, 30, 31 and 32) results returned -999.0.</p> <p>If the results are not available, -999.0 is returned.</p> <p>* Inside Adjacent Channel - absolute power: the maximum of the Lower offset A - absolute power and the Upper offset A - absolute power;</p> <p>** Inside Adjacent Channel - relative power: the result of Reference carrier power subtracted from Inside Adjacent Channel - absolute power;</p> <p>*** Outside Adjacent Channel - absolute power: the root mean square of the absolute power of the offset B upper/lower, the offset C upper/lower and the offset D upper/lower;</p> <p>**** Outside Adjacent Channel - relative power: the result of Reference carrier power subtracted from Outside Adjacent Channel - absolute power;</p>

Condition	n	Results Returned
Mode = DTMB (CTTB) or CMMB, Radio BW = 8MHz, Number of carriers = 1 and Meas Type = Power spectral density reference	not specified or n=1	Returns 32 comma-separated scalar results, in the following order. 1. 0.0 2. Total carrier power (dBm/Hz or dBm/MHz) 3. 0.0 4. Reference carrier power (dBm/Hz or dBm/MHz) 5. Lower offset A - relative power (dB) 6. Lower offset A - absolute power (dBm/Hz or dBm/MHz) 7. Upper offset A - relative power (dB) 8. Upper offset A - absolute power (dBm/Hz or dBm/MHz) 9. Lower offset B - relative power (dB) 10. Lower offset B - absolute power (dBm/Hz or dBm/MHz) 11. Upper offset B - relative power (dB) 12. Upper offset B - absolute power (dBm/Hz or dBm/MHz) ... 25. Lower offset F - relative power (dB) 26. Lower offset F - absolute power (dBm/Hz or dBm/MHz) 27. Upper offset F - relative power (dB) 28. Upper offset F - absolute power (dBm/Hz or dBm/MHz) 29. -999.0 30. -999.0 31. -999.0 32. -999.0 The last four (29, 30, 31 and 32) results always returned -999.0. If the results are not available, -999.0 is returned.

Condition	n	Results Returned
Meas Type = Total power reference	Not specified or n=1	<p>Returns 28 comma-separated scalar results, in the following order.</p> <ol style="list-style-type: none"> 1. 0.0 2. Total carrier power (dBm) 3. 0.0 4. Reference carrier power (dBm) 5. Lower offset A - relative power (dB) 6. Lower offset A - absolute power (dBm) 7. Upper offset A - relative power (dB) 8. Upper offset A - absolute power (dBm) 9. Lower offset B - relative power (dB) 10. Lower offset B - absolute power (dBm) 11. Upper offset B - relative power (dB) 12. Upper offset B - absolute power (dBm) ... 25. Lower offset F - relative power (dB) 26. Lower offset F - absolute power (dBm) 27. Upper offset F - relative power (dB) 28. Upper offset F - absolute power (dBm) <p>If the results are not available, -999.0 is returned.</p>

Condition	n	Results Returned
Meas Type = Power spectral density reference	not specified or n=1	<p>Returns 28 comma-separated scalar results, in the following order.</p> <ol style="list-style-type: none"> 1. 0.0 2. Total carrier power (dBm/Hz or dBm/MHz) 3. 0.0 4. Reference carrier power (dBm/Hz or dBm/MHz) 5. Lower offset A - relative power (dB) 6. Lower offset A - absolute power (dBm/Hz or dBm/MHz) 7. Upper offset A - relative power (dB) 8. Upper offset A - absolute power (dBm/Hz or dBm/MHz) 9. Lower offset B - relative power (dB) 10. Lower offset B - absolute power (dBm/Hz or dBm/MHz) 11. Upper offset B - relative power (dB) 12. Upper offset B - absolute power (dBm/Hz or dBm/MHz) ... 25. Lower offset F - relative power (dB) 26. Lower offset F - absolute power (dBm/Hz or dBm/MHz) 27. Upper offset F - relative power (dB) 28. Upper offset F - absolute power (dBm/Hz or dBm/MHz) <p>If the results are not available, -999.0 is returned.</p>
Meas Method = FAST	not specified or n=1	<p>Returns 5 comma-separated results, in the following order:</p> <ol style="list-style-type: none"> 1. Reference carrier - absolute power (dBm) 2. Lower offset A - absolute power (dBm) 3. Upper offset A - absolute power (dBm) 4. Lower offset B - absolute power (dBm) 5. Upper offset B - absolute power (dBm)

Condition	n	Results Returned
Meas Type = Total power reference	2	<p>Returns 48 scalar results, in the following order:</p> <ol style="list-style-type: none"> 1. Channel (1) - relative power (dB) 2. Channel (1) - absolute power (dBm) 3. Channel (2) - relative power (dB) 4. Channel (2) - absolute power (dBm) ... 23. Channel (12) - relative power (dB) 24. Channel (12) - absolute power (dBm) 25. Lower offset A - relative power (dB) 26. Lower offset A - absolute power (dBm) 27. Upper offset A - relative power (dB) 28. Upper offset A - absolute power (dBm) 29. Lower offset B - relative power (dB) 30. Lower offset B - absolute power (dBm) 31. Upper offset B - relative power (dB) 32. Upper offset B - absolute power (dBm) ... 45. Lower offset F - relative power (dB) 46. Lower offset F - absolute power (dBm) 47. Upper offset F - relative power (dB) 48. Upper offset F - absolute power (dBm) <p>If the results are not available, -999.0 is returned.</p>

Condition	n	Results Returned
Meas Type = Power spectral density reference	2	<p>Returns 48 scalar results, in the following order:</p> <ol style="list-style-type: none"> 1. Channel (1) - relative power (dB) 2. Channel (1) - absolute power (dBm/Hz or dBm/MHz) 3. Channel (2) - relative power (dB) 4. Channel (2) - absolute power (dBm/Hz or dBm/MHz) ... 23. Channel (12) - relative power (dB) 24. Channel (12) - absolute power (dBm/Hz or dBm/MHz) 25. Lower offset A - relative power (dB) 26. Lower offset A - absolute power (dBm/Hz or dBm/MHz) 27. Upper offset A - relative power (dB) 28. Upper offset A - absolute power (dBm/Hz or dBm/MHz) 29. Lower offset B - relative power (dB) 30. Lower offset B - absolute power (dBm/Hz or dBm/MHz) 31. Upper offset B - relative power (dB) 32. Upper offset B - absolute power (dBm/Hz or dBm/MHz) ... 45. Lower offset F - relative power (dB) 46. Lower offset F - absolute power (dBm/Hz or dBm/MHz) 47. Upper offset F - relative power (dB) 48. Upper offset F - absolute power (dBm/Hz or dBm/MHz) <p>If the results are not available, -999.0 is returned.</p>

Condition	n	Results Returned
Mode = DTMB (CTTB) or CMMB, Radio BW = 8MHz and Meas Type = Total power reference	3	Returns 28 scalar values of the pass/fail (0 = passed, or 1 = failed) determined by testing the relative to the reference carrier and by testing the absolute power limit of the offset frequencies (measured as total power in dB): <ol style="list-style-type: none"> 1. Lower offset A - relative limit result 2. Lower offset A - absolute limit result 3. Upper offset A - relative limit result 4. Upper offset A - absolute limit result 5. Lower offset B - relative limit result 6. Lower offset B - absolute limit result 7. Upper offset B - relative limit result 8. Upper offset B - absolute limit result ... 21. Lower offset F - relative limit result 22. Lower offset F - absolute limit result 23. Upper offset F - relative limit result 24. Upper offset F - absolute limit result 25. Inside Adjacent Channel - relative limit result 26. Inside Adjacent Channel - absolute limit result 27. Outside Adjacent Channel - relative limit result 28. Outside Adjacent Channel - absolute limit result If Radio Device = Exciter, the last four (25, 26, 27 and 28) results returned -999.0.

Condition	n	Results Returned
Mode = DTMB (CTTB) or CMMA, Radio BW = 8MHz and Meas Type = Power spectral density reference	3	Returns 28 scalar values of the pass/fail (0 = passed, or 1 = failed) determined by testing the relative to the reference carrier and by testing the absolute power limit of the offset frequencies (measured as power spectral density in dB): 1. Lower offset A - relative limit result 2. Lower offset A - absolute limit result 3. Upper offset A - relative limit result 4. Upper offset A - absolute limit result 5. Lower offset B - relative limit result 6. Lower offset B - absolute limit result 7. Upper offset B - relative limit result 8. Upper offset B - absolute limit result ... 21. Lower offset F - relative limit result 22. Lower offset F - absolute limit result 23. Upper offset F - relative limit result 24. Upper offset F - absolute limit result 25. -999.0 26. -999.0 27. -999.0 28. -999.0 The last four results always returned -999.0.

Condition	n	Results Returned
Meas Type = Total power reference	3	<p>Returns 24 scalar values of the pass/fail (0 = passed, or 1 = failed) determined by testing the relative to the reference carrier and by testing the absolute power limit of the offset frequencies (measured as total power in dB):</p> <ol style="list-style-type: none"> 1. Lower offset A - relative limit result 2. Lower offset A - absolute limit result 3. Upper offset A - relative limit result 4. Upper offset A - absolute limit result 5. Lower offset B - relative limit result 6. Lower offset B - absolute limit result 7. Upper offset B - relative limit result 8. Upper offset B - absolute limit result ... 21 Lower offset F - relative limit result 22 Lower offset F - absolute limit result 23 Upper offset F - relative limit result 24 Upper offset F - absolute limit result
Meas Type = Power spectral density reference	3	<p>Returns 24 scalar values of the pass/fail (0 = passed, or 1 = failed) determined by testing the relative to the reference carrier and by testing the absolute power limit of the offset frequencies (measured as power spectral density in dB):</p> <ol style="list-style-type: none"> 1. Lower offset A - relative limit result 2. Lower offset A - absolute limit result 3. Upper offset A - relative limit result 4. Upper offset A - absolute limit result 5. Lower offset B - relative limit result 6. Lower offset B - absolute limit result 7. Upper offset B - relative limit result 8. Upper offset B - absolute limit result ... 21 Lower offset F - relative limit result 22 Lower offset F - absolute limit result 23 Upper offset F - relative limit result 24 Upper offset F - absolute limit result
	4	Returns <Num Pts> comma-separated scalar values representing the Y values in Trace 1

Condition	n	Results Returned
	5	Returns <Num Pts> comma-separated scalar values representing the Y values in Trace 2
	6	Returns <Num Pts> comma-separated scalar values representing the Y values in Trace 3

Key Path	Front-panel key
Initial S/W Revision	Prior to A.02.00

AMPTD Y Scale

Accesses a menu of functions that enable you to set the vertical scale parameters. The parameter values are measurement independent, except all Attenuation values and the Internal Preamp selections, which are the same across all measurements.

Key Path	Front-panel key
Initial S/W Revision	Prior to A.02.00

Ref Value

Sets the value for the absolute power reference. However, since the Auto Scaling is defaulted to On, this value is automatically determined by the measurement result. When you set a value manually, Auto Scaling automatically changes to Off.

Key Path	AMPTD Y Scale
Mode	SA, WCDMA, C2K, WIMAX OFDMA, TD-SCDMA, 1xEVDO, DVB-T/H, DTMB (CTTB), ISDB-T, CMMB, LTE, LTETDD
Remote Command	:DISPlay:ACPower:VIEW[1]:WINDow[1]:TRACe:Y[:SCALE]:RLEV el <real> :DISPlay:ACPower:VIEW[1]:WINDow[1]:TRACe:Y[:SCALE]:RLEV el?
Example	DISP:ACP:VIEW:WIND:TRAC:Y:RLEV 100 DISP:ACP:VIEW:WIND:TRAC:Y:RLEV?
Notes	You must be in the mode that includes ACP measurements to use this command. Use :INSTRument:SElect to set the mode.
Couplings	When the Auto Scaling is On, this value is automatically determined by the measurement result. When you set a value manually, Auto Scaling automatically changes to Off.
Preset	All Except CDMA1xEVDO:10.00 dBm CDMA1xEVDO: -10dBm
State Saved	Saved in instrument state.
Min	-250.00 dBm
Max	250.00 dBm
Initial S/W Revision	Prior to A.02.00
Modified at S/W Revision	A.02.00, A.03.00

Attenuation

Accesses a menu of functions that enable you to change attenuation settings. This key has read-back text that describes the total attenuator value.

See AMPTD Y Scale, “Attenuation” on page 910 in the “Common Measurement Functions” section for more information.

Key Path	AMPTD Y Scale
Initial S/W Revision	Prior to A.02.00

Scale/Div

Sets the units-per-division of the vertical scale in the logarithmic display. However, since the Auto Scaling is defaulted to On, this value is automatically determined by the measurement result. When you set a value manually, Auto Scaling automatically changes to Off.

Key Path	AMPTD Y Scale
Mode	SA, WCDMA, C2K, WIMAX OFDMA, TD-SCDMA, 1xEVDO, DVB-T/H, DTMB (CTTB), ISDB-T, CMMB, LTE, LTETDD
Remote Command	:DISPlay:ACPower:VIEW[1]:WINDow[1]:TRACe:Y[:SCALe]:PDIVision <rel_ampl> :DISPlay:ACPower:VIEW[1]:WINDow[1]:TRACe:Y[:SCALe]:PDIVision?
Example	DISP:ACP:VIEW:WIND:TRAC:Y:PDIV 5 DISP:ACP:VIEW:WIND:TRAC:Y:PDIV?
Notes	You must be in the mode that includes ACP measurements to use this command. Use :INSTRument:SELect to set the mode.
Couplings	When the Auto Scaling is On, this value is automatically determined by the measurement result. When you set a value manually, Auto Scaling automatically changes to Off.
Preset	10.00 dB
State Saved	Saved in instrument state.
Min	0.10 dB
Max	20.00 dB
Initial S/W Revision	Prior to A.02.00
Modified at S/W Revision	A.02.00, A.03.00

Presel Center

When this key is pressed, the centering of the preselector filter is adjusted to optimize the amplitude

ACP Measurement

AMPTD Y Scale

accuracy at the frequency of the selected marker.

See AMPTD Y Scale, “[Presel Center](#)” on page 926 in the “Common Measurement Functions” section for more information.

Presel Adjust

Allows you to manually adjust the preselector filter frequency to optimize its response to the signal of interest.

See AMPTD Y Scale, “[Preselector Adjust](#)” on page 927 in the “Common Measurement Functions” section for more information.

Y Axis Unit

Allows you to change the vertical (Y) axis amplitude unit.

See “[Y Axis Unit](#)” on page 929 under AMPTD Y Scale in the "Common Measurement Functions" section for more information.

Parameter Name	Y Axis Unit
Key Path	AMPTD Y Scale
Initial S/W Revision	A.04.00

Reference Level Offset

Adds an offset value to the displayed reference level. The reference level is the absolute amplitude represented by the top graticule line on the display.

See “[Reference Level Offset](#)” on page 934 under AMPTD Y Scale in the "Common Measurement Functions" section for more information.

Parameter Name	Reference Level Offset
Key Path	AMPTD Y Scale
Initial S/W Revision	A.04.00

μ W Path Control

The **μ W Path Control** functions include the **μ W Preselector Bypass** (Option MPB) and **Low Noise Path** (Option LNP) controls in the High Band path circuits.

See “ [\$\mu\$ W Path Control](#)” on page 935 under AMPTD Y Scale in the "Common Measurement Functions" section for more information.

Parameter Name	μ W Path Control
Key Path	AMPTD Y Scale
Initial S/W Revision	A.04.00

Internal Preamp

Accesses a menu of functions that enable you to control the internal preamplifiers.

See AMPTD Y Scale, “[Internal Preamp](#)” on page 939 in the “Common Measurement Functions” section for more information.

Key Path	AMPTD Y Scale
Initial S/W Revision	Prior to A.02.00

Ref Position

Positions the reference level at the top, center, or bottom of the Y- scale display. Changing the reference position does not change the reference level value.

Key Path	AMPTD Y Scale
Mode	SA, WCDMA, C2K, WIMAX OFDMA, TD-SCDMA, 1xEVDO, DVB-T/H, DTMB (CTTB), ISDB-T, CMMB, LTE, LTETDD
Remote Command	:DISPlay:ACPowEr:VIEW[1]:WINDow[1]:TRACe:Y[:SCALe]:RPOStion TOP CENTer BOTTom :DISPlay:ACPowEr:VIEW[1]:WINDow[1]:TRACe:Y[:SCALe]:RPOStion?
Example	DISP:ACP:VIEW:WIND:TRAC:Y:RPOS CENT DISP:ACP:VIEW:WIND:TRAC:Y:RPOS?
Notes	You must be in the mode that includes ACP measurements to use this command. Use :INSTrument:SELEct to set the mode.
Preset	TOP
State Saved	Saved in instrument state.
Range	Top Ctr Bot
Initial S/W Revision	Prior to A.02.00
Modified at S/W Revision	A.02.00, A.03.00

Auto Scaling

Toggles the Auto Scaling function between On and Off.

Key Path	AMPTD Y Scale
Mode	SA, WCDMA, C2K, WIMAX OFDMA, TD-SCDMA, 1xEVDO, DVB-T/H, DTMB (CTTB), ISDB-T, CMMB, LTE, LTETDD

ACP Measurement
AMPTD Y Scale

Remote Command	:DISPlay:ACPower:VIEW[1]:WINDow[1]:TRACe:Y[:SCALe]:COUP le 0 1 OFF ON :DISPlay:ACPower:VIEW[1]:WINDow[1]:TRACe:Y[:SCALe]:COUP le?
Example	DISP:ACP:VIEW:WIND:TRAC:Y:COUP ON DISP:ACP:VIEW:WIND:TRAC:Y:COUP?
Notes	You must be in the mode that includes ACP measurements to use this command. Use :INSTrument:SELEct to set the mode.
Couplings	When Auto Scaling is On and the Restart front-panel key is pressed, this function automatically determines the scale per division and reference values based on the measurement results. When you set a value to either Scale/Div or Ref Value manually, Auto Scaling automatically changes to Off.
Preset	ON
State Saved	Saved in instrument state.
Range	On Off
Initial S/W Revision	Prior to A.02.00
Modified at S/W Revision	A.02.00, A.03.00

Auto Couple

See [“Auto Couple” on page 943](#) in the section "Common Measurement Functions" for more information.

BW

Accesses a menu of functions that enable you to specify and control the video and resolution bandwidths. You can also select the type of filter for the measurement and set the filter bandwidth.

Key Path	Front-panel key
Initial S/W Revision	Prior to A.02.00

Res BW

Sets the value of the resolution bandwidth. If an unavailable bandwidth is entered with the numeric keypad, the closest available bandwidth is selected.

Key Path	BW
Mode	SA, WCDMA, C2K, WIMAX OFDMA, TD-SCDMA, 1xEVDO, DVB-T/H, DTMB (CTTB), ISDB-T, CMMB, LTE, LTETDD
Remote Command	[:SENSe]:ACPpower:BANDwidth[:RESolution] <bandwidth> [:SENSe]:ACPpower:BANDwidth[:RESolution]? [:SENSe]:ACPpower:BANDwidth[:RESolution]:AUTO ON OFF 1 0 [:SENSe]:ACPpower:BANDwidth[:RESolution]:AUTO?
Example	ACP:BAND 25kHz ACP:BAND? ACP:BAND:AUTO ON ACP:BAND:AUTO?
Notes	This key is available only in IBW mode. This parameter is preset by the Meas Method selection. Preset values are as follows: IBW: 100 kHz IBWR: 27 kHz FAST (WCDMA): 390 kHz You must be in the mode that includes ACP measurements to use this command. Use :INSTrument:SElect to set the mode.
Dependencies	When Meas Method is RBW or FAST, this key is grayed out and disabled. If the key is pressed, an advisory message is generated. If the equivalent remote command is sent, a "Setting conflict" warning is generated.
Couplings	The resolution bandwidth is coupled to the video bandwidth based on the video to resolution bandwidth ratio setting if AUTO is selected.

Preset	SA: 220 kHz WCDMA: 100 kHz WIMAX OFDMA: 100 kHz C2K: Method RBW: grayed out(1.2MHz) Method IBW: 15kHz TD-SCDMA: 30 kHz 1xEVDO: 30 kHz DVB-T/H: 39kHz DTMB (CTTB): 39kHz ISDB-T: 39kHz CMMB: 39kHz LTE: 100 kHz LTETDD: 100 kHz
State Saved	Saved in instrument state.
Min	1 Hz
Max	8 MHz
Backwards Compatibility SCPI	[[:SENSe]:ACPower:BWIDth[:RESolution] [:SENSe]:ACP:SWEep:BWIDth[:RESolution] (PSA W-CDMA, PSA cdma2000)
Initial S/W Revision	Prior to A.02.00
Modified at S/W Revision	A.02.00, A.03.00

Video BW

Changes the analyzer post-detection filter (VBW).

Key Path	BW
Mode	SA, WCDMA, C2K, WIMAX OFDMA, TD-SCDMA, 1xEVDO, DVB-T/H, DTMB (CTTB), ISDB-T, CMMB, LTE, LTETDD
Remote Command	[[:SENSe]:ACPower:BWIDth:VIDeo <freq> [:SENSe]:ACPower:BWIDth:VIDeo? [:SENSe]:ACPower:BWIDth:VIDeo:AUTO OFF ON 0 1 [:SENSe]:ACPower:BWIDth:VIDeo:AUTO?

ACP Measurement
BW

Example	ACP:BAND:VID 1kHz ACP:BAND:VID? ACP:BWID:VID:AUTO ON ACP:BWID:VID:AUTO?
Notes	The values shown in this table reflect the conditions after a Mode Preset.
Dependencies	When Meas Method is RBW or FAST, this key is grayed out and disabled. If the key is pressed, an advisory message is generated. If the equivalent remote command is sent, a "Setting conflict" warning is generated.
Preset	SA: 22 kHz WCDMA, WIMAX OFDMA: 1MHz C2K: Method RBW: grayed out(1.2MHz) Method IBW: 150 kHz TD-SCDMA: 300 kHz 1xEVDO: 300kHz DVB-T/H: 390kHz DTMB (CTTB): 390kHz ISDB-T: 390kHz CMMB: 390kHz LTE: 1MHz LTETDD: 1MHz SA: ON WCDMA:OFF WIMAX OFDMA: OFF TD-SCDMA: OFF DVB-T/H: OFF DTMB (CTTB): OFF CDMA1xEVDO: OFF ISDB-T: OFF CMMB: OFF LTE: ON LTETDD: ON
State Saved	Saved in instrument state.
Min	1 Hz
Max	50 MHz

Backwards Compatibility SCPI	[[:SENSe]:ACPower:BWIDth:VIDeo
Initial S/W Revision	Prior to A.02.00
Modified at S/W Revision	A.02.00, A.03.00

RBW Control

Accesses a menu that enables you to select the filter bandwidth and type.

Key Path	BW
Initial S/W Revision	Prior to A.02.00

Filter Type

Selects the type of bandwidth filter that is used. The choices are Gaussian or Flat top.

Key Path	BW, RBW Control
Mode	SA, WCDMA, C2K, WIMAX OFDMA, TD-SCDMA, 1xEVDO, DVB-T/H, DTMB (CTTB), ISDB-T, CMMB, LTE, LTETDD
Remote Command	[[:SENSe]:ACPower:BA ^N Dwidth:SHA ^P e GAUSSian FLATtop [[:SENSe]:ACPower:BA ^N Dwidth:SHA ^P e?
Example	ACP:BA ^N D:SHA ^P GAUS ACP:BA ^N D:SHA ^P ?
Dependencies	When Meas Method is FAST, this key is grayed out and disabled. If the key is pressed, an advisory message is generated. If the equivalent remote command is sent, a "Setting conflict" warning is generated.
Preset	GAUSSian
State Saved	Saved in instrument state.
Range	Gaussian (Normal) Flattop
Backwards Compatibility SCPI	[[:SENSe]:ACPower:BA ^N Dwidth:SHA ^P e
Initial S/W Revision	Prior to A.02.00
Modified at S/W Revision	A.02.00, A.03.00

Filter BW

Selects a Gaussian filter based on its –3 dB (Normal) bandwidth or its –6 dB bandwidth.

Key Path	BW, RBW Control
Mode	SA, WCDMA, C2K, WIMAX OFDMA, TD-SCDMA, 1xEVDO, DVB-T/H, DTMB (CTTB), ISDB-T, CMMB, LTE, LTETDD

ACP Measurement
BW

Remote Command	[:SENSe] :ACPower:BAWdwidth:TYPE DB3 DB6 [:SENSe] :ACPower:BAWdwidth:TYPE?
Example	ACP:BAWd:TYPE DB3 ACP:BAWd:TYPE?
Dependencies	When Filter Type is Flattop or Meas Method is RBW or FAST, this key is grayed out and disabled. If the key is pressed, an advisory message is generated. If the equivalent remote command is sent, "Setting conflict" warning is generated.
Preset	DB3
State Saved	Saved in instrument state.
Range	-3 dB (Normal) -6 dB
Backwards Compatibility SCPI	[:SENSe]:ACPower:BWIDth:TYPE
Initial S/W Revision	Prior to A.02.00
Modified at S/W Revision	A.02.00, A.03.00

Cont

See “[Cont \(Continuous Measurement/Sweep\)](#)” on page 957 in the section "Common Measurement Functions" for more information.

FREQ Channel

See “[FREQ Channel](#)” on page 959 in the "Common Measurement Functions" section for more information.

Input/Output

See [“Input/Output” on page 969](#) in the "Common Measurement Functions" section for more information.

Marker

Accesses a menu that enables you to select, set up and control the markers for the current measurement.

Key Path	Front-panel key
Initial S/W Revision	Prior to A.02.00

Select Marker

Displays 12 markers available for selection.

Key Path	Marker
Initial S/W Revision	Prior to A.02.00

Marker Type

Sets the marker control mode to **Normal**, **Delta**, **Fixed** or **Off**. All interactions and dependencies detailed under the key description are enforced when the remote command is sent. If the selected marker is **Off**, pressing **Marker** sets it to **Normal** and places it at the center of the screen on the trace determined by the **Marker Trace** rules. At the same time, **Marker X Axis Value** appears on the Active Function area.

The default active function is the active function for the currently selected marker control mode. If the current control mode is **Off**, there is no active function and the active function is turned off.

Key Path	Marker
Mode	SA, WCDMA, C2K, WIMAX OFDMA, TD-SCDMA, 1xEVDO, DVB-T/H, DTMB (CTTB), ISDB-T, CMMB, LTE, LTETDD
Remote Command	:CALCulate:ACPower:MARKer [1] 2 3 4 5 6 7 8 9 10 11 12 :M ODE POSition DELTa OFF :CALCulate:ACPower:MARKer [1] 2 3 4 5 6 7 8 9 10 11 12 :M ODE?
Example	CALC:ACP:MARK2:MODE DELT CALC:ACP:MARK2:MODE?

Notes	<p>If the selected marker is Off, pressing Marker sets it to Normal and places it at the center of the screen on the trace determined by the Marker Trace rules. At the same time, Marker X Axis Value appears on the Active Function area.</p> <p>Default Active Function: the active function for the selected marker's current control mode. If the current control mode is Off, there is no active function and the active function is turned off.</p> <p>Active Function Display: the marker X axis value entered in the active function area will display the marker value to its full entered precision.</p> <p>You must be in the mode that includes ACP measurements to use this command. Use :INSTrument:SElect to set the mode.</p>
Preset	OFF OFF OFF OFF OFF OFF OFF OFF OFF OFF OFF OFF
State Saved	Saved in instrument state.
Range	Normal Delta Off
Initial S/W Revision	Prior to A.02.00
Modified at S/W Revision	A.02.00, A.03.00

Marker X Axis Value (Remote Command only)

Sets the marker X axis value in the current marker X Axis Scale unit. This value has no effect if the control mode is **Off**, but is the SCPI equivalent of entering an X value if the control mode is **Normal**, **Delta** or **Fixed**.

Mode	SA, WCDMA, C2K, WIMAX OFDMA, TD-SCDMA, 1xEVDO, DVB-T/H, DTMB (CTTB), ISDB-T, CMMB, LTE, LTETDD
Remote Command	<pre>:CALCulate:ACPower:MARKer [1] 2 3 4 5 6 7 8 9 10 11 12 : X <freq></pre> <pre>:CALCulate:ACPower:MARKer [1] 2 3 4 5 6 7 8 9 10 11 12 : X ?</pre>
Example	<pre>CALC:ACP:MARK3:X 0</pre> <pre>CALC:ACP:MARK3:X?</pre>
Notes	The query returns the marker's absolute X Axis value if the control mode is Normal , or the offset from the marker's reference marker if the control mode is Delta . If the marker is Off the response is not a number.
Preset	After a preset, all Markers are turned OFF, so Marker X Axis Value query will return a not a number (NAN).
State Saved	No
Min	-9.9E+37
Max	9.9E+37
Initial S/W Revision	Prior to A.02.00

Modified at S/W Revision	A.02.00, A.03.00
--------------------------	------------------

Marker X Axis Position (Remote Command only)

Sets the marker X position in trace points. It has no effect if the control mode is **Off**, but is the SCPI equivalent of entering a value if the control mode is **Normal**, **Delta** or **Fixed**. The entered value is immediately translated into the current X Axis Scale units for setting the value of the marker.

Mode	SA, WCDMA, C2K, WIMAX OFDMA, TD-SCDMA, 1xEVDO, DVB-T/H, DTMB (CTTB), ISDB-T, CMMB, LTE, LTETDD
Remote Command	:CALCulate:ACPower:MARKer [1] 2 3 4 5 6 7 8 9 10 11 12 :X :POSition <real> :CALCulate:ACPower:MARKer [1] 2 3 4 5 6 7 8 9 10 11 12 :X :POSition?
Example	CALC:ACP:MARK10:X:POS 0 CALC:ACP:MARK10:X:POS?
Notes	The query returns the marker's absolute X Axis value in trace points if the control mode is Normal , or the offset from the marker's reference marker in trace points if the control mode is Delta . The value is returned as a real number, not an integer, corresponding to the translation from X Axis Scale units to trace points (see "Fractional Trace Points"). If the marker is Off the response is not a number. When a Marker is turned on, it is placed center of the screen on the trace. Therefore the default value depends on instrument condition, although the Preset/Default is defined as 500 (this value might be expected value when all offset is on).
Preset	After a preset, all Markers are turned OFF, so Marker X Axis Value query will return a not a number (NaN).
State Saved	No
Min	-9.9E+37
Max	9.9E+37
Initial S/W Revision	Prior to A.02.00
Modified at S/W Revision	A.02.00, A.03.00

Marker Y Axis Value (Remote Command only)

Returns the marker Y axis value in the current marker Y axis unit.

Mode	SA, WCDMA, C2K, WIMAX OFDMA, TD-SCDMA, 1xEVDO, DVB-T/H, DTMB (CTTB), ISDB-T, CMMB, LTE, LTETDD
Remote Command	:CALCulate:ACPower:MARKer [1] 2 3 4 5 6 7 8 9 10 11 12 :Y ?

Example	CALC:ACP:MARK11:Y?
Notes	Since the result value is always calculated from acquisition data, the default value is arbitrary. Although the Preset/Default values are defined.
Preset	Result dependent on markers setup and signal source.
State Saved	No
Backwards Compatibility SCPI	:CALCulate:ACPower:MARKer[1] 2 3 4 5 6 7 8 9 10 11 12:FUNCtion:RESult?
Initial S/W Revision	Prior to A.02.00
Modified at S/W Revision	A.02.00, A.03.00

Properties

Accesses the marker properties menu.

Key Path	Marker
Initial S/W Revision	Prior to A.02.00

Select Marker

Displays 12 markers available for selection.

Key Path	Marker
Initial S/W Revision	Prior to A.02.00

Relative To

Selects the desired marker. The selected marker will be relative to its reference marker.

Key Path	Marker, Properties
Mode	SA, WCDMA, C2K, WIMAX OFDMA, TD-SCDMA, 1xEVDO, DVB-T/H, DTMB (CTTB), ISDB-T, CMMB, LTE, LTETDD
Remote Command	:CALCulate:ACPower:MARKer [1] 2 3 4 5 6 7 8 9 10 11 12 :R EFerence <integer> :CALCulate:ACPower:MARKer [1] 2 3 4 5 6 7 8 9 10 11 12 :R EFerence?
Example	CALC:ACP:MARK2:REF 6 CALC:ACP:MARK2:REF?

Notes	<p>A marker cannot be relative to itself so that choice is grayed out, and if sent via remote command, generates error –221: “Settings conflict; marker cannot be relative to itself.”</p> <p>When queried a single value will be returned (the specified marker numbers relative marker).</p> <p>You must be in the mode that includes ACP measurements to use this command. Use :INSTrument:SELEct to set the mode.</p>
Preset	2 3 4 5 6 7 8 9 10 11 12 1
State Saved	Saved in instrument state.
Min	1
Max	12
Initial S/W Revision	Prior to A.02.00
Modified at S/W Revision	A.02.00, A.03.00

Marker Trace

Selects the trace that you want your marker to be placed on. A marker is associated with one and only one trace. This trace is used to determine the placement, result, and X Axis Scale of the marker. All markers have an associated trace, even **Fixed** markers; it is from that trace that they determine their attributes and behaviors, and it is to that trace that they go when they become Normal or Delta markers.

Key Path	Marker, Properties
Mode	SA, WCDMA, C2K, WIMAX OFDMA, TD-SCDMA, 1xEVDO, DVB-T/H, DTMB (CTTB), ISDB-T, CMMB, LTE, LTETDD
Remote Command	<p>:CALCulate:ACPower:MARKer [1] 2 3 4 5 6 7 8 9 10 11 12 :TRACe 1 2 3</p> <p>:CALCulate:ACPower:MARKer [1] 2 3 4 5 6 7 8 9 10 11 12 :TRACe?</p>
Example	<p>CALC:ACP:MARK2:TRAC 2</p> <p>CALC:ACP:MARK2:TRAC?</p>
Notes	<p>If the selected marker is Off, pressing Marker sets it to Normal and places it at the center of the screen on the trace determined by the Marker Trace rules. At the same time, Marker X Axis Value appears on the Active Function area.</p> <p>Default Active Function: the active function for the selected marker’s current control mode. If the current control mode is Off, there is no active function and the active function is turned off.</p> <p>Active Function Display: the marker X axis value entered in the active function area will display the marker value to its full entered precision.</p>
Couplings	<p>This is not affected by Auto Coupling.</p> <p>Sending the remote command causes the addressed marker to become selected.</p>

Preset	All Markers Off
State Saved	Saved in instrument state.
Range	1 2 3
Initial S/W Revision	Prior to A.02.00
Modified at S/W Revision	A.02.00, A.03.00

Couple Markers

When this function is On, moving any marker causes an equal X axis movement of every other marker which is not **Off**. By “equal X axis movement” we mean that we preserve the difference between each marker’s X axis value (in the fundamental x-axis units of the trace that marker is on) and the X axis value of the marker being moved (in the same fundamental x-axis units).

Key Path	Marker
Mode	SA, WCDMA, C2K, WIMAX OFDMA, TD-SCDMA, 1xEVDO, DVB-T/H, DTMB (CTTB), ISDB-T, CMMB, LTE, LTETDD
Remote Command	:CALCulate:ACPower:MARKer:COUple[:STATE] ON OFF 1 0 :CALCulate:ACPower:MARKer:COUple[:STATE] ?
Example	CALC:ACP:MARK:COUP ON
Preset	OFF
State Saved	Saved in instrument state.
Range	On Off
Initial S/W Revision	Prior to A.02.00
Modified at S/W Revision	A.02.00, A.03.00

Marker All Off

Turns all active markers off.

Key Path	Marker
Mode	SA, WCDMA, C2K, WIMAX OFDMA, TD-SCDMA, 1xEVDO, DVB-T/H, DTMB (CTTB), ISDB-T, CMMB, LTE, LTETDD
Remote Command	:CALCulate:ACPower:MARKer:AOFF
Example	CALC:ACP:MARK:AOFF
Initial S/W Revision	Prior to A.02.00
Modified at S/W Revision	A.02.00, A.03.00

Backward Compatibility SCPI Commands

Sets or queries the state of a marker. Setting a marker which is off to the on state or 1 puts it in Normal mode and places it at the center of the screen.

Mode	SA, WCDMA, WIMAX OFDMA, C2K, TD-SCDMA, 1xEVDO, DVB-T/H, DTMB (CTTB), ISDB-T, CMMB, LTE, LTETDD
Remote Command	:CALCulate:ACPower:MARKer [1] 2 3 4 5 6 7 8 9 10 11 12 :S TATe OFF ON 0 1 :CALCulate:ACPower:MARKer [1] 2 3 4 5 6 7 8 9 10 11 12 :S TATe?
Example	CALC:ACP:MARK2:STAT ON CALC:ACP:MARK2:STAT?
Notes	This parameter is also accessed from Marker, Properties, 1 You must be in the mode that includes ACP measurements to use this command. Use :INSTrument:SElect to set the mode.
Preset	OFF OFF OFF OFF OFF OFF OFF OFF OFF OFF OFF OFF
State Saved	Saved in instrument state.
Range	On Off
Initial S/W Revision	Prior to A.02.00
Modified at S/W Revision	A.02.00, A.03.00

Marker Function

There are no 'Marker Functions' supported in the ACP measurement. The front-panel key will display a blank key menu when pressed.

Key Path	Front-panel key
Initial S/W Revision	Prior to A.02.00

Marker To

There is no 'Marker To' functionality supported in the ACP measurement. The front-panel key will display a blank key menu when pressed.

Key Path	Front-panel key
Initial S/W Revision	Prior to A.02.00

Meas

See [“Meas” on page 1083](#) in the "Common Measurement Functions" section for more information.

Meas Setup

Displays the setup menu for the currently selected measurement. The functions included in the measurement setup menu include setting the parameters for the carriers, offsets, bandwidths, measurement methods and types. This menu also allows you to turn noise correction on and off.

Key Path	Front-panel key
Initial S/W Revision	Prior to A.02.00

Average/Hold Number

Specifies the number of measurement averages used to calculate the measurement result. The average will be displayed at the end of each sweep. After the specified number of average counts, the average mode (termination control) setting determines the average action.

Key Path	Meas Setup
Mode	SA, WCDMA, C2K, WIMAX OFDMA, TD-SCDMA, 1xEVDO, DVB-T/H, DTMB (CTTB), ISDB-T, CMMB, LTE, LTETDD
Remote Command	[:SENSe]:ACPpower:AVERage:COUNT <integer> [:SENSe]:ACPpower:AVERage:COUNT? [:SENSe]:ACPpower:AVERage[:STATe] OFF ON 0 1 [:SENSe]:ACPpower:AVERage[:STATe]?
Example	ACP:AVER:COUN 250 ACP:AVER:COUN? ACP:AVER OFF ACP:AVER?
Notes	You must be in the mode that includes ACP measurements to use this command. Use :INSTrument:SELEct to set the mode.
Preset	10 ON
State Saved	Saved in instrument state.
Min	1
Max	1000
Backwards Compatibility SCPI	[:SENSe]:ACPR:AVERage:COUNT [:SENSe]:MCPower:AVERage:COUNT (PSA Power Suite, PSA W-CDMA, PSA cdma2000)
Initial S/W Revision	Prior to A.02.00

Modified at S/W Revision	A.02.00, A.03.00
--------------------------	------------------

Avg Mode

Enables you to set the averaging mode. This determines the averaging action after the specified number of data acquisitions (average count) is reached.

When set to Exponential (Exp) the measurement averaging continues using the specified number of averages to compute each averaged value. The average will be displayed at the end of each sweep.

When set to Repeat, the measurement resets the average counter each time the specified number of averages is reached.

Key Path	Meas Setup
Mode	SA, WCDMA, C2K, WIMAX OFDMA, TD-SCDMA, 1xEVDO, DVB-T/H, DTMB (CTTB), ISDB-T, CMMB, LTE, LTETDD
Remote Command	[:SENSe] :ACPower:AVERage:TCONtrol EXPonential REPEAT [:SENSe] :ACPower:AVERage:TCONtrol?
Example	ACP:AVER:TCON EXP ACP:AVER:TCON?
Notes	You must be in the mode that includes ACP measurements to use this command. Use :INSTrument:SElect to set the mode.
Preset	EXponential
State Saved	Saved in instrument state.
Range	Exp Repeat
Backwards Compatibility SCPI	[:SENSe] :ACPR:AVERage:TCONtrol
Initial S/W Revision	Prior to A.02.00
Modified at S/W Revision	A.02.0, A.03.000

Carrier Setup

Accesses a menu that contains Carriers, Ref Carrier, Ref Car Freq, Ref Car Pwr and Configure Carriers.

Key Path	Meas Setup
Initial S/W Revision	Prior to A.02.00

Carriers

Specifies the number of carriers to be measured.

Key Path	Meas Setup, Carrier Setup, Configure Carriers
----------	---

ACP Measurement
Meas Setup

Mode	SA, WCDMA, C2K, WIMAX OFDMA, 1xEVDO, TD-SCDMA, DVB-T/H, DTMB (CTTB), ISDB-T, CMMB, LTE, LTETDD
Remote Command	[:SENSE] :ACPower:CARRier [1] 2:COUNT <integer> [:SENSE] :ACPower:CARRier [1] 2:COUNT?
Example	ACP:CARR:COUN 1 ACP:CARR:COUN?
Notes	Carrier sub op code. 1 for BTS, 2 for MS. Default is BTS. Note that Carrier sub op code 2 is supported only in Non-SA modes. In the SA mode, Carrier sub op code 1 is used for both BTS and MS. You must be in the mode that includes ACP measurements to use this command. Use :INSTrument:SELEct to set the mode.
Dependencies	When Number of Carriers is 1, Ref Carrier is grayed out.
Couplings	Changing this parameter might affect to the Span. .
Preset	1
State Saved	Saved in instrument state.
Min	1
Max	12
Initial S/W Revision	Prior to A.02.00
Modified at S/W Revision	A.02.00, A.03.00

Ref Carrier

Sets the reference carrier. Relative power measurements are made from the reference carrier.

If set to Auto, the measurement selects the carrier with the highest power as the reference carrier and the Ref Carrier parameter is updated. If a value is entered when Ref Carrier Mode is set to Auto, the mode changes to Man.

If set to Man, the value that you enter for the Ref Carrier is used as the reference carrier.

Key Path	Meas Setup, Carrier Setup
Mode	SA, WCDMA, C2K, WIMAX OFDMA, 1xEVDO, TD-SCDMA, DVB-T/H, DTMB (CTTB), ISDB-T, CMMB, LTE, LTETDD
Remote Command	[:SENSE] :ACPower:CARRier [1] 2:RCARrier <integer> [:SENSE] :ACPower:CARRier [1] 2:RCARrier? [:SENSE] :ACPower:CARRier [1] 2:RCARrier:AUTO OFF ON 0 1 [:SENSE] :ACPower:CARRier [1] 2:RCARrier:AUTO?

Example	ACP:CARR:RCAR 1 ACP:CARR:RCAR? ACP:CARR:RCAR:AUTO OFF ACP:CARR:RCAR:AUTO?
Notes	Carrier sub op code. 1 for BTS, 2 for MS. Default is BTS. Note that Carrier sub op code 2 is supported only in Non-SA modes. In the SA mode, Carrier sub op code 1 is used for both BTS and MS. You must be in the mode that includes ACP measurements to use this command. Use :INSTrument:SElect to set the mode.
Dependencies	If there is only one carrier, this key will be grayed out.
Couplings	If you enter a carrier value that is currently configured as having no power present, that carrier will be changed to having power present. If you enter a ref carrier this parameter will be set to manual.
Preset	Auto determined
State Saved	Saved in instrument state.
Min	1
Max	Number of available carriers
Backwards Compatibility SCPI	[:SENSe]:MCPower:RCARrier[1] 2 (PSA Power Suite)
Initial S/W Revision	Prior to A.02.00
Modified at S/W Revision	A.02.00, A.03.00

Ref Car Freq

Sets the reference carrier frequency.

Key Path	Meas Setup, Carrier Setup
Mode	SA, WCDMA, C2K, WIMAX OFDMA, 1xEVDO, TD-SCDMA, DVB-T/H, DTMB (CTTB), ISDB-T, CMMB, LTE, LTETDD
Remote Command	[:SENSe]:ACPpower:CARRier[1] 2:RCFRrequency <freq> [:SENSe]:ACPpower:CARRier[1] 2:RCFRrequency? [:SENSe]:ACPpower:CARRier[1] 2:RCFRrequency:AUTO OFF ON 0 1 [:SENSe]:ACPpower:CARRier[1] 2:RCFRrequency:AUTO?
Example	ACP:CARR:RCFR 250 MHz ACP:CARR:RCFR? ACP:CARR:RCFR:AUTO OFF ACP:CARR:RCFR:AUTO?

ACP Measurement
Meas Setup

Notes	<p>Carrier sub op code. 1 for BTS, 2 for MS. Default is BTS.</p> <p>Note that Carrier sub op code 2 is supported only in Non-SA modes.</p> <p>In the SA mode, Carrier sub op code 1 is used for both BTS and MS.</p> <p>You must be in the mode that includes ACP measurements to use this command. Use :INSTrument:SELEct to set the mode.</p>
Couplings	<p>Coupled to the Center Frequency.</p> <p>If the center frequency changes, the Ref Carrier Frequency is calculated using the following three steps;</p> <p>Ref Freq1 = Ctr Freq - (Total of all Carrier Widths / 2)</p> <p>Ref Freq2 = Ref Freq1 + (Total of all Carrier Widths up to Ref Carrier)</p> <p>Ref Freq = Ref Freq2 + (0.5 * Carrier Width of Ref Carrier)</p> <p>If reference carrier frequency changes the Center Frequency is calculated using the following three steps;</p> <p>Ctr Freq1 = Ref Freq - (0.5 * Carrier Width of Ref Carrier)</p> <p>Ctr Freq2 = Ctr Freq1 - (Total of all Carrier Widths up to Ref Carrier)</p> <p>Ctr Freq = Ctr Freq2 + (Total of all Carrier Widths / 2)</p> <p>This ensures that the carriers are always centered on the screen.</p> <p>If there is only one carrier present the Reference Carrier Frequency will be the same as the Center Frequency.</p>
Preset	Calculated based on the current Center Frequency
State Saved	Saved in instrument state.
Min	-79.999995 MHz
Max	<p>Hardware Dependent:</p> <p>Option 503 = 3.699999995 GHz</p> <p>Option 508 = 8.499999995 GHz</p> <p>Option 513 = 13.799999995 GHz</p> <p>Option 526 = 26.999999995 GHz</p>
Initial S/W Revision	Prior to A.02.00
Modified at S/W Revision	A.02.00, A.03.00

Power Ref

Sets the power reference in the carrier that will be used to compute the relative values for the offsets.

Key Path	Meas Setup, Carrier Setup
Initial S/W Revision	Prior to A.02.00
Modified at S/W Revision	A.03.00, A.04.00

Total Power

Sets the multi-carrier power reference.

When set to Auto, the carrier power result reflects the measured power value in the selected reference carrier .

When set to Man, the result is referenced to the last measured value, or you may specify the reference for the multi-carrier power measurement. Relative values are displayed, referenced to the “Power Reference” value.

Key Path	Meas Setup, Carrier Setup, Power Ref
Mode	SA, WCDMA, C2K, WIMAX OFDMA, TD-SCDMA, DVB-T/H, DTMB (CTTB), ISDB-T, CMMB, LTE, LTETDD
Remote Command	[:SENSE] :ACPpower:CARRier [1] 2 [:POWER] <real> [:SENSE] :ACPpower:CARRier [1] 2 [:POWER] ? [:SENSE] :ACPpower:CARRier [1] 2 :AUTO [:STATE] OFF ON 0 1 [:SENSE] :ACPpower:CARRier [1] 2 :AUTO [:STATE] ?
Example	ACP:CARR 10 ACP:CARR? ACP:CARR:AUTO OFF ACP:CARR:AUTO?
Notes	Although the default value is defined, the value is recalculated by the measurement result just after measurement. Carrier sub op code. 1 for BTS, 2 for MS. Default is BTS. Note that Carrier sub op code 2 is supported only in Non-SA modes. In the SA mode, Carrier sub op code 1 is used for both BTS and MS. You must be in the mode that includes ACP measurements to use this command. Use :INSTrument:SElect to set the mode.
Dependencies	This key is available only when the Meas Type is TPreF. If the Meas Type is not TPreF, this key is grayed out.
Preset	0.0 ON
State Saved	Saved in instrument state.
Min	-200 dBm
Max	200 dBm
Backwards Compatibility SCPI	[:SENSe] :MCPower:CARRier [1] 2 [:POWER]
Initial S/W Revision	Prior to A.02.00
Modified at S/W Revision	A.02.00, A.03.00, A.04.00

PSD

Sets the power spectral density in the carrier (main channel) that is used to compute the relative power spectral density values for the offsets when Meas Type is set to PSD Ref. When the PSD Ref state is set to Auto, this will be set to the measured carrier power spectral density.

Key Path	Meas Setup, Carrier Setup, Power Ref
Mode	SA, WCDMA, C2K, WIMAX OFDMA, TD-SCDMA, DVB-T/H, DTMB (CTTB), ISDB-T, CMMB, LTE, LTETDD
Remote Command	[:SENSe] :ACPower:CARRier [1] 2:CPSD <real> [:SENSe] :ACPower:CARRier [1] 2:CPSD?
Example	ACP:CARR:CPSD 25 ACP:CARR:CPSD?
Notes	Although the default value is defined, the value is recalculated by the measurement result just after measurement. Carrier sub op code. 1 for BTS, 2 for MS. Default is BTS. Note that Carrier sub op code 2 is supported only in Non-SA modes. In the SA mode, Carrier sub op code 1 is used for both BTS and MS. You must be in the mode that includes ACP measurements to use this command. Use :INSTrument:SElect to set the mode.
Dependencies	This key is available only when the Meas Type is PSDRef. If the Meas Type is not PSDRef, this key is grayed out.
Couplings	The value of PSD is automatically converted when PSD Unit is changed.
Preset	0.0
State Saved	Saved in instrument state.
Min	-999
Max	999
Initial S/W Revision	Prior to A.02.00
Modified at S/W Revision	A.02.00, A.03.00, A.04.00

Configure Carriers

Accesses a menu that contains Carrier, Carrier Pwr Present, Carrier Width and Carrier Integ BW parameters.

Key Path	Meas Setup, Carrier Setup
Initial S/W Revision	Prior to A.02.00

Carrier

Selects the carrier to configure for the current measurement.

Key Path	Meas Setup, Carrier Setup, Configure Carriers
Mode	SA, WCDMA, C2K, WIMAX OFDMA, 1xEVDO, TD-SCDMA, DVB-T/H, DTMB (CTTB), ISDB-T, CMMB, LTE, LTETDD
Couplings	Max value is the number of available carriers, so this value might change when the number of carriers is changed.
Preset	1
State Saved	No
Min	1
Max	Number of available carriers
Initial S/W Revision	Prior to A.02.00
Modified at S/W Revision	A.02.00, A.03.00

Carrier Coupling

Couples carrier settings to carrier #1. The coupled parameters are Carrier Power Present, Carrier Spacing, Measurement Noise Bandwidth, Method and Filter Alpha.

Key Path	Meas Setup, Carrier Setup, Configure Carriers
Mode	SA, WCDMA, C2K, WIMAX OFDMA, 1xEVDO, TD-SCDMA, DVB-T/H, DTMB (CTTB), ISDB-T, CMMB, LTE, LTETDD
Remote Command	[:SENSe] :ACPower:CARRier [1] 2:LIST:COUPle OFF ON 0 1, ... [:SENSe] :ACPower:CARRier [1] 2:LIST:COUPle?
Example	ACP:CARR:LIST:COUP OFF ACP:CARR:LIST:COUP?
Notes	Carrier sub op code. 1 for BTS, 2 for MS. Default is BTS. Note that Carrier sub op code 2 is supported only in Non-SA modes. In the SA mode, Carrier sub op code 1 is used for both BTS and MS. You must be in the mode that includes ACP measurements to use this command. Use :INSTRument:SElect to set the mode.
Couplings	When Couple is selected, the carrier settings are coupled to carrier #1. Coupled parameters are Carrier Power Present, Carrier Spacing, Measurement Noise Bandwidth, Method and Filter Alpha. When a setting is changed, the couple is set to Man automatically. Carrier #1 is always set to couple and cannot be changed. Couple/Man selection on the Carrier key is not displayed when selected carrier number is #1.

Preset	ON
State Saved	Saved in instrument state.
Range	Couple Man
Initial S/W Revision	Prior to A.02.00
Modified at S/W Revision	A.02.00, A.03.00

Carrier Pwr Present

Configures the carriers for this measurement. It allows spaces to be inserted between carriers. Carriers with the power present parameter set to Yes are carriers, and those with the power present parameter set to No are spaces. Each carrier power present is set to Yes or No. The individual carriers can be set by selecting the desired carrier on the carrier menu key using the up down arrows, the knob, or numeric keypad, then toggling the carrier power present using the carrier power present menu key.

The query for this parameter returns the current values for all of the carriers. If a carrier is defined as having no power present, the power displayed will be relative to the reference carrier, otherwise the absolute power will be displayed.

If you change the carrier power present to no and that carrier is currently configured as the reference carrier, the next carrier to the left (or the right if there are no carriers to the left) will be assigned as the reference carrier. This also applies to the scenario where there are only two carriers configured as having power present and you configure only one carrier to have no power present.

Key Path	Meas Setup, Carrier Setup, Configure Carriers
Mode	SA, WCDMA, C2K, WIMAX OFDMA, 1xEVDO, TD-SCDMA, DVB-T/H, DTMB (CTTB), ISDB-T, CMMB, LTE, LTETDD
Remote Command	[:SENSE] :ACPpower:CARRIER [1] 2:LIST:PPresent YES NO, ... [:SENSE] :ACPpower:CARRIER [1] 2:LIST:PPresent?
Example	ACP:CARR2:LIST:PPR YES ACP:CARR2:LIST:PPR?
Notes	Carrier sub op code. 1 for BTS, 2 for MS. Default is BTS. Note that Carrier sub op code 2 is supported only in Non-SA modes. In the SA mode, Carrier sub op code 1 is used for both BTS and MS. When setting these values remotely, the position in the list sent corresponds to the carrier. Missing values are not permitted, therefore if you want to change values 2 and 6 you must send all values up to 6. Subsequent values will remain unchanged, unless the number of values sent is greater than the number of carriers, then subsequent values will be ignored.
Dependencies	If there is only one carrier, this key will be grayed out.
Couplings	Coupled to the number of carriers. When the remote command is sent, the number of carriers will be set to the number of entries in the parameter list.
Preset	YES

State Saved	Saved in instrument state.
Range	Yes No
Backwards Compatibility SCPI	[[:SENSE]:MCPower:CARRIER[1]]2:LIST:PPresent (PSA Power Suite)
Initial S/W Revision	Prior to A.02.00
Modified at S/W Revision	A.02.00, A.03.00

Carrier Spacing

Sets the width of the carrier spacing. This will be the value applied to all the current slots, whether they are carriers or spaces.

Enter each carrier spacing value individually by selecting the desired carrier on the carrier menu key using the up down arrows, the knob, or the numeric keypad, then enter the carrier width using the carrier spacing menu key.

Key Path	Meas Setup, Carrier Setup, Configure Carriers
Mode	SA, WCDMA, C2K, WIMAX OFDMA, 1xEVDO, TD-SCDMA, DVB-T/H, DTMB (CTTB), ISDB-T, CMMB, LTE, LTETDD
Remote Command	[[:SENSE]:ACPower:CARRIER[1]]2:LIST:WIDTH <bandwidth>, ... [[:SENSE]:ACPower:CARRIER[1]]2:LIST:WIDTH?
Example	ACP:CARR2:LIST:WIDT 25kHz ACP:CARR2:LIST:WIDT?
Notes	Carrier sub op code. 1 for BTS, 2 for MS. Default is BTS. Note that Carrier sub op code 2 is supported only in Non-SA modes. In the SA mode, Carrier sub op code 1 is used for both BTS and MS. When setting these values remotely, the position in the list sent corresponds to the carrier. Missing values are not permitted, therefore if you want to change values 2 and 6 you must send all values up to 6. Subsequent values will remain unchanged, unless the number of values sent is greater than the number of carriers, then subsequent values will be ignored. You must be in the mode that includes ACP measurements to use this command. Use :INSTrument:SELEct to set the mode.
Couplings	Coupled to the number of carriers. When the remote command is sent, the number of carriers will be set to the number of entries in the parameter list. Changing Carrier Spacing might affect the Span.

ACP Measurement
Meas Setup

Preset	SA, WCDMA: 5 MHz WIMAX OFDMA: 10MHz C2K: 1.25MHz 1xEVDO: 1.25MHz TD-SCDMA: 1.6MHz DVB-T/H: 8MHz DTMB (CTTB): 8MHz ISDB-T: 6MHz CMMB: 8MHz LTE: 5 MHz LTETDD: 5 MHz
State Saved	Saved in instrument state.
Min	0 Hz
Max	1 GHz
Backwards Compatibility SCPI	[:SENSe]:MCPower:CARRier[1] 2:LIST:WIDTh (PSA Power Suite)
Initial S/W Revision	Prior to A.02.00
Modified at S/W Revision	A.02.00, A.03.00

Measurement Noise Bandwidth

Specifies the Measurement Noise Bandwidth used to calculate the power in the carriers.

Each Measurement Noise Bandwidth value is entered individually by selecting the desired carrier on the carrier menu key using the up down arrows, the knob, or the numeric keypad. Then enter the measurement noise bandwidth using the measurement noise bandwidth softkey.

Key Path	Meas Setup, Carrier Setup, Configure Carriers
Mode	SA, WCDMA, C2K, WIMAX OFDMA, TD-SCDMA, 1xEVDO, DVB-T/H, DTMB (CTTB), ISDB-T, CMMB, LTE, LTETDD
Remote Command	[:SENSe]:ACPpower:CARRier[1] 2:LIST:BANDwidth[:INTEGRati on] <freq>, ... [:SENSe]:ACPpower:CARRier[1] 2:LIST:BANDwidth[:INTEGRati on]?
Example	ACP:CARR2:LIST:BAND 25kHz ACP:CARR2:LIST:BAND?

Notes	<p>In the WCDMA mode, the preset/default value is defined as 3.84 MHz. But internally, 4.6848 MHz is used as the default value.</p> <p>Carrier sub op code. 1 for BTS, 2 for MS. Default is BTS.</p> <p>Note that Carrier sub op code 2 is supported only in Non-SA modes.</p> <p>In the SA mode, Carrier sub op code 1 is used for both BTS and MS.</p> <p>When setting these values remotely, the position in the list sent corresponds to the carrier. Missing values are not permitted, therefore if you want to change values 2 and 6 you must send all values up to 6. Subsequent values will remain unchanged, unless the number of values sent is greater than the number of carriers, then subsequent values will be ignored.</p> <p>You must be in the mode that includes ACP measurements to use this command. Use :INSTrument:SELEct to set the mode.</p>
Couplings	Coupled to the number of carriers. When the remote command is sent, the number of carriers is set to the number of entries in the parameter list.
Preset	<p>SA: 2 MHz</p> <p>WCDMA: 3.84 MHz</p> <p>WIMAX OFDMA: 10MHz</p> <p>C2K: 1.23MHz</p> <p>TD-SCDMA: 1.28MHz</p> <p>1xEVDO: 1.23MHz</p> <p>DVB-T/H: 7.61MHz</p> <p>DTMB (CTTB): 7.56MHz</p> <p>ISDB-T: 5.6MHz</p> <p>CMMB: 7.512MHz</p> <p>LTE, LTETDD: 4.515 MHz 4.5MHz</p>
State Saved	Saved in instrument state.
Min	10 Hz
Max	1 GHz
Backwards Compatibility SCPI	<p>[:SENSe]:ACPower:BANDwidth:INTEgration</p> <p>[:SENSe]:ACPower:BWIDth:INTEgration</p> <p>[:SENSe]:ACPower:CARRier[1] 2:LIST:BWIDth[:INTEgration]</p> <p>[:SENSe]:MCPower:CARRier[1] 2:LIST:BANDwidth[:INTEgration] (PSA Power Suite)</p> <p>[:SENSe]:MCPower:CARRier[1] 2:LIST:BWIDth[:INTEgration] (PSA Power Suite)</p>
Initial S/W Revision	Prior to A.02.00
Modified at S/W Revision	A.02.00, A.03.00

Method for Carrier

Accesses the carrier configuration method settings.

Key Path	Meas Setup, Carrier Setup, Configure Carriers
Mode	SA, WCDMA, WIMAX OFDMA, TD-SCDMA, DVB-T/H, DTMB (CTTB), ISDB-T, CMMB, LTE, LTETDD
Remote Command	[:SENSE] :ACPpower:CARRier [1] 2 :LIST:FILTer [:RRC] [:STATe] ON OFF 1 0, ... [:SENSE] :ACPpower:CARRier [1] 2 :LIST:FILTer [:RRC] [:STATe] ?
Example	ACP:CARR:LIST:FILT 0,0,0,0 ACP:CARR:LIST:FILT?
Notes	The binary values translate as follows: 1 ON = RRC Weighted 0 OFF = Integ BW Maximum of Array length depends on the number of carriers. You must be in the mode that includes ACP measurements to use this command. Use :INSTRument:SElect to set the mode.
Preset	SA, LTE, LTETDD: OFF WCDMA: ON WIMAX OFDMA: OFF TD-SCDMA: ON DVB-T/H: OFF DTMB (CTTB): ON ISDB-T, CMMB: OFF
State Saved	Saved in instrument state.
Range	IntegBW RRC Weight
Initial S/W Revision	Prior to A.02.00
Modified at S/W Revision	A.02.00, A.03.00

Filter Alpha for Carrier

Inputs the alpha value for the filter used in the current carrier configuration.

Key Path	Meas Setup, Carrier Setup, Configure Carriers, Method, RRC Weighted
Mode	SA, WCDMA, WIMAX OFDMA, TD-SCDMA, DVB-T/H, DTMB (CTTB), ISDB-T, CMMB, LTE, LTETDD

Remote Command	[:SENSe] :ACPower:CARRier [1] 2:LIST:FILTer:ALPHa <real>, ... [:SENSe] :ACPower:CARRier [1] 2:LIST:FILTer:ALPHa?
Example	ACP:CARR2:LIST:FILT:ALPH 0.5 ACP:CARR2:LIST:FILT:ALPH?
Notes	You must be in the mode that includes ACP measurements to use this command. Use :INSTrument:SELEct to set the mode.
Preset	0.22 C2K: No DTMB (CTTB): 0.05
State Saved	Saved in instrument state.
Min	0.01
Max	1.0
Initial S/W Revision	Prior to A.02.00
Modified at S/W Revision	A.02.00, A.03.00

Offset/Limits

Accesses a menu of functions that contains Offset, Offset Freq/Offset To Edge, Offset Integ BW, Upper Offset Limit and Lower Offset parameters.

Key Path	Meas Setup
Initial S/W Revision	Prior to A.02.00

Select Offset

Selects the offset to configure.

Key Path	Meas Setup, Offset/Limits, Limits
Mode	SA, WCDMA, C2K, WIMAX OFDMA, TD-SCDMA, 1xEVDO, DVB-T/H, DTMB (CTTB), ISDB-T, CMMB, LTE, LTETDD
Preset	A
State Saved	Saved in instrument state.
Range	Offset A Offset B Offset C Offset D Offset E Offset F
Initial S/W Revision	Prior to A.02.00
Modified at S/W Revision	A.02.00, A.03.00

Offset Freq

This parameter determines the frequency difference between the center of the main channel and the center of the carrier.

Each Offset Freq state value is entered individually by selecting the desired carrier on the carrier menu key using the up down arrows, RPG or numeric keypad. Then enter the Offset Freq State using the Offset Frequency softkey.

The list contains up to six (6) entries, depending on the mode selected, for offset frequencies. Each offset frequency in the list corresponds to a reference bandwidth in the bandwidth list.

An offset frequency of zero turns the display of the measurement for that offset off, but the measurement is still made and reported. You can turn off (not use) specific offsets with the `[:SENSe]:ACP:OFFSet:LIST:STATe` command

Turning the offset off has the same effect as setting the frequency of the offset to 0 Hz and will cause it to be removed from the results screen.

Key Path	Meas Setup, Offset/Limits
Mode	SA, WCDMA, C2K, WIMAX OFDMA, TD-SCDMA, 1xEVDO, DVB-T/H, DTMB (CTTB), ISDB-T, CMMB, LTE, LTETDD
Remote Command	<pre>[:SENSe]:ACP:Power:OFFSet [1] 2:LIST[:FREQUency] <freq>, <freq>, <freq>, <freq>, <freq></pre> <pre>[:SENSe]:ACP:Power:OFFSet [1] 2:LIST[:FREQUency] ?</pre> <pre>[:SENSe]:ACP:Power:OFFSet [1] 2:LIST:STATe OFF ON 0 1, OFF ON 0 1, OFF ON 0 1, OFF ON 0 1, OFF ON 0 1, OFF ON 0 1</pre> <pre>[:SENSe]:ACP:Power:OFFSet [1] 2:LIST:STATe?</pre>
Example	<pre>ACP:OFFS1:LIST 0,0,0,0,0,0</pre> <pre>ACP:OFFS1:LIST?</pre> <pre>ACP:OFFS2:LIST:STAT 1,1,0,0,0,0</pre> <pre>ACP:OFFS2:LIST:STAT?</pre>
Notes	<p>The label for this menu key will change depending on the currently selected radio standard or mode. For cdma2000 the label for the menu key will be Offset to Edge. For all other supported standards the label will be Offset Freq.</p> <p>When setting these values remotely, the position in the list sent corresponds to the offset. Missing values are not permitted, unless the number of values sent is greater than the number of carriers, then subsequent values will be ignored.</p> <p>Offset sub op code. 1 for BTS, 2 for MS. Default is BTS.</p> <p>Note that Offset sub op code 2 is supported only in Non-SA modes.</p> <p>In the SA mode, Offset sub op code 1 is used for both BTS and MS.</p> <p>You must be in the mode that includes ACP measurements to use this command. Use <code>:INSTRument:SELEct</code> to set the mode.</p>

Couplings	Changing Offset Frequency might affect the Span. See the Span key section for details.
Preset	<p>SA: 3 MHz, 0 Hz, 0 Hz, 0 Hz, 0 Hz, 0 Hz 3 MHz, 0 Hz, 0 Hz, 0 Hz, 0 Hz, 0 Hz</p> <p>WCDMA: 5.0 MHz, 10.0 MHz, 0 Hz, 0 Hz, 0 Hz, 0 Hz 5.0 MHz, 10.0 MHz, 0 Hz, 0 Hz, 0 Hz, 0 Hz</p> <p>WIMAX OFDMA: 10MHz, 20MHz, 0Hz, 0Hz, 0Hz, 0Hz 10MHz, 20MHz, 0Hz, 0Hz, 0Hz, 0Hz</p> <p>C2K:750KHz, 1.980MHz, 0Hz, 0Hz, 0Hz, 0Hz 885KHz, 1.980MHz, 0Hz, 0Hz, 0Hz, 0Hz</p> <p>TD-SCDMA: 1.6 MHz, 3.2 MHz, 0 Hz, 0 Hz, 0 Hz, 0 Hz 1.6 MHz, 3.2 MHz, 0 Hz, 0 Hz, 0 Hz, 0 Hz</p> <p>1xEVDO: 765KHz, 1.995MHz, 3.125MHz, 4.000MHz, 7.500MHz, 7.500MHz 765KHz, 1.995MHz, 3.125MHz, 4.000MHz, 7.500MHz, 7.500MHz</p> <p>DVB-T/H: 8MHz, 16MHz, 0Hz, 0Hz, 0Hz, 0Hz 8MHz, 16MHz, 0Hz, 0Hz, 0Hz, 0Hz</p> <p>DTMB (CTTB): 8MHz, 16MHz, 24MHz, 32MHz, 0Hz, 0Hz 8MHz, 16MHz, 24MHz, 32MHz, 0Hz, 0Hz</p> <p>ISDB-T: 6MHz, 12MHz, 0Hz, 0Hz, 0Hz, 0Hz 6MHz, 12MHz, 0Hz, 0Hz, 0Hz, 0Hz</p> <p>CMMB: 8MHz, 16MHz, 24MHz, 32MHz, 0Hz, 0Hz 8MHz, 16MHz, 24MHz, 32MHz, 0Hz, 0Hz</p> <p>LTE, LTETDD: 5 MHz,10MHz,0,0,0,0 5 MHz,10MHz,0,0,0,0</p> <p>SA: ON, OFF, OFF, OFF, OFF, OFF ON, OFF, OFF, OFF, OFF, OFF</p> <p>WCDMA: ON, ON, OFF, OFF, OFF, OFF ON, ON, OFF, OFF, OFF, OFF</p> <p>WIMAX OFDMA: ON, ON, OFF, OFF, OFF, OFF ON, ON, OFF, OFF, OFF, OFF</p> <p>TD-SCDMA: ON, ON, OFF, OFF, OFF, OFF ON, ON, OFF, OFF, OFF, OFF</p> <p>DVB-T/H: ON, ON, OFF, OFF, OFF, OFF ON, ON, OFF, OFF, OFF, OFF</p> <p>DTMB (CTTB): ON, ON, OFF, OFF, OFF, OFF ON, ON, OFF, OFF, OFF, OFF</p> <p>CDMA1xEVDO: ON,ON,OFF,OFF,OFF,OFF ON,ON,OFF,OFF,OFF,OFF</p> <p>ISDB-T: ON, ON, OFF, OFF, OFF, OFF ON, ON, OFF, OFF, OFF, OFF</p> <p>CMMB: ON, ON, ON, ON, OFF, OFF ON, ON, ON, ON, OFF, OFF</p> <p>LTE, LTETDD: ON, ON, OFF, OFF, OFF, OFF ON, OFF, OFF, OFF, OFF, OFF</p>
State Saved	Saved in instrument state.
Min	0 Hz
Max	500 MHz

ACP Measurement
Meas Setup

Backwards Compatibility SCPI	[[:SENSe]:MCPower:OFFSet[1] 2:LIST[:FREQuency] (PSA Power Suite)
Initial S/W Revision	Prior to A.02.00
Modified at S/W Revision	A.02.00, A.03.00

Integ BW

Sets the Integration Bandwidth for the offsets. If there is more than one bandwidth, the list must contain six (6) entries. Each resolution bandwidth in the list corresponds to an offset frequency in the list defined by [[:SENSe]:ACP:OFFSet[n]:LIST[:FREQuency].

Enter each value individually by selecting the desired offset on the offset menu key using the up down arrows, the knob, or the numeric keypad, then enter the Offset Integration Bandwidth using the Offset Integration Bandwidth menu key.

You can turn off (not use) specific offsets with the [[:SENSe]:ACP:OFFSet[n]:LIST:STATe command."

Key Path	Meas Setup, Offset/Limits
Mode	SA, WCDMA, C2K, WIMAX OFDMA, TD-SCDMA, 1xEVDO, DVB-T/H, DTMB (CTTB), ISDB-T, CMMB, LTE, LTETDD
Remote Command	[[:SENSe]:ACP:OFFSet [1] 2:LIST:BANDwidth[:INTEgratio n] <bandwidth>, <bandwidth>, <bandwidth>, <bandwidth>, <bandwidth>, <bandwidth> [[:SENSe]:ACP:OFFSet [1] 2:LIST:BANDwidth[:INTEgratio n] ?
Example	ACP:OFFS2:LIST:BAND 2MHz,2MHz,2MHz,2MHz,2MHz,2MHz ACP:OFFS2:LIST:BAND?
Notes	When setting these values remotely, the position in the list sent corresponds to the offset. Missing values are not permitted i.e. if you want to change values 2 you must send all values up to 2. Subsequent values will remain unchanged, unless the number of values sent is greater than the number of carriers, then subsequent values will be ignored. Offset sub op code. 1 for BTS, 2 for MS. Default is BTS. Note that Offset sub op code 2 is supported only in Non-SA modes. In the SA mode, Offset sub op code 1 is used for both BTS and MS. You must be in the mode that includes ACP measurements to use this command. Use :INSTRument:SELEct to set the mode.
Couplings	Changing Integ BW might affect to the Span. See Span section for details.

Preset	<p>SA: 2 MHz, 2 MHz, 2 MHz, 2 MHz, 2 MHz, 2 MHz 2 MHz, 2 MHz, 2 MHz, 2 MHz, 2 MHz, 2 MHz</p> <p>WCDMA: 3.84 MHz, 3.84 MHz, 3.84 MHz, 3.84 MHz, 3.84 MHz, 3.84 MHz 3.84 MHz, 3.84 MHz, 3.84 MHz, 3.84 MHz, 3.84 MHz, 3.84 MHz</p> <p>WIMAX OFDMA: 10MHz, 10MHz, 10MHz, 10MHz, 10MHz, 10MHz 10MHz, 10MHz, 10MHz, 10MHz, 10MHz, 10MHz</p> <p>C2K: 30KHz, 30KHz, 30KHz, 30KHz, 30KHz, 30KHz 30KHz, 30KHz, 30KHz, 30KHz, 30KHz, 30KHz</p> <p>TD-SCDMA: 1.28 MHz, 1.28 MHz, 1.28 MHz, 1.28 MHz, 1.28 MHz, 1.28 MHz</p> <p>1xEVDO: C2K: 30KHz, 30KHz, 30KHz, 30KHz, 30KHz, 30KHz 30KHz, 30KHz, 30KHz, 30KHz, 30KHz, 30KHz</p> <p>DVB-T/H: 7.61MHz, 7.61MHz, 7.61MHz, 7.61MHz, 7.61MHz, 7.61MHz 7.61MHz, 7.61MHz, 7.61MHz, 7.61MHz, 7.61MHz, 7.61MHz</p> <p>DTMB (CTTB): 7.56MHz, 7.56MHz, 7.56MHz, 7.56MHz, 7.56MHz, 7.56MHz 7.56MHz, 7.56MHz, 7.56MHz, 7.56MHz, 7.56MHz, 7.56MHz</p> <p>ISDB-T: 5.6MHz, 5.6MHz, 5.6MHz, 5.6MHz, 5.6MHz, 5.6MHz 5.6MHz, 5.6MHz, 5.6MHz, 5.6MHz, 5.6MHz, 5.6MHz</p> <p>CMMB: 7.512MHz, 7.512MHz, 7.512MHz, 7.512MHz, 7.512MHz, 7.512MHz 7.512MHz, 7.512MHz, 7.512MHz, 7.512MHz, 7.512MHz, 7.512MHz</p> <p>LTE, LTETDD: 4.515 MHz, 4.515 MHz, 4.515 MHz, 4.515 MHz, 4.515 MHz, 4.515 MHz 4.5MHz, 4.5MHz, 4.5MHz, 4.5MHz, 4.5MHz, 4.5MHz</p>
State Saved	Saved in instrument state.
Min	10 Hz
Max	1 GHz
Backwards Compatibility SCPI	<p>[[:SENSe]:ACPower:OFFSet[1]]2:LIST:BWIDth[:INTegration]</p> <p>[[:SENSe]:ACPR:OFFSet[1]]2:LIST:BANDwidth</p> <p>[[:SENSe]:ACPR:OFFSet[1]]2:LIST:BWIDth</p> <p>[[:SENSe]:MCPower:OFFSet[1]]2:LIST:BANDwidth[:INTegration] (PSA Power Suite)</p> <p>[[:SENSe]:MCPower:OFFSet[1]]2:LIST:BWIDth[:INTegration] (PSA Power Suite)</p>
Initial S/W Revision	Prior to A.02.00
Modified at S/W Revision	A.02.00, A.03.00

Offset BW

Accesses the offset bandwidth menu.

Key Path	Meas Setup, Offset/Limits
----------	----------------------------------

ACP Measurement
Meas Setup

Initial S/W Revision	Prior to A.02.00
----------------------	------------------

Res BW

Sets the resolution bandwidth. If an unavailable bandwidth is entered with the numeric keypad, the closest available bandwidth is selected.

Key Path	Meas Setup, Offset/Limits
Mode	SA, WCDMA, C2K, WIMAX OFDMA, TD-SCDMA, 1xEVDO, DVB-T/H, DTMB (CTTB), ISDB-T, CMMB, LTE, LTETDD
Remote Command	<pre>[:SENSe] :ACPower:OFFSet [1] 2:LIST:BANDwidth:RESolution <bandwidth>, <bandwidth>, <bandwidth>, <bandwidth>, <bandwidth>, <bandwidth> [:SENSe] :ACPower:OFFSet [1] 2:LIST:BANDwidth:RESolution? [:SENSe] :ACPower:OFFSet [1] 2:LIST:BANDwidth:RESolution: AUTO ON OFF 1 0, ON OFF 1 0, ON OFF 1 0, ON OFF 1 0, ON OFF 1 0, ON OFF 1 0 [:SENSe] :ACPower:OFFSet [1] 2:LIST:BANDwidth:RESolution: AUTO?</pre>
Example	<pre>ACP:OFFS2:LIST:BAND:RES 220kHz,220kHz,220kHz,220kHz,220kHz,220kHz ACP:OFFS2:LIST:BAND:RES? ACP:OFFS2:LIST:BAND:RES:AUTO 1,1,1,1,1,1 ACP:OFFS2:LIST:BAND:RES:AUTO?</pre>
Notes	<p>This key is available only in the IBW mode.</p> <p>Offset sub op code. 1 for BTS, 2 for MS. Default is BTS.</p> <p>Note that Offset sub op code 2 is supported only in Non-SA modes.</p> <p>In the SA mode, Offset sub op code 1 is used for both BTS and MS.</p> <p>You must be in the mode that includes ACP measurements to use this command. Use :INSTRument:SELEct to set the mode.</p>
Dependencies	When Meas Method is RBW or FAST, this key is grayed out and disabled. If the key is pressed, an advisory message is generated. If the equivalent remote command is sent, a "Setting conflict" warning is generated.
Couplings	When Res BW Mode is AUTO, this value is exactly same as Res BW under BW key. And when this value is changed by user, Res BW Mode is also changed to Man.

Preset	<p>SA: 220 kHz, 220 kHz, 220 kHz, 220 kHz, 220 kHz, 220 kHz</p> <p>WCDMA: 100 kHz, 100 kHz, 100 kHz, 100 kHz, 100 kHz, 100 kHz</p> <p>WIMAX OFDMA: 100KHz, 100KHz, 100KHz, 100KHz, 100KHz, 100KHz</p> <p>C2K:</p> <p>Method:RBW</p> <p>30K</p> <p>Method: IBW</p> <p>C2K: 15KHz, 15KHz, 15KHz, 15KHz,15KHz, 15KHz 15KHz, 15KHz, 15KHz, 15KHz,15KHz, 15KHz</p> <p>TD-SCDMA: 30 kHz, 30 kHz, 30 kHz, 30 kHz, 30 kHz, 30 kHz</p> <p>1xEVDO: 3KHz, 30KHz, 30KHz, 30KHz,30KHz, 30KHz 3KHz, 30KHz, 30KHz, 30KHz,30KHz, 30KHz</p> <p>DVB-T/H: 39KHz, 39KHz, 39KHz, 39KHz,39KHz, 39KHz 39KHz, 39KHz, 39KHz, 39KHz, 39KHz, 39KHz</p> <p>DTMB (CTTB): 39KHz, 39KHz, 39KHz, 39KHz,39KHz, 39KHz 39KHz, 39KHz, 39KHz, 39KHz, 39KHz</p> <p>ISDB-T: 39KHz, 39KHz, 39KHz, 39KHz,39KHz, 39KHz 39KHz, 39KHz, 39KHz, 39KHz, 39KHz, 39KHz</p> <p>CMMB: 39KHz, 39KHz, 39KHz, 39KHz,39KHz, 39KHz 39KHz, 39KHz, 39KHz, 39KHz, 39KHz, 39KHz</p> <p>LTE, LTETDD:</p> <p>100kHz,100kHz,100kHz,100kHz,100kHz,100kHz 100kHz,100kHz,100kHz,100kHz,100kHz,100kHz</p> <p>1, 1, 1, 1, 1, 1</p>
State Saved	Saved in instrument state.
Min	1 Hz
Max	8 MHz
Backwards Compatibility SCPI	[:SENSe]:ACPower:OFFSet[1] 2:LIST:BWIDth:RESolution
Initial S/W Revision	Prior to A.02.00
Modified at S/W Revision	A.02.00, A.03.00

Video BW

Enables you to change the analyzer post-detection filter (VBW).

Key Path	Meas Setup, Offset/Limits, Offset BW
Mode	SA, WCDMA, C2K, WIMAX OFDMA, TD-SCDMA, 1xEVDO, DVB-T/H, DTMB (CTTB), ISDB-T, CMMB, LTE, LTETDD

ACP Measurement
Meas Setup

<p>Remote Command</p>	<pre>[:SENSe] :ACPower:OFFSet [1] 2:LIST:BANDwidth:VIDeo <freq>, <freq>, <freq>, <freq>, <freq>, <freq> [:SENSe] :ACPower:OFFSet [1] 2:LIST:BANDwidth:VIDeo? [:SENSe] :ACPower:OFFSet [1] 2:LIST:BANDwidth:VIDeo:AUTO OFF ON 0 1, OFF ON 0 1, OFF ON 0 1, OFF ON 0 1, OFF ON 0 1, OFF ON 0 1 [:SENSe] :ACPower:OFFSet [1] 2:LIST:BANDwidth:VIDeo:AUTO?</pre>
<p>Example</p>	<pre>ACP:OFFS2:LIST:BAND:VID 5MHz,5MHz,5MHz,5MHz,5MHz,5MHz ACP:OFFS2:LIST:BAND:VID? ACP:OFFS2:LIST:BAND:VID:AUTO 0,0,0,0,1,1 ACP:OFFS2:LIST:BAND:VID:AUTO?</pre>
<p>Notes</p>	<p>The values shown in this table reflect the conditions after a Mode Preset.</p> <p>Offset sub op code. 1 for BTS, 2 for MS. Default is BTS.</p> <p>Note that Offset sub op code 2 is supported only in Non-SA modes.</p> <p>In the SA mode, Offset sub op code 1 is used for both BTS and MS.</p> <p>You must be in the mode that includes ACP measurements to use this command. Use :INSTrument:SElect to set the mode.</p>
<p>Dependencies</p>	<p>When Meas Method is RBW or FAST, this key is grayed out and disabled. If the key is pressed, an advisory message is generated. If the equivalent remote command is sent, "Setting conflict" warning is generated.</p>
<p>Preset</p>	<pre>SA: 22kHz, 22kHz, 22kHz, 22kHz, 22kHz, 22kHz WCDMA, WIMAX OFDMA: 1MHz, 1MHz, 1MHz, 1MHz, 1MHz, 1MHz C2K: 150KHz, 150KHz, 150KHz, 150KHz, 150KHz, 150KHz 150KHz, 150KHz, 150KHz, 150KHz, 150KHz, 150KHz TD-SCDMA: 300kHz, 300kHz, 300kHz, 300kHz, 300kHz, 300kHz 1xEVDO: 30KHz, 300KHz, 300KHz, 300KHz, 300KHz, 300KHz 30KHz, 300KHz, 300KHz, 300KHz, 300KHz DVB-T/H: 390KHz, 390KHz, 390KHz, 390KHz,390KHz, 390KHz 390KHz, 390KHz, 390KHz, 390KHz, 390KHz DTMB (CTTB): 390KHz, 390KHz, 390KHz, 390KHz,390KHz, 390KHz 390KHz, 390KHz, 390KHz, 390KHz, 390KHz, 390KHz ISDB-T: 390KHz, 390KHz, 390KHz, 390KHz,390KHz, 390KHz 390KHz, 390KHz, 390KHz, 390KHz, 390KHz CMMB: 390KHz, 390KHz, 390KHz, 390KHz,390KHz, 390KHz 390KHz, 390KHz, 390KHz, 390KHz, 390KHz LTE, LTETDD: 1MHz,1MHz,1MHz,1MHz,1MHz,1MHz ON, ON, ON, ON, ON, ON</pre>
<p>State Saved</p>	<p>Saved in instrument state.</p>

Min	1 Hz
Max	50 MHz
Backwards Compatibility SCPI	[:SENSe]:ACPower:OFFSet[1] 2:LIST:BWIDth:VIDeo
Initial S/W Revision	Prior to A.02.00
Modified at S/W Revision	A.02.00, A.03.00

RBW Control

Accesses the resolution bandwidth control menu.

Key Path	Meas Setup, Offset/Limits, Offset BW
Initial S/W Revision	Prior to A.02.00

Filter Type

Selects the type of bandwidth filter that is used.

Key Path	Meas Setup, Offset/Limits, Offset BW, RBW Control
Mode	SA, WCDMA, C2K, WIMAX OFDMA, TD-SCDMA, 1xEVDO, DVB-T/H, DTMB (CTTB), ISDB-T, CMMB, LTE, LTETDD
Remote Command	[:SENSe]:ACPower:OFFSet[1] 2:LIST:BANDwidth:SHApe GAUSSian FLATtop, GAUSSian FLATtop, GAUSSian FLATtop, GAUSSian FLATtop, GAUSSian FLATtop, GAUSSian FLATtop [:SENSe]:ACPower:OFFSet[1] 2:LIST:BANDwidth:SHApe?
Example	ACP:OFFS2:LIST:BAND:SHAP FLAT,GAUS,GAUS,GAUS,GAUS,GAUS ACP:OFFS2:LIST:BAND:SHAP?
Notes	Offset sub op code. 1 for BTS, 2 for MS. Default is BTS. Note that Offset sub op code 2 is supported only in Non-SA modes. In the SA mode, Offset sub op code 1 is used for both BTS and MS. You must be in the mode that includes ACP measurements to use this command. Use :INSTrument:SElect to set the mode.
Dependencies	When Res BW Mode for the offset is Auto, this key is grayed out and disabled. Since Res BW Mode for the offset is presetted to Auto on changing Meas Method to RBW or FAST, this key is grayed out and disabled too. If the key is pressed, an advisory message is generated. If the equivalent remote command is sent, a "Setting conflict" warning is generated.
Couplings	See the description above
Preset	GAUSSian, GAUSSian, GAUSSian, GAUSSian, GAUSSian, GAUSSian
State Saved	Saved in instrument state.
Range	GAUSSian FLATtop

ACP Measurement
Meas Setup

Backwards Compatibility SCPI	[:SENSE]:ACPower:OFFSet[1] 2:LIST:BWIDth:SHAPE
Initial S/W Revision	Prior to A.02.00
Modified at S/W Revision	A.02.00, A.03.00

Filter BW

Selects a Gaussian filter based on its -3 dB (Normal) bandwidth or its -6 dB bandwidth.

Key Path	Meas Setup, Offset/Limits, Offset BW, RBW Control
Mode	SA, WCDMA, C2K, WIMAX OFDMA, TD-SCDMA, 1xEVDO, DVB-T/H, DTMB (CTTB), ISDB-T, CMMB, LTE, LTETDD
Remote Command	[:SENSE]:ACPower:OFFSet [1] 2:LIST:BAWdwidth:TYPE DB3 DB6, DB3 DB6, DB3 DB6, DB3 DB6, DB3 DB6, DB3 DB6 [:SENSE]:ACPower:OFFSet [1] 2:LIST:BAWdwidth:TYPE?
Example	ACP:OFFS2:LIST:BAWd:TYPE DB3,DB3,DB3,DB3,DB3,DB3 ACP:OFFS2:LIST:BAWd:TYPE?
Notes	Offset sub op code. 1 for BTS, 2 for MS. Default is BTS. Note that Offset sub op code 2 is supported only in Non-SA modes. In the SA mode, Offset sub op code 1 is used for both BTS and MS. You must be in the mode that includes ACP measurements to use this command. Use :INSTrument:SELEct to set the mode.
Dependencies	When Filter Type if Flattop or Res BW Mode for the offset is Auto, this key is grayed out and disabled. Since Res BW Mode for the offset is presetted to Auto on changing Meas Method to RBW or FAST, this key is grayed out and disabled too. If the key is pressed, an advisory message is generated. If the equivalent remote command is sent, a "Setting conflict" warning is generated.
Preset	DB3, DB3, DB3, DB3, DB3, DB3
State Saved	Saved in instrument state.
Range	-3 dB (Normal) -6 dB
Backwards Compatibility SCPI	[:SENSE]:ACPower:OFFSet[1] 2:LIST:BWIDth:TYPE
Initial S/W Revision	Prior to A.02.00
Modified at S/W Revision	A.02.00, A.03.00

Limits

Limits key accesses a menu of functions that contains Select Offset, Abs Limit, Rel Limit and Fail Mask parameters.

Key Path	Meas Setup, Offset/Limits
Initial S/W Revision	A.03.00

Abs Limit

Enters an absolute limit value, which sets the absolute amplitude levels to test against for each of the custom offsets. The list must contain six (6) entries. If there is more than one offset, the offset closest to the carrier channel is the first one in the list. [:SENSe]:ACP:OFFSet[n]:LIST:TEST selects the type of testing to be done at each offset.

You can turn off (not use) specific offsets with the [:SENSe]:ACP:OFFSet[n]:LIST:STATe command.

The query returns the six (6) sets of real numbers that are the current absolute amplitude test limits.

Key Path	Meas Setup, Offset/Limits, Limits
Mode	SA, WCDMA, C2K, WIMAX OFDMA, TD-SCDMA, 1xEVDO, DVB-T/H, DTMB (CTTB), ISDB-T, CMMB, LTE, LTETDD
Remote Command	[:SENSe]:ACP:OFFSet [1] 2:LIST:ABSolute <real>, <real>, <real>, <real>, <real> [:SENSe]:ACP:OFFSet [1] 2:LIST:ABSolute?
Example	ACP:OFFS2:LIST:ABS -10,-10,-10,-10,-10,-10 ACP:OFFS2:LIST:ABS?
Notes	Offset sub op code. 1 for BTS, 2 for MS. Default is BTS. Note that Offset sub op code 2 is supported only in Non-SA modes. In the SA mode, Offset sub op code 1 is used for both BTS and MS. You must be in the mode that includes ACP measurements to use this command. Use :INSTrument:SElect to set the mode.
Couplings	None If current mode is DTMB (CTTB) or CMMB and current device type is Transmitter, the value from position 2 to position 4 are coupled, changing any one will change the others.

ACP Measurement
Meas Setup

Preset	SA: 0dBm, 0 dBm, 0 dBm, 0 dBm, 0 dBm, 0 dBm 0dBm, 0 dBm, 0 dBm, 0 dBm, 0 dBm, 0 dBm WCDMA: 50 dBm, 50 dBm, 50 dBm, 50 dBm, 50 dBm, 50 dBm 50 dBm, 50 dBm, 50 dBm, 50 dBm, 50 dBm, 50 dBm C2K: 50 dBm, 50 dBm, 50 dBm, 50 dBm, 50 dBm, 50 dBm 50 dBm, 50 dBm, 50 dBm, 50 dBm, 50 dBm, 50 dBm WIMAX OFDMA: 50,50,50,50,50,50 TD-SCDMA: 50 dBm, 50 dBm, 50 dBm, 50 dBm, 50 dBm, 50 dBm 50 dBm, 50 dBm, 50 dBm, 50 dBm, 50 dBm, 50 dBm 1xEVDO: -27dBm, -27dBm, -13dBm, -13dBm, -13dBm, -13dBm -27dBm, -27dBm, -13dBm, -13dBm, -13dBm, -13dBm DVB-T/H: 50 dBm, 50 dBm, 50 dBm, 50 dBm, 50 dBm, 50 dBm 50 dBm, 50 dBm, 50 dBm, 50 dBm, 50 dBm, 50 dBm DTMB (CTTB): 11.14 dBm, 11.14dBm, 11.14 dBm, 11.14 dBm, 50 dBm, 50 dBm 11.14 dBm, 11.14 dBm, 11.14 dBm, 11.14 dBm, 50 dBm, 50 dBm ISDB-T: 50 dBm, 50 dBm, 50 dBm, 50 dBm, 50 dBm, 50 dBm 50 dBm, 50 dBm, 50 dBm, 50 dBm, 50 dBm, 50 dBm CMMB: 11.14 dBm, 11.14dBm, 11.14 dBm, 11.14 dBm, 50 dBm, 50 dBm 11.14 dBm, 11.14 dBm, 11.14 dBm, 11.14 dBm, 50 dBm, 50 dBm LTE, LTETDD: -8.45,-8.45,-8.45,-8.45,-8.45,-8.45 -50.0,-50.0,-50.0,-50.0,-50.0,-50.0
State Saved	Saved in instrument state.
Min	-200.0 dBm
Max	50.0 dBm
Backwards Compatibility SCPI	[[:SENSE]:ACPR:OFFSet[1]]2:LIST:ABSolute (PSA W-CDMA, PSA cdma2000) [:SENSE]:MCPower:OFFSet[1]]2:LIST:ABSolute (PSA W-CDMA)
Initial S/W Revision	Prior to A.02.00
Modified at S/W Revision	A.02.00, A.03.00

Rel Lim (Car)

Enters a relative limit value for the carrier level. This sets the amplitude levels to test against for the specified offsets.

The amplitude level is relative to the carrier amplitude. If multiple offsets are available, the list contains six (6) entries. The offset closest to the carrier channel is the first one in the list.

[[:SENSE]:ACP:OFFSet:LIST:TEST selects the type of testing to be done at each offset.

[[:SENSE]:ACP:OFFSet[n]:LIST[n]:TEST selects the type of testing to be done at each offset.

You can turn off (not use) specific offsets with the [[:SENSE]:ACP:OFFSet[n]:LIST[n]:STATe command.

The query returns the six (6) sets of real numbers that are the current amplitude test limits, relative to the

carrier, for each offset.

Offset[n] n=1 is base station and 2 is mobiles. The default is base station (1).

Key Path	Meas Setup, Offset/Limits, Limits,
Mode	SA, WCDMA, C2K, WIMAX OFDMA, TD-SCDMA, 1xEVDO, DVB-T/H, DTMB (CTTB), ISDB-T, CMMB, LTE, LTETDD
Remote Command	[:SENSe] :ACPower:OFFSet [1] 2:LIST:RCARrier <real>, <real>, <real>, <real>, <real> [:SENSe] :ACPower:OFFSet [1] 2:LIST:RCARrier?
Example	ACP:OFFS2:LIST:RCAR 0,0,0,0,0 ACP:OFFS2:LIST:RCAR?
Notes	Offset sub op code. 1 for BTS, 2 for MS. Default is BTS. Note that Offset sub op code 2 is supported only in Non-SA modes. In the SA mode, Offset sub op code 1 is used for both BTS and MS. You must be in the mode that includes ACP measurements to use this command. Use :INSTrument:SElect to set the mode.
Couplings	None If current mode is DTMB (CTTB) or CMMB and current device type is Transmitter, the value from position 2 to position 4 are coupled, changing any one will change the others.
Preset	SA: -45, -60, 0, 0, 0, 0 -45, -60, 0, 0, 0, 0 WCDMA: -44.2, -49.2, -49.2, -49.2, -49.2, -49.2 -32.2, -42.2, -42.2, -42.2, -42.2, -42.2 C2K: 0, 0, 0, 0, 0, 0 0, 0, 0, 0, 0, 0 WIMAX OFDMA: -50,-60,0,0,0,0 TD-SCDMA: -40, -45, -45, -45, -45, -45 -33, -43, -43, -43, -43, -43 1xEVDO: -45, -55, -55, -55, -55, -55 -45, -55, -55, -55, -55, -55 DVB-T/H: -60, -60, 0, 0, 0, 0 -60, -60, 0, 0, 0, 0 DTMB (CTTB): -45, -60, -60, -60, 50, 50 -45, -60, -60, -60, 50, 50 ISDB-T: -60, -60, 0, 0, 0, 0 -60, -60, 0, 0, 0, 0 CMMB: -45, -60, -60, -60, 50, 50 -45, -60, -60, -60, 50, 50 LTE, LTETDD: -44.2,-44.2,-44.2,-44.2,-44.2,-44.2 -29.2, -29.2, -29.2, -29.2, -29.2, -29.2
State Saved	Saved in instrument state.
Min	-150
Max	50.0
Backwards Compatibility SCPI	[:SENSe] :MCPower:OFFSet[1] 2:LIST:RCARrier (PSA WCDMA)

ACP Measurement
Meas Setup

Initial S/W Revision	Prior to A.02.00
Modified at S/W Revision	A.02.00, A.03.00, A.04.00

Positive Offset Limit

Enables you to set the upper limit for the upper segment of the specified offset pair.

Mode	SA, WCDMA, C2K, WIMAX OFDMA, TD-SCDMA, 1xEVDO, DVB-T/H, DTMB (CTTB), ISDB-T, CMMB, LTE, LTETDD
Remote Command	:CALCulate:ACPpower:OFFSet:LIST:LIMit:POSitive[:UPPer]:DATA <real>, <real>, <real>, <real>, <real>, <real> :CALCulate:ACPpower:OFFSet:LIST:LIMit:POSitive[:UPPer]:DATA?
Example	CALC:ACP:OFFS:LIST:LIM:POS:DATA 0,0,0,0,0 CALC:ACP:OFFS:LIST:LIM:POS:DATA?
Notes	Remote command only.
Preset	SA: -45, -60, 0, 0, 0, 0 -45, -60, 0, 0, 0, 0 WCDMA: -44.2, -49.2, -49.2, -49.2, -49.2, -49.2 -32.2, -42.2, -42.2, -42.2, -42.2, -42.2 C2K: 0, 0, 0, 0, 0, 0 0, 0, 0, 0, 0, 0 WIMAX OFDMA: -50, -60, 0, 0, 0, 0 TD-SCDMA: -40, -45, -45, -45, -45, -45 -33, -43, -43, -43, -43, -43 1xEVDO: -45, -55, -55, -55, -55, -55 -45, -55, -55, -55, -55, -55 DVB-T/H: -60, -60, 0, 0, 0, 0 -60, -60, 0, 0, 0, 0 DTMB (CTTB): -45, -60, -60, -60, 50, 50 -45, -60, -60, -60, 50, 50 ISDB-T: -60, -60, 0, 0, 0, 0 -60, -60, 0, 0, 0, 0 CMMB: -45, -60, -60, -60, 50, 50 -45, -60, -60, -60, 50, 50
State Saved	Saved in instrument state.
Min	-150.0
Max	50.0
Backwards Compatibility SCPI	:CALCulate:MCPower:OFFSet:LIST:LIMit:POSitive[:UPPer]:DATA (PSA Power Suite)
Initial S/W Revision	A.04.00

Negative Offset Limit

Enables you to set the upper limit for the lower segment of the specified offset pair.

Mode	SA, WCDMA, C2K, WIMAX OFDMA, TD-SCDMA, 1xEVDO, DVB-T/H, DTMB (CTTB), CMMB, ISDB-T, LTE, LTETDD
------	--

Remote Command	:CALCulate:ACPower:OFFSet:LIST:LIMit:NEGative[:UPPer]:DATA <real>, <real>, <real>, <real>, <real>, <real> :CALCulate:ACPower:OFFSet:LIST:LIMit:NEGative[:UPPer]:DATA?
Example	CALC:ACP:OFFS:LIST:LIM:NEG:DATA 0,0,0,0,0 CALC:ACP:OFFS:LIST:LIM:NEG:DATA?
Notes	Remote command only.
Preset	SA: -45, -60, 0, 0, 0, 0 -45, -60, 0, 0, 0, 0 WCDMA: -44.2, -49.2, -49.2, -49.2, -49.2, -49.2 -32.2, -42.2, -42.2, -42.2, -42.2, -42.2 C2K: 0, 0, 0, 0, 0, 0 0, 0, 0, 0, 0, 0 WIMAX OFDMA: -50, -60, 0, 0, 0, 0 TD-SCDMA: -40, -45, -45, -45, -45, -45 -33, -43, -43, -43, -43, -43 1xEVDO: -45, -55, -55, -55, -55, -55 -45, -55, -55, -55, -55, -55 DVB-T/H: -60, -60, 0, 0, 0, 0 -60, -60, 0, 0, 0, 0 DTMB (CTTB): -45, -60, -60, -60, 50, 50 -45, -60, -60, -60, 50, 50 ISDB-T: -60, -60, 0, 0, 0, 0 -60, -60, 0, 0, 0, 0 CMMB: -45, -60, -60, -60, 50, 50 -45, -60, -60, -60, 50, 50
State Saved	Saved in instrument state.
Min	-150.0
Max	50.0
Backwards Compatibility SCPI	:CALCulate:MCPower:OFFSet:LIST:LIMit:NEGative[:UPPer]:DATA (PSA Power Suite)
Initial S/W Revision	A.04.00

Rel Lim (PSD)

Enters a relative limit value for the level of the power spectral density. This sets the amplitude levels to test against for any custom offsets. The amplitude level is relative to the power spectral density. If multiple offsets are available, the list contains six (6) entries. The offset closest to the carrier channel is the first one in the list.

[[:SENSe]:ACP:OFFSet[n]:LIST[n]:TEST selects the type of testing to be done at each offset.

You can turn off (not use) specific offsets with the [[:SENSe]:ACP:OFFSet[n]:LIST:STATe command.

The query returns the six (6) sets of real numbers that are the current amplitude test limits, relative to the power spectral density, for each offset.

Offset[n] n=1 is base station and 2 is mobiles. The default is base station (1).

Key Path	Meas Setup, Offset/Limits, Limits
----------	--

ACP Measurement
Meas Setup

Mode	SA, WCDMA, C2K, WIMAX OFDMA, TD-SCDMA, 1xEVDO, DVB-T/H, DTMB (CTTB), ISDB-T, CMMB, LTE, LTETDD
Remote Command	[[:SENSe]:ACPower:OFFSet [1] 2:LIST:RPSDensity <rel_ampl>, <rel_ampl>, <rel_ampl>, <rel_ampl>, <rel_ampl>, <rel_ampl> [:SENSe]:ACPower:OFFSet [1] 2:LIST:RPSDensity?
Example	ACP:OFFS2:LIST:RPSD 10,10,10,10,10,10 ACP:OFFS2:LIST:RPSD?
Notes	Offset sub op code. 1 for BTS, 2 for MS. Default is BTS. Note that Offset sub op code 2 is supported only in Non-SA modes. In the SA mode, Offset sub op code 1 is used for both BTS and MS. You must be in the mode that includes ACP measurements to use this command. Use :INSTrument:SELEct to set the mode.
Preset	SA: -28.87 dB, -43.87 dB, 0 dB, 0 dB, 0 dB, 0 dB -28.87 dB, -43.87 dB, 0 dB, 0 dB, 0 dB, 0 dB WCDMA: -44.2 dB, -49.2 dB, -49.2 dB, -49.2 dB, -49.2 dB, -49.2 dB -32.2 dB, -42.2 dB, -42.2 dB, -42.2 dB, -42.2 dB, -42.2 dB C2K: 0 dB, 0 dB, 0 dB, 0 dB, 0 dB, 0 dB 0 dB, 0 dB, 0 dB, 0 dB, 0 dB, 0 dB WIMAX OFDMA: -25,-35,0,0,0,0 TD-SCDMA: -40 dB, -45 dB, -45 dB, -45 dB, -45 dB, -45 dB -33 dB, -43 dB, -43 dB, -43 dB, -43 dB, -43 dB 1xEVDO: -45, -55, -55, -55, -55, -55 -45, -55, -55, -55, -55, -55 DVB-T/H: -60 dB, -60 dB, 0 dB, 0 dB, 0 dB, 0 dB -60 dB, -60 dB, 0 dB, 0 dB, 0 dB, 0 dB DTMB (CTTB): 50 dB, 50 dB, 50 dB, 50 dB, 50 dB, 50 dB 50 dB, 50 dB, 50 dB, 50 dB, 50 dB, 50 dB ISDB-T: -60 dB, -60 dB, 0 dB, 0 dB, 0 dB, 0 dB -60 dB, -60dB, 0 dB, 0 dB, 0 dB, 0 dB CMMB: 50 dB, 50 dB, 50 dB, 50 dB, 50 dB, 50 dB 50 dB, 50 dB, 50 dB, 50 dB, 50 dB, 50 dB LTE, LTETDD: 0, 0, 0, 0, 0, 0 0, 0, 0, 0, 0, 0
State Saved	Saved in instrument state.
Min	-150.0 dB
Max	50.0 dB
Initial S/W Revision	Prior to A.02.00
Modified at S/W Revision	A.02.00, A.03.00

Fail Mask

Accesses a menu that enables you to select one of the logic keys for the fail conditions between the measurement results and the test limits. The setting defines the type of testing to be done at any custom offset frequencies. The measured powers are tested against the absolute values defined with [:SENSe]:ACP:OFFSet[n]:LIST:ABSolute, or the relative values defined with [:SENSe]:ACP:OFFSet:LIST:RPSDensity and [:SENSe]:ACP:OFFSet:LIST:RCARrier.

You can turn off (not use) specific offsets with the [:SENS]:ACP:OFFSet:LIST:STATe command.

- Absolute – Fail is shown if one of the absolute ACP measurement results is larger than the limit for Abs Limit.
- Relative – Fail is shown if one of the relative ACP measurement results is larger than the limit for Rel Lim (Car) or Rel Lim (PSD).
- Abs AND Rel – Fail is shown if one of the absolute ACP measurement results is larger than the limit for Abs Limit AND one of the relative ACP measurement results is larger than the limit for Rel Lim (Car) or Rel Lim (PSD).
- Abs OR Rel – Fail is shown if one of the absolute ACP measurement results is larger than the limit for Abs Limit OR one of the relative ACP measurement results is larger than the limit for Rel Lim (Car) or Rel Lim (PSD).

Key Path	Meas Setup, Offset/Limits, Limits
Mode	SA, WCDMA, C2K, WIMAX OFDMA, TD-SCDMA, 1xEVDO, DVB-T/H, DTMB (CTTB), ISDB-T, CMMB, LTE, LTETDD
Remote Command	[:SENSe]:ACP:OFFSet [1] 2:LIST:TEST ABSolute AND OR RELative, ABSolute AND OR RELative, ABSolute AND OR RELative, ABSolute AND OR RELative, ABSolute AND OR RELative, ABSolute AND OR RELative [:SENSe]:ACP:OFFSet [1] 2:LIST:TEST?
Example	ACP:OFFS2:LIST:TEST ABS,ABS,ABS,ABS,ABS,ABS ACP:OFFS2:LIST:TEST?
Notes	Offset sub op code. 1 for BTS, 2 for MS. Default is BTS. Note that Offset sub op code 2 is supported only in Non-SA modes. In the SA mode, Offset sub op code 1 is used for both BTS and MS. You must be in the mode that includes ACP measurements to use this command. Use :INSTrument:SElect to set the mode.
Couplings	None If current mode is DTMB (CTTB) or CMMB and current device type is Transmitter, the value from position 2 to position 4 are coupled, changing any one will change the others.

ACP Measurement
Meas Setup

Preset	SA, WCDMA, C2K, TD-SCDMA: REL, REL, REL, REL, REL, REL REL, REL, REL, REL, REL, REL WIMAX OFDMA: REL, REL, REL, REL, REL, REL DVB-T/H: REL, REL, REL, REL, REL, REL DTMB (CTTB): OR,AND, AND,AND, REL, REL CDMA1xEVDO: REL, REL, ABS, REL, REL, REL REL, REL, ABS, REL, REL, REL ISDB-T : REL, REL, REL, REL, REL, REL CMMB : OR,AND, AND,AND, REL, REL LTE, LTETDD: AND, AND, AND, AND, AND, AND AND, AND, AND, AND, AND, AND
State Saved	Saved in instrument state.
Range	Absolute Relative Abs AND Rel (fail if both fail) Abs OR Rel (fail if either fails)
Backwards Compatibility SCPI	[:SENSe]:MCPower:OFFSet[1]2:LIST:TEST
Initial S/W Revision	Prior to A.02.00
Modified at S/W Revision	A.02.00, A.03.0, A.04.000

Offset Side

You can turn off (not use) specific offsets with [:SENSe]:ACPPower:OFFSet[1]2:LIST:SIDE.

- NEGative - negative (lower) sideband only
- BOTH - both of the negative (lower) and positive (upper) sidebands
- POSitive - positive (upper) sideband only

Key Path	Meas Setup, Offset/Limits
Mode	SA, WCDMA, C2K, WIMAX OFDMA, TD-SCDMA, 1xEVDO, DTMB (CTTB), DVB-T/H, CMMB, ISDB-T, LTE, LTETDD
Remote Command	[:SENSe]:ACPPower:OFFSet [1] 2:LIST:SIDE NEGative BOTH POSitive,NEGative BOTH POSitive,NEGative BOTH POSitive,NEGative BOTH POSitive,NEGative BOTH POSitive,NEGative BOTH POSitive,NEGative BOTH POSitive [:SENSe]:ACPPower:OFFSet [1] 2:LIST:SIDE?
Example	ACP:OFFS:LIST:SIDE BOTH ACP:OFFS:LIST:SIDE?

Notes	<p>OFFSet1 is for BTS, 2 for MS. Default is BTS.</p> <p>You must be in the Spectrum Analysis mode, W-CDMA mode, cdma2000 mode, TD-SCDMA mode, DTMB (CTTB) mode, DVB-T/H mode, 1xEVDO mode, WIMAX OFDMA mode, LTE mode or LTETDD mode to use this command. Use :INSTrument:SElect to set the mode.</p> <p>If you set POS or NEG in an offset, result of the inactive side will return –999.</p>
Preset	BOTH, BOTH, BOTH, BOTH, BOTH, BOTH BOTH, BOTH, BOTH, BOTH, BOTH, BOTH
State Saved	Saved in instrument state.
Range	Neg Both Pos
Initial S/W Revision	A.03.00

Method for Offset

This key allows you to turn RRC filtering of each offset on or off. The value (roll off) for the filter will be set to the value of the Filter Alpha parameter.

Key Path	Meas Setup, Offset/Limits
Mode	SA, WCDMA, WIMAX OFDMA, TD-SCDMA, DVB-T/H, DTMB (CTTB), ISDB-T, CMMB, LTE, LTETDD
Remote Command	<p>[:SENSE] :ACPower:OFFSet [1] 2 :LIST:FILTer [:RRC] [:STATe] ON OFF 1 0, ...</p> <p>[:SENSE] :ACPower:OFFSet [1] 2 :LIST:FILTer [:RRC] [:STATe] ?</p>
Example	<p>ACP:OFFS:LIST:FILT 1,0,0</p> <p>ACP:OFFS:LIST:FILT?</p>
Notes	<p>1 ON = RRC Weighted, 0 OFF = Integ BW</p> <p>This parameter is not available for cdma2000 and 1xEVDO.</p> <p>You must be in the mode that includes ACP measurements to use this command. Use :INSTrument:SElect to set the mode.</p>

ACP Measurement
Meas Setup

Preset	SA: 0, 0, 0, 0, 0, 0 0, 0, 0, 0, 0, 0 WCDMA: 1, 1, 1, 1, 1, 1 1, 1, 1, 1, 1, 1 C2K: NO WIMAX OFDMA: 0, 0, 0, 0, 0, 0 0, 0, 0, 0, 0, 0 TD-SCDMA: 1, 1, 1, 1, 1, 1 1, 1, 1, 1, 1, 1 DVB-T/H: 0, 0, 0, 0, 0, 0 0, 0, 0, 0, 0, 0 DTMB (CTTB): 1, 1, 1, 1, 1, 1 1, 1, 1, 1, 1, 1 ISDB-T: 0, 0, 0, 0, 0, 0 0, 0, 0, 0, 0, 0 CMMB: 1, 1, 1, 1, 1, 1 1, 1, 1, 1, 1, 1 LTE: 0, 0, 0, 0, 0, 0 0, 0, 0, 0, 0, 0 LTETDD: 0, 0, 0, 0, 0, 0 0, 0, 0, 0, 0, 0
State Saved	Saved in instrument state.
Range	Integ BW RRC Weighted
Initial S/W Revision	A.03.00

Filter Alpha for Offset

Sets the alpha value for the RRC Filter for each offset.

Key Path	Meas Setup, Offset/Limits, Method, RRC Weighted
Mode	SA, WCDMA, WIMAX OFDMA, TD-SCDMA, DVB-T/H, DTMB (CTTB), ISDB-T, CMMB, LTE, LTETDD
Remote Command	[:SENSe] :ACPpower:OFFSet [1] 2:LIST:FILTer:ALPHa <real>, ... [:SENSe] :ACPpower:OFFSet [1] 2:LIST:FILTer:ALPHa?
Example	ACP:OFFS:LIST:FILT:ALPH 0.5,0.5,0.5,0.5,0.5,0.5 ACP:OFFS:LIST:FILT:ALPH?
Notes	This parameter is not available for cdma2000 and 1xEVDO. You must be in the mode that includes ACP measurements to use this command. Use :INSTrument:SElect to set the mode.

Preset	SA: 0.22,0.22,0.22,0.22,0.22,0.22 0.22,0.22,0.22,0.22,0.22,0.22 WCDMA: 0.22,0.22,0.22,0.22,0.22,0.22 0.22,0.22,0.22,0.22,0.22,0.22 WIMAX OFDMA: 0.22,0.22,0.22,0.22,0.22,0.22 0.22,0.22,0.22,0.22,0.22,0.22 C2K: NO TD-SCDMA: 0.22,0.22,0.22,0.22,0.22,0.22 0.22,0.22,0.22,0.22,0.22,0.22 DVB-T/H: 0.22,0.22,0.22,0.22,0.22,0.22 0.22,0.22,0.22,0.22,0.22,0.22 DTMB (CTTB): 0.05,0.05,0.05,0.05,0.05,0.05 0.05,0.05,0.05,0.05,0.05,0.05 ISDB-T : 0.22,0.22,0.22,0.22,0.22,0.22 0.22,0.22,0.22,0.22,0.22,0.22 CMMB : 0.22,0.22,0.22,0.22,0.22,0.22 0.22,0.22,0.22,0.22,0.22,0.22 LTE: 0.22,0.22,0.22,0.22,0.22,0.22 0.22,0.22,0.22,0.22,0.22,0.22 LTETDD: 0.22,0.22,0.22,0.22,0.22,0.22 0.22,0.22,0.22,0.22,0.22,0.22
State Saved	Saved in instrument state.
Min	0.01
Max	1.00
Initial S/W Revision	A.03.00

Offset Frequency Define

This key allows you to select “Offset” definition. Each standard defines each “Offset” from Carrier.

3GPP2 requires the “From Carrier Center to MeasBW Closer Edge” definition. And LTE conformance test requires “From Carrier Edge to MeasBW Center” and/or “From Carrier Edge to MeasBW Closer Edge” definition.

- CTOCenter – From the center of the carrier closest to the adjacent channel to the center of the adjacent channel's Offset Integ BW
- CTOEdge - From the center of the carrier closest to the adjacent channel to the edge of the closest adjacent channel's Offset Integ BW
- ETOCenter – From Center Frequency - Carrier Spacing / 2 (for lower offset), Center Frequency + Carrier Spacing / 2 (for upper offset) of the carrier closest to the adjacent channel's to the center of the adjacent channel's Offset Integ BW
- ETOEdge - From Center Frequency - Carrier Spacing / 2 (for lower offset), Center Frequency + Carrier Spacing / 2 (for upper offset) of the carrier closest to the adjacent channel's to the edge of the closest adjacent channel's Offset Integ BW

Key Path	Meas Setup, Offset/Limits
Mode	SA, WCDMA, C2K, WIMAX OFDMA, TD-SCDMA, 1xEVDO, DVB-T/H, DTMB (CTTB), ISDB-T, CMMB, LTE, LTETDD

ACP Measurement
Meas Setup

Remote Command	[:SENSe] :ACPower:OFFSet [1] 2 :TYPE CTOCenter CTOEdge ETOCenter ETOEdge [:SENSe] :ACPower:OFFSet [1] 2 :TYPE?
Example	ACP:OFFS:TYPE ETOC ACP:OFFS:TYPE?
Notes	You must be in the mode that includes ACP measurements to use this command. Use :INSTrument:SElect to set the mode.
Preset	CTOCenter
State Saved	Saved in instrument state.
Range	Carrier Center To Meas BW Center Carrier Center To Meas BW Edge Carrier Edge To Meas BW Center Carrier Edge To Meas BW Edge
Initial S/W Revision	A.03.00

Carrier Result

Allows you to view and scroll through the carrier power results.

Key Path	Meas Setup
Mode	SA, WCDMA, C2K, WIMAX OFDMA, TD-SCDMA, 1xEVDO, DVB-T/H, DTMB (CTTB), ISDB-T, CMMB, LTE, LTETDD
Couplings	This key will be grayed out if there is only one carrier.
Preset	1
State Saved	No
Min	1
Max	Number of carriers.
Initial S/W Revision	Prior to A.02.00
Modified at S/W Revision	A.02.00, A.03.00

PhNoise Opt

Selects the LO (local oscillator) phase noise behavior for various operating conditions.

Key Path	Meas Setup
Initial S/W Revision	Prior to A.02.00

PhNoise Opt Auto

Selects the best LO (local oscillator) phase noise behaviour for ACP measurement.

Auto works as follows:

Look at all the offsets that are "on."

Find the largest and the smallest of the Freq Offset parameters for those offsets.

Take the mean.

Compare that mean with the crossover frequency for the LO in use (see below).

If the mean is below the crossover frequency, use "best close-in," otherwise use "best wide-offset."

Crossover frequency for PXA is 195 kHz, for MXA and CXA, 25 kHz.

Key Path	Meas Setup
Mode	SA, WCDMA, C2K, WIMAX OFDMA, TD-SCDMA, 1xEVDO, DVB-T/H, DTMB (CTTB), ISDB-T, CMMB, LTE, LTETDD
Remote Command	[:SENSe] :ACPpower:FREQuency:SYNThesis:AUTO[:STATe] OFF ON 0 1 [:SENSe] :ACPpower:FREQuency:SYNThesis:AUTO[:STATe] ?
Example	ACP:FREQ:SYNT:AUTO 1 ACP:FREQ:SYNT:AUTO?
Preset	ON
State Saved	Saved in instrument state.
Range	Auto Man
Initial S/W Revision	Prior to A.02.00
Modified at S/W Revision	A.02.00, A.03.00, A.04.00

PhNoise Opt State

Selects the LO (local oscillator) phase noise behavior for various operating conditions.

Key Path	Meas Setup
Mode	SA, WCDMA, C2K, WIMAX OFDMA, TD-SCDMA, 1xEVDO, DVB-T/H, DTMB (CTTB), ISDB-T, CMMB, LTE, LTETDD
Remote Command	[:SENSe] :ACPpower:FREQuency:SYNThesis[:STATe] 1 2 3 [:SENSe] :ACPpower:FREQuency:SYNThesis[:STATe] ?
Example	ACP:FREQ:SYNT 1 ACP:FREQ:SYNT?
Notes	Parameter key: 1 - optimizes phase noise for close-in from the carrier. 2 - optimizes phase noise for wide-offset from the carrier. 3 - optimizes LO for tuning speed.

Preset	Because this function is in Auto after preset, the state of this function after Preset will be automatically calculated.
State Saved	Saved in instrument state.
Range	Hardware Dependent: PXA: Best Close-in Noise [offset < 140 kHz] Best Wide-offset Noise [offset > 160 kHz] Fast Tuning MXA: Best Close-in Noise [offset < 20 kHz] Best Wide-offset Noise [offset > 30 kHz] Fast Tuning CXA: NA
Initial S/W Revision	Prior to A.02.00
Modified at S/W Revision	A.02.00, A.03.00, A.04.00

Meas Method

Sets the desired method to measure ACP.

Integration BW — one sweep of the trace is taken, and the band power for each offset is computed. Depending on the status of the Meas Type parameter (Total Power Reference or PSD Reference), results are displayed relative to the total power or the power spectral density. The display reflects either the current trace or a bar graph view.

Filtered IBW (max dynamic range) — ACP Path is used to compute ACP when an ACP path is available. This method increases dynamic range, but increases measurement time as it limits the resolution bandwidth. This method is useful for improving dynamic range on W-CDMA signal because of a sharp cutoff band pass filter is used. The accuracy of the adjacent channel power ratio is not degraded by this method, but the absolute accuracy of both adjacent channel power and carrier power are degraded by up to about 0.5 dB.

RBW — the algorithm uses zero-span and an appropriate RBW setting to capture all of the power in the carrier channel and the offsets. The zero-span algorithm (RBW method) is slower than the IBW method, but greatly improves repeatability.

Fast (in WCDMA mode or SA mode with 3GPP WCDMA radio standard selected) — this provides the same method as the Integration BW method, but with optimized for speed to measure W-CDMA signal.

Fast (in CDMA2K mode or SA mode with CDMA2K radio standard selected) – this provides faster measurement using FFT method with the limited parameter flexibility. When this is selected, CDMA2K preset offsets are given and control of follows are grayed out.

BW menu, Sweep/Control menu except Pause/Resume, Trace/Detector menu, Carrier Setup, Offset Limit, RRC Weighting, Filter Alpha and Noise Correction softkeys in MeasSetup menu

In the TD-SCDMA mode, only the Integration BW method is available. Therefore, the Meas Method key is not displayed in the TD-SCDMA mode.

Key Path	Meas Setup
----------	------------

Mode	SA, WCDMA, C2K, WIMAX OFDMA, 1xEVDO, DVB-T/H, DTMB (CTTB), ISDB-T, CMMB, LTE, LTETDD
Remote Command	[:SENSe] :ACPower:METhod IBW IBWRange FAST RBW [:SENSe] :ACPower:METhod?
Example	ACP:METh IBW ACP:METh?
Notes	In the TDSCDMA mode, only the IBW method is available to use. Therefore, the measure method key is not displayed in the TD-SCDMA mode. CDMA 1xEVDO mode only supports RBW and Integration BW method. C2K mode only supports RBW, Integration BW and FAST method. FAST mode is only supported for WCDMA and C2K signal. You must be in the WCDMA or C2K mode or SA mode with 3GPP WCDMA or CDMA2K radio standard. Otherwise a setting conflict error message will be reported. Supporting FAST mode in C2K is available with the instrument version A.02.00 or later LTETDD mode only supports Integration BW and Filtered IBW method. You must be in the mode that includes ACP measurements to use this command. Use :INSTrument:SELEct to set the mode.
Couplings	IBW (Range) restricts the Res BW available for making this measurement to 30kHz. When selected the Res Bw will be clipped to this value if required and an error number displayed.
Preset	SA, LTE, LTETDD: IBW WCDMA: IBW C2K: RBW WIMAX OFDMA: IBW 1xEVDO: IBW DVB-T/H: IBW DTMB (CTTB): IBW ISDB-T: IBW CMMB: IBW
State Saved	Saved in instrument state.
Range	Integration BW Filtered IBW (max dynamic range) RBW Fast
Readback Text	IBW Filtered IBW RBW Fast
Backwards Compatibility SCPI	[:SENSe]:ACPR:SWEEp:TYPE [:SENSe]:MCPower:METhod (PSA Power Suite)
Initial S/W Revision	Prior to A.02.00

ACP Measurement
Meas Setup

Modified at S/W Revision	A.02.00, A.03.00
--------------------------	------------------

Meas Type

Changes the reference used for the measurement. This allows you to make absolute and relative power measurements of either total power or the power normalized to the measurement bandwidth.

Total Pwr Ref (TPR) sets the reference to the total carrier power. PSD Ref (PSDR) sets the reference to the power spectral density of the carrier.

Key Path	Meas Setup
Mode	SA, WCDMA, C2K, WIMAX OFDMA, TD-SCDMA, 1xEVDO, DVB-T/H, DTMB (CTTB), ISDB-T, CMMB, LTE, LTETDD
Remote Command	[:SENSe] :ACPower:TYPE TPRef PSDRef [:SENSe] :ACPower:TYPE?
Example	ACP:TYPE PSDR ACP:TYPE?
Notes	You must be in the mode that includes ACP measurements to use this command. Use :INSTrument:SElect to set the mode.
Preset	TPRef
State Saved	Saved in instrument state.
Range	Total Power Ref PSD Ref
Initial S/W Revision	Prior to A.02.00
Modified at S/W Revision	A.02.00, A.03.00

PSD Ref

Sets the unit bandwidth for Power Spectral Density. The available units are dBm/Hz and dBm/MHz.

Key Path	Meas Setup
Mode	A, WCDMA, C2K, WIMAX OFDMA, TD-SCDMA, 1xEVDO, DVB-T/H, DTMB (CTTB), ISDB-T, CMMB, LTE, LTETDD
Remote Command	:UNIT:ACPower:POWer:PSD DBMHZ DBMMHZ :UNIT:ACPower:POWer:PSD?
Example	UNIT:ACP:POW:PSD DBMMHZ UNIT:ACP:POW:PSD?
Couplings	When the PSD unit is changed, the PSD reference result of the “MEAS READ FETCH:ACP[n]?” is also changed by the PSD unit basis (in either dBm/Hz or dBm/MHz).
Preset	DBMHZ

State Saved	Saved in instrument state.
Range	dBm/Hz dBm/MHz
Initial S/W Revision	Prior to A.02.00
Modified at S/W Revision	A.02.00, A.03.00

Limit Test

Turns limit checking for each offset On or Off. The limits may be specified within the Offset menu, for each offset, both sides of the carrier. For results that fail the limit, a red F is appended. In the Combined view, the bar turns red.

Key Path	Meas Setup
Mode	SA, WCDMA, C2K, WIMAX OFDMA, TD-SCDMA, 1xEVDO, DVB-T/H, DTMB (CTTB), ISDB-T, CMMB, LTE, LTETDD
Remote Command	:CALCulate:ACPower:LIMit:STATe OFF ON 0 1 :CALCulate:ACPower:LIMit:STATe?
Example	CALC:ACP:LIM:STAT OFF CALC:ACP:LIM:STAT?
Notes	You must be in the mode that includes ACP measurements to use this command. Use :INSTrument:SElect to set the mode.
Preset	SA: OFF WCDMA: ON C2K: ON WIMAX OFDMA: OFF TD-SCDMA: ON 1xEVDO: ON DVB-T/H: OFF DTMB (CTTB): ON ISDB-T: OFF CMMB: ON LTE, LTETDD: ON
State Saved	Saved in instrument state.
Range	On Off
Backwards Compatibility SCPI	[.:SENSe]:MCPower:LIMit[:STATe] [:SENSe]:ACPower:LIMit[:STATe]
Initial S/W Revision	Prior to A.02.00

Modified at S/W Revision	A.02.00, A.03.00
--------------------------	------------------

Noise Correction

Sets the measurement noise floor correction function to On or Off. On enables measurement noise correction when the measured power in the reference channel or any offset is close to the noise floor of the analyzer. Off turns these corrections off.

In analyzers with the noise floor extensions option (option NFE) enabled, there are two ways to compensate for the analyzer noise floor: through the NFE and through this noise corrections key. The techniques are results are similar but not identical. NFE uses a model of the analyzer noise floor, adapted to the current conditions such as center frequency, RBW and ambient temperature. The parameters of this model are measured in the factory or field calibration in a highly averaged measurement. So they are consistent. However, because the model is imperfect, the corrections are imperfect. Using NFE is very convenient; the user need not wait for the ACP noise corrections calibration to occur. The ACP NC calibration, though, has advantages of being measured very recently, at the current ambient, and the exact center frequency, with no requirement that the model be perfect. So it will often (but not always) have slightly better dynamic range. If both ACP NC is turned on and NFE is turned on, the analyzer uses only the ACP NC. When ACP NC is turned off but NFE is on, NFE is used and performance should still be excellent.

Key Path	Meas Setup
Mode	SA, WCDMA, C2K, WIMAX OFDMA, TD-SCDMA, 1xEVDO, DVB-T/H, DTMB (CTTB), ISDB-T, CMMB, LTE, LTETDD
Remote Command	[:SENSe] :ACPpower:CORRection:NOISe [:AUTO] OFF ON 0 1 [:SENSe] :ACPpower:CORRection:NOISe [:AUTO] ?
Example	ACP:CORR:NOIS OFF ACP:CORR:NOIS?
Notes	You must be in the mode that includes ACP measurements to use this command. Use :INSTrument:SELEct to set the mode.
Preset	0
State Saved	Saved in instrument state.
Range	On Off
Initial S/W Revision	Prior to A.02.00
Modified at S/W Revision	A.02.00, A.03.00, A.04.00

Meas Preset

Restores all the measurement parameters to their default values.

Key Path	Meas Setup
----------	------------

Mode	SA, WCDMA, C2K, WIMAX OFDMA, TD-SCDMA, 1xEVDO, DVB-T/H, DTMB (CTTB), ISDB-T, CMMB, LTE, LTETDD
Remote Command	:CONFigure:ACPoweR
Example	CONF:ACP
Notes	You must be in the mode that includes ACP measurements to use this command. Use :INSTrument:SElect to set the mode.
Couplings	Selecting Meas Preset will restore all measurement parameters to their default values.
Initial S/W Revision	Prior to A.02.00
Modified at S/W Revision	A.02.00, A.03.00

Offset RRC Weighting (Backward Compatibility SCPI)

Mode	SA, WCDMA, TD-SCDMA, WIMAX OFDMA, DVB-T/H, DTMB (CTTB), ISDB-T, CMMB, LTE, LTETDD
Remote Command	[:SENSe] :ACPower:FILTer [:RRC] [:STATe] OFF ON 0 1 [:SENSe] :ACPower:FILTer [:RRC] [:STATe] ?
Example	ACP:FILT OFF ACP:FILT?
Notes	This parameter is not available for cdma2000 and 1xEVDO The backwards Compatibility SCPI command, [:SENSe] :ACPR:FILTer [:RRC] [:STATe], is provided to support same functionality as [:SENSe] :ACPr:FILTer [:RRC] [:STATe] (PSA W-CDMA, PSA cdma2000 and PSA 1xEVDO) due to ACPr node conflicts with ACPower node. You must be in the mode that includes ACP measurements to use this command. Use :INSTrument:SELEct to set the mode.
Couplings	This command is an alias to [:SENSe] :ACPower:OFFSet [1] [2] :LIST:FILTer [:RRC] [:STATe] Sending the commands to set values of all offsets for BS and MS, however, sending the query always return a value of BS Offset A.
Preset	SA, WIMAX OFDMA, LTE, LTETDD: OFF WCDMA: ON C2K: NO TD-SCDMA: ON DVB-T/H: OFF DTMB (CTTB):ON ISDB-T: OFF CMMB: OFF
State Saved	Saved in instrument state.
Backwards Compatibility SCPI	[:SENSe] :ACPR:FILTer [:RRC] [:STATe] [:SENSe] :MCPower:FILTer [:RRC] [:STATe]
Initial S/W Revision	Prior to A.02.00
Modified at S/W Revision	A.03.00

Offset Filter Alpha (Backward Compatibility SCPI)

Mode	SA, WCDMA, WIMAX OFDMA, TD-SCDMA, DVB-T/H, DTMB (CTTB), ISDB-T, CMMB, LTE, LTETDD
Remote Command	[:SENSe] :ACPower:FILTer[:RRC]:ALPHa <real> [:SENSe] :ACPower:FILTer[:RRC]:ALPHa?
Example	ACP:FILT:ALPH 0.5 ACP:FILT:ALPH?
Notes	This parameter is not available for cdma2000 and 1xEVDO The backwards Compatibility SCPI command, [:SENSe]:ACPR:FILTer[:RRC]:ALPHa, is provided to support same functionality as [:SENSe]:ACPr:FILTer[:RRC]:ALPHa (PSA W-CDMA, PSA cdma2000 and PSA 1xEVDO) due to ACPr node conflicts with ACPower node. You must be in the mode that includes ACP measurements to use this command. Use :INSTrument:SElect to set the mode.
Couplings	This command is an alias to [:SENSe]:ACPower:OFFSet[1] 2:LIST:FILTer:ALPHa Sending the commands to set values of all offsets for BS and MS, however, sending the query always return a value of BS Offset A.
Preset	SA, WCDMA, WIMAX OFDMA, TD-SCDMA, DVB-T/H, ISDB-T, CMMB, LTE, LTETDD: 0.22 C2K: NO DTMB (CTTB): 0.05
State Saved	Saved in instrument state.
Min	0.01
Max	1.00
Backwards Compatibility SCPI	[:SENSe]:ACPR:FILTer[:RRC]:ALPHa [:SENSe]:MCPower:FILTer[:RRC]:ALPHa
Initial S/W Revision	Prior to A.02.00
Modified at S/W Revision	A.03.00

Method for Carrier (Backward Compatibility SCPI)

Mode	SA, WCDMA, WIMAX OFDMA, TD-SCDMA, DVB-T/H, DTMB (CTTB), ISDB-T, CMMB, LTE, LTETDD
Remote Command	[:SENSe] :ACPower:CARRier [1] 2:LIST:METHod IBW RRC, ... [:SENSe] :ACPower:CARRier [1] 2:LIST:METHod?

ACP Measurement
Meas Setup

Example	ACP:CARR2:LIST:METH RRC ACP:CARR2:LIST:METH?
Notes	You must be in the mode that includes ACP measurements to use this command. Use :INSTrument:SELEct to set the mode. Maximum of Array length depends on the number of carriers.
Couplings	This command is an alias to [:SENSe]:ACPower:CARRier[1] 2:LIST:FILTer[:RRC][:STATe] The enum value translates as follows: RRC Weighted = 1 ON Integ BW = 0 OFF Maximum of Array length depends on the number of carriers.
Preset	SA: IBW WCDMA: RRC WIMAX OFDMA: IBW TD-SCDMA: RRC DVB-T/H: IBW DTMB (CTTB): RRC ISDB-T: IBW CMMB: IBW LTE: IBW LTETDD: IBW
State Saved	Saved in instrument state.
Initial S/W Revision	Prior to A.02.00
Modified at S/W Revision	A.03.00

Mode

See [“Mode” on page 1123](#) in the "Common Measurement Functions" section for more information.

Mode Setup

See “[Mode Setup](#)” on page 1141 in the "Common Measurement Functions" section for more information.

Peak Search

Accesses a menu that enables you to control the peak search function.

Key Path	Front-panel key
Initial S/W Revision	Prior to A.02.00

Peak Search

Places the selected marker on the trace point with the maximum y-axis value.

Key Path	Peak Search
Mode	SA, WCDMA, C2K, WIMAX OFDMA, TD-SCDMA, 1xEVDO, DVB-T/H, DTMB (CTTB), ISDB-T, CMMB, LTE, LTETDD
Remote Command	:CALCulate:ACPower:MARKer [1] 2 3 4 5 6 7 8 9 10 11 12 :MAXimum
Example	CALC:ACP:MARK2:MAX
Initial S/W Revision	Prior to A.02.00
Modified at S/W Revision	A.02.00, A.03.00

Next Peak

Moves the selected marker to the peak that has the next highest amplitude.

Key Path	Peak Search
Mode	SA, WCDMA, C2K, WIMAX OFDMA, TD-SCDMA, 1xEVDO, DVB-T/H, DTMB (CTTB), ISDB-T, CMMB, LTE, LTETDD
Remote Command	:CALCulate:ACPower:MARKer [1] 2 3 4 5 6 7 8 9 10 11 12 :MAXimum:NEXT
Example	CALC:ACP:MARK2:MAX:NEXT
Initial S/W Revision	Prior to A.02.00
Modified at S/W Revision	A.02.00, A.03.00

Next Pk Right

Moves the selected marker to the nearest peak to the right of the current marker that meets all enabled peak criteria.

Key Path	Peak Search
----------	--------------------

ACP Measurement
Peak Search

Mode	SA, WCDMA, C2K, WIMAX OFDMA, TD-SCDMA, 1xEVDO, DVB-T/H, DTMB (CTTB), ISDB-T, CMMB, LTE, LTETDD
Remote Command	:CALCulate:ACPower:MARKer [1] 2 3 4 5 6 7 8 9 10 11 12 :MAXimum:RIGHT
Example	CALC:ACP:MARK2:MAX:RIGH
Initial S/W Revision	Prior to A.02.00
Modified at S/W Revision	A.02.00, A.03.00

Next Pk Left

Moves the selected marker to the nearest peak to the left of the current marker that meets all enabled peak criteria.

Key Path	Peak Search
Mode	SA, WCDMA, C2K, WIMAX OFDMA, TD-SCDMA, 1xEVDO, DVB-T/H, DTMB (CTTB), ISDB-T, CMMB, LTE, LTETDD
Remote Command	:CALCulate:ACPower:MARKer [1] 2 3 4 5 6 7 8 9 10 11 12 :MAXimum:LEFT
Example	CALC:ACP:MARK2:MAX:LEFT
Initial S/W Revision	Prior to A.02.00
Modified at S/W Revision	A.02.00, A.03.00

Marker Delta

Sets the control mode for the selected marker to Delta mode.

See Marker Delta in the "Marker Functions" section for more information.

Key Path	Peak Search
Initial S/W Revision	Prior to A.02.00

Pk-Pk Search

Finds and displays the amplitude and frequency (or time, if in zero span) differences between the highest and lowest y-axis value.

Key Path	Peak Search
Mode	SA, WCDMA, C2K, WIMAX OFDMA, TD-SCDMA, 1xEVDO, DVB-T/H, DTMB (CTTB), ISDB-T, CMMB, LTE, LTETDD
Remote Command	:CALCulate:ACPower:MARKer [1] 2 3 4 5 6 7 8 9 10 11 12 :PTPeak

Example	CALC:ACP:MARK:PTP
Notes	Turns on the Marker Δ active function.
Couplings	This key is not available (key is grayed out) when Coupled Markers is on.
Initial S/W Revision	Prior to A.02.00
Modified at S/W Revision	A.02.00, A.03.00

Min Search

Moves the selected marker to the minimum y-axis value on the current trace.

Key Path	Peak Search
Mode	SA, WCDMA, C2K, WIMAX OFDMA, TD-SCDMA, 1xEVDO, DVB-T/H, DTMB (CTTB), ISDB-T, CMMB, LTE, LTETDD
Remote Command	:CALCulate:ACPower:MARKer [1] 2 3 4 5 6 7 8 9 10 11 12 :M INimum
Example	CALC:ACP:MARK:MIN
Initial S/W Revision	Prior to A.02.00
Modified at S/W Revision	A.02.00, A.03.00

Recall

See [“Recall” on page 153](#) for more information.

State

See [“State” on page 153](#) for more information.

Data

See [“Data \(Import\)” on page 160](#) for more information.

Masks

See [“Mask” on page 163](#) for more information.

Restart

See [“Restart” on page 1163](#) in the "Common Measurement Functions" section for more information.

Save

See “[Save](#)” on page 170 in the "Common Measurement Functions" section for more information.

Single

See [“Single \(Single Measurement/Sweep\)”](#) on page 1169 in the "Common Measurement Functions" section for more information.

Source

See [“Source” on page 1171](#) in the "Common Measurement Functions" section for more information.

SPAN X Scale

Accesses a menu of functions that enable you set the horizontal scale parameters.

Key Path	Front-panel key
Initial S/W Revision	Prior to A.02.00

Span

Changes the frequency range symmetrically about the center frequency.

The default (and minimum) span is calculated using the number of carriers and the carrier width where;

$$\text{Span} = (\text{Upper Carrier Freq} + (\text{max offset IBW} * (1 + \alpha)) / 2) - (\text{Lower Carrier Freq} - (\text{max offset IBW} * (1 + \alpha)) / 2)$$

The span is increased by a factor of 1 + Filter Alpha if the RRC Filter is on.

Key Path	SPAN X Scale
Mode	SA, WCDMA, C2K, WIMAX OFDMA, TD-SCDMA, 1xEVDO, DVB-T/H, DTMB (CTTB), ISDB-T, CMMB, LTE, LTETDD
Remote Command	[:SENSe] :ACPower:FREQuency:SPAN <freq> [:SENSe] :ACPower:FREQuency:SPAN?
Example	ACP:FREQ:SPAN 25MHz ACP:FREQ:SPAN?
Notes	You must be in the mode that includes ACP measurements to use this command. Use :INSTrument:SElect to set the mode.
Couplings	The span value is clipped when the carrier settings and/or the offset settings are changed. The value is changed to satisfy following formula: Span = (Upper Carrier Freq + (max offset IBW * (1 + alpha)) / 2) - (Lower Carrier Freq - (max offset IBW * (1 + alpha)) / 2)

ACP Measurement
SPAN X Scale

Preset	SA: 8 MHz WCDMA: 24.6848 MHz WIMAX OFDMA: 50MHz C2K: 4.5 MHz TD-SCDMA: 8MHz 1xEVDO: 4.05 MHz DVB-T/H: 40MHz DTMB (CTTB): 72MHz ISDB-T: 30MHz CMMB: 72MHz LTE, LTETDD: 15MHz
State Saved	Saved in instrument state.
Min	10 Hz
Max	Hardware Dependent: Option 503 = 3.7 GHz Option 507 = 7.1 GHz Option 508 = 8.5 GHz Option 513 = 13.8 GHz Option 526 = 27.0 GHz
Initial S/W Revision	Prior to A.02.00
Modified at S/W Revision	A.02.00, A.03.00

Full Span

Changes the span to show the full frequency range of the spectrum analyzer.

Key Path	SPAN X Scale
Mode	SA, WCDMA, C2K, WiMAX OFDMA, TD-SCDMA, 1xEVDO, DVB-T/H, DTMB (CTTB), ISDB-T, CMMB, LTE, LTETDD
Remote Command	[:SENSe] :ACPpower :FREQuency :SPAN :FULL
Example	ACP:FREQ:SPAN:FULL
Notes	You must be in the mode that includes ACP measurements to use this command. Use :INSTrument:SElect to set the mode.
Initial S/W Revision	Prior to A.02.00
Modified at S/W Revision	A.02.00, A.03.00

Last Span

Changes the span to the previous span setting. If no previous span value exists, then the span will remain unchanged.

Key Path	SPAN X Scale
Mode	SA, WCDMA, C2K, WIMAX OFDMA, TD-SCDMA, 1xEVDO, DVB-T/H, DTMB (CTTB), ISDB-T, CMMB, LTE, LTETDD
Remote Command	[:SENSe] :ACPower:FREQuency:SPAN:PREVious
Example	ACP:FREQ:SPAN:PREV
Notes	You must be in the mode that includes ACP measurements to use this command. Use :INSTrument:SELEct to set the mode.
Initial S/W Revision	Prior to A.02.00
Modified at S/W Revision	A.02.00, A.03.00

Sweep/Control

Accesses a menu of functions that enable you to set up and control the sweep time, and source.

See “Sweep/Control” on page 1181 in the "Common Measurement Functions" section for more information.

Key Path	Front-panel key
Initial S/W Revision	Prior to A.02.00

Sweep Time

Selects the length of time in which the spectrum analyzer sweeps the displayed frequency span. In swept spans, the sweep time varies from 1 millisecond to 2000 seconds. Additional overhead time, which impacts the sweep rate, is not calculated as part of the sweep time. In fact:

sweep rate = span/sweep time

update rate = 1/(sweep time + overhead)

sweep cycle time = sweep time + overhead

Sweep time is coupled to RBW and VBW, and is impacted by the number of sweep points, so changing those parameters may change the sweep time.

If you increase the sweep time, you increase the length of the time data captured and the number of points measured. You might need to specify a specific sweep speed to accommodate a specific condition in your transmitter. For example, you may have a burst signal and need to measure an exact portion of the burst.

Selecting a specific sweep time may result in a long measurement time since the resulting number of data points may not be the optimum 2n. Use [:SENSE]:ACP:OFFSet:LIST:SWEep:TIME to set the number of points used for measuring the offset channels for Basic and cdmaOne.

For cdma2000 and W-CDMA, this command sets the sweep time when using the sweep mode. See [:SENSE]:ACP:SWEep:TYPE

Key Path	Sweep/Control
Mode	SA, WCDMA, C2K, WIMAX OFDMA, TD-SCDMA, 1xEVDO, DVB-T/H, DTMB (CTTB), ISDB-T, CMMB, LTE, LTETDD
Remote Command	<pre>[:SENSE]:ACP:Power:SWEep:TIME <time> [:SENSE]:ACP:Power:SWEep:TIME? [:SENSE]:ACP:Power:SWEep:TIME:AUTO OFF ON 0 1 [:SENSE]:ACP:Power:SWEep:TIME:AUTO?</pre>

Example	ACP:SWE:TIME 50ms ACP:SWE:TIME? ACP:SWE:TIME:AUTO OFF ACP:SWE:TIME:AUTO?
Notes	This parameter is preset by Meas Method selection. Preset values are as follows: IBW: 29 ms IBWR: 108 ms FAST (WCDMA): 7.5 ms
Couplings	When you manually change the Sweep Time, this state automatically goes to 'Man'.
Preset	SA, LTE, LTETDD: Automatically calculated WCDMA: 29 ms WIMAX OFDMA: Automatically calculated C2K: Automatically calculated TD-SCDMA: Automatically calculated 1xEVDO: Automatically calculated DVB-T/H: Automatically calculated DTMB (CTTB): Automatically calculated ISDB-T: Automatically calculated CMMB: Automatically calculated SA, LTE, LTETDD: ON WCDMA: OFF C2K: OFF(mehtod IBW) WIMAX OFDMA: ON TD-SCDMA: ON DVB-T/H: ON DTMB (CTTB): ON ISDB-T: ON CMMB: ON
State Saved	Saved in instrument state.
Min	1 ms
Max	4000 s
Initial S/W Revision	Prior to A.02.00
Modified at S/W Revision	A.02.00, A.03.00

Sweep Setup

Accesses the sweep setup menu.

Key Path	Sweep/Control
Initial S/W Revision	Prior to A.02.00

Auto Sweep Time Rules

Switches the analyzer between normal and accuracy sweep states.

Key Path	Sweep/Control, Sweep Setup
Mode	SA, WCDMA, C2K, WIMAX OFDMA, TD-SCDMA, 1xEVDO, DVB-T/H, DTMB (CTTB), ISDB-T, CMMB, LTE, LTETDD
Remote Command	[:SENSE] :ACPower :SWEep :TIME :AUTO :RULes NORMal ACCuracy [:SENSE] :ACPower :SWEep :TIME :AUTO :RULes?
Example	ACP:SWE:TIME:AUTO:RUL NORM ACP:SWE:TIME:AUTO:RUL?
Notes	Set to Norm when Auto Couple is pressed or sent remotely.
Preset	SA, WCDMA, C2K, TD-SCDMA, 1xEVDO, DTMB (CTTB), LTE, LTETDD: ACCuracy WIMAX OFDMA, DVB-T/H: NORMal ISDB-T, CMMB: NORMal
State Saved	Saved in instrument state.
Range	Norm Accy
Initial S/W Revision	Prior to A.02.00
Modified at S/W Revision	A.02.00, A.03.00

Pause

Pauses a measurement after the current data acquisition is complete. When Paused, the label on the key changes to Resume. Pressing the Resume key resumes the measurement at the point it was at when paused. See [“Pause/Resume” on page 1193](#) in “Common Measurement Functions” for more details.

Key Path	Sweep/Control
Initial S/W Revision	Prior to A.02.00

Gate

Accesses a menu that enables you to control the gating function .The Gate functionality is used to view signals best viewed by qualifying them with other events.

Gate Method that lets you choose one of the three different types of gating is not available in this measurement.

See “Gate ” on page 1194 in “common Measurement Functions” for more details.

Key Path	Sweep/Control
Initial S/W Revision	Prior to A.02.00

Points

Sets the number of points per sweep, from 1 to 20001. The sweep time resolution setting will depend on the number of points selected.

Key Path	Sweep/Control
Mode	SA, WCDMA, C2K, WIMAX OFDMA, TD-SCDMA, 1xEVDO, DVB-T/H, DTMB (CTTB), ISDB-T, CMMB, LTE, LTETDD
Remote Command	[:SENSe] :ACPower:SWEep:POINts <integer> [:SENSe] :ACPower:SWEep:POINts?
Example	ACP:SWE:POIN 500 ACP:SWE:POIN?
Notes	Whenever the number of sweep points changes: <ul style="list-style-type: none"> • All trace data is erased • Any traces with Update Off will also go to Display Off (like going from View to Blank in the older analyzers) • Sweep time is re-quantized • Any limit lines that are on will be updated • If averaging/hold is on, averaging/hold starts over
Couplings	Whenever the number of sweep points changes, the sweep time is re-quantized.
Preset	Others: 1001 DVB-T/H:2001 DTMB (CTTB): 2001 ISDB-T: 2001 CMMB: 2001
State Saved	Saved in instrument state.
Min	1
Max	20001
Initial S/W Revision	Prior to A.02.00

ACP Measurement
Sweep/Control

Modified at S/W Revision	A.02.00, A.03.00
--------------------------	------------------

Trace/Detector

Accesses a menu of functions that enable you to control the detectors for the current measurement.

Key Path	Front-panel key
Initial S/W Revision	Prior to A.02.00

Select Trace (front panel only)

This key selects which trace the other parameters under the Trace/Detector menu will apply to.

Key Path	Trace/Detector
Notes	Front panel only.
Couplings	When MeasMethod is RBW or FAST, Select Trace is disabled.
Preset	1
State Saved	Saved in instrument state.
Range	1 2 3
Initial S/W Revision	Prior to A.02.00

Trace Type

Allows you to select the type of trace for the current measurement. The first page of this menu contains a selection of the trace type (Clear Write, Trace Average, Max Hold, Min Hold) for the selected trace.

Key Path	Trace/Detector
Mode	SA, WCDMA, C2K, WIMAX OFDMA, TD-SCDMA, 1xEVDO, DVB-T/H, DTMB (CTTB), ISDB-T, CMMB, LTE, LTETDD
Remote Command	:TRACe [1] 2 3 :ACPpower:TYPE WRITe AVERAge MAXHold MINHold :TRACe [1] 2 3 :ACPpower:TYPE?
Example	TRAC:ACP:TYPE MINH TRAC:ACP:TYPE?
Notes	WRITe = Clear Write AVERAge = Average MAXHold = Maximum Hold MINHold = Minimum Hold

ACP Measurement
Trace/Detector

Couplings	When Detector setting is “Auto” ([:SENSe]:ACPower:DETECTOR:AUTO?), Detector is set to what the Radio Standard defaults states (see detector section below) for all conditions of Trace Type and for all traces. When set to Manual, all Traces use the same detector type. When Average State = Off then Trace Types AVERAGE, MaxHold and MinHold will not function, since Averaging is required to be ‘on’ for them to operate. When MeasMethod is RBW or FAST, Trace Type is disabled.
Preset	AVERAGE
State Saved	Saved in instrument state.
Initial S/W Revision	Prior to A.02.00
Modified at S/W Revision	A.02.00
Modified at S/W Revision	A.03.00

View / Blank

Enables you to select how to view the displayed trace.

Key Path	Trace/Detector
Mode	SA,WCDMA, C2K, WIMAX OFDMA, TD-SCDMA, 1xEVDO, DVB-T/H, DTMB (CTTB), ISDB-T, CMMB, LTE, LTETDD
Notes	No . remote control. Front panel only.
Couplings	The four states of this 1-of-N actually set two variables, Update and Display, to their four possible combinations. Trace On: Update and Display both On View: Update Off and Display On (Not implemented) Blank: Update Off and Display Off Background: Update On, Display Off (Not implemented) See tables below for detail on remote commands to control these two variables. Selecting a trace type (Clear Write, Trace Average, Max Hold, Min Hold) for a trace (pressing the key or sending the equivalent remote command) puts the trace in ‘Trace On’ state (Update On and Display On), even if that trace type was already selected. When MeasMethod is RBW or FAST, this key is grayed out.
Preset	Trace On
State Saved	Saved in instrument state.
Range	Trace On Blank
Initial S/W Revision	Prior to A.02.00
Modified at S/W Revision	A.03.00

Key Path	Trace/Detector
Mode	WCDMA, C2K, WIMAX OFDMA, TD-SCDMA, 1xEVDO, DVB-T/H, DTMB (CTTB), ISDB-T, CMMB, LTE, LTETDD
Remote Command	:TRACe [1] 2 3 :ACPpower:UPDate [:STATe] ON OFF 0 1 :TRACe [1] 2 3 :ACPpower:UPDate [:STATe] ?
Example	TRAC:ACP:UPD ON TRAC:ACP:UPD?
Couplings	Whenever you set Update to On for any trace, the Display is set to On for that trace. When MeasMethod is RBW or FAST, Trace Update is disabled.
Preset	1 0 0 (On for Trace 1; Off for 2 &3)
State Saved	Saved in instrument state.
Range	0 1
Initial S/W Revision	Prior to A.02.00
Modified at S/W Revision	A.03.00

Key Path	Trace/Detector
Mode	WCDMA, C2K, WIMAX OFDMA, TD-SCDMA, 1xEVDO, DVB-T/H, DTMB (CTTB), ISDB-T, CMMB, LTE, LTETDD
Remote Command	:TRACe [1] 2 3 :ACPpower:DISPlay [:STATe] ON OFF 0 1 :TRACe [1] 2 3 :ACPpower:DISPlay [:STATe] ?
Example	TRAC:ACP:DISP ON TRAC:ACP:DISP?
Couplings	Whenever you set Update to On for any trace, the Display is set to On for that trace. When MeasMethod is RBW or FAST, Trace Display is disabled.
Preset	1 0 0 (On for Trace 1; Off for 2 &3)
State Saved	Saved in instrument state.
Range	0 1
Initial S/W Revision	Prior to A.02.00
Modified at S/W Revision	A.03.00

Detector

Accesses a menu of functions that enables you to control the detectors for the current measurement. Extended in MXA6 to allow up to 3 traces, but each use the same detector type choice hereThe following

ACP Measurement
Trace/Detector

choices are available:

- Auto- the detector selected is set to AVERAge, unless the Radio Standard defaults state otherwise e.g. it is set to Peak for Radio Standard = PDC when Device = both MS and BTS, and when Radio Standard = NADC and Device = MS .
- Normal-the detector determines the peak of the CW-like signals, and it yields alternating maximums and minimums of noise-like signals. This is also referred to as Rosenfell detection.
- Average-the detector determines the average of the signal within the sweep points. The averaging method is Power (RMS).).
- Peak-the detector determines the maximum of the signal within the sweep points.
- Sample-the detector indicates the instantaneous level of the signal at the center of the sweep points represented by each display point.
- Negative Peak-the detector determines the minimum of the signal within the sweep points.

In swept analysis, the time interval of the data collection for the display sweep points also represents a frequency interval. In FFT analysis, the sweep points represents just a frequency interval. The detector determines the relationship between the spectrum computed by the FFT and the single data point displayed for the sweep points.

Key Path	Trace/Detector
Initial S/W Revision	Prior to A.02.00

Auto

Sets the detector for the currently selected trace to auto.

Key Path	Trace/Detector
Mode	SA, WCDMA, C2K, WIMAX OFDMA, TD-SCDMA, 1xEVDO, DVB-T/H, DTMB (CTTB), ISDB-T, CMMB, LTE, LTETDD
Remote Command	[:SENSe] :ACPower:DETEctor:AUTO ON OFF 1 0 [:SENSe] :ACPower:DETEctor:AUTO?
Example	ACP:DET:AUTO 1 ACP:DET?
Couplings	When Detector setting is “Auto” ([:SENSe] :ACPower:DETEctor:AUTO?), Detector is set to what the Radio Standard defaults states (see detector section) for all conditions of Trace Type and for all traces. When set to Manual, all Traces use the same detector type. When Average State = Off then Trace Types AVERAge, MaxHold and MinHold will not function, since Averaging is required to be ‘on’ for them to operate.
Preset	ON
State Saved	Saved in instrument state.
Range	ON OFF

Initial S/W Revision	Prior to A.02.00
Modified at S/W Revision	A.02.00, A.03.00

Detector Selection

Selects a detector to be used by the analyzer for the current measurement. All traces will use the same detector type, similar to Monitor Spectrum measurement

Key Path	Trace/Detector
Mode	SA, WCDMA, C2K, WIMAX OFDMA, TD-SCDMA, 1xEVDO, DVB-T/H, DTMB (CTTB), ISDB-T, CMMB, LTE, LTETDD
Remote Command	[:SENSE] :ACPower:DETECTOR [:FUNCTION] AVERAge NEGAtive NORMAl POSitive SAMPLe [:SENSE] :ACPower:DETECTOR [:FUNCTION] ?
Example	ACP:DET NORM ACP:DET?
Notes	<p>When you manually select a detector (instead of selecting Auto), that detector is used regardless of other analyzer settings.</p> <p>The detector choices are:</p> <ul style="list-style-type: none"> • The Normal detector determines the peak of CW-like signals, and it yields alternating maximums and minimums of noise-like signals. This is also referred to as Rosenfell detection. • The Average detector determines the average of the signal within the data range. The averaging method method is Power (RMS). • The Peak detector determines the maximum of the signal within the data range. • The Sample detector indicates the instantaneous level of the signal at the center of the data represented by each display point. • The Negative Peak detector determines the minimum of the signal within the data range. <p>Because they may not find a spectral component's true peak, neither average nor sample detectors measure amplitudes of CW signals as accurately as peak or normal, but they do measure noise without the biases of peak detection.</p> <p>When a detector selection is made, the menu returns to the previous menu.</p>
Couplings	<p>When Detector setting is "Auto" ([:SENSE]:ACPower:DETECTOR:AUTO?), Detector is set to what the Radio Standard defaults states (see detector section) for all conditions of Trace Type and for all traces. When set to Manual, all Traces use the same detector type. When Average State = Off then Trace Types AVERAge, MaxHold and MinHold will not function, since Averaging is required to be 'on' for them to operate.</p> <p>Only one detector type for all 3 traces is allowed.</p> <p>When MeasMethod is RBW or FAST, Detector is disabled.</p>

ACP Measurement
Trace/Detector

Preset	AVERAge
State Saved	Saved in instrument state.
Range	Normal Average Peak Sample Negative Peak
Backwards Compatibility SCPI	[:SENSe]:ACPR:SWEep:DETEctor[:FUNCTion]
Initial S/W Revision	Prior to A.02.00
Modified at S/W Revision	A.02.00, A.03.00

Trigger

Accesses a menu functions that enable you to select and control the trigger source for the current measurement. See [“Trigger” on page 1251](#) in the "Common Measurement Functions" section for more information.

Key Path	Front-panel key
Initial S/W Revision	Prior to A.02.00

View/Display

Accesses a menu of functions that enable you to control the instrument display as well as turn the bar graph On and Off.

The view consists of the following two windows:

“Spectrum Window” on page 474

“Results Window” on page 474

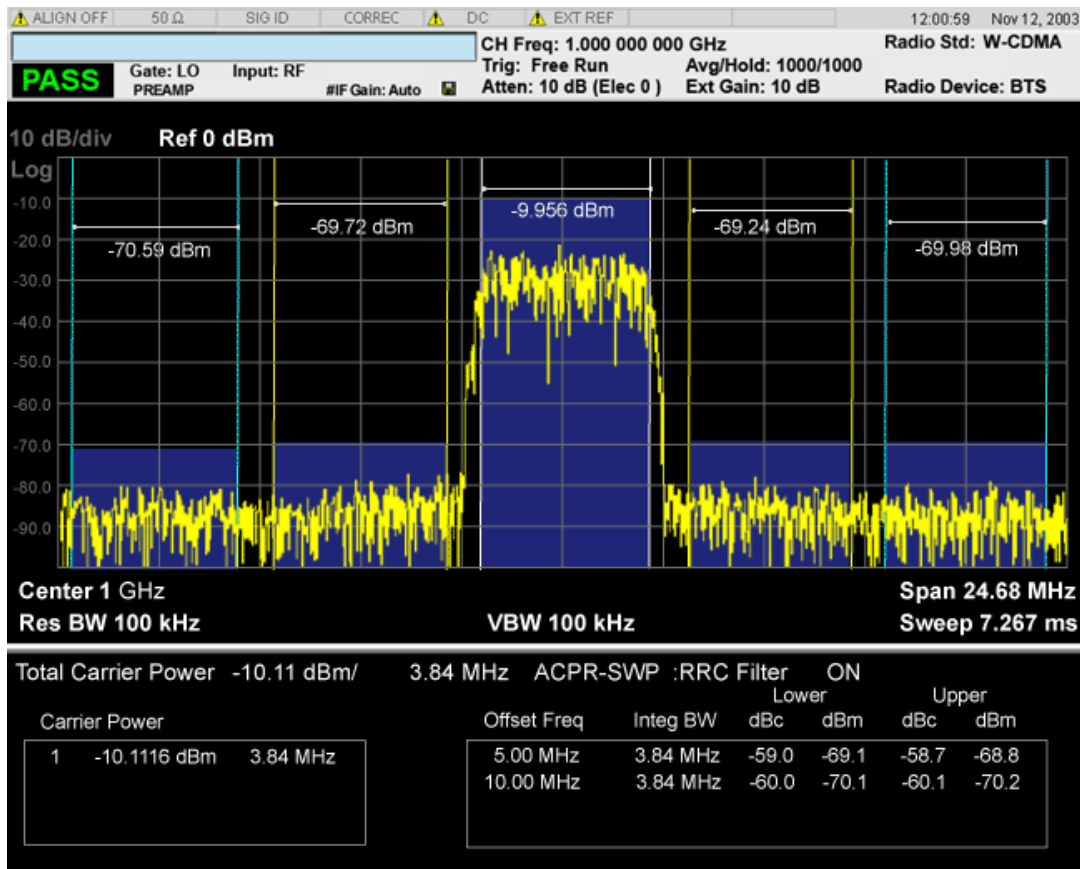

The following two views are only for DTMB (CTTB) and CMMB:DTMB and CMMB Transmitter:

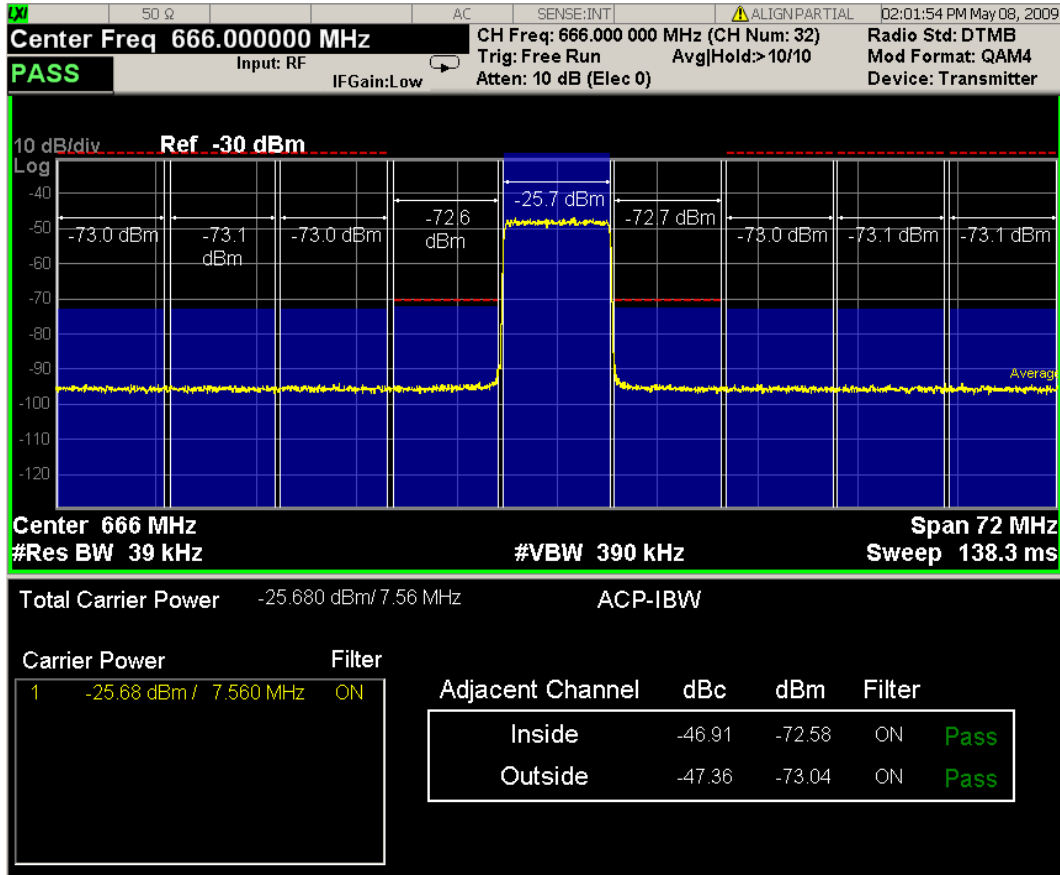

DTMB and CMMB Exciter:

ACP Measurement
View/Display

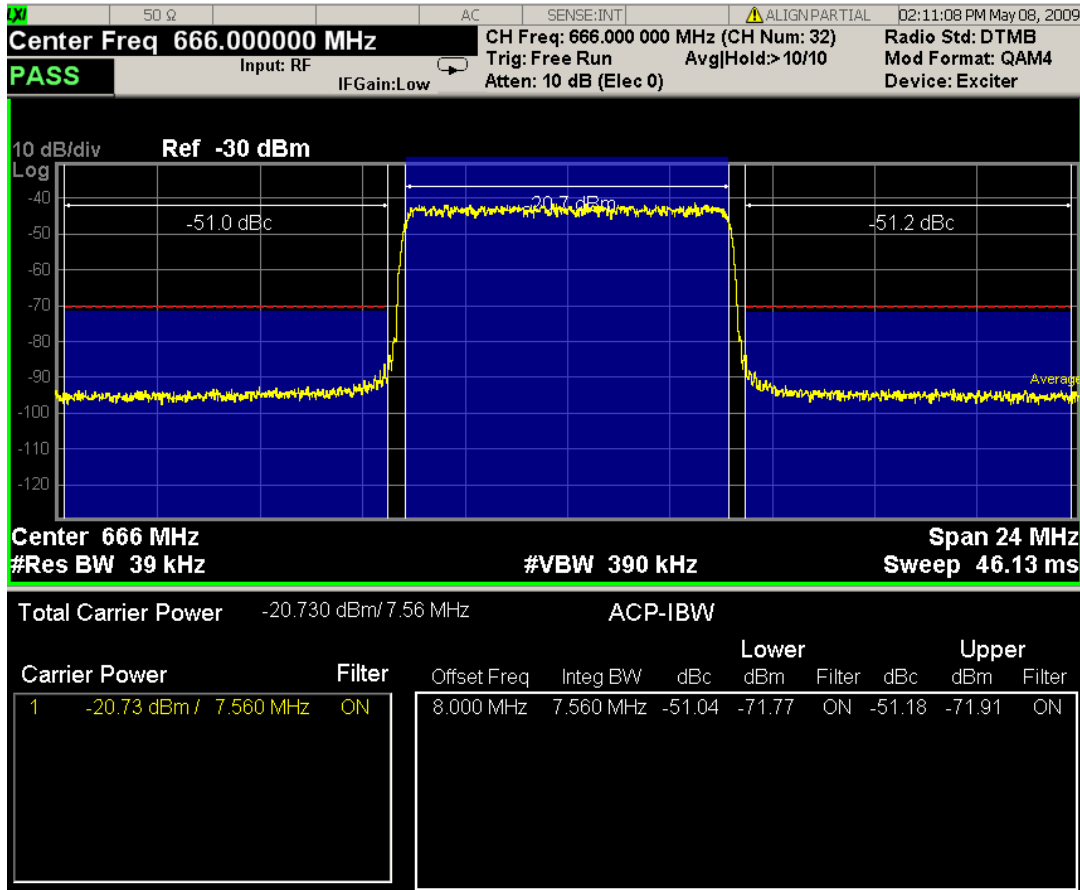

Spectrum Window

When the Bar Graph is On and Limit Test is On, the color of each bar graph reflects the limit test result. When the limit test fails, the bar color is red, and when limit test passes, the bar color is blue.

When RBW is selected as the measurement method, the spectrum trace is not displayed, only the bar graph is displayed. In addition, the Bar Graph key (under the View/Display front panel key) is set to ON and is grayed out.

The RRC Filter display item is only displayed when RRC filter is on.

Results Window

The text window displays the following results:

Total Carrier Power

This is the total power of all the carriers with carrier power present set to yes. The power is calculated by integrating across the bandwidth declared by the Carrier Integ Bw parameter for each carrier and then totaling the sums. The total integration bandwidth is shown as part of the result. This will be the total of the Carrier Integ Bw of the carriers used in calculating the total carrier power. If the RRC Filter is on, then the integration bandwidth used is $(1 + \alpha)/T$ where $T = 1/(\text{Carrier Integ Bw})$ multiplied by the number of carriers with carrier power present set to yes.

Ref Carrier Power

This is the power in the reference carrier. The power is calculated by integrating across the bandwidth declared by the Carrier Integ Bw parameter for that carrier. The integration bandwidth is shown as part of the result. This is the value of the Carrier Integ Bw for that carrier unless the RRC Filter is on, then the integration bandwidth used is the displayed value, which is $(1 + \alpha)/T$ where $T = 1/(\text{Carrier Integ Bw})$.

Carrier Power

This is the power in all the currently defined carriers. If the carrier has carrier power present, the power will be absolute. If the carrier is defined as not having power present, the power will be relative to the reference carrier. The power is calculated by integrating across the bandwidth declared by the Carrier Integ Bw parameter. The integration bandwidth is shown as part of the result. This is the value of the Carrier Integ Bw for the carrier unless the RRC Filter is on, then the integration bandwidth used is the displayed value, which is $(1 + \alpha)/T$ where $T = 1/(\text{Carrier Integ Bw})$.

As there are potentially more results than can be easily viewed on the display, a scrollable list is used to display all results. The Carrier Results menu key is used to index the carrier amplitude results. This key is grayed out unless the measurement is in single mode (as in continual measurement mode). The display is continuously updating and will not need to be accessed. The currently selected Carrier Result is displayed on the last line of the carrier power result list unless:

- The selected Carrier Result is 4 or less in normal multi carrier power results view. In this case the first 4 carrier power results will be displayed.
- The selected Carrier Result is 9 or greater in normal multi carrier power results view. In this case the last 4 carrier power results will be displayed.
- The zoom mode is selected. In this case all carrier power ranges can be displayed.

Offset Relative Power

This is the power in the offsets relative to the reference carrier. The power is calculated by integrating across the bandwidth declared by the Offset Integ Bw parameter. The offset integration bandwidth is shown as part of the result. This is the value on the Offset Integ Bw menu key unless the RRC Filter is on, then the integration bandwidth used is the displayed value, which is $(1 + \alpha)/T$ where $T = 1/(\text{Offset Integ Bw})$.

Offset Absolute Power

This is the absolute power in the offsets. The power is calculated by integrating across the bandwidth declared by the Offset Integ Bw parameter. The offset integration bandwidth is shown as part of the result. This is the value on the Offset Integ Bw menu key unless the RRC Filter is on, then the integration bandwidth used is the displayed value, which is $(1 + \alpha)/T$ where $T = 1/(\text{Offset Integ Bw})$.

Inside Adjacent Channel Power (DTMB (CTTB) and CMMA only)

This result is only valid for DTMB (CTTB) transmitter and CMMA transmitter. It contains two parts: Relative Power and Absolute Power. The power is calculated by integrating across the bandwidth (Integ Bw) at the frequency Offset A.

Inside Absolute Power = MAX (P_{Lower Offset A}, P_{Upper Offset A});

Inside Relative Power = Inside Absolute Power – Carrier Power;

Outside Adjacent Channel Absolute Power (DTMB (CTTB) and CMMA only)

ACP Measurement
View/Display

This result is only valid for DTMB (CTTB) transmitter and CMMB transmitter. It contains two parts: Relative Power and Absolute Power. The power is the Root-Mean-Square of the power calculated by integrating across the bandwidth (Integ Bw) at frequency Offset B, C and D.

$$\text{Outside Absolute Power} = \sqrt{\frac{P_{\text{Lower OffsetB}}^2 + P_{\text{Upper OffsetB}}^2 + P_{\text{Lower OffsetC}}^2 + P_{\text{Upper OffsetC}}^2 + P_{\text{Lower OffsetD}}^2 + P_{\text{Upper OffsetD}}^2}{6}}$$

Outside Relative Power = Outside Absolute Power – Carrier Power;

Key Path	Front-panel key
Initial S/W Revision	Prior to A.02.00

Display

Accesses a menu of functions that enable you to set the display parameters.

See “[Display](#)” on page 1313 in the "Common Measurement Functions" section for more information.

Key Path	View/Display
Initial S/W Revision	Prior to A.02.00

Bar Graph

Turns the Bar Graph On and Off.

Key Path	View/Display
Mode	SA, WCDMA, C2K, WIMAX OFDMA, TD-SCDMA, 1xEVDO, DVB-T/H, DTMB (CTTB), ISDB-T, CMMB, LTE, LTETDD
Remote Command	:DISPlay:ACPpower:VIEW[1]:WINDow[1]:BGRaph OFF ON 0 1 :DISPlay:ACPpower:VIEW[1]:WINDow[1]:BGRaph?
Example	DISP:ACP:VIEW:WIND:BGR OFF DISP:ACP:VIEW:WIND:BGR?
Notes	You must be in the mode that includes ACP measurements to use this command. Use :INSTrument:SElect to set the mode.
Dependencies	When the method is RBW, this key is always set to On and grayed out.
Preset	ON
State Saved	Saved in instrument state.
Range	On Off
Initial S/W Revision	Prior to A.02.00

Modified at S/W Revision	A.02.00, A.03.00
--------------------------	------------------

Many of the digitally modulated signals now look noise-like in the time and frequency domain. This means that statistical measurements of the signals can be a useful characterization. Power Complementary Cumulative Distribution Function (CCDF) curves characterize the higher level power statistics of a digitally modulated signal. The curves can be useful in determining design parameters for digital communications systems. For more information, see [“Power Stat CCDF Measurement Description” on page 481](#). For measurement results and views, see [“View/Display” on page 518](#).

This topic contains the following sections:

[“Measurement Commands for Power Stat CCDF” on page 479](#)

[“Remote Command Results for Power Stat CCDF” on page 480](#)

Measurement Commands for Power Stat CCDF

The general functionality of CONFigure, FETCh, MEASure, and READ are described at the beginning of this section. See the SENSE:PStat commands for more measurement related commands.

```
:CONFigure:PStatistic  
:CONFigure:PStatistic:NDEFault  
:INITiate:PStatistic  
:FETCh:PStatistic [n] ?  
:READ:PStatistic [n] ?  
:MEASure:PStatistic[n]?
```

For more measurement related commands, see the SENSE subsystem, and the section [“Remote Measurement Functions” on page 1083](#).

Remote Command Results for Power Stat CCDF

n	Results Returned
0	Returns unprocessed I/Q trace data, as a series of trace point values, in volts. The I values are listed first in each pair, using the 0 through even-indexed values. The Q values are the odd-indexed values,
not specified or 1	Returns 10 scalar results: <ol style="list-style-type: none"> 1. Average input power (in dBm) 2. Probability at the average input power level (in %) 3. Power level that has 10% of the power 4. Power level that has 1% of the power 5. Power level that has 0.1% of the power 6. Power level that has 0.01% of the power 7. Power level that has 0.001% of the power 8. Power level that has 0.0001% of the power 9. Peak power (in dB) 10.Count
2	Returns a series of 5001 floating the current measured power stat trace. This is the probability at particular power levels (average power), in the following order: <ol style="list-style-type: none"> 1. Probability at 0.0 dB power 2. Probability at 0.01 dB power 3. Probability at 0.02 dB power ... 1. Probability at 49.9 dB power 2. Probability at 50.0 dB power
3	Returns a series of 5001 floating point numbers (in percent) that represent the Gaussian trace. This is the probability at particular power levels (average power), in the following order: <ol style="list-style-type: none"> 1. Probability at 0.0 dB power 2. Probability at 0.01 dB power 3. Probability at 0.02 dB power ... 1. Probability at 49.9 dB power 2. Probability at 50.0 dB power

n	Results Returned
4	Returns a series of 5001 floating point numbers (in percent) that represent the user-definable reference trace. This is the probability at particular power levels (average power), in the following order: <ol style="list-style-type: none"> 1. Probability at 0.0 dB power 2. Probability at 0.01 dB power 3. Probability at 0.02 dB power ... 1. Probability at 49.9 dB power 2. Probability at 50.0 dB power

Power Stat CCDF Measurement Description

The power statistics CCDF measurement can be affected by many factors. For example, modulation filtering, modulation format, combining the multiple signals at different frequencies, number of active codes, and correlation between symbols on different codes with spread spectrum systems will all affect measurement results. These factors are all related to modulation and signal parameters. External factors such as signal compression and expansion by nonlinear components, group delay distortion from filtering, and power control within the observation interval also affect the measurement.

The power measured in power statistics CCDF curves is actually instantaneous envelope power defined by the equation:

$$P = (I^2 + Q^2) / Z_0$$

(Where I&Q are the quadrature voltage components of the waveform and Z₀ is the characteristic impedance).

A CCDF curve is defined by how much time the waveform spends at or above a given power level. The percent of time the signal spends at or above the level defines the probability for that particular power level. For capturing a lower probability down to 0.0001%, this measurement is made in the single mode by pressing Single. To make the power statistics CCDF measurement, the instrument uses digital signal processing (DSP) to sample the input signal in the channel bandwidth. The Gaussian distribution line as the band-limited Gaussian noise CCDF reference line, the user-definable reference trace, and the currently measured trace can be displayed on a semi-log graph. If the currently measured trace is above the user reference trace, it means that the higher peak power levels against the average power are included in the input signal.

Key Path	Meas
----------	------

AMPTD Y Scale

Accesses a menu of functions that enable you to set the vertical scale parameters. The parameter values are measurement independent except all Attenuation values, and the Internal Preamp selection, which are the same across all measurements.

Key Path	Front-panel key
Initial S/W Revision	Prior to A.02.00

Attenuation

Accesses a menu of functions that enable you to change the attenuation settings. This key has read-back text that describes the total attenuator value.

See AMPTD Y Scale, “[Attenuation](#)” on page 910 in the “Common Measurement Functions” section for more information.

This is only available when the selected input is RF.

Key Path	AMPTD Y Scale
Initial S/W Revision	Prior to A.02.00

Range

Accesses the Range menu to change baseband I/Q gain settings. This key has a readback text that describes gain range value. Refer to “[Range](#)” on page 919 in the “Common Measurement Functions” for more information.

Key Path	AMPTD Y Scale
Initial S/W Revision	Prior to A.02.00

Presel Center

When this key is pressed, the centering of the preselector filter is adjusted to optimize the amplitude accuracy at the frequency of the selected marker.

See AMPTD Y Scale, “[Presel Center](#)” on page 926 in the “Common Measurement Functions” section for more information.

This is only available when the selected input is RF.

Key Path	AMPTD Y Scale
Initial S/W Revision	Prior to A.02.00

Presel Adjust

Allows you to manually adjust the preselector filter frequency to optimize its response to the signal of interest. This function is only available when Presel Center is available.

See AMPTD Y Scale, “[Preselector Adjust](#)” on page 927 in the “Common Measurement Functions” section for more information.

This is only available when the selected input is RF.

Key Path	AMPTD Y Scale
Initial S/W Revision	Prior to A.02.00

Y Axis Unit

Allows you to change the vertical (Y) axis amplitude unit.

See “[Y Axis Unit](#)” on page 929 under AMPTD Y Scale in the "Common Measurement Functions" section for more information.

Key Path	AMPTD Y Scale
Initial S/W Revision	A.04.00

Reference Level Offset

Adds an offset value to the displayed reference level. The reference level is the absolute amplitude represented by the top graticule line on the display.

See “[Reference Level Offset](#)” on page 934 under AMPTD Y Scale in the "Common Measurement Functions" section for more information.

Key Path	AMPTD Y Scale
Initial S/W Revision	A.04.00

μ W Path Control

The μ W Path Control functions include the μ W Preselector Bypass (Option MPB) and Low Noise Path (Option LNP) controls in the High Band path circuits.

See μ “ [\$\mu\$ W Path Control](#) ” on page 935 under AMPTD Y Scale in the "Common Measurement Functions" section for more information.

Key Path	AMPTD Y Scale
Initial S/W Revision	A.04.00

Internal Preamp

Accesses a menu of functions that enable you to control the internal preamplifiers.

See AMPTD Y Scale, “[Internal Preamp](#)” on page 939 in the “Common Measurement Functions” section for more information.

This is only available when the selected input is RF.

Key Path	AMPTD Y Scale
Initial S/W Revision	Prior to A.02.00

Auto Couple

See [“Auto Couple” on page 943](#) in the "Common Measurement Functions" section for more information.

BW

Opens the BW menu, which contains keys to control the information bandwidth functions of the instrument.

Key Path	Front-panel key
Initial S/W Revision	Prior to A.02.00

Info BW

Allows you to enter a frequency value to set the channel bandwidth that will be used for data acquisition.

Key Path	BW
Mode	SA, WCDMA, C2K, WIMAXOFDMA, TD-SCDMA, 1xEV-DO, DVB-T/H, DTMB (CTTB), ISDB-T, CMMB, LTE, LTETDD
Remote Command	[[:SENSE]:PSTatistic:BANDwidth <freq> [:SENSE]:PSTatistic:BANDwidth?
Example	PST:BAND 8 MHz PST:BAND?
Couplings	WiMAX OFDMA: The default value depends on the Radio Standard selection..
Preset	SA, WCDM: 5 MHz C2K:1.5 MHz 1xEV-DO:1.3 MHz WiMAX OFDMA: Hardware Dependent No Option = 10 MHz WB (25 MHz or wider) = 25 MHz TD-SCDMA: 1.3 MHz DVB-T/H, DTMB (CTTB): 8 MHz ISDB-T: 6 MHz CMMB: 8 MHz LTE, LTETDD: 6 MHz
State Saved	Saved in instrument state.
Min	10.0 kHz

Max	Hardware Dependent: RF Input: No Option = 10 MHz WB (25MHz or wider) = Hardware Option Limit I/Q Input (for I+jQ): No Option = 20 MHz Option B25 = 50 MHz
Backwards Compatibility SCPI	[:SENSe]:PStatistic:BWIDth
Initial S/W Revision	Prior to A.02.00
Modified at S/W Revision	A.02.00, A.03.00, A.06.00

Cont

See “[Cont \(Continuous Measurement/Sweep\)](#)” on page 957 in the "Common Measurement Functions" section for more information.

FREQ Channel

See “[FREQ Channel](#)” on page 959 in the "Common Measurement Functions" section for more information.

Input/Output

See “[Input/Output](#)” on page 969 in the "Common Measurement Functions" section for more information.

Marker

Accesses a menu that enables you to select, set up and control the markers for the current measurement.

Key Path	Front-panel key
Initial S/W Revision	Prior to A.02.00

Select Marker

Accesses a menu that allows you to select one of 12 markers for control and function

Key Path	Marker
Initial S/W Revision	Prior to A.02.00

Marker Type

Sets the marker control mode to **Normal**, **Delta**, **Fixed** or **Off**.

If the selected marker is Off, pressing Marker sets it to Normal and places it at the center of the screen on the trace determined by the **Marker Trace** rules. At the same time, **Marker X Axis Value** appears on the Active Function area.

The Active function for the selected marker's current control mode is the default active function. If the current control mode is Off, there is no active function and the active function is turned off. The active function display is the marker X axis value entered in the active function area will display the marker value to its full entered precision.

All interactions and dependencies detailed under the key description are enforced when the remote command is sent.

Key Path	Marker
Mode	SA, WCDMA, C2K, WiMAX OFDMA, TD-SCDMA, 1xEV-DO, DVB-T/H, DTMB (CTTB), ISDB-T, CMMB, LTE, LTETDD
Remote Command	:CALCulate:PStatistic:MARKer[1] 2 3 4 5 6 7 8 9 10 11 12 :MODE POSITION DELTA OFF :CALCulate:PStatistic:MARKer[1] 2 3 4 5 6 7 8 9 10 11 12 :MODE?
Example	CALC:PST:MARK:MODE POS CALC:PST:MARK:MODE?

Notes	<p>If the selected marker is Off, pressing Marker sets it to Normal and places it at the center of the screen on the trace determined by the Marker Trace rules. At the same time, Marker X Axis Value appears on the Active Function area.</p> <p>Default Active Function: the active function for the selected marker's current control mode. If the current control mode is Off, there is no active function and the active function is turned off.</p> <p>Active Function Display: the marker X axis value entered in the active function area will display the marker value to its full entered precision.</p>
Preset	OFF
State Saved	Saved in instrument state.
Range	Normal Delta Off
Initial S/W Revision	Prior to A.02.00
Modified at S/W Revision	A.02.00, A.03.00

Marker X Axis Value (Remote Command Only)

Sets the marker X Axis value in the current marker X Axis Scale unit. This function has no effect if the control mode is **Off**, but is the remote command equivalent of entering an X value if the control mode is **Normal** or **Delta**.

Mode	SA, WCDMA, C2K, WIMAXOFDMA, TD-SCDMA, 1xEV-DO, DVB-T/H, DTMB (CTTB), ISDB-T, CMMB, LTE, LTETDD
Remote Command	<pre>:CALCulate:PSTatic:MARKer[1] 2 3 4 5 6 7 8 9 10 11 12 :X <rel_amp></pre> <pre>:CALCulate:PSTatic:MARKer[1] 2 3 4 5 6 7 8 9 10 11 12 :X?</pre>
Example	<pre>CALC:PST:MARK3:X 0</pre> <pre>CALC:PST:MARK3:X?</pre>
Notes	<p>If no suffix is sent, it will use the fundamental units for the current marker X Axis Scale. If a suffix is sent that does not match the current marker X Axis Scale unit, an error "Invalid suffix" will be generated. If the specified marker is Fixed and a Marker Function is on, error -221 "Settings conflict; cannot adjust Fixed marker while Marker Function is on" is generated.</p> <p>The query returns the marker's absolute X Axis value if the control mode is Normal, or the offset from the marker's reference marker if the control mode is Delta. The query is returned in the fundamental units for the current marker X Axis scale: Hz for Frequency and Inverse Time, seconds for Period and Time. If the marker is Off the response is not a number.</p>
Preset	After a preset, all Markers are turned OFF, so Marker X Axis Value query will return a not a number (NAN).
State Saved	No

Min	-9.9E+37
Max	9.9E+37
Initial S/W Revision	Prior to A.02.00
Modified at S/W Revision	A.02.00, A.03.00

Marker Y Axis Value (Remote Command Only)

Queries the marker Y Axis value in the current marker Y Axis unit.

Mode	SA, WCDMA, C2K, WIMAXOFDMA, TD-SCDMA, 1xEV-DO, DVB-T/H, DTMB (CTTB), ISDB-T, CMMB, LTE, LTETDD
Remote Command	:CALCulate:PStatistic:MARKer[1] 2 3 4 5 6 7 8 9 10 11 12:Y?
Example	CALC:PST:MARK11:Y?
Notes	The query returns the marker Y-axis result, if the control mode is Normal , or Delta . If the marker is Off the response is not a number.
Preset	0
State Saved	No
Backwards Compatibility SCPI	:CALCulate:PStatistic:MARKer[1] 2 3 4 5 6 7 8 9 10 11 12:FUNCTION:RESult?
Initial S/W Revision	Prior to A.02.00
Modified at S/W Revision	A.02.00, A.03.00

Properties

Accesses the marker properties menu.

Key Path	Marker
Initial S/W Revision	Prior to A.02.00

Select Marker

Accesses a menu that allows you to select one of 12 markers for control and function

Key Path	Marker, Properties
Initial S/W Revision	Prior to A.02.00

Relative To

Sets the reference marker that the selected marker will be relative to.

Key Path	Marker, Properties
Mode	SA, WCDMA, C2K, WIMAXOFDMA, TD-SCDMA, 1xEV-DO, DVB-T/H, DTMB (CTTB), ISDB-T, CMMB, LTE, LTETDD
Remote Command	:CALCulate:PSTatistic:MARKer[1] 2 3 4 5 6 7 8 9 10 11 12:REFerence <integer> :CALCulate:PSTatistic:MARKer[1] 2 3 4 5 6 7 8 9 10 11 12:REFerence?
Example	CALC:PST:MARK:REF 3 CALC:PST:MARK:REF?
Notes	A marker cannot be relative to itself so that choice is grayed out, and if sent from SCPI generates error -221: "Settings conflict; marker cannot be relative to itself." When queried a single value will be returned (the specified marker numbers relative marker).
Preset	2 3 4 5 6 7 8 9 10 11 12 1
State Saved	Saved in instrument state.
Min	1
Max	12
Initial S/W Revision	Prior to A.02.00
Modified at S/W Revision	A.02.00, A.03.00

Marker Trace

Assigns the specified marker to the designated trace. The trace choices are: Measured, Gaussian, or Reference.

Key Path	Marker
Mode	SA, WCDMA, C2K, WIMAXOFDMA, TD-SCDMA, 1xEV-DO, DVB-T/H, DTMB (CTTB), ISDB-T, CMMB, LTE, LTETDD
Remote Command	:CALCulate:PSTatistic:MARKer[1] 2 3 4 5 6 7 8 9 10 11 12:TRACe MEASured GAUSSian REFerence :CALCulate:PSTatistic:MARKer[1] 2 3 4 5 6 7 8 9 10 11 12:TRACe?
Example	CALC:PST:MARK3:TRAC MEAS CALC:PST:MARK:TRACE?
Preset	MEASured

State Saved	Saved in instrument state.
Range	Measured Gaussian Reference
Initial S/W Revision	Prior to A.02.00
Modified at S/W Revision	A.02.00, A.03.00

Couple Markers

When this function is true, moving any marker causes an equal X axis movement of every other marker which is not **Off**. By “equal X axis movement” we mean that we preserve the difference between each marker’s X axis value (in the fundamental x-axis units of the trace that marker is on) and the X axis value of the marker being moved (in the same fundamental x-axis units).

Key Path	Marker
Initial S/W Revision	Prior to A.02.00

All Markers Off

Turns off all markers.

Key Path	Marker, More
Mode	SA, WCDMA, C2K, WIMAXOFDMA, TD-SCDMA, 1xEV-DO, DVB-T/H, DTMB (CTTB), ISDB-T, CMMB, LTE, LTETDD
Remote Command	:CALCulate:PStatistic:MARKer:AOff
Example	CALC:PST:MARK:AOff
Initial S/W Revision	Prior to A.02.00
Modified at S/W Revision	A.02.00, A.03.00

Marker To

There is no 'Marker To' functionality supported in Power Stat CCDF measurement. The front-panel key will display a blank key menu when pressed.

Key Path	Front-panel key
Initial S/W Revision	Prior to A.02.00

Marker Function

There are no 'Marker Functions' supported in Power Stat CCDF measurement. The front-panel key will display a blank key menu when pressed.

Key Path	Front-panel key
Initial S/W Revision	Prior to A.02.00

Meas

See “[Meas](#)” on page 1083 in the "Common Measurement Functions" section for more information.

Meas Setup

Accesses the functions that allow you to change the settings for your measurement requirements.

Key Path	Front-panel key
Initial S/W Revision	Prior to A.02.00

Counts

Sets the accumulated number of sampling points for data acquisition. The range is 1.000 kpt (k point) to 2.00000 Gpt (G point) with 1 kpt resolution. Counts couples to Meas Cycles. When the value for counts is changed, the Meas Cycles value will be $(\text{Counts} / \text{SamplingFrequency} * \text{MeasInterval})$.

Key Path	Meas Setup
Mode	SA, WCDMA, C2K, WIMAXOFDMA, TD-SCDMA, 1xEV-DO, DVB-T/H, DTMB (CTTB), ISDB-T, CMMB, LTE, LTETDD
Remote Command	[:SENSE] :PStatistic:COUNTs <integer> [:SENSE] :PStatistic:COUNTs?
Example	PST:COUN 5001 PST:COUN?
Couplings	This value is coupled to Meas Cycles. When Counts is changed, the MeasCycles value will be $(\text{Counts} / \text{SamplingFrequency} * \text{MeasInterval})$. TD-SCDMA: When Counts is changed, the MeasCycles value will be $(\text{Counts} / (\text{Sampling Frequency} * \text{Time duration of measured time slots} / 5 \text{ msec}))$, Time duration of measured time slots is determined by Analysis Time Slot and Measure Interval.
Preset	10000000
State Saved	Saved in instrument state.
Min	1000
Max	2000000000
Initial S/W Revision	Prior to A.02.00
Modified at S/W Revision	A.02.00, A.03.00
Default Unit	Kpt

Meas Cycles

Set the number of measurement cycles to calculate power statistic data. This number couples to Counts. The Counts value is $(\text{MeasCycles} * \text{Sampling Frequency} * \text{MeasInterval})$.

When the counts value cannot be divided by $(\text{Sampling Frequency} * \text{MeasInterval})$, this value is

Power Stat CCDF Measurement
Meas Setup

displayed as a decimal fraction.

Key Path	Meas Setup
Mode	SA, WCDMA, C2K, WiMAX OFDMA, TD-SCDMA, 1xEV-DO, DVB-T/H, DTMB (CTTB), ISDB-T, CMMB, LTE, LTETDD
Remote Command	[:SENSe] :PStatistic:SWEep:CYCLes <integer> [:SENSe] :PStatistic:SWEep:CYCLes?
Example	PST:SWE:CYCL 1001 PST:SWE:CYCL?
Notes	.
Couplings	The Counts value will be (MeasCycles * Sampling Frequency * MeasInterval). TD-SCDMA: The Counts value will be (MeasCycles * Sampling Frequency * Time duration of measured time slots / 5 msec), Time duration of measured time slots is determined by Analysis Time Slot and Measure Interval.
Preset	Depends on the sampling frequency.
Min	1
Max	Depends on the sampling frequency.
Initial S/W Revision	Prior to A.02.00
Modified at S/W Revision	A.02.00, A.03.00

Meas Interval (When the application is NOT CDMA1xEVDO)

Sets the number of data points to be used as the measurement interval. This value couples to Counts. The Counts value is (MeasCycles * Sampling Frequency * MeasInterval).

Key Path	Meas Setup
Mode	SA, WCDMA, C2K, WiMAX OFDMA, TD-SCDMA, 1xEV-DO, DVB-T/H, DTMB (CTTB), ISDB-T, CMMB, LTE, LTETDD
Remote Command	[:SENSe] :PStatistic:SWEep:TIME <time> [:SENSe] :PStatistic:SWEep:TIME?
Example	PST:SWE:TIME 2 ms PST:SWE:TIME?

Couplings	<p>The Counts value will be (MeasCycles * Sampling Frequency * MeasInterval).</p> <p>WiMAX OFDMA: The default value depends on Radio Device status.</p> <p>TD-SCDMA: The Counts value will be (MeasCycles * Sampling Frequency * Time duration of measured time slots / 5 msec), Time duration of measured time slots is determined by Analysis Time Slot and Measure Interval.</p> <p>When TriggerSource is RFBurst, this button is grayed.</p>
Preset	<p>Others: 1.0 ms</p> <p>TD-SCDMA: 1 slot</p>
Min	<p>Others: 50.0 us</p> <p>TD-SCDMA: 1 slot</p>
Max	<p>Others: 10.0 ms</p> <p>TD-SCDMA: 9 slot</p>
Initial S/W Revision	Prior to A.02.00
Modified at S/W Revision	A.02.00, A.03.00

Meas Interval (CDMA1xEVDO Only)

Sets the value of time to be used as the measurement interval. This value couples to Counts. The Counts value is (MeasCycles * Sampling Frequency * MeasInterval).

Key Path	Meas Setup
Mode	1xEV-DO
Remote Command	<p>[:SENSE] :PStatistic:SWEep:TIME <time></p> <p>[:SENSe] :PStatistic:SWEep:TIME?</p>
Example	<p>PST:SWE:TIME 2 ms</p> <p>PST:SWE:TIME?</p>
Couplings	The Counts value will be (MeasCycles * Sampling Frequency * MeasInterval).
Preset	182.29 us
State Saved	Saved in instrument state.
Min	1.0 us
Max	10.0 ms
Initial S/W Revision	Prior to A.02.00

Meas Offset (CDMA1xEVDO Only)

Sets the value of time to be used as the measurement interval start.

Key Path	Meas Setup
Mode	CDMA1xEVDO
Remote Command	[[:SENSE]:PStatistic:SWEep:OFFSet <time> [[:SENSE]:PStatistic:SWEep:OFFSet?
Example	PST:SWE:OFFS 2 ms PST:SWE:OFFS?
Preset	325.52 us
State Saved	Saved in instrument state.
Min	1.0 us
Max	10.0 ms
Initial S/W Revision	Prior to A.02.00

IF Gain

Sets the IF Gain function to Auto, Low Gain or High Gain. These settings affect sensitivity and IF overloads.

This only applies to the RF input. It does not apply to baseband I/Q input.

Key Path	Meas Setup
Initial S/W Revision	Prior to A.02.00

IF Gain Auto

Activates the Auto Rules for IF Gain When Auto is active, the IF Gain is set to High Gain under any of the following conditions:

- the input attenuator is set to 0 dB
- the preamp is turned On
- the Max Mixer Level is -20 dBm or lower

For other settings, Auto sets IF Gain to Off.

Key Path	Meas Setup, IF Gain
Mode	SA, WCDMA, C2K, WiMAX OFDMA, TD-SCDMA, 1xEV-DO, DVB-T/H, DTMB (CTTB), ISDB-T, CMMB, LTE, LTE-TDD

Remote Command	[:SENSE] :PStatistic:IF:GAIN:AUTO [:STATE] ON OFF 1 0 [:SENSE] :PStatistic:IF:GAIN:AUTO [:STATE] ?
Example	PST:IF:GAIN:AUTO ON PST:IF:GAIN:AUTO?
Notes	IF Gain only applies to the RF input. It does not apply to baseband I/Q input.
Couplings	When either the auto attenuation is active (for example, with electrical attenuator), or the optimize mechanical attenuator range is requested, the IF Gain setting is changed using the following rule. The Auto selection sets IF Gain On under any of the following conditions: <ul style="list-style-type: none"> • the input attenuator is set to 0 dB • the preamp is turned on, • the Max Mixer Level is -20 dBm or lower. For other settings, Auto sets IF Gain to Off.
Preset	OFF
State Saved	Saved in instrument state.
Range	Auto Man
Initial S/W Revision	Prior to A.02.00
Modified at S/W Revision	A.02.00, A.03.00

IF Gain State

Selects the range of IF gain. On sets the high gain option, which allows for better noise level measurements and Off sets low gain when measuring large signals.

Key Path	Meas Setup, IF Gain
Mode	SA, WCDMA, C2K, WIMAXOFDMA, TD-SCDMA, 1xEV-DO, DVB-T/H, DTMB (CTTB), ISDB-T, CMMB, LTE, LTETDD
Remote Command	[:SENSE] :PStatistic:IF:GAIN [:STATE] ON OFF 1 0 [:SENSE] :PStatistic:IF:GAIN [:STATE] ?
Example	PST:IF:GAIN ON PST:IF:GAIN?
Notes	IF Gain only applies to the RF input. It does not apply to baseband I/Q input. where ON = high gain OFF = low gain
Preset	OFF
State Saved	Saved in instrument state.

Power Stat CCDF Measurement
Meas Setup

Range	Low Gain (Best for Large Signals) High Gain (Best Noise Level)
Readback Text	Low Gain High Gain
Initial S/W Revision	Prior to A.02.00
Modified at S/W Revision	A.02.00, A.03.00

Meas Preset

Restores all measurement settings to their default values.

Key Path	Meas Setup
Mode	SA, WCDMA, C2K, WIMAXOFDMA, TD-SCDMA, 1xEV-DO, DVB-T/H, DTMB (CTTB), ISDB-T, CMMB, LTE, LTETDD
Remote Command	:CONFigure:PStatistic
Example	CONF:PST
Notes	You must be in the Spectrum Analysis mode, W-CDMA mode, cdma2000 mode, TD-SCDMA mode, DVB-T/H mode, DTMB (CTTB) mode, ISDB-T mode, CMMB mode or WIMAXOFDMA mode to use this command. Use :INSTrument:SElect to set the mode.
Couplings	Selecting Meas Preset will restore all measurement parameters to their default values.
Initial S/W Revision	Prior to A.02.00
Modified at S/W Revision	A.02.00, A.03.00

Mode

See [“Mode” on page 1123](#) in the "Common Measurement Functions" section for more information.

Mode Setup

See “[Mode Setup](#)” on page 1141 in the "Common Measurement Functions" section for more information.

Peak Search

There is no 'Peak Search' functionality supported in Power Stat CCD measurementF. The front-panel key will display a blank key menu when pressed.

Key Path	Front-panel key
Initial S/W Revision	Prior to A.02.00

Recall

See “[Recall](#)” on page 153 in the "Common Measurement Functions" section for more information.

Restart

See [“Restart” on page 1163](#) in the "Common Measurement Functions" section for more information.

Save

See [“Save” on page 170](#) in the "Common Measurement Functions" section for more information.

Single

See “[Single \(Single Measurement/Sweep\)](#)” on page 1169 in the "Common Measurement Functions" section for more information.

Source

See [“Source” on page 1171](#) in the "Common Measurement Functions" section for more information.

Span X Scale

The SPAN X Scale key accesses the menu to set the desired horizontal scale.

Key Path	Front-panel key
Initial S/W Revision	Prior to A.02.00

Scale/Div

Enables you to enter a time value to change the horizontal scale.

Key Path	Span X Scale
Mode	SA, WCDMA, C2K, WIMAXOFDMA, TD-SCDMA, 1xEV-DO, DVB-T/H, DTMB (CTTB), ISDB-T, CMMB, LTE, LTETDD
Remote Command	:DISPlay:PSTatistic:VIEW[1]:WINDow2:TRACe:X[:SCALe]:PDI Vision <rel_ampl> :DISPlay:PSTatistic:VIEW[1]:WINDow2:TRACe:X[:SCALe]:PDI Vision?
Example	DISP:PST:VIEW:WIND2:TRAC:X:PDIV 10 DISP:PST:VIEW:WIND2:TRAC:X:PDIV?
Notes	CCDF measurement has the trace display only at Window 2.
Couplings	See Notes
Preset	2.00
State Saved	Saved in instrument state.
Min	0.1
Max	20
Backwards Compatibility SCPI	:DISPlay:PSTatistic:XSCale
Initial S/W Revision	Prior to A.02.00
Modified at S/W Revision	A.02.00, A.03.00

Sweep/Control

Enables you to pause the power statistics CCDF measurement after the current data acquisition is complete. When Paused, the label on the menu key changes to Resume. Press the Resume key to resume the measurement where it was when it was paused.

Key Path	Front-panel key
Initial S/W Revision	Prior to A.02.00

Pause/Resume

Pauses a measurement after the current data acquisition is complete. When Paused, the label on the key changes to Resume. Press the Resume key to resume the measurement where it was when it was paused. See [“Pause/Resume” on page 1193](#) in the “Common Measurement Functions” section for details.

Key Path	Sweep/Control
Initial S/W Revision	Prior to A.02.00

Trace/Detector

Accesses a menu of functions that enable you to control the storage and manipulation of the reference trace, as well as controls the display of the trace data.

Key Path	Front-panel key
Initial S/W Revision	Prior to A.02.00

Store Ref Trace

Copies the currently measured curve as the user-definable reference trace. The captured data remains until the other mode is chosen. Pressing this key also refreshes the reference trace.

No query command is available.

Key Path	Trace/Detector
Mode	SA, WCDMA, C2K, WIMAXOFDMA, TD-SCDMA, 1xEV-DO, DVB-T/H, DTMB (CTTB), ISDB-T, CMMB, LTE, LTETDD
Remote Command	:CALCulate:PSTatistic:STORe:REFerence
Example	CALC:PST:STOR:REF
Backwards Compatibility SCPI	[:SENSe]:PSTatistic:SRTRace
Initial S/W Revision	Prior to A.02.00
Modified at S/W Revision	A.02.00, A.03.00

Ref Trace

Toggles the reference trace display between On and Off.

Key Path	Trace/Detector
Mode	SA, WCDMA, C2K, WIMAXOFDMA, TD-SCDMA, 1xEV-DO, DVB-T/H, DTMB (CTTB), ISDB-T, CMMB, LTE, LTETDD
Remote Command	:DISPlay:PSTatistic:RTRace[:STATe] OFF ON 0 1 :DISPlay:PSTatistic:RTRace[:STATe]?
Example	DISP:PST:RTR OFF DISP:PST:RTR?
Preset	OFF
State Saved	Saved in instrument state.
Range	On Off

Power Stat CCDF Measurement
Trace/Detector

Backwards Compatibility SCPI	[:SENSe]:PStatistic:RTRace[:STATe]
Initial S/W Revision	Prior to A.02.00
Modified at S/W Revision	A.02.00, A.03.00, A.04.00

Gaussian Line

Toggles the Gaussian trace display between On and Off.

Key Path	Trace/Detector
Mode	SA, WCDMA, C2K, WIMAXOFDMA, TD-SCDMA, 1xEV-DO, DVB-T/H, DTMB (CTTB), ISDB-T, CMMB, LTE, LTETDD
Remote Command	:DISPlay:PStatistic:GAUSSian[:STATe] OFF ON 0 1 :DISPlay:PStatistic:GAUSSian[:STATe]?
Example	DISP:PST:GAUS OFF DISP:PST:GAUS?
Preset	ON
State Saved	Saved in instrument state.
Range	On Off
Backwards Compatibility SCPI	[:SENSe]:PStatistic:GAUSSian[:STATe]
Initial S/W Revision	Prior to A.02.00
Modified at S/W Revision	A.02.00, A.03.00, A.04.00

Trigger

Accesses a menu of functions that enable you to select and control the trigger source for the current measurement. See [“Trigger” on page 1251](#) in the "Common Measurement Functions" section for more information.

View/Display

Accesses a menu of functions that enable you to control the instrument display as well as turn the bar graph On and Off.

The Power Stat CCDF measurement consists of single view. This is common for both Uplink (MS) and Downlink (BTS). The view consists of the following windows: Metrics (left) and graph display (right).

“Metrics window” on page 519

“Graph window” on page 520

“Wave window (TD-SCDMA and LTETDD only)” on page 520 and LTETDD only)

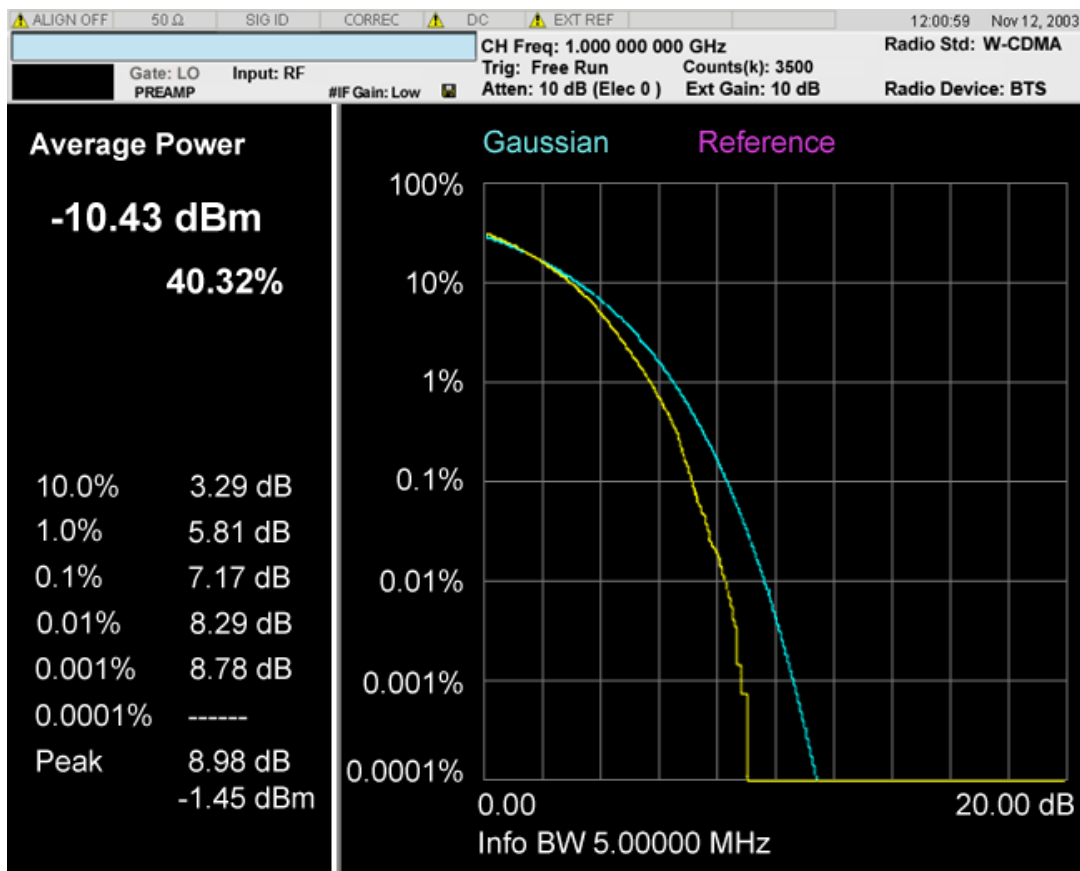

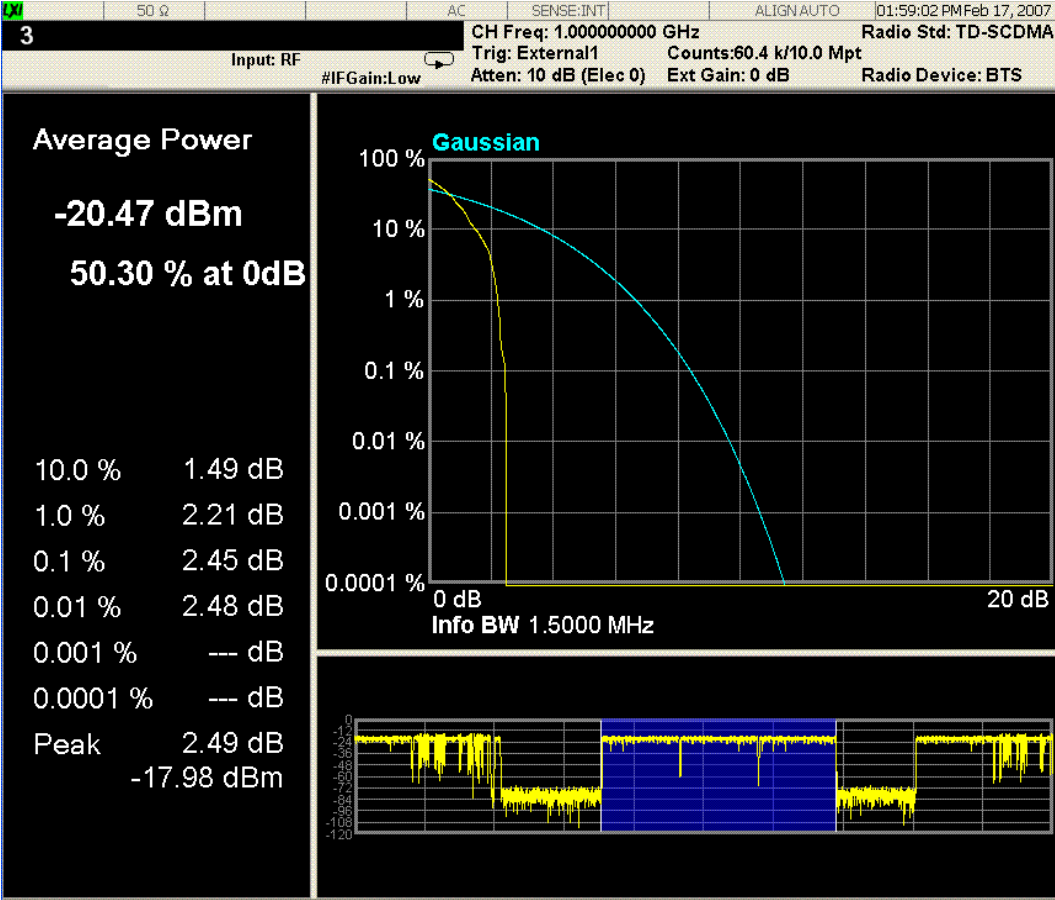

Metrics window

Name	Corresponding Results	Explanation
Average Power [dBm]	n=1 1st Average input power	99.99 dBm
Average Power [%]	n=1 2nd Probability at the average input power level	99.99 %
10.0% [dB]	n=1 3rd Power level that has 10% of the power	99.99 dB
1.0% [dB]	n=1 4th Power level that has 1% of the power	99.99 dB
0.1% [dB]	n=1 5th Power level that has 0.1% of the power	99.99 dB
0.01% [dB]	n=1 6th Power level that has 0.01% of the power	99.99 dB

Power Stat CCDF Measurement
View/Display

Name	Corresponding Results	Explanation
0.001% [dB]	n=1 7th Power level that has 0.001% of the power	99.99 dB
0.0001% [dB]	n=1 8th Power level that has 0.0001% of the power	99.99 dB
Peak [dB]	n=1 9th Peak power	99.99 dB
Peak[dBm]	This is not available using remote commands.	99.99 dBm

Graph window

Marker Operation	Yes
Corresponding Trace	<p>Yellow: Series of 5001 floating the current measured power stat trace. (n=2) Initially all markers refer this trace.</p> <p>Light Blue: Series of 5001 floating point numbers (in percent) that represent the Gaussian trace. (n=3)</p> <p>Violet: series of 5001 floating point numbers (in percent) that represent the user-definable reference trace. (n=4)</p> <p>The Gaussian and Reference trace/line can be removed using the features under the Trace/Detector key</p>

Wave window (TD-SCDMA and LTETDD only)

This window is only available under TD-SCDMA mode and LTETDD mode, and by default this window is closed, it could be turn of/off by soft key "SlotView", refer to section "[Slot View \(TD-SCDMA only\)](#)" on page 521.

Marker Operation	No
Corresponding Trace	<p>Yellow: For TD-SCDMA, Wave form of entire TD-SCDMA frame. If measurement range specified by Analysis Time Slot and Measured Time Slot is out of the first frame, the display range will extend to two TD-SCDMA frames. For LTETDD, Waveform of 2 continuous LTE type2 frames.</p> <p>Blue: Indicate current measurement range</p>

Key Path	Front-panel key
Initial S/W Revision	Prior to A.02.00

Display

Accesses a menu of functions that enable you to set the display parameters...

See “Display” on page 1313 in the "Common Measurement Functions" section for more information.

Key Path	View/Display
Initial S/W Revision	Prior to A.02.00

Slot View (TD-SCDMA only)

Switch between normal CCDF view and Slot view with additional wave window, this is available only under TD-SCDMA mode.

Key Path	View/Display
Mode	TD-SCDMA
Remote Command	[:SENSE] :PStatistic:SLTView[:STATE] OFF ON 0 1 [:SENSE] :PStatistic: SLTView[:STATE] ?
Example	PST:SLTV OFF PST:SLTV?
Preset	OFF
State Saved	Saved in instrument state.
Range	On Off
Initial S/W Revision	Prior to A.02.00

The spectrum emission mask measures spurious signal levels in up to six pairs of offset frequencies and relates them to the carrier power. For measurement results and views, see [“View/Display” on page 612](#).

This topic contains the following sections:

[“Measurement Commands for Spectrum Emission Mask” on page 523](#)

[“Remote Command Results for Spectrum Emission Mask Measurement” on page 524](#)

Measurement Commands for Spectrum Emission Mask

Offsets that are turned off (inactive) will return -999.0 when their results are queried over SCPI.

`:CONFigure:SEMask`

`:CONFigure:SEMask:NDEFault`

`:INITiate:SEMask`

`:FETCh:SEMask [n] ?`

`:MEASure:SEMask [n] ?`

`:READ:SEMask [n] ?`

For more measurement related commands, see the SENSE subsystem, and the section [“Remote Measurement Functions” on page 1083](#).

Remote Command Results for Spectrum Emission Mask Measurement

Command		Return Value
FETCh:SEMask[n]? MEASure:SEMask[n]? READ:SEMask[n]?	N=1	In case the Meas Type is: Total Power Reference Returns 82 comma-separated scalar results, in the following order: 1. Reserved for the future use, returns –999.0 2. Absolute power at the center frequency (reference) area (dBm) 3. Reserved for the future use, returns –999.0 4. Reserved for the future use, returns –999.0 5. Peak frequency in the center frequency (reference) area (Hz) 6. Reserved for the future use, returns –999.0 7. Reserved for the future use, returns –999.0 8. Reserved for the future use, returns –999.0 9. Reserved for the future use, returns –999.0 10. Reserved for the future use, returns –999.0 11. Relative integrated power on the negative offset A (dBc) 12. Absolute integrated power on the negative offset A (dBm) 13. Relative peak power on the negative offset A (dBc) 14. Absolute peak power on the negative offset A (dBm) 15. Peak power offset frequency from the center or carrier edge frequency in the negative offset A, depending on Offset Frequency Define settings (Hz) 16. Relative integrated power on the positive offset A (dBc) 17. Absolute integrated power on the positive offset A (dBm) 18. Relative peak power on the positive offset A (dBc) 19. Absolute peak power on the positive offset A (dBm) 20. Peak power offset frequency from the center or carrier edge frequency in the positive offset A, depending on Offset Frequency Define settings (Hz) 21. Relative integrated power on the negative offset B (dBc) ... 69. Absolute peak power on the positive offset F (dBm) 70. Peak power offset frequency from the center or carrier edge frequency in the positive offset F, depending on Offset Frequency Define settings (Hz)

Command		Return Value
	N=1	71. Minimum margin from limit line on the negative offset A (dB) 72. Minimum margin from limit line on the positive offset A (dB) 73. Minimum margin from limit line on the negative offset B (dB) 74. Minimum margin from limit line on the positive offset B (dB) 75. Minimum margin from limit line on the negative offset C (dB) 76. Minimum margin from limit line on the positive offset C (dB) 77. Minimum margin from limit line on the negative offset D (dB) 78. Minimum margin from limit line on the positive offset D (dB) 79. Minimum margin from limit line on the negative offset E (dB) 80. Minimum margin from limit line on the positive offset E (dB) 81. Minimum margin from limit line on the negative offset F (dB) 82. Minimum margin from limit line on the positive offset F (dB)

Command		Return Value
	N=1	<p>In case the Meas Type is: Power Spectral Density Reference</p> <p>Returns 82 comma-separated scalar results, in the following order:</p> <ol style="list-style-type: none"> 1. Reserved for the future use, returns -999.0 2. Absolute power at the center frequency (reference) area (dBm/Hz) 3. Reserved for the future use, returns -999.0 4. Reserved for the future use, returns -999.0 5. Peak frequency in the center frequency (reference) area (Hz) 6. Reserved for the future use, returns -999.0 7. Reserved for the future use, returns -999.0 8. Reserved for the future use, returns -999.0 9. Reserved for the future use, returns -999.0 10. Reserved for the future use, returns -999.0 11. Relative integrated power on the negative offset A (dB). 12. Absolute integrated power on the negative offset A (dBm/Hz). 13. Relative peak power on the negative offset A (dB) 14. Absolute peak power on the negative offset A (dBm/Hz) 15. Peak power offset frequency from the center or carrier edge frequency in the negative offset A, depending on Offset Frequency Define settings (Hz) 16. Relative integrated power on the positive offset A (dB). 17. Absolute integrated power on the positive offset A (dBm/Hz). 18. Relative peak power on the positive offset A (dB) 19. Absolute peak power on the positive offset A (dBm/Hz) 20. Peak power offset frequency from the center or carrier edge frequency in the positive offset A, depending on Offset Frequency Define settings (Hz) 21. Relative integrated power on the negative offset B (dB). ... 69. Absolute peak power on the positive offset F (dBm/Hz) 70. Peak power offset frequency from the center or carrier edge frequency in the positive offset F, depending on Offset Frequency Define settings (Hz)

Command		Return Value
	N=1	71. Minimum margin from limit line on the negative offset A (dB) 72. Minimum margin from limit line on the positive offset A (dB) 73. Minimum margin from limit line on the negative offset B (dB) 74. Minimum margin from limit line on the positive offset B (dB) 75. Minimum margin from limit line on the negative offset C (dB) 76. Minimum margin from limit line on the positive offset C (dB) 77. Minimum margin from limit line on the negative offset D (dB) 78. Minimum margin from limit line on the positive offset D (dB) 79. Minimum margin from limit line on the negative offset E (dB) 80. Minimum margin from limit line on the positive offset E (dB) 81. Minimum margin from limit line on the negative offset F (dB) 82. Minimum margin from limit line on the positive offset F (dB)

Command		Return Value
	N=1	<p>In case the Meas Type is: Spectrum Peak Reference</p> <p>Returns 82 comma-separated scalar results, in the following order:</p> <ol style="list-style-type: none"> 1. Reserved for the future use, returns –999.0 2. Peak power at the center frequency (reference) area (dBm) 3. Reserved for the future use, returns –999.0 4. Reserved for the future use, returns –999.0 5. Peak frequency in the center frequency (reference) area (Hz) 6. Reserved for the future use, returns –999.0 7. Reserved for the future use, returns –999.0 8. Reserved for the future use, returns –999.0 9. Reserved for the future use, returns –999.0 10. Reserved for the future use, returns –999.0 11. Reserved for the future use, returns –999.0 12. Reserved for the future use, returns –999.0 13. Relative peak power on the negative offset A (dB) 14. Absolute peak power on the negative offset A (dBm) 15. Peak power offset frequency from the center or carrier edge frequency in the negative offset A, depending on Offset Frequency Define settings (Hz) 16. Reserved for the future use, returns –999.0 17. Reserved for the future use, returns –999.0 18. Relative peak power on the positive offset A (dB) 19. Absolute peak power on the positive offset A (dBm) 20. Peak power offset frequency from the center or carrier edge frequency in the positive offset A, depending on Offset Frequency Define settings (Hz) 21. Reserved for the future use, returns –999.0 ... 69. Absolute peak power on the positive offset F (dBm) 70. Peak power offset frequency from the center or carrier edge frequency in the positive offset F, depending on Offset Frequency Define settings (Hz)

Command		Return Value
	N=1	71. Minimum margin from limit line on the negative offset A (dB) 72. Minimum margin from limit line on the positive offset A (dB) 73. Minimum margin from limit line on the negative offset B (dB) 74. Minimum margin from limit line on the positive offset B (dB) 75. Minimum margin from limit line on the negative offset C (dB) 76. Minimum margin from limit line on the positive offset C (dB) 77. Minimum margin from limit line on the negative offset D (dB) 78. Minimum margin from limit line on the positive offset D (dB) 79. Minimum margin from limit line on the negative offset E (dB) 80. Minimum margin from limit line on the positive offset E (dB) 81. Minimum margin from limit line on the negative offset F (dB) 82. Minimum margin from limit line on the positive offset F (dB)
	N=2	Returns the displayed frequency domain spectrum trace data separated by comma. The number of data is 2001.
	N=3	Returns the displayed frequency domain absolute limit trace data separated by comma. The number of data is determined 2001.
	N=4	Returns the displayed frequency domain relative limit trace data separated by comma. The number of data is 2001.
	N=5	In case the Meas Type is: Total Power Reference Returns 14 comma-separated scalar values (in dBm) of the absolute integrated power of the segment frequencies: 1. Total power reference (dBm) 2. Reserved for the future use, returns -999.0 3. Absolute integrated power at negative offset frequency (A) 4. Absolute integrated power at positive offset frequency (A) ... 13. Absolute integrated power at negative offset frequency (F) 14. Absolute integrated power at positive offset frequency (F)

Command		Return Value
	N=5	<p>In case the Meas Type is: Power Spectral Density Reference</p> <p>Returns 14 comma-separated scalar values (in dBm/Hz) of the absolute integrated power of the segment frequencies. Returns -999.0 for the offsets if in WLAN:</p> <ol style="list-style-type: none"> 1. Power spectral density reference (dBm/Hz) 2. Reserved for the future use, returns -999.0 3. Absolute integrated power at negative offset frequency (A) 4. Absolute integrated power at positive offset frequency (A) ... 13. Absolute integrated power at negative offset frequency (F) 14. Absolute integrated power at positive offset frequency (F)
	N=5	<p>In case the Meas Type is: Spectrum Peak Reference</p> <p>Returns 14 comma-separated scalar values (in dBm) of the absolute peak power of the segment frequencies.</p> <ol style="list-style-type: none"> 1. Spectrum Peak Power reference (dBm) 2. Reserved for the future use, returns -999.0 3. Absolute peak power at negative offset frequency (A) 4. Absolute peak power at positive offset frequency (A) ... 13. Absolute peak power at negative offset frequency (F) 14. Absolute peak power at positive offset frequency (F)
	N=6	<p>In case the Meas Type is: Total Power Reference</p> <p>Returns 14 comma-separated scalar values (in dBc) of the integrated power relative to the carrier at the segment frequencies:</p> <ol style="list-style-type: none"> 1. Reserved for the future use, returns -999.0 2. Reserved for the future use, returns -999.0 3. Relative integrated power at negative offset frequency (A) 4. Relative integrated power at positive offset frequency (A) ... 13. Relative integrated power at negative offset frequency (F) 14. Relative integrated power at positive offset frequency (F)

Command		Return Value
	N=6	<p>In case the Meas Type is: Power Spectral Density Reference</p> <p>Returns 14 comma-separated scalar values (in dBc/Hz) of the integrated power relative to the carrier at the segment frequencies. Returns -999.0 for the offsets if in WLAN:</p> <ol style="list-style-type: none"> 1. Reserved for the future use, returns -999.0 2. Reserved for the future use, returns -999.0 3. Relative integrated power at negative offset frequency (A) 4. Relative integrated power at positive offset frequency (A) ... 13. Relative integrated power at negative offset frequency (F) 14. Relative integrated power at positive offset frequency (F)
	N=6	<p>In case the Meas Type is: Spectrum Peak Reference</p> <p>Returns 14 comma-separated scalar values (in dB) of the integrated power relative to the carrier at the segment frequencies.</p> <ol style="list-style-type: none"> 1. Reserved for the future use, returns -999.0 2. Reserved for the future use, returns -999.0 3. Relative peak power at negative offset frequency (A) 4. Relative peak power at positive offset frequency (A) ... 13. Relative peak power at negative offset frequency (F) 14. Relative peak power at positive offset frequency (F)
	N=7	<p>Returns 14 comma-separated pass/fail test results (0=passed, or 1=failed) determined by testing the minimum margin point from the limit line that is determined each offset's Limits setting.</p> <ol style="list-style-type: none"> 1. Reserved for the future use, returns -999.0 2. Reserved for the future use, returns -999.0 3. At negative offset frequency (A) 4. At positive offset frequency (A) ... 13. At negative offset frequency (F) 14. At positive offset frequency (F)

Command		Return Value
	N=8	<p>Returns 14 comma-separated pass/fail test results (0=passed, or 1=failed) determined by testing the minimum margin point from the limit line that is determined each offset's Limits setting.</p> <hr/> <p>NOTE This results (N=8) are the same as N=7 result.</p> <hr/> <ol style="list-style-type: none"> 1. Reserved for the future use, returns -999.0 2. Reserved for the future use, returns -999.0 3. At negative offset frequency (A) 4. At positive offset frequency (A) ... 13. At negative offset frequency (F) 14. At positive offset frequency (F)
	N=9	<p>Returns 14 comma-separated scalar values of frequency (in Hz) that have peak power from center or carrier edge frequency in each offset, depending on Offset Frequency Define settings.</p> <ol style="list-style-type: none"> 1. Reserved for the future use, returns -999.0 2. Reserved for the future use, returns -999.0 3. Negative offset frequency (A) 4. Positive offset frequency (A) ... 13. Negative offset frequency (F) 14. Positive offset frequency (F)
	N=10	<p>Returns 14 comma-separated scalar values (in dBm) of the absolute peak power of the segment frequencies:</p> <ol style="list-style-type: none"> 1. Reserved for the future use, returns -999.0 2. Reserved for the future use, returns -999.0 3. At negative offset frequency (A) 4. At positive offset frequency (A) ... 13. At negative offset frequency (F) 14. At positive offset frequency (F)

Command		Return Value
	N=11	Returns 14 comma-separated scalar values in dBc (dB if MeasType = PSD) of the peak power relative to the carrier at the segment frequencies: <ol style="list-style-type: none"> 1. Reserved for the future use, returns -999.0 2. Reserved for the future use, returns -999.0 3. At negative offset frequency (A) 4. At positive offset frequency (A) ... 13. At negative offset frequency (F) 14. At positive offset frequency (F)
	N=12	Returns the power result (the peak power of the signal in the ref channel) when Meas Type is Spectrum Peak reference. Otherwise, the value returned will be -999.0

Key Path	Meas
Initial S/W Revision	Prior to A.02.00

AMPTD Y Scale

Accesses a menu of functions that enable you to set the vertical scale parameters. The parameter values are measurement independent except all Attenuation values and Internal Preamp selections that are measurement global.

Key Path	Front-panel key
Initial S/W Revision	Prior to A.02.00

Ref Value

Sets the value for the absolute power reference. However, since the Auto Scaling is defaulted to On, this value is automatically determined by the measurement result. When you set a value manually, Auto Scaling automatically changes to Off.

Key Path	AMPTD Y Scale
Mode	SA, WCDMA, C2K, WIMAX OFDMA, TD-SCDMA, 1xEVDO, DTMB (CTTB), DVB-T/H, ISDB-T, CMMB, LTE, LTETDD
Remote Command	:DISPlay:SEMask:VIEW[1]:WINDow[1]:TRACe:Y[:SCALe]:RLEVe l <real> :DISPlay:SEMask:VIEW[1]:WINDow[1]:TRACe:Y[:SCALe]:RLEVe l?
Example	DISP:SEM:VIEW:WIND:TRAC:Y:RLEV 100 DISP:SEM:VIEW:WIND:TRAC:Y:RLEV?
Notes	You must be in the Spectrum Analysis mode, W-CDMA mode, cdma2000 mode, TD-SCDMA mode, DTMB (CTTB) mode, DVB-T/H mode, ISDB-T mode, CMMB mode, LTE mode, LTE TDD mode, 1xEVDO mode or WIMAX OFDMA mode to use this command. Use :INSTrument:SELEct to set the mode.
Couplings	When the Auto Scaling is On, this value is automatically determined by the measurement result. When you set a value manually, Auto Scaling automatically changed to Off.
Preset	All except CDMA1xEVDO:10.0 dBm CDMA1xEVDO: -10.0dBm
State Saved	Saved in instrument state.
Min	-250 dBm
Max	250 dBm
Initial S/W Revision	Prior to A.02.00
Modified at S/W Revision	A.02.00, A.03.00

Attenuation

Accesses a menu of functions that enable you to change attenuation settings. This key has read-back text that describes the total attenuator value.

See AMPTD Y Scale, “Attenuation” on page 910 in the “Common Measurement Functions” section for more information.

Scale/Div

Sets the units-per-division of the vertical scale in the logarithmic display. When Auto Scaling is On, the scale per division value is automatically determined by the measurement result. When you set a value manually, Auto Scaling automatically changes to Off.

Key Path	AMPTD Y Scale
Mode	SA, WCDMA, C2K, WIMAX OFDMA, TD-SCDMA, 1xEVDO, DTMB (CTTB), DVB-T/H, ISDB-T, CMMB, LTE, LTETDD
Remote Command	:DISPlay:SEMask:VIEW[1]:WINDow[1]:TRACe:Y[:SCALe]:PDIVi sion <rel_ampl> :DISPlay:SEMask:VIEW[1]:WINDow[1]:TRACe:Y[:SCALe]:PDIVi sion?
Example	DISP:SEM:VIEW:WIND:TRAC:Y:PDIV 15dB DISP:SEM:VIEW:WIND:TRAC:Y:PDIV?
Notes	You must be in the Spectrum Analysis mode, W-CDMA mode, cdma2000 mode, TD-SCDMA mode, DTMB (CTTB) mode, DVB-T/H mode, ISDB-T mode, CMMB mode, LTE mode, LTE TDD mode, 1xEVDO mode or WIMAX OFDMA mode to use this command. Use :INSTrument:SElect to set the mode.
Couplings	When the Auto Scaling is On, this value is automatically determined by the measurement result. When you set a value manually, Auto Scaling automatically changes to Off.
Preset	10 dB
State Saved	Saved in instrument state.
Min	0.10 dB
Max	20.00 dB
Initial S/W Revision	Prior to A.02.00
Modified at S/W Revision	A.02.00, A.03.00

Presel Center

See AMPTD Y Scale, “Presel Center” on page 926 in the “Common Measurement Functions” section for more information.

Presel Adjust

See AMPTD Y Scale, “[Preselector Adjust](#)” on page 927 in the “Common Measurement Functions” section for more information.

Y Axis Unit

Allows you to change the vertical (Y) axis amplitude unit.

See “[Y Axis Unit](#)” on page 929 under AMPTD Y Scale in the "Common Measurement Functions" section for more information.

Parameter Name	Y Axis Unit
Key Path	AMPTD Y Scale
Initial S/W Revision	A.04.00

Reference Level Offset

Adds an offset value to the displayed reference level. The reference level is the absolute amplitude represented by the top graticule line on the display.

See “[Reference Level Offset](#)” on page 934 under AMPTD Y Scale in the "Common Measurement Functions" section for more information.

Parameter Name	Reference Level Offset
Key Path	AMPTD Y Scale
Initial S/W Revision	A.04.00

μ W Path Control

The **μ W Path Control** functions include the **μ W Preselector Bypass** (Option MPB) and **Low Noise Path** (Option LNP) controls in the High Band path circuits.

See μ “ [\$\mu\$ W Path Control](#)” on page 935 under AMPTD Y Scale in the "Common Measurement Functions" section for more information.

Parameter Name	μ W Path Control
Key Path	AMPTD Y Scale
Initial S/W Revision	A.04.00

Internal Preamp

Accesses a menu of functions that enable you to control the internal preamplifiers.

See AMPTD Y Scale, “[Internal Preamp](#)” on page 939 in the “Common Measurement Functions” section for more information.

Ref Position

Positions the reference level at the top, center or bottom of the Y scale display. Changing the reference position does not affect the reference level value.

Key Path	AMPTD Y Scale
Mode	SA, WCDMA, C2K, WIMAX OFDMA, TD-SCDMA, 1xEVDO, DTMB (CTTB), DVB-T/H, ISDB-T, CMMB, LTE, LTETDD
Remote Command	:DISPlay:SEMask:VIEW[1]:WINDow[1]:TRACe:Y[:SCALe]:RPOSi tion TOP CENTer BOTTom :DISPlay:SEMask:VIEW[1]:WINDow[1]:TRACe:Y[:SCALe]:RPOSi tion?
Example	DISP:SEM:VIEW:WIND:TRAC:Y:RPOS BOTT DISP:SEM:VIEW:WIND:TRAC:Y:RPOS?
Notes	You must be in the Spectrum Analysis mode, W-CDMA mode, cdma2000 mode, TD-SCDMA mode, DTMB (CTTB) mode, DVB-T/H mode, ISDB-T mode, CMMB mode, LTE mode, LTE TDD mode, 1xEVDO mode or WIMAX OFDMA mode to use this command. Use INSTRument:SElect to set the mode.
Preset	TOP
State Saved	Saved in instrument state.
Range	Top Ctr Bot
Initial S/W Revision	Prior to A.02.00
Modified at S/W Revision	A.02.00, A.03.00

Auto Scaling

Toggles the Auto Scaling function between On and Off.

When Auto Scaling is On and the Restart front-panel key is pressed, the analyzer automatically determines the scale per division and reference values based on the measurement results. When you set a value to either Scale/Div or Ref Value manually, Auto Scaling automatically changes to Off.

Key Path	AMPTD Y Scale
Mode	SA, WCDMA, C2K, WIMAX OFDMA, TD-SCDMA, 1xEVDO, DTMB (CTTB), DVB-T/H, ISDB-T, CMMB, LTE, LTETDD
Remote Command	:DISPlay:SEMask:VIEW[1]:WINDow[1]:TRACe:Y[:SCALe]:COUPl e 0 1 ON OFF :DISPlay:SEMask:VIEW[1]:WINDow[1]:TRACe:Y[:SCALe]:COUPl e?

Spectrum Emission Mask Measurement
AMPTD Y Scale

Example	DISP:SEM:VIEW:WIND:TRAC:Y:COUP OFF DISP:SEM:VIEW:WIND:TRAC:Y:COUP?
Notes	You must be in the Spectrum Analysis mode, W-CDMA mode, cdma2000 mode, TD-SCDMA, DTMB (CTTB) mode, DVB-T/H mode, ISDB-T mode, CMMB mode, LTE mode, LTE TDD mode, 1xEVDO mode or WIMAX OFDMA mode to use this command. Use :INSTrument:SElect to set the mode.
Couplings	When Auto Scaling is On, upon pressing the Restart front-panel key, this function automatically determines the scale per division and reference values based on the measurement results. When you set a value to either Scale/Div or Ref Value manually, Auto Scaling automatically changes to Off.
Preset	ON
State Saved	Saved in instrument state.
Range	On Off
Initial S/W Revision	Prior to A.02.00
Modified at S/W Revision	A.02.00, A.03.00

Auto Couple

See [“Auto Couple” on page 943](#) in the section "Common Measurement Functions" for more information.

BW

Accesses a menu of functions that enable you to select the type of filter for the measurement.

Key Path	Front-panel key
Initial S/W Revision	Prior to A.02.00
Modified at S/W Revision	A.03.00

Filter Type

Selects the type of bandwidth filter that is used in Carrier and Offsets.

When Gaussian or Flattop is selected, selected filter is applied to carriers and all offsets.

When Auto Sense is selected, filter type is automatically selected for each carriers and offsets, so that measurement speed and accuracy is optimized.

Key Path	BW
Mode	SA, WCDMA, C2K, WIMAX OFDMA, TD-SCDMA, 1xEVDO, DVB-T/H, DTMB (CTTB), ISDB-T, CMMB, LTE, LTETDD
Remote Command	[:SENSe] :SEMAsk:BA NDwidth:SHAPE ASENSe GAUSSian FLATtop [:SENSe] :SEMAsk:BA NDwidth:SHAPE?
Example	SEM:BA ND:SHAPE GAUS SEM:BA ND:SHAPE?
Couplings	See the description above
Preset	ASENSe
State Saved	Saved in instrument state.
Range	Auto Sense (each offset and carrier) Gaussian (all offsets and carriers) Flattop (all offsets and carriers)
Initial S/W Revision	A.03.00

Cont

See “[Cont \(Continuous Measurement/Sweep\)](#)” on page 957 in the section "Common Measurement Functions" for more information.

FREQ Channel

See “[FREQ Channel](#)” on page 959 in the section "Common Measurement Functions" for more information.

Input/Output

See “[Input/Output](#)” on page 969 in the section "Common Measurement Functions" for more information.

Marker

Accesses a menu that enables you to select, set up and control the markers for the current measurement. If there are no active markers, **Marker** selects marker 1, sets it to Normal and places it at the center of the display. You can turn on and control up to 12 markers.

Key Path	Front-panel key
Initial S/W Revision	Prior to A.02.00

Select Marker

Displays 12 markers available for selection.

Key Path	Marker
Initial S/W Revision	Prior to A.02.00

Marker Type

Sets the marker control mode to Normal and Off. If the selected marker is Off, pressing Marker sets it to Normal and places it at the center of the screen on the trace determined by the **Marker Trace** rules. At the same time, **Marker X Axis Value** appears on the Active Function area. The marker X axis value entered in the active function area will display the marker value to its full entered precision. If the current control mode for the measurement is Off, there is no active function and the active function is turned off.

Key Path	Marker
Mode	SA, WCDMA, C2K, WIMAX OFDMA, TD-SCDMA, 1xEVDO, DTMB (CTTB), DVB-T/H, ISDB-T, CMMB, LTE, LTETDD
Remote Command	:CALCulate:SEMAsk:MARKer [1] 2 3 4 5 6 7 8 9 10 11 12 :MO DE POSition OFF :CALCulate:SEMAsk:MARKer [1] 2 3 4 5 6 7 8 9 10 11 12 :MO DE?
Example	CALC:SEM:MARK:MODE POS CALC:SEM:MARK:MODE?
Notes	If the selected marker is Off, pressing Marker sets it to Normal and places it at the center of the screen on the trace determined by the Marker Trace rules. At the same time, Marker X Axis Value appears on the Active Function area. Default Active Function: the active function for the selected marker's current control mode. Note that if the current control mode is Off, there is no active function and the active function is turned off. Active Function Display: the marker X axis value entered in the active function area will display the marker value to its full entered precision.

Preset	OFF OFF OFF OFF OFF OFF OFF OFF OFF OFF OFF OFF
State Saved	Saved in instrument state.
Range	Normal Off
Initial S/W Revision	Prior to A.02.00
Modified at S/W Revision	A.02.00, A.03.00

Marker X Axis Value (Remote Command only)

Sets the marker X Axis value in the current marker X Axis Scale unit. It has no effect if the control mode is Off, but is the SCPI equivalent of entering an X value if the control mode is **Normal**.

Mode	SA, WCDMA, C2K, WIMAX OFDMA, TD-SCDMA, 1xEVDO, DTMB (CTTB), DVB-T/H ISDB-T, CMMB, LTE, LTETDD
Remote Command	:CALCulate:SEMask:MARKer [1] 2 3 4 5 6 7 8 9 10 11 12 : X <freq> :CALCulate:SEMask:MARKer [1] 2 3 4 5 6 7 8 9 10 11 12 : X?
Example	CALC:SEM:MARK3:X 1.0 GHz CALC:SEM:MARK3:X?
Notes	If no suffix is sent it will use the fundamental units for the current marker X Axis Scale. If a suffix is sent that does not match the current marker X Axis Scale unit, an error “Invalid suffix” will be generated. The query returns the marker’s absolute X Axis value if the control mode is Normal . The query is returned in the fundamental units for the current marker X Axis scale. If the marker is Off the response is not a number. When a Marker is turned on, it is placed center of the screen on the trace. Therefore the default value depends on instrument condition, although the Preset/Default is defined as 1.5 GHz.
Preset	After a preset, all Markers are turned OFF, so a Marker X Axis Value query will return a not a number (NAN).
State Saved	No
Min	-9.9E+37
Max	9.9E+37
Initial S/W Revision	Prior to A.02.00
Modified at S/W Revision	A.02.00, A.03.00

Marker X Axis Position (Remote Command only)

Sets the marker X position in trace points. It has no effect if the control mode is **Off**, but is the SCPI equivalent of entering a value if the control mode is **Normal**, except in trace points rather than X Axis Scale units. The entered value is immediately translated into the current X Axis Scale units for setting

Spectrum Emission Mask Measurement
Marker

the value of the marker.

Mode	SA, WCDMA, C2K, WIMAX OFDMA, TD-SCDMA, 1xEVDO, DTMB (CTTB), DVB-T/H, ISDB-T, CMMB, LTE, LTETDD
Remote Command	:CALCulate:SEMask:MARKer [1] 2 3 4 5 6 7 8 9 10 11 12 : X : POSition <real> :CALCulate:SEMask:MARKer [1] 2 3 4 5 6 7 8 9 10 11 12 : X : POSition?
Example	CALC:SEM:MARK10:X:POS 1001 CALC:SEM:MARK10:X:POS?
Notes	The query returns the marker's absolute X Axis value in trace points if the control mode is Normal . The value is returned as a real number, not an integer, corresponding to the translation from X Axis Scale units to trace points . If the marker is Off the response is not a number. When a Marker is turned on, it is placed center of the screen on the trace. Therefore the default value depends on he instrument condition although the Preset/Default is defined as 6507 (this value might be the expected value when all the offsets are on).
Preset	After a preset, all Markers are turned OFF, so a Marker X Axis Value query will return a not a number (NAN).
State Saved	No
Min	-9.9E+37
Max	9.9E+37
Initial S/W Revision	Prior to A.02.00
Modified at S/W Revision	A.02.00, A.03.00

Marker Y Axis Value (Remote Command only)

Returns the marker Y Axis value in the current marker Y Axis unit.

Mode	SA, WCDMA, C2K, WIMAX OFDMA, TD-SCDMA, 1xEVDO, DTMB (CTTB), DVB-T/H, ISDB-T, CMMB, LTE, LTETDD
Remote Command	:CALCulate:SEMask:MARKer [1] 2 3 4 5 6 7 8 9 10 11 12 : Y ?
Example	CALC:SEM:MARK11:Y 10 dBm CALC:SEM:MARK11:Y?
Notes	Since the result value is always calculated from acquisition data, the default value is arbitrary, although the Preset/Default values is defined.
Preset	Result dependent on markers setup and signal source
State Saved	No

Backwards Compatibility SCPI	:CALCulate:SEMask:MARKer[1] 2 3 4 5 6 7 8 9 10 11 12:FUNCTION:RESult?
Initial S/W Revision	Prior to A.02.00
Modified at S/W Revision	A.02.00, A.03.00

Couple Markers

When this function is true, moving any marker causes an equal X Axis movement of every other marker which is not **Off**. By “equal X Axis movement” we mean that we preserve the difference between each marker’s X Axis value (in the fundamental x-axis units of the trace that marker is on) and the X Axis value of the marker being moved (in the same fundamental x-axis units).

Key Path	Marker
Mode	SA, WCDMA, C2K, WIMAX OFDMA, TD-SCDMA, 1xEVDO, DTMB (CTTB), DVB-T/H, ISDB-T, CMMB, LTE, LTETDD
Remote Command	:CALCulate:SEMask:MARKer:COUPle[:STATe] ON OFF 1 0 :CALCulate:SEMask:MARKer:COUPle[:STATe]?
Example	CALC:SEM:MARK:COUP ON CALC:SEM:MARK:COUP?
Preset	OFF
State Saved	Saved in instrument state.
Range	On Off
Initial S/W Revision	Prior to A.02.00
Modified at S/W Revision	A.02.00, A.03.00

All Markers Off

Turns all active markers off in all views.

Key Path	Marker
Mode	SA, WCDMA, C2K, WIMAX OFDMA, TD-SCDMA, 1xEVDO, DTMB (CTTB), DVB-T/H, ISDB-T, CMMB, LTE, LTETDD
Remote Command	:CALCulate:SEMask:MARKer:AOFF
Example	CALC:SEM:MARK:AOFF
Initial S/W Revision	Prior to A.02.00
Modified at S/W Revision	A.02.00, A.03.00

Marker Function

There are no 'Marker Functions' supported in Spectrum Emission Mask so this front-panel key will display a blank key menu when pressed.

Key Path	Front-panel key
Initial S/W Revision	Prior to A.02.00

Marker To

There is no 'Marker To' functionality supported in Spectrum Emission Mask so this front-panel key will display a blank key menu when pressed.

Key Path	Front-panel key
Initial S/W Revision	Prior to A.02.00

Meas

See “[Meas](#)” on page 1083 in the section "Common Measurement Functions" for more information.

Meas Setup

Displays the setup menu for the currently selected measurement.

Key Path	Front-panel key
Initial S/W Revision	Prior to A.02.00

Avg/Hold Num

Toggles averaging On or Off in addition to enabling you to set the number of measurement averages used to calculate the measurement result. The average will be displayed at the end of each sweep. After the specified number of average counts, the average mode (termination control) setting determines the average action.

In the remote mode, use the Average State command to turn averaging on or off.

Key Path	Meas Setup
Mode	SA, WCDMA, C2K, WIMAX OFDMA, TD-SCDMA, 1xEVDO, DTMB (CTTB), DVB-T/H, ISDB-T, CMMB, LTE, LTETDD
Remote Command	[:SENSe]:SEMask:AVERage:COUNT <integer> [:SENSe]:SEMask:AVERage:COUNT? [:SENSe]:SEMask:AVERage[:STATe] ON OFF 1 0 [:SENSe]:SEMask:AVERage[:STATe]?
Example	SEM:AVER:COUN 100 SEM:AVER:COUN? SEM:AVER ON SEM:AVER?
Notes	You must be in the Spectrum Analysis mode, W-CDMA mode, cdma2000 mode, TD-SCDMA mode, DTMB (CTTB) mode, DVB-T/H mode, ISDB-T mode, CMMB mode, LTE mode, LTE TDD mode, 1xEVDO mode or WIMAX OFDMA mode to use this command. Use :INSTRument:SElect to set the mode.
Preset	10 OFF
State Saved	Saved in instrument state.
Min	1
Max	10000
Initial S/W Revision	Prior to A.02.00
Modified at S/W Revision	A.02.00, A.03.00

Meas Type

Accesses a menu that enables you to select one of the following measurement reference types:

Total Pwr Ref – Sets the reference to the total carrier power and the measured data is shown in dBc and dBm.

PSD Ref – Sets the reference to the mean power spectral density of the carrier and the measured data is shown in dB and dBm/Hz.

Spectrum Peak Ref – Sets the reference to the spectrum peak power of the carrier and the measured data is shown in dB and dBm.

Key Path	Meas Setup
Mode	SA, WCDMA, C2K, WIMAX OFDMA, TD-SCDMA, 1xEVDO, DTMB (CTTB), DVB-T/H, ISDB-T, CMMB, LTE, LTETDD
Remote Command	[:SENSE] :SEMAsk:TYPE PSDRef TPreF SPRef [:SENSE] :SEMAsk:TYPE ?
Example	SEM:TYPE PSDR SEM:TYPE?
Notes	You must be in the Spectrum Analysis mode, W-CDMA mode, cdma2000 mode, TD-SCDMA mode, DTMB (CTTB) mode, DVB-T/H mode, ISDB-T mode, CMMB mode, LTE mode, LTE TDD mode, 1xEVDO mode or WIMAX OFDMA mode to use this command. Use :INSTrument:SELEct to set the mode.
Preset	SA, WCDMA, C2K, TD-SCDMA, 1xEVDO, DTMB (CTTB), DVB-T/H, ISDB-T, CMMB, LTE, LTETDD: TPreF WIMAX OFDMA: SPRef
State Saved	Saved in instrument state.
Range	Total Pwr Ref PSD Ref Spectrum Peak Ref
Initial S/W Revision	Prior to A.02.00
Modified at S/W Revision	A.02.00, A.03.00

Ref Channel

Accesses a menu that enables you to set up the measurement parameters used to calculate the power in the reference channel.

Key Path	Meas Setup
Initial S/W Revision	Prior to A.02.00

Integ BW

Specifies the integration bandwidth used to calculate the power in the reference channel.

Key Path	Meas Setup, Ref Channel
Mode	SA, WCDMA, C2K, WIMAX OFDMA, TD-SCDMA, 1xEVDO, DTMB (CTTB), DVB-T/H, ISDB-T, CMMB, LTE, LTETDD
Remote Command	[:SENSe] :SEMAsk:BAWdwidth[1] 2:INTEgration <bandwidth> [:SENSe] :SEMAsk:BAWdwidth[1] 2:INTEgration?
Example	SEM:BAND:INT 10 MHz SEM:BAND:INT?
Notes	10% . 100% of Channel Span Parameter Value Bandwidth sub op code, 1 is for BTS, 2 for MS. Default is BTS. You must be in the Spectrum Analysis mode, W-CDMA mode or cdma2000 mode, TD-SCDMA mode, DTMB (CTTB) mode, DVB-T/H mode, ISDB-T mode, CMMB mode, LTE mode, LTE TDD mode, 1xEVDO mode or WIMAX OFDMA mode to use this command. Use :INSTrument:SELEct to set the mode.
Couplings	Cannot be higher than the channel Span. If lower than 1/10 of channel Span, then the channel Span is reduced to be 10 times the Integ BW.
Preset	SA: 3.84 MHz WCDMA: 3.84 MHz 3.84 MHz C2K: 1.23 MHz 1.23 MHz WIMAX OFDMA: 10 MHz 10 MHz TD-SCDMA: 1.28 MHz 1.28 MHz 1xEVDO: 1.23MHz DTMB (CTTB): 7.56MHz DVB-T/H: 7.61MHz ISDB-T: 5.6MHz CMMB: 7.512MHz LTE: 4.515MHz 4.5MHz LTETDD: 4.515MHz 4.5MHz
State Saved	Saved in instrument state.
Min	1 kHz
Max	50 MHz
Initial S/W Revision	Prior to A.02.00
Modified at S/W Revision	A.02.00, A.03.00

Spectrum Emission Mask Measurement
Meas Setup

Span

Specifies the span used to calculate the power in the reference channel.

Key Path	Meas Setup, Ref Channel
Mode	SA, WCDMA, C2K, WIMAX OFDMA, TD-SCDMA, 1xEVDO, DTMB (CTTB), DVB-T/H, ISDB-T, LTE, LTETDD, CMMB
Remote Command	[:SENSe] :SEMAsk:FREQuency [1] 2:SPAN <freq> [:SENSe] :SEMAsk:FREQuency [1] 2:SPAN?
Example	SEM:FREQ:SPAN 3MHz SEM:FREQ:SPAN?
Notes	Frequency sub op code, 1 is for BTS, 2 for MS. Default is BTS. You must be in the Spectrum Analysis mode, W-CDMA mode, cdma2000 mode, TD-SCDMA mode, DTMB (CTTB) mode, DVB-T/H mode, ISDB-T mode, CMMB mode, LTE mode, LTE TDD mode, 1xEVDO mode or WIMAX OFDMA mode to use this command. Use :INSTrument:SELEct to set the mode.
Couplings	Range 1 kHz to 50 MHz (although restricted by Integ BW). If you set the channel Span lower than channel Integ BW, they will both track each other. As you increase the channel Span, the Integ BW will also increase if it is less than 1/10 of the channel Span.
Preset	SA: 5.0 MHz WCDMA: 5.0 MHz 5.0 MHz C2K: 1.25 MHz 1.25 MHz WIMAX OFDMA: 10 MHz 10 MHz TD-SCDMA: 1.6 MHz 1.6 MHz 1xEVDO: 1.25MHz DTMB (CTTB): 10MHz DVB-T/H: 10MHz ISDB-T: 8MHz CMMB: 10MHz LTE: 5 MHz LTETDD: 5 MHz
State Saved	Saved in instrument state.
Min	1 kHz
Max	50 MHz
Initial S/W Revision	Prior to A.02.00
Modified at S/W Revision	A.02.00, A.03.00

Sweep Time

Sets the sweep time used to calculate the power in the reference channel. Sweep Time can be set manually or put in auto mode.

Key Path	Meas Setup, Ref Channel
Mode	SA, WCDMA, C2K, WIMAX OFDMA, TD-SCDMA, 1xEVDO, DTMB (CTTB), DVB-T/H, ISDB-T, CMMB, LTE, LTETDD
Remote Command	[:SENSE] :SEMask:SWEep [1] 2:TIME <time> [:SENSE] :SEMask:SWEep [1] 2:TIME? [:SENSE] :SEMask:SWEep [1] 2:TIME:AUTO OFF 0 ON 1 [:SENSE] :SEMask:SWEep [1] 2:TIME:AUTO?
Example	SEM:SWE:TIME 9ms SEM:SWE:TIME? SEM:SWE:TIME:AUTO OFF SEM:SWE:TIME:AUTO?
Notes	Sweep Time sub op code, 1 is for BTS, 2 for MS. Default is BTS. You must be in the Spectrum Analysis mode, W-CDMA mode, cdma2000 mode, TD-SCDMA mode, DTMB (CTTB) mode, DVB-T/H mode, ISDB-T mode, CMMB mode, LTE mode, LTE TDD mode, 1xEVDO mode or WIMAX OFDMA mode to use this command. Use :INSTrument:SElect to set the mode.
Couplings	When the Sweep Time is set manually, Auto is set to OFF. Value is coupled with Channel Detector selection, Channel Resolution BW, Channel Video BW if the state is Auto. When set to Auto, the Sweep Time is automatically calculated
Preset	Automatically calculated ON
State Saved	Saved in instrument state.
Min	1 ms
Max	4000 s
Initial S/W Revision	Prior to A.02.00
Modified at S/W Revision	A.02.00, A.03.00

Res BW

Sets the resolution bandwidth used to calculate the power in the reference channel. The Channel Resolution BW can be set manually or put in to auto mode.

Key Path	Meas Setup, Ref Channel
----------	-------------------------

Spectrum Emission Mask Measurement
Meas Setup

Mode	SA, WCDMA, C2K, WIMAX OFDMA, TD-SCDMA, 1xEVDO, DTMB (CTTB), DVB-T/H, ISDB-T, CMMB, LTE, LTETDD
Remote Command	[:SENSe]:SEMAsk:BAWdwidth[1] 2[:RESolution] <bandwidth> [:SENSe]:SEMAsk:BAWdwidth[1] 2[:RESolution]? [:SENSe]:SEMAsk:BAWdwidth[1] 2[:RESolution]:AUTO OFF ON 1 0 [:SENSe]:SEMAsk:BAWdwidth[1] 2[:RESolution]:AUTO?
Example	SEM:BAWd 100 kHz SEM:BAWd? SEM:BAWd:AUTO ON SEM:BAWd:AUTO?
Notes	Bandwidth sub op code, 1 is for BTS, 2 for MS. Default is BTS. You must be in the Spectrum Analysis mode, W-CDMA mode, cdma2000 mode, TD-SCDMA mode, DTMB (CTTB) mode, DVB-T/H mode, ISDB-T mode, CMMB mode, LTE mode, LTE TDD mode, 1xEVDO mode or WIMAX OFDMA mode to use this command. Use :INSTRument:SELEct to set the mode.
Couplings	When Res BW is set manually, Channel Resolution BW Mode is set to MANual. Value is coupled with Channel Detector selection, Channel Sweep Time, Channel Video BW. When set to Auto, the resolution bandwidth is automatically calculated.
Preset	SA: 100 kHz WCDMA: 75 kHz C2K: 24 kHz WIMAX OFDMA: 100 kHz TD-SCDMA: 30 kHz 1xEVDO: 30.0kHz DTMB (CTTB): 3.9kHz DVB-T/H: 3.9kHz ISDB-T: 10kHz CMMB: 3.9kHz LTE, LTETDD:Auto (47 kHz) ON
State Saved	Saved in instrument state.
Min	1 Hz
Max	8 MHz

Backwards Compatibility SCPI	[[:SENSE]:SEMAsk:BWIDth[1]]2[:RESolution]
Initial S/W Revision	Prior to A.02.00
Modified at S/W Revision	A.02.00, A.03.00

Video BW

Sets the video bandwidth used to calculate the power in the reference channel. The Channel Video BW can be set manually or put in to auto mode.

Key Path	Meas Setup, Ref Channel
Mode	SA, WCDMA, C2K, WIMAX OFDMA, TD-SCDMA, 1xEVDO, DTMB (CTTB), DVB-T/H, ISDB-T, CMMB, LTE, LTETDD
Remote Command	[:SENSE]:SEMAsk:BANdwidth[1] 2:VIDeo <bandwidth> [:SENSE]:SEMAsk:BANdwidth[1] 2:VIDeo? [:SENSE]:SEMAsk:BANdwidth[1] 2:VIDeo:AUTO OFF ON 1 0 [:SENSE]:SEMAsk:BANdwidth[1] 2:VIDeo:AUTO?
Example	SEM:BANd:VID 100 kHz SEM:BANd:VID? SEM:BANd:VID:AUTO ON SEM:BANd:VID:AUTO?
Notes	Bandwidth sub op code, 1 is for BTS, 2 for MS. Default is BTS. You must be in the Spectrum Analysis mode, W-CDMA mode, cdma2000 mode, TD-SCDMA mode, DTMB (CTTB) mode, DVB-T/H mode, ISDB-T mode, CMMB mode, LTE mode, LTE TDD mode, 1xEVDO mode or WIMAX OFDMA mode to use this command. Use :INSTRument:SElect to set the mode.
Couplings	When Video BW is set manually, Channel Video BW Mode is set to MANual Value is coupled with Channel Detector selection, Channel Sweep Time, Channel Resolution BW. When set to Auto, the video bandwidth is automatically calculated.

Spectrum Emission Mask Measurement
Meas Setup

Preset	SA: 100 kHz WCDMA: 75 kHz C2K: 24 kHz WIMAX OFDMA: 30 kHz TD-SCDMA: 300 kHz 1xEVDO: 300.0kHz DTMB (CTTB): 39kHz DVB-T/H: 39kHz ISDB-T: 1kHz CMMB: 39kHz LTE: Auto LTETDD: Auto ON
State Saved	Saved in instrument state.
Min	1 Hz
Max	50 MHz
Backwards Compatibility SCPI	[:SENSe]:SEMAsk:BWIDth[1] 2:VIDeo
Initial S/W Revision	Prior to A.02.00
Modified at S/W Revision	A.02.00, A.03.00

VBW/RBW

Sets the Video BW/Resolution BW Ratio to calculate the Channel Resolution BW and Channel Video BW. The VBW/RBW Ratio can be set manually or put in to auto mode.

Key Path	Meas Setup, Ref Channel
Mode	SA, WCDMA, C2K, WIMAX OFDMA, TD-SCDMA mode, 1xEVDO, DTMB (CTTB), DVB-T/H, ISDB-T, CMMB, LTE, LTETDD
Remote Command	[:SENSe]:SEMAsk:BA ^N Dwidth[1] 2:VIDeo:RA ^T io <real> [:SENSe]:SEMAsk:BA ^N Dwidth[1] 2:VIDeo:RA ^T io [:SENSe]:SEMAsk:BA ^N Dwidth[1] 2:VIDeo:RA ^T io:AUTO OFF ON 1 0 [:SENSe]:SEMAsk:BA ^N Dwidth[1] 2:VIDeo:RA ^T io:AUTO?
Example	SEM:BA ^N D:VID:RA ^T 0.1 SEM:BA ^N D:VID:RA ^T ? SEM:BA ^N D:VID:RA ^T :AUTO ON SEM:BA ^N D:VID:RA ^T IO:AUTO?

Notes	Bandwidth sub op code, 1 is for BTS, 2 for MS. Default is BTS. You must be in the Spectrum Analysis mode, W-CDMA mode, cdma2000 mode, TD-SCDMA mode, DTMB (CTTB) mode, DVB-T/H mode, ISDB-T mode, CMMB mode, LTE mode, LTE TDD mode 1xEVDO mode or WIMAX OFDMA mode to use this command. Use :INSTrument:SELEct to set the mode.
Couplings	When Res BW is set manually, Mode coupling is set to MANual When set to Auto, the VBW/RBW Ratio is automatically calculated.
Preset	SA, WCDMA, C2K: 1.0 WIMAX OFDMA: 0.3 TD-SCDMA: 10 1xEVDO: 10.0 DTMB (CTTB): 10 DVB-T/H: 10 ISDB-T: 0.1 CMMB: 10 LTE: Auto LTETDD: Auto ON
State Saved	Saved in instrument state.
Min	0.00001
Max	3000000
Backwards Compatibility SCPI	[:SENSe]:SEMAsk:BWIDth[1] 2:VIDeo:RATio
Initial S/W Revision	Prior to A.02.00
Modified at S/W Revision	A.02.00, A.03.00

Power Ref

Sets the power reference in the carrier that will be used to compute the relative values for the offsets.

Key Path	Meas Setup, Ref Channel
Initial S/W Revision	Prior to A.02.00

Total Power

Sets the power in the carrier (ref channel) that will be used to compute the relative power values for the offsets. When the state is set to auto, this value is set to the measured carrier reference power. When set

Spectrum Emission Mask Measurement
Meas Setup

to manual, the result takes on the last measured value, or can be manually entered.

Key Path	Meas Setup, Ref Channel, Power Ref
Mode	SA, WCDMA, C2K, WIMAX OFDMA, TD-SCDMA, 1xEVDO, DTMB (CTTB), DVB-T/H, ISDB-T, CMMB, LTE, LTETDD
Remote Command	[:SENSE] :SEMAsk :CARRier [:POWer] <real> [:SENSE] :SEMAsk :CARRier [:POWer] ? [:SENSE] :SEMAsk :CARRier :AUTO [:STATE] OFF ON 1 0 [:SENSE] :SEMAsk :CARRier :AUTO [:STATE] ?
Example	SEM:CARR 100dBm SEM:CARR? SEM:CARR:AUTO OFF SEM:CARR:AUTO?
Notes	The min and max values given are for Meas Type = Total Pwr Ref. You must be in the Spectrum Analysis mode, W-CDMA mode, cdma2000 mode, TD-SCDMA mode, DTMB (CTTB) mode, DVB-T/H mode, ISDB-T mode, CMMB mode, LTE mode, LTE TDD mode, 1xEVDO mode or WIMAX OFDMA mode to use this command. Use :INSTRument:SELEct to set the mode. This BAF SCPI command is available in all the Meas Type case.
Dependencies	This "Total Power Ref" parameter is coupled with the "Meas Type" parameter. The softkey would be active if the Meas Type is set to Total Power Ref. Otherwise, it is grayed out.
Preset	Measured carrier reference power
State Saved	Saved in instrument state.
Min	-200 dBm
Max	200 dBm
Initial S/W Revision	Prior to A.02.00
Modified at S/W Revision	A.02.00, A.03.00

PSD

Sets the power spectral density in the carrier that is used to compute the relative power spectral density values for the offsets when Meas Type is set to PSD Ref. When the state is set to auto, this will be set to the measured carrier power spectral density.

Key Path	Meas Setup, Ref Chan, Power Ref
Mode	SA, WCDMA, C2K , WIMAX OFDMA, TD-SCDMA, 1xEVDO, DTMB (CTTB), DVB-T/H, ISDB-T, CMMB, LTE, LTETDD

Remote Command	[:SENSE] :SEMAsk:CARRier:CPSD <real> [:SENSE] :SEMAsk:CARRier:CPSD?
Example	SEM:CARR:CPSD -80 SEM:CARR:CPSD?
Notes	Although the default value is defined, the value is recalculated by the measurement result just after completing the measurement. Carrier sub op code. 1 for BTS, 2 for MS. Default is BTS. You must be in the Spectrum Analysis mode, W-CDMA mode, cdma2000 mode, TD-SCDMA mode, DTMB (CTTB) mode, DVB-T/H mode, ISDB-T mode, CMMB mode, LTE mode, LTE TDD mode 1xEVDO mode or WIMAX OFDMA mode to use this command. Use :INSTrument:SElect to set the mode.
Dependencies	See Couplings
Couplings	This "PSD" parameter is coupled with the "Meas Type" parameter. The key will be active if the Meas Type is set to PSD. Otherwise, it is grayed out.
Preset	Measured carrier PSD reference power
State Saved	Saved in instrument state.
Min	-200
Max	200
Initial S/W Revision	Prior to A.02.00
Modified at S/W Revision	A.02.00, A.03.00

Spectrum Peak

Sets the spectrum peak power in the carrier that is used to compute the relative power spectral density values for the offsets when Meas Type is set to Spectrum Peak. When the state is set to auto, this will be set to the measured carrier spectrum peak power. When set to manual, the result takes on the last measured value, or can be manually entered

Key Path	Meas Setup, Ref Channel, Power Ref
Mode	SA, WCDMA, C2K , WIMAX OFDMA, TD-SCDMA, 1xEVDO, DTMB (CTTB), DVB-T/H, ISDB-T, CMMB, LTE, LTETDD
Remote Command	[:SENSE] :SEMAsk:CARRier:PEAK[:POWer] <real> [:SENSE] :SEMAsk:CARRier:PEAK[:POWer] ?
Example	SEM:CARR:PEAK -80 SEM:CARR:PEAK:POWER?

Spectrum Emission Mask Measurement

Meas Setup

Notes	Although the default value is defined, the value is recalculated by the measurement result just after completing the measurement. Carrier sub op code. 1 for BTS, 2 for MS. Default is BTS. You must be in the Spectrum Analysis mode, W-CDMA mode, cdma2000 mode, TD-SCDMA mode, DTMB (CTTB) mode, DVB-T/H mode, ISDB-T mode, CMMB mode, LTE mode, LTE TDD mode, 1xEVDO mode or WIMAX OFDMA mode to use this command. Use :INSTRUMENT:SElect to set the mode.
Dependencies	See Couplings
Couplings	This "Spectrum Peak Ref" parameter is coupled with the "Meas Type" parameter. This softkey would be active if the "Meas Type" is set to "Spectrum Peak Ref". Otherwise, grayout.
Preset	Measured carrier Spectrum Peak reference power
State Saved	Saved in instrument state.
Min	-200
Max	200
Initial S/W Revision	Prior to A.02.00
Modified at S/W Revision	A.02.00, A.03.00

Offsets/Limit

Accesses a menu that enables you to set up the measurement parameters for the offset pairs. For example, you can assign the start and stop frequencies, select the resolution bandwidth, and set the sweep time.

Key Path	Meas Setup
Initial S/W Revision	Prior to A.02.00

Select Offset

Selects the offset pairs (upper and lower) that affect the menu keys, and displays the memory selection menu from A to F. The memory selection menu allows you to store up to 5 sets of parameter values for the offset pairs, such as Start Freq, Stop Freq, Sweep Time, Res BW, Meas BW, Abs Start, and Abs Stop. Press Offset until the letter of the desired offset (A, B, C, D, E, or F) is underlined. Only one selection at a time is shown on this menu key label.

Key Path	Meas Setup, Offsets/Limit
Mode	SA, WCDMA, C2K, WIMAX OFDMA, TD-SCDMA, 1xEVDO, DTMB (CTTB), DVB-T/H, ISDB-T, CMMB, LTE, LTETDD
Preset	A
Range	A B C D E F

Initial S/W Revision	Prior to A.02.00
Modified at S/W Revision	A.02.00, A.03.00

Start Freq

Specifies the start frequency for the currently selected offset and enables you to toggle this function On or Off for each offset.

Key Path	Meas Setup, Offset/Limit
Mode	SA, WCDMA, C2K, WIMAX OFDMA, TD-SCDMA, 1xEVDO, DTMB (CTTB), DVB-T/H, ISDB-T, CMMB, LTE, LTETDD
Remote Command	<pre>[:SENSE] :SEMAsk:OFFSet [1] 2 :LIST:FREQuency:STARt <freq>, <freq>, <freq>, <freq>, <freq>, <freq> [:SENSE] :SEMAsk:OFFSet [1] 2 :LIST:FREQuency:STARt? [:SENSE] :SEMAsk:OFFSet [1] 2 :LIST:STATe ON OFF 1 0, ON OFF 1 0, ON OFF 1 0, ON OFF 1 0, ON OFF 1 0, ON OFF 1 0 [:SENSE] :SEMAsk:OFFSet [1] 2 :LIST:STATe?</pre>
Example	<pre>SEM:OFFS2:LIST:FREQ:STAR 100 kHz SEM:OFFS2:LIST:FREQ:STAR? SEM:OFFS:LIST:STAT ON SEM:OFFS:LIST:STAT?</pre>
Notes	<p>Comma separated list of 6 values. OFFSet1 is for BTS, 2 for MS. Default is BTS.</p> <p>You must be in the Spectrum Analysis mode, W-CDMA mode, cdma2000 mode, TD-SCDMA mode, DTMB (CTTB) mode, DVB-T/H mode, ISDB-T mode, CMMB mode, LTE mode, LTE TDD mode 1xEVDO mode or WIMAX OFDMA mode to use this command. Use :INSTrument:SElect to set the mode.</p>
Couplings	<p>Coupled to Stop Freq. Start cannot go above the stop freq less 100Hz. Similarly Stop freq cannot go below Start Freq plus 100Hz.</p> <p>If the current mode is DVB-T/H, this value will be modified automatically according to the limit type and the output power of the transmitter which is less or more than 25W.</p> <p>If the current mode is ISDB-T, this value will be modified automatically according to the limit type.</p>

Spectrum Emission Mask Measurement
Meas Setup

Preset	<p>SA: 2.515 MHz, 2.715 MHz, 3.515 MHz, 4.00 MHz, 8.00 MHz, 12.50 MHz</p> <p>WCDMA: 2.515 MHz, 2.715 MHz, 3.515 MHz, 4.000 MHz, 8.000 MHz, 12.50 MHz 2.515MHz, 4.000 MHz, 7.500 MHz, 8.500 MHz, 12.5 MHz, 15 MHz</p> <p>C2K: 750.0 kHz, 780.0 kHz, 1.980 MHz, 3.25 MHz, 7.0 MHz, 7.0 MHz 885 kHz, 1.980 MHz, 2.250 MHz, 8.0 MHz, 12.0 MHz, 12.0 MHz</p> <p>WIMAX OFDMA: 4.75MHz,5.45MHz,9.75MHz,14.75MHz,19.75MHz,24.75MHz 4.75MHz,5.45MHz,9.75MHz,14.75MHz,19.75MHz,24.75MHz</p> <p>TD-SCDMA: 815kHz,1015kHz,1815kHz,2.3MHz, ,2.3MHz,,2.3MHz 815kHz,1815kHz,2.9MHz, 2.9MHz,2.9MHz,2.9MHz</p> <p>1xEVDO: 765.0kHz, 795.0kHz, 1.995MHz, 3.253125MHz, 7.5MHz, 7.5MHz 900.0kHz, 1.995MHz, 1.995MHz, 1.995MHz, 1.995MHz, 1.995MHz, 1.995MHz</p> <p>DTMB (CTTB): 3.8MHz, 4.2MHz, 6MHz, 12MHz, 12MHz, 12MHz</p> <p>DVB-T/H: 3.81MHz, 4.2MHz, 6MHz, 12MHz, 12MHz, 12MHz</p> <p>ISDB-T: 2.79MHz, 2.86MHz, 3.0MHz, 4.36MHz, 15.0MHz, 15.0MHz</p> <p>CMMB: 3.8MHz, 4.2MHz, 8.0MHz, 12.0MHz,12.0MHz, 12.0MHz</p> <p>LTE, LTETDD: 50kHz, 5.05 MHz, 10.5 MHz, 15.00 MHz, 30 MHz, 40 MHz 15.00 kHz,1.5 MHz,5.5 MHz,6.5 MHz,10 MHz,20MHz</p> <p>SA: ON, ON, ON, ON, ON, OFF</p> <p>WCDMA: ON, ON, ON, ON, ON, OFF ON, ON, ON, ON, OFF, OFF</p> <p>C2K: ON, ON, ON, OFF, OFF, OFF ON, ON, OFF, OFF, OFF, OFF</p> <p>WIMAX OFDMA: ON, ON, ON, OFF, OFF, OFF ON, ON, ON, OFF, OFF, OFF</p> <p>TD-SCDMA: ON, ON, ON, ON, OFF, OFF ON, ON, ON, OFF, OFF, OFF</p> <p>1xEVDO: ON, ON, ON, OFF, OFF, OFF ON, ON, OFF, OFF, OFF, OFF</p> <p>DTMB (CTTB): ON, ON, ON, OFF, OFF, OFF</p> <p>DVB-T/H: ON, ON, ON, OFF, OFF, OFF</p> <p>ISDB-T: ON, ON, ON, ON, OFF, OFF</p> <p>CMMB: ON, ON, ON, OFF, OFF, OFF</p> <p>LTE, LTETDD: ON, ON, ON, OFF, OFF, OFF ON,ON,ON,ON,OFF,OFF</p>
State Saved	Saved in instrument state.
Min	0 Hz
Max	Stop Freq minus (-) 100 Hz (for that offset)
Initial S/W Revision	Prior to A.02.00
Modified at S/W Revision	A.02.00, A.03.00

Stop Freq

Specifies the stop frequency for the currently selected offset.

Key Path	Meas Setup, Offset/Limit
Mode	SA, WCDMA, C2K, WIMAX OFDMA, TD-SCDMA, 1xEVDO, DTMB (CTTB), DVB-T/H, ISDB-T, CMMB, LTE, LTETDD
Remote Command	[:SENSE] :SEMAsk:OFFSet [1] 2 :LIST:FREQuency:STOP <freq>, <freq>, <freq>, <freq>, <freq>, <freq> [:SENSE] :SEMAsk:OFFSet [1] 2 :LIST:FREQuency:STOP?
Example	SEM:OFFS:LIST:FREQ:STOP 100 kHz SEM:OFFS:LIST:FREQ:STOP?
Notes	Comma separated list of 6 values. OFFSet1 is for BTS, 2 for MS. Default is BTS. You must be in the Spectrum Analysis mode, W-CDMA mode, cdma2000 mode, TD-SCDMA mode, DTMB (CTTB) mode, DVB-T/H mode, ISDB-T mode, CMMB mode, LTE mode, LTE TDD mode 1xEVDO mode or WIMAX OFDMA mode to use this command. Use :INSTrument:SElect to set the mode.
Couplings	Coupled to Start Freq. Start cannot go above the stop freq less 100Hz. Similarly Stop freq cannot go below Start Freq plus 100Hz. If the current mode is DVB-T/H, this value will be modified automatically according to the limit type and the output power of the transmitter which is less or more than 25W. If the current mode is ISDB-T, this value will be modified automatically according to the limit type.

Spectrum Emission Mask Measurement
Meas Setup

Preset	SA: 2.715 MHz, 3.515 MHz, 4.00 MHz, 8.00 MHz, 12.50 MHz, 15.0 MHz WCDMA:2.715 MHz, 3.515 MHz, 4.000 MHz, 8.000 MHz, 12.50 MHz, 15.0 MHz 3.485 MHz, 7.500 MHz, 8.500 MHz, 12.00 MHz, 15.00 MHz, 18.0 MHz C2K: 780.0kHz, 1.980 MHz, 4.0 MHz, 4.0 MHz, 12.0 MHz, 12.0 MHz 1.980 MHz 4.0MHz, 4.0 MHz, 11.5 MHz, 14.5 MHz, 14.5 MHz WIMAX OFDMA: 5.45MHz,9.75MHz,14.75MHz,19.75MHz,24.75MHz,29.75MHz 5.45MHz,9.75MHz,14.75MHz,19.75MHz,24.75MHz,29.75MHz TD-SCDMA: 1015kHz,1815kHz,2.3MHz,4MHz, 4MHz,4MHz 1785kHz,2385kHz,3.5MHz, 3.5MHz ,3.5MHz ,3.5MHz 1xEVDO: 795.0kHz, 1.995MHz, 4.015MHz, 4.003125MHz, 12.5MHz, 12.5MHz 1.995MHz, 4.015MHz, 4.015MHz, 4.015MHz, 4.015MHz, 4.015MHz DTMB (CTTB): 4.2MHz, 6MHz, 12MHz, 12MHz, 12MHz, 12MHz DVB-T/H: 4.2MHz, 6MHz, 12MHz, 12MHz, 12MHz, 12MHz ISDB-T: 2.86MHz, 3.0MHz, 4.36MHz, 15.0MHz, 15.0MHz, 15.0MHz CMMB: 4.2MHz, 8.0MHz, 12.0MHz,12.0MHz, 12.0MHz, 12.0MHz LTE, LTETDD: 5.05 MHz, 10.05 MHz, 15 MHz, 30 MHz, 40 MHz, 50 MHz 985.0 kHz, 4.50 MHz,5.5001 MHz,9.50 MHz,20 MHz,40MHz
State Saved	Saved in instrument state.
Min	Start Freq plus (+) 100 Hz (for that offset)
Max	500 MHz
Initial S/W Revision	Prior to A.02.00
Modified at S/W Revision	A.02.00, A.03.00

Sweep Time

Specifies the sweep time for the currently selected offset and enables you to toggle this function On or Off for each offset.

Key Path	Meas Setup, Offset/Limit
Mode	SA, WCDMA, C2K, WIMAX OFDMA, TD-SCDMA, 1xEVDO, DTMB (CTTB), DVB-T/H, ISDB-T, CMMB, LTE, LTETDD

Remote Command	<pre>[:SENSE] :SEMAsk:OFFSet [1] 2:LIST:SWEep:TIME <time>, <time>, <time>, <time>, <time>, <time> [:SENSE] :SEMAsk:OFFSet [1] 2:LIST:SWEep:TIME? [:SENSE] :SEMAsk:OFFSet [1] 2:LIST:SWEep:TIME:AUTO ON OFF 1 0, ON OFF 1 0, ON OFF 1 0, ON OFF 1 0, ON OFF 1 0, ON OFF 1 0 [:SENSE] :SEMAsk:OFFSet [1] 2:LIST:SWEep:TIME:AUTO?</pre>
Example	<pre>SEM:OFFS2:LIST:SWE:TIME 1.0 ms, 3.4 ms, 2.08 ms, 1.0 ms, 1.0 ms, 1.0 ms SEM:OFFS2:LIST:SWE:TIME? SEM:OFFS2:LIST:SWE:TIME:AUTO ON, ON, ON, ON, OFF, OFF SEM:OFFS2:LIST:SWE:TIME:AUTO?</pre>
Notes	<p>Comma separated list of 6 values. OFFSet1 is for BTS, 2 for MS. Default is BTS.</p> <p>You must be in the Spectrum Analysis mode, W-CDMA mode, cdma2000 mode, TD-SCDMA mode, DTMB (CTTB) mode, DVB-T/H mode, ISDB-T mode, CMMB mode, LTE mode, LTE TDD mode 1xEVDO mode or WIMAX OFDMA mode to use this command. Use :INSTrument:SElect to set the mode.</p>
Couplings	<p>When the sweep time is set manually, Mode coupling is set to MANUAL</p> <p>If the current mode is DVB-T/H, this value will be modified automatically according to the output power of the transmitter which is less or more than 25W.</p> <p>If the current mode is ISDB-T, this value will be modified automatically according to the limit type.</p>
Preset	<p>Automatically calculated</p> <p>ON,ON,ON,ON,ON,ON</p>
State Saved	Saved in instrument state.
Min	1 ms
Max	10 s
Backwards Compatibility SCPI	[:SENSe]:SEMAsk:OFFSet[1] 2:LIST:SWEep[:TIME]
Initial S/W Revision	Prior to A.02.00
Modified at S/W Revision	A.02.00, A.03.00

Offset Side

Specifies which offset side to measure.

You can turn off (not use) specific offsets with [:SENSe]:SEMAsk:OFFSet[n]:LIST:STATe.

BOTH - both of the negative (lower) and positive (upper) sidebands

Spectrum Emission Mask Measurement
Meas Setup

NEGative - negative (lower) sideband only

POSitive - positive (upper) sideband only

Key Path	Meas Setup, Offset/Limit
Mode	SA, WCDMA, C2K, WIMAX OFDMA, TD-SCDMA, 1xEVDO, DTMB (CTTB), DVB-T/H, ISDB-T, CMMB, LTE, LTETDD
Remote Command	[:SENSe] :SEMAsk:OFFSet [1] 2 :LIST:SIDE BOTH NEGAtive POSitive, BOTH NEGAtive POSitive, BOTH NEGAtive POSitive, BOTH NEGAtive POSitive, BOTH NEGAtive POSitive, BOTH NEGAtive POSitive, BOTH NEGAtive POSitive [:SENSe] :SEMAsk:OFFSet [1] 2 :LIST:SIDE?
Example	SEM:OFFS:LIST:SIDE BOTH SEM:OFFS:LIST:SIDE?
Notes	OFFSet1 is for BTS, 2 for MS. Default is BTS. You must be in the Spectrum Analysis mode, W-CDMA mode, cdma2000 mode, TD-SCDMA mode, DTMB (CTTB) mode, DVB-T/H mode, ISDB-T mode, CMMB mode, LTE mode, LTE TDD mode, 1xEVDO mode or WIMAX OFDMA mode to use this command. Use :INSTrument:SElect to set the mode.
Preset	BOTH, BOTH, BOTH, BOTH, BOTH, BOTH
State Saved	Saved in instrument state.
Range	Neg Both Pos
Initial S/W Revision	Prior to A.02.00
Modified at S/W Revision	A.02.00, A.03.00

Res BW

Specifies which Resolution BW filter to use when measuring the currently selected offset.

Offset Res BW Mode allows the instrument to determine the optimum Resolution BW filter to use when measuring the currently selected offset.. When changing the Meas BW parameter, if the Res BW needs to be changed to adhere to the rule

$$(N \times \text{Res BW}) \leq (\text{Stop freq of the offset} - \text{Start freq of the offset}),$$

where N is the multiplier, this setting will automatically be changed to manual.

Key Path	Meas Setup, Offset/Limit
Mode	SA, WCDMA, C2K, WIMAX OFDMA, TD-SCDMA, 1xEVDO mode, DTMB (CTTB), DVB-T/H, ISDB-T, CMMB, LTE, LTETDD

<p>Remote Command</p>	<pre>[:SENSe] :SEMAsk:OFFSet [1] 2:LIST:BANDwidth[:RESolution] <bandwidth>, <bandwidth>, <bandwidth>, <bandwidth>, <bandwidth>, <bandwidth> [:SENSe] :SEMAsk:OFFSet [1] 2:LIST:BANDwidth[:RESolution] ? [:SENSe] :SEMAsk:OFFSet [1] 2:LIST:BANDwidth[:RESolution] :AUTO OFF ON 1 0, OFF ON 1 0, OFF ON 1 0, OFF ON 1 0, OFF ON 1 0, OFF ON 1 0 [:SENSe] :SEMAsk:OFFSet [1] 2:LIST:BANDwidth[:RESolution] :AUTO?</pre>
<p>Example</p>	<pre>SEM:OFFS2:LIST:BAND 30.0 kHz, 30.0 kHz, 30.0 kHz, 1.00 MHz,1.00 MHz, 1.00 MHz SEM:OFFS2:LIST:BAND? SEM:OFFS:LIST:BAND:AUTO 1,1,1,1,1,1 SEM:OFFS:LIST:BAND:AUTO?</pre>
<p>Notes</p>	<p>Comma separated list of 6 values. Sub op code OFFSet1 is for BTS, 2 for MS. Default is BTS.</p> <p>You must be in the Spectrum Analysis mode, W-CDMA mode, cdma2000 mode, TD-SCDMA mode, DTMB (CTTB) mode, DVB-T/H mode, ISDB-T mode, CMMB mode, LTE mode, LTE TDD mode 1xEVDO mode or WIMAX OFDMA mode to use this command. Use :INSTrument:SElect to set the mode.</p>
<p>Couplings</p>	<p>Coupled to Start and Stop offset and Meas BW multiplier. This parameter must adhere to the rule $(N \times \text{Res BW}) \leq (\text{Stop freq of the offset} - \text{Start freq of the offset})$, where N is the multiplier. If the multiplier is changed, the Res BW will be changed to ensure this. When set manually, Res BW Coupling is set to manual.</p>

Spectrum Emission Mask Measurement
Meas Setup

Preset	SA: 30.0 kHz, 30.0 kHz, 30.0 kHz, 1.00 MHz,1.00 MHz, 1.00 MHz WCDMA: 30.00 kHz, 30.00 kHz, 30.00 kHz, 100.00 kHz, 1.000 MHz, 1.00 MHz 30.00 kHz, 1.000 MHz, 1.000 MHz, 1.000 MHz, 1.000 MHz, 1.00 MHz C2K: 3.00 kHz, 30.00 kHz, 30.00 kHz, 6.2 kHz, 1.000 MHz, 1.00 MHz 30.00 kHz, 30.00 kHz, 6.2 kHz, 1.000 MHz, 1.000 MHz, 1.00 MHz WIMAX OFDMA: 100 KHz, 100 KHz, 100 KHz, 100 KHz, 100 KHz, 100 KHz 100 KHz, 100 KHz, 100 KHz, 100 KHz, 100 KHz, 100 KHz TD-SCDMA: 30 kHz, 30 kHz, 30 kHz, 50 kHz, 1 MHz, 1 MHz 30 kHz, 30 kHz, 50 kHz, 1 MHz, 1 MHz, 1 MHz 1xEVDO: 30.00 kHz, 30.00 kHz, 30.00 kHz, 6.2 kHz, 1.000 MHz, 1.000 MHz 30.00 kHz, 30.00 kHz, 30.00 kHz, 30.00 kHz, 30.00 MHz, 30.00 MHz DTMB (CTTB): 3.9kHz, 3.9kHz, 3.9kHz, 3.9kHz, 3.9kHz, 3.9kHz DVB-T/H: 3.9kHz, 3.9kHz, 3.9kHz, 3.9kHz, 3.9kHz, 3.9kHz ISDB-T: 10.0kHz, 10.0kHz, 10.0kHz, 10.0kHz, 10.0kHz, 10.0kHz CMMB: 3.9kHz, 3.9kHz, 3.9kHz, 3.9kHz, 3.9kHz, 3.9kHz LTE, LTETDD: 51 kHz, 100 kHz, 1.0 MHz, 1.0 MHz,1.0 MHz, 1.0 MHz 15.0kHz, 510kHz,1.0MHz,1.0MHz,1.0MHz,1.0MHz OFF, OFF, OFF, OFF, OFF, OFF OFF, OFF, OFF, OFF, OFF, OFF
State Saved	Saved in instrument state.
Min	1 Hz
Max	8 MHz
Backwards Compatibility SCPI	[:SENSE]:SEMask:OFFSet[1] 2:LIST:BWIDth[:RESolution]
Initial S/W Revision	Prior to A.02.00
Modified at S/W Revision	A.02.00, A.03.00

Meas BW

Allows you to specify a multiplier of Res BW for the measurement integration bandwidth.

Meas BW is multiplier integer number. It shows a ratio between Integration BW and Resolution BW of the measurement result.

$$\text{Integ BW} = \text{Meas BW} * \text{Resolution BW}$$

Integration BW is desired resolution bandwidth and Resolution BW is actual bandwidth for sweep. Measurement sweeps with Resolution BW and Meas BW compensates sweep resolution bandwidth to Integration BW.

If you set this parameter greater than 1, you can set Resolution BW narrower to avoid carrier power leakage effect to the offset power integration.

Key Path	Meas Setup, Offset/Limit
----------	---------------------------------

Mode	SA, WCDMA, C2K, WIMAX OFDMA, TD-SCDMA, 1xEVDO, DTMB (CTTB), DVB-T/HISDB-T, CMMB, LTE, LTETDD
Remote Command	[:SENSE] :SEMAsk:OFFSet [1] 2 :LIST:BA NDwidth:IMULti <integer>, <integer>, <integer>, <integer>, <integer>, <inte ger> [:SENSE] :SEMAsk:OFFSet [1] 2 :LIST:BA NDwidth:IMULti?
Example	SEM:OFFS2:LIST:BA ND:IMUL 1,1,1,1,1,1 SEM:OFFS2:LIST:BA ND:IMUL?
Notes	Comma separated list of 6 values. OFFSet1 is for BTS, 2 for MS. Default is BTS. You must be in the Spectrum Analysis mode, W-CDMA mode, cdma2000 mode, TD-SCDMA mode, DTMB (CTTB) mode, DVB-T/H mode, ISDB-T mode, CMMB mode, LTE mode, LTE TDD mode 1xEVDO mode or WIMAX OFDMA mode to use this command. Use :INST Rument:SElect to set the mode.
Couplings	This parameter must adhere to the rule (N x Res BW) <= (Stop freq of the offset - Start freq of the offset), where N is the multiplier. If the Res Bw is changed, the multiplier will be changed to ensure this.
Preset	SA: 1, 1, 1, 1, 1, 1 WCDMA: 1, 1, 1, 10, 1, 1 1, 1, 1, 1, 1, 1 C2K: 10, 1, 1, 1, 1, 1 1, 1, 1, 1, 1, 1 WIMAX OFDMA: 1, 1, 1, 1, 1, 1 1, 1, 1, 1, 1, 1 TD-SCDMA:1, 1, 1, 20, 1, 1 1, 1, 20, 1, 1, 1 1xEVDO: 1, 1, 1, 1, 1 1, 1, 1, 1, 1, 1 DTMB (CTTB): 1, 1, 1, 1, 1, 1 DVB-T/H: 1, 1, 1, 1, 1, 1 ISDB-T: 1, 1, 1, 1, 1, 1 CMMB: 1, 1, 1, 1, 1, 1 LTE: 2, 1, 1, 1, 1, 1 2, 2, 1, 1, 1, 1 LTETDD: 2, 1, 1, 1, 1, 1 2, 2, 1, 1, 1, 1
State Saved	Saved in instrument state.
Min	1
Max	1000
Backwards Compatibility SCPI	[:SENSe] :SEMAsk:OFFSet[1] 2:LIST:BWIDth:IMULti
Initial S/W Revision	Prior to A.02.00
Modified at S/W Revision	A.02.00, A.03.00

Spectrum Emission Mask Measurement
Meas Setup

Video BW

Changes the analyzer post-detection filter.

Key Path	Meas Setup, Offset/Limit
Mode	SA, WCDMA, C2K, WIMAXOFDMA, TD-SCDMA, 1xEVDO, DTMB (CTTB), DVB-T/HISDB-T, CMMB, LTE, LTETDD
Remote Command	<pre>[:SENSE] :SEMAsk:OFFSet [1] 2 :LIST:BAWdwidth:VIDeo <freq>, <freq>, <freq>, <freq>, <freq>, <freq> [:SENSE] :SEMAsk:OFFSet [1] 2 :LIST:BAWdwidth:VIDeo? [:SENSE] :SEMAsk:OFFSet [1] 2 :LIST:BAWdwidth:VIDeo:AUTO OFF ON 0 1, OFF ON 0 1, OFF ON 0 1, OFF ON 0 1, OFF ON 0 1, OFF ON 0 1 [:SENSE] :SEMAsk:OFFSet [1] 2 :LIST:BAWdwidth:VIDeo:AUTO?</pre>
Example	<pre>SEM:OFFS2:LIST:BAWd:VID 3.00 kHz, 3.00 kHz, 3.00 kHz, 100.0 kHz,100.0 kHz, 100.0 kHz SEM:OFFS2:LIST:BAWd:VID? SEM:OFFS2:LIST:BAWd:VID:AUTO ON, ON, ON, ON, ON, ON SEM:OFFS2:LIST:BAWd:VID:AUTO?</pre>
Notes	<p>Comma separated list of 6 values. Sub op code OFFSet1is for BTS, 2 for MS. Default is BTS.</p> <p>You must be in the Spectrum Analysis mode, W-CDMA mode, cdma2000 mode, TD-SCDMA mode, DTMB (CTTB) mode, DVB-T/H mode, ISDB-T mode, CMMB mode, LTE mode, LTE TDD mode 1xEVDO mode or WIMAX OFDMA mode to use this command. Use :INSTrument:SElect to set the mode.</p>
Preset	<pre>ISDB-T: 1.0kHz, 1.0kHz, 1.0kHz, 1.0kHz, 1.0kHz, 1.0kHz Other than ISDB-T: Automatically Calculated ON, ON, ON, ON, ON, ON ON, ON, ON, ON, ON, ON ISDB-T: OFF, OFF, OFF, OFF, OFF, OFF OFF, OFF, OFF, OFF, OFF, OFF</pre>
State Saved	Saved in instrument state.
Min	1 Hz
Max	50 MHz
Backwards Compatibility SCPI	[:SENSE]:SEMAsk:OFFSet[1] 2:LIST:BAWIDth:VIDeo
Initial S/W Revision	Prior to A.02.00
Modified at S/W Revision	A.02.00, A.03.00

VBW/RBW

Selects the ratio between the video and resolution bandwidths.

Key Path	Meas Setup, Offset/Limit
Mode	SA, WCDMA, C2K, WIMAX OFDMA, TD-SCDMA, 1xEVDO, DTMB (CTTB), DVB-T/H, ISDB-T, CMMB, LTE, LTETDD
Remote Command	<pre>[:SENSE] :SEMask:OFFSet [1] 2:LIST:BANDwidth:VIDeo:RATio <real>, <real>, <real>, <real>, <real>, <real> [:SENSE] :SEMask:OFFSet [1] 2:LIST:BANDwidth:VIDeo:RATio? [:SENSE] :SEMask:OFFSet [1] 2:LIST:BANDwidth:VIDeo:RATio: AUTO OFF ON 0 1, OFF ON 0 1, OFF ON 0 1, OFF ON 0 1, OFF ON 0 1, OFF ON 0 1 [:SENSE] :SEMask:OFFSet [1] 2:LIST:BANDwidth:VIDeo:RATio: AUTO?</pre>
Example	<pre>SEM:OFFS2:LIST:BAND:VID:RAT 0.1, 0.1, 0.1, 0.1, 0.1, 0.1 SEM:OFFS2:LIST:BAND:VID:RAT? SEM:OFFS2:LIST:BAND:VID:RAT:AUTO ON, ON, ON, ON, ON, ON SEM:OFFS2:LIST:BAND:VID:RAT:AUTO?</pre>
Notes	<p>Comma separated list of 6 values. OFFSet1 is for BTS, 2 for MS. Default is BTS.</p> <p>You must be in the Spectrum Analysis mode, W-CDMA mode, cdma2000 mode, TD-SCDMA mode, DTMB (CTTB) mode, DVB-T/H mode, ISDB-T mode, CMMB mode, LTE mode, LTE TDD mode, 1xEVDO mode or WIMAX OFDMA mode to use this command. Use :INSTrument:SElect to set the mode.</p>
Preset	<pre>SA, WCDMA, C2K, LTE, LTETDD: 0.01, 0.01, 0.01, 0.01, 0.01, 0.01 0.01, 0.01, 0.01, 0.01, 0.01, 0.01 WIMAX OFDMA: 0.3, 0.3, 0.3, 0.3, 0.3, 0.3 TD-SCDMA: 10, 10, 10, 10, 1, 1 10, 10, 10, 1, 1, 1 1xEVDO: 10, 10, 10, 10, 10, 10 10, 10, 10, 10, 10, 10 DTMB (CTTB): 10, 10, 10, 10, 10, 10 DVB-T/H: 10, 10, 10, 10, 10, 10 ISDB-T: 0.1, 0.1, 0.1, 0.1, 0.1, 0.1 CMMB: 10, 10, 10, 10, 10, 10 OFF, OFF, OFF, OFF, OFF, OFF OFF, OFF, OFF, OFF, OFF, OFF</pre>
State Saved	Saved in instrument state.
Min	0.00001
Max	3000000

Spectrum Emission Mask Measurement
Meas Setup

Initial S/W Revision	Prior to A.02.00
Modified at S/W Revision	A.02.00, A.03.00

Limits

Accesses a menu that enables you to set the power limits for start and stop frequencies of the selected offsets.

Key Path	Meas Setup
Initial S/W Revision	Prior to A.02.00

Abs Start

Sets the absolute power level limit at the start frequency for the selected offset. The absolute power level limit ranges from -200 to +50 dBm.

The fail condition for each offset channel is set remotely by [:SENSe]:SEMAsk:OFFSet[n]:LIST:TEST.

You can turn off (not use) specific offset channels remotely with [:SENSe]:SEMAsk:OFFSet[n]:LIST:STATe.

The SCPI query returns the five (5) sets of real values currently set to the absolute power test limits.

Key Path	Meas Setup, Offset/Limit, Limits
Mode	SA, WCDMA, C2K, WIMAX OFDMA, TD-SCDMA, 1xEVDO, DTMB (CTTB), DVB-T/H, ISDB-T, CMMB, LTE, LTE TDD
Remote Command	[:SENSe]:SEMAsk:OFFSet [1] 2:LIST:STARt:ABSolute <real>, <real>, <real>, <real>, <real>, <real> [:SENSe]:SEMAsk:OFFSet [1] 2:LIST:STARt:ABSolute?
Example	SEM:OFFS2:LIST:STAR:ABS -12.50 dBm, -12.50 dBm, -24.50 dBm, -11.50 dBm, -11.50 dBm, -11.50 dBm SEM:OFFS2:LIST:STAR:ABS?
Notes	Comma separated list of 6 values. OFFSet1 is for BTS, 2 for MS. Default is BTS. You must be in the Spectrum Analysis mode, W-CDMA mode, cdma2000 mode, TD-SCDMA mode, DTMB (CTTB) mode, DVB-T/H mode, ISDB-T mode, CMMB mode, LTE mode, LTE TDD mode 1xEVDO mode or WIMAX OFDMA mode to use this command. Use :INSTrument:SElect to set the mode.

Couplings	<p>Coupled to Abs Stop if coupling set to “Couple”, that is, the Start value is equal to the Stop value.</p> <p>If the current mode is DVB-T/H, this value will be modified automatically according to the limit type and the output power of the transmitter which is less or more than 25W.</p> <p>If the current mode is ISDB-T, this value will be modified automatically according to the limit type.</p>
Preset	<p>SA, WIMAX OFDMA: -14.00 dBm , -14.00 dBm , -26.00 dBm , -13.00 dBm , -13.00 dBm, -13.00 dBm</p> <p>WCDMA: -12.50 dBm, -12.50 dBm, -24.50 dBm, -11.50 dBm, -11.50 dBm, -11.50 dBm -69.6 dBm, -54.3 dBm, -54.3 dBm, -54.3 dBm, -54.3 dBm, -54.3 dBm</p> <p>C2K: -27.00 dBm, -27.00 dBm, -27.00 dBm, -46.00 dBm, -13.00 dBm, -13.00 dBm -70.13 dBm, -70.13 dBm, -35.00 dBm, -13.00 dBm, -13.00 dBm, -13.00 dBm</p> <p>TD-SCDMA: -28 dBm, -28 dBm, -36 dBm, -21 dBm, -21 dBm, -21 dBm -71.3 dBm, -71.3 dBm, -56.07 dBm, -56.07 dBm, -56.07 dBm, -56.07 dBm</p> <p>1xEVDO: -27.0dBm, -27.00 dBm, -27.00 dBm, -46.00 dBm, -13.00 dBm, -13.00 dBm -70.13 dBm, -70.13 dBm, -70.13 dBm, -70.13 dBm, -70.13 dBm, -70.13 dBm</p> <p>DTMB (CTTB): -14.0dBm, -14.0dBm, -26.0dBm, -13.0dBm, -13.0dBm, -13.0dBm</p> <p>DVB-T/H: 11.2dBm, -29dBm, -41dBm, -66dBm, -82dBm, -82dBm</p> <p>ISDB-T: 50.0dBm, 50.0dBm, 50.0dBm, 50.0dBm, 50.0dBm, 50.0dBm</p> <p>CMMB: 50.0dBm, 50.0dBm, 50.0dBm, 50.0dBm, 50.0dBm, 50.0dBm</p> <p>LTE, LTETDD: -5.5 dBm, -12.5 dBm, -15.0 dBm, -15.0 dBm, -15.0 dBm, -15.0 dBm -13.5dBm, -8.5dBm, -11.5dBm, -23.5dBm, -23.5dBm, -23.5dBm</p>
State Saved	Saved in instrument state.
Min	-200 dBm
Max	50 dBm
Initial S/W Revision	Prior to A.02.00
Modified at S/W Revision	A.02.00. A.03.00

Abs Stop

Sets the absolute power level limit at the stop frequency for the selected offset. The absolute power level limit ranges from -200 to +50 dBm. You can also toggle this function between couple and manual. If set to Couple, the **Abs Stop** power level limit is coupled to **Abs Start** to result in a flat limit line. If set to Man, Abs Start and Abs Stop take different values to result in a sloped limit line.

The SCPI query returns the five (5) sets of real values currently set to the offset stop absolute power

Spectrum Emission Mask Measurement
Meas Setup

limits.

Key Path	Meas Setup, Offset/Limit, Limits
Mode	SA, WCDMA, C2K, WIMAX OFDMA, TD-SCDMA, 1xEVDO, DTMB (CTTB), DVB-T/H, ISDB-T, CMMB, LTE, LTETDD
Remote Command	<pre>[:SENSe] :SEMAsk:OFFSet [1] 2 :LIST:STOP:ABSolute <real>, <real>, <real>, <real>, <real>, <real> [:SENSe] :SEMAsk:OFFSet [1] 2 :LIST:STOP:ABSolute? [:SENSe] :SEMAsk:OFFSet [1] 2 :LIST:STOP:ABSolute:COUPle ON OFF 1 0, ON OFF 1 0, ON OFF 1 0, ON OFF 1 0, ON OFF 1 0, ON OFF 1 0 [:SENSe] :SEMAsk:OFFSet [1] 2 :LIST:STOP:ABSolute:COUPle?</pre>
Example	<pre>SEM:OFFS:LIST:STOP:ABS -12.50 dBm, -24.50 dBm, -24.50 dBm, -11.50 dBm, -11.50 dBm, -11.50 dBm SEM:OFFS1:LIST:STOP:ABS? SEM:OFFS:LIST:STOP:ABS:COUP ON, OFF, ON, ON, ON, ON SEM:OFFS:LIST:STOP:ABS:COUP?</pre>
Notes	<p>Comma separated list of 6 values. OFFSet1 is for BTS, 2 for MS. Default is BTS.</p> <p>You must be in the Spectrum Analysis mode, W-CDMA mode, cdma2000 mode, TD-SCDMA mode, DTMB (CTTB) mode, DVB-T/H mode, ISDB-T mode, CMMB mode, LTE mode, LTE TDD mode 1xEVDO mode or WIMAX OFDMA mode to use this command. Use :INSTRument:SELEct to set the mode.</p>
Couplings	<p>Coupled to Abs Start if coupling set to “Couple”, that is, the Stop value is equal to the Start value.</p> <p>If the current mode is DVB-T/H, this value will be modified automatically according to the limit type and the output power of the transmitter which is less or more than 25W.</p> <p>If the current mode is ISDB-T, this value will be modified automatically according to the limit type.</p>

Preset	<p>SA, WIMAX OFDMA: -14.00 dBm, -26.00 dBm, -26.00 dBm, -13.00 dBm, -13.00 dBm, -13.00 dBm</p> <p>WCDMA: -12.50 dBm, -24.50 dBm, -24.50 dBm, -11.50 dBm, -11.50 dBm, -11.50 dBm -69.6 dBm, -54.3 dBm, -54.3 dBm, -54.3 dBm, -54.3 dBm, -54.3 dBm</p> <p>C2K: -27.00 dBm, -27.00 dBm, -27.00 dBm, -46.00 dBm, -13.00 dBm, -13.00 dBm -70.13 dBm, -70.13 dBm, -35.00 dBm, -13.00 dBm, -13.00 dBm, -13.00 dBm</p> <p>TD-SCDMA: -28 dBm, -36 dBm, -36 dBm, -21 dBm, -21 dBm, -21 dBm -71.3 dBm, -71.3 dBm, -56.07 dBm, -56.07 dBm, -56.07 dBm, -56.07 dBm</p> <p>1xEVDO: -27dBm, -27.00 dBm, -27.00 dBm, -46.00 dBm, -13.00 dBm, -13.00 dBm -70.13 dBm, -70.13 dBm, -70.13 dBm, -70.13 dBm, -70.13 dBm, -70.13 dBm</p> <p>DTMB (CTTB): -14.0dBm, -26.0dBm, -26.0dBm, -13.0dBm, -13.0dBm, -13.0dBm</p> <p>DVB-T/H: -29dBm, -41dBm, -66dBm, -82dBm, -82dBm, -82dBm</p> <p>ISDB-T: 50.0dBm, 50.0dBm, 50.0dBm, 50.0dBm, 50.0dBm, 50.0dBm</p> <p>CMMB: 50.0dBm, 50.0dBm, 50.0dBm, 50.0dBm, 50.0dBm, 50.0dBm</p> <p>LTE, LTETDD:-12.5 dBm, -12.5 dBm, -15.0 dBm, -15.0 dBm, -15.0 dBm, -15.0 dBm -13.5 dBm, -8.5 dBm, -11.5 dBm, -23.5 dBm, -23.5 dBm, -23.5 dBm</p> <p>SA,WIMAX OFDMA: ON, OFF, ON, ON, ON, ON, ON</p> <p>WCDMA: ON, OFF, ON, ON, ON, ON ON, ON, ON, ON, ON, ON</p> <p>C2K: ON, ON, ON, ON, ON, OFF ON, ON, ON, ON, ON, OFF</p> <p>TD-SCDMA: ON, OFF, ON, ON, ON, ON ON, ON, ON, ON, ON, ON</p> <p>1xEVDO: ON, ON, ON, ON, ON, OFF ON, ON, ON, ON, ON, OFF</p> <p>DTMB (CTTB): ON, OFF, ON, ON, ON, ON</p> <p>DVB-T/H: OFF, OFF, OFF, OFF, OFF, OFF</p> <p>ISDB-T: OFF, OFF, OFF, OFF, OFF, OFF</p> <p>CMMB: OFF, OFF, OFF, OFF, OFF, OFF</p> <p>LTE, LTETDD: OFF, ON, ON, ON, ON, ON, ON ON, ON, ON, ON, ON, ON</p>
State Saved	Saved in instrument state.
Min	-200 dBm
Max	50 dBm
Initial S/W Revision	Prior to A.02.00
Modified at S/W Revision	A.02.00, A.03.00

Spectrum Emission Mask Measurement
Meas Setup

Rel Start

Sets a relative power level limit at the start frequency for the selected offset. The relative power level limit ranges from –200 to +50 dBc.

The fail condition is set remotely by [:SENSE]:SEMAsk:OFFSet[n]:LIST:TEST for each offset channel test.

You can turn off (not use) specific offset channels remotely with [:SENSE]:SEMAsk:OFFSet[n]:LIST:STATe.

The SCPI query returns the five (5) sets of real values currently set to the relative power test limits.

Key Path	Meas Setup, Offset/Limit, Limits
Mode	SA, WCDMA, C2K, WIMAX OFDMA, TD-SCDMA, 1xEVDO, DTMB (CTTB), DVB-T/H, ISDB-T, CMMB, LTE, LTETDD
Remote Command	[:SENSE]:SEMAsk:OFFSet [1] 2:LIST:STARt:RCARrier <rel_ampl>, <rel_ampl>, <rel_ampl>, <rel_ampl>, <rel_ampl>, <rel_ampl> [:SENSE]:SEMAsk:OFFSet [1] 2:LIST:STARt:RCARrier?
Example	SEM:OFFS:LIST:STAR:RCAR –30.00 dB, –30.00 dB, –30.00 dB, –30.00 dB, –30.00 dB, –30.00 dB SEM:OFFS:LIST:STAR:RCAR?
Notes	See the following table for the default values for each Radio Standard. Comma separated list of 6 values. OFFSet1 is for BTS, 2 for MS. Default is BTS. You must be in the Spectrum Analysis mode, W-CDMA mode, cdma2000 mode, TD-SCDMA mode, DTMB (CTTB) mode, DVB-T/H mode, ISDB-T mode, CMMB mode, LTE mode, LTE TDD mode 1xEVDO mode or WIMAX OFDMA mode to use this command. Use :INSTrument:SELEct to set the mode.
Couplings	Coupled to Rel Stop is coupling set to “Couple”, that is, Start is made the same as Stop. If the current mode is DVB-T/H, this value will be modified automatically according to the limit type the output power of the transmitter which is less or more than 25W. If the current mode is ISDB-T, this value will be modified automatically according to the limit type.

Preset	SA: -30.00 dB, -30.00 dB, -30.00 dB, -30.00 dB, -30.00 dB, -30.00 dB WCDMA: -30.00 dB, -30.00 dB, -30.00 dB, -30.00 dB, -30.00 dB, -30.00 dB, -33.73 dB, -34.00 dB, -37.50 dB, -47.50 dB, -47.50 dB, -47.50 dB C2K: -45.00 dB, -45.00 dB, -55.00 dB, -55.00 dB, -55.00 dB, -55.00 dB, -42.00 dB, -54.00 dB, -54.00 dB, -54.00 dB, -54.00 dB, -54.00 dB WIMAX OFDMA: 0 dB, -25 dB, -32 dB, -50 dB, -50 dB, -50 dB TD-SCDMA: -54.00 dB, -54.00 dB, -62.00 dB, -47.00 dB, -47.00 dB, -47.00 dB, -35.00 dB, -49.00 dB, -49.00 dB, -49.00 dB, -49.00 dB, -49.00 dB 1xEVDO: -45dBc, -45.00 dB, -55.00 dB, -55.00 dB, -55.00 dB, -55.00 dB, -42dBc, -54.00 dB, -54.00 dB, -54.00 dB, -54.00 dB, -54.00 dB DTMB (CTTB): -32.8dB, -83dB, -95dB, -120dB, -120dB, -120dB DVB-T/H: -30dB, -30dB, -30dB, -30dB, -30dB, -30dB ISDB-T: -27.4dB, -47.4dB, -54.4dB, XXX, 50dB, 50dB; XXX is coupled with the total power reference, it is -57.4dB when $P \leq 0.025W$, -67.4dB when $P = 0.25W$, $-(73.4 + 10\log P)$ dB when $0.25W < P \leq 2.5W$ or $0.025W < P < 0.25W$, -77.4dB when $P > 2.5W$. CMMB: -37dB, -72dB, -84dB, -90dB, -90dB, -90dB LTE, LTETDD: 0dB, 0dB, 0dB, 0dB, 0dB, 0dB, 0dB, 0dB, 0dB, 0dB, 0dB, 0dB
State Saved	Saved in instrument state.
Min	-200 dB
Max	50 dB
Initial S/W Revision	Prior to A.02.00
Modified at S/W Revision	A.02.00, A.03.00

Rel Stop

Sets a relative power level limit at the stop frequency for the selected offset. The relative power level limit ranges from -200 to +50 dBc.

The fail condition is set remotely by [:SENSE]:SEMask:OFFSet[n]:LIST:TEST for each offset channel.

You can turn off (not use) specific offset channels remotely with [:SENSE]:SEMask:OFFSet[n]:LIST:STATE.

The SCPI query returns the five (5) sets of real values currently set to the offset stop relative power limits.

Key Path	Meas Setup, Offset/Limit, Limits
Mode	SA, WCDMA, C2K, WIMAX OFDMA, TD-SCDMA, 1xEVDO, DTMB (CTTB), DVB-T/H, ISDB-T, CMMB, LTE, LTETDD

Spectrum Emission Mask Measurement
Meas Setup

<p>Remote Command</p>	<pre>[:SENSe] :SEMAsk:OFFSet [1] 2:LIST:STOP:RCARrier <rel_ampl>, <rel_ampl>, <rel_ampl>, <rel_ampl>, <rel_ampl>, <rel_ampl> [:SENSe] :SEMAsk:OFFSet [1] 2:LIST:STOP:RCARrier? [:SENSe] :SEMAsk:OFFSet [1] 2:LIST:STOP:RCARrier:COUPle ON OFF 1 0, ON OFF 1 0, ON OFF 1 0, ON OFF 1 0, ON OFF 1 0, ON OFF 1 0 [:SENSe] :SEMAsk:OFFSet [1] 2:LIST:STOP:RCARrier:COUPle?</pre>
<p>Example</p>	<pre>SEM:OFFS:LIST:STOP:RCAR -30.00 dB, -30.00 dB, -30.00 dB, -30.00 dB, -30.00 dB, -30.00 dB SEM:OFFS:LIST:STOP:RCAR? SEM:OFFS:LIST:STOP:RCAR:COUP ON, ON, ON, ON, ON, ON SEM:OFFS:LIST:STOP:RCAR:COUP?</pre>
<p>Notes</p>	<p>See the following table for the default values for each Radio Standard.</p> <p>Comma separated list of 6 values. OFFSet1 is for BTS, 2 for MS. Default is BTS.</p> <p>You must be in the Spectrum Analysis mode, W-CDMA mode, cdma2000 mode, TD-SCDMA mode, DTMB (CTTB) mode, DVB-T/H mode, ISDB-T mode, CMMB mode, LTE mode, LTE TDD mode 1xEVDO mode or WIMAX OFDMA mode to use this command. Use :INSTRument:SElect to set the mode.</p>
<p>Couplings</p>	<p>Coupled to Rel Start if coupling set to “Couple”, that is, Start is made the same as Stop.</p> <p>If the current mode is DVB-T/H, this value will be modified automatically according to the limit type and the output power of the transmitter which is less or more than 25W.</p> <p>If the current mode is ISDB-T, this value will be modified automatically according to the limit type.</p>

Preset	<p>SA: -30.00 dB, -30.00 dB, -30.00 dB, -30.00 dB, -30.00 dB, -30.00 dB</p> <p>WCDMA: -30.00 dB, -30.00 dB, -30.00 dB, -30.00 dB, -30.00 dB, -30.00 dB -48.28 dB, -37.50 dB, -47.50 dB, -47.50 dB, -47.50 dB, -47.50 dB</p> <p>C2K: -45.00 dB, -45.00 dB, -55.00 dB, -55.00 dB, -55.00 dB, -55.00 dB -42.00 dB, -54.00 dB, -54.00 dB, -54.00 dB, -54.00 dB, -54.00 dB</p> <p>WIMAX OFDMA: -25 dB, -32 dB, -50 dB, -50 dB, -50 dB, -50 dB</p> <p>TD-SCDMA: -54.00 dB, -62.00 dB, -62.00 dB, -47.00 dB, -47.00 dB, -47.00 dB -49.00 dB, -64.00 dB, -49.00 dB, -49.00 dB, -49.00 dB, -49.00 dB</p> <p>1xEVDO: -45dB, -45.00 dB, -55.00 dB, -55.00 dB, -55.00 dB, -55.00 dB -42dB, -54.00 dB, -54.00 dB, -54.00 dB, -54.00 dB, -54.00 dB</p> <p>DTMB (CTTB): -83dB, -95dB, -120dB, -120dB, -120dB, -120dB</p> <p>DVB-T/H: -73dB, -85dB, -110dB, -126dB, -126dB, -126dB</p> <p>ISDB-T: -47.4dB, -54.4dB, XXX, 50dB, 50dB, 50dB; XXX is coupled with the total power reference P, it is -57.4dB when $P \leq 0.025W$, -67.4dB when $P = 0.25W$, $-(73.4 + 10\log P)$dB when $0.25W < P \leq 2.5W$ or $0.025W < P < 0.25W$, -77.4dB when $P > 2.5W$.</p> <p>CMMB: -72dB, -84dB, -90dB, -90dB, -90dB, -90dB</p> <p>LTE, LTETDD: -0dB, -0dB, -0dB, -0dB, -0dB, -0dB</p> <p>SA: ON, ON, ON, ON, ON, ON</p> <p>WCDMA: ON, ON, ON, ON, ON, ON OFF, OFF, OFF, ON, ON, ON</p> <p>C2K: ON, ON, ON, ON, ON, OFF ON, ON, ON, ON, ON, OFF</p> <p>WIMAX OFDMA: OFF, OFF, OFF, ON, ON, ON OFF, OFF, OFF, ON, ON, ON</p> <p>TD-SCDMA: ON, OFF, ON, ON, ON, ON OFF, OFF, ON, ON, ON, ON</p> <p>1xEVDO: ON, ON, ON, ON, ON, OFF ON, ON, ON, ON, ON, OFF</p> <p>DTMB (CTTB): OFF, OFF, OFF, OFF, OFF, OFF</p> <p>DVB-T/H: ON, ON, ON, ON, ON, ON</p> <p>ISDB-T: OFF, OFF, OFF, OFF, OFF, OFF</p> <p>CMMB: OFF, OFF, OFF, OFF, OFF, OFF</p> <p>LTE, LTETDD: ON, ON, ON, ON, ON, ON</p>
State Saved	Saved in instrument state.
Min	-200 dB
Max	50 dB
Initial S/W Revision	Prior to A.02.00
Modified at S/W Revision	A.02.00, A.03.00

Fail Mask

Selects one of the logic keys for fail conditions between the measurement results and the test limits:

Absolute and **Relative** both check the results against the respective limit.

OR checks against both limits, failing if either of the limits is broken.

AND will only display a fail if both of the limits are broken.

The absolute or relative power limit value for each offset channel can be set remotely with
[:SENSe]:SEMask:OFFSet[n]:LIST:ABSolute or [:SENSe]:SEMask:OFFSet[n]:LIST:RCARrier.

You can turn off (not use) specific offset channels remotely with
[:SENSe]:SEMask:OFFSet[n]:LIST:STATe.

Key Path	Meas Setup, Offset/Limit, Limits
Mode	SA, WCDMA, C2K, WIMAX OFDMA, TD-SCDMA, 1xEVDO, DTMB (CTTB), DVB-T/H, ISDB-T, CMMB, LTE, LTETDD
Remote Command	[:SENSe]:SEMask:OFFSet [1] 2 :LIST:TEST ABSolute AND OR RELative, ABSolute AND OR RELative, ABSolute AND OR RELative, ABSolute AND OR RELative, ABSolute AND OR RELative, ABSolute AND OR RELative, ABSolute AND OR RELative [:SENSe]:SEMask:OFFSet [1] 2 :LIST:TEST?
Example	SEM:OFFS:LIST:TEST ABS, ABS, ABS, ABS, ABS, ABS SEM:OFFS:LIST:TEST?
Notes	See the following table for the default values for each Radio Standard. Comma separated list of 6 values. OFFSet1 is for BTS, 2 for MS. Default is BTS. You must be in the Spectrum Analysis mode, W-CDMA mode, cdma2000 mode, TD-SCDMA mode, DTMB (CTTB) mode, DVB-T/H mode, ISDB-T mode, CMMB mode, LTE mode, LTE TDD mode 1xEVDO mode or WIMAX OFDMA mode to use this command. Use :INSTrument:SElect to set the mode.
Couplings	None If the current mode is DVB-T/H, this value will be modified automatically according to the limit type and the output power of the transmitter which is less or more than 25W.

Preset	SA: ABS, ABS, ABS, ABS, ABS, ABS WCDMA: ABS, ABS, ABS, ABS, ABS, ABS, ABS AND, AND, AND, AND, AND, AND C2K: REL, REL, REL, ABS, REL, REL AND, AND, ABS, REL, REL, REL WIMAX OFDMA: REL, REL, REL, REL, REL, REL REL, REL, REL, REL, REL, REL TD-SCDMA: ABS, ABS, ABS, ABS, ABS, ABS, ABS AND, AND, AND, AND, AND, AND 1xEVDO: REL, REL, REL, ABS, REL, REL AND, AND, AND, OR, AND, AND DTMB (CTTB): REL, REL, REL, REL, REL, REL DVB-T/H: ABS, ABS, ABS, ABS, ABS, ABS ISDB-T: REL, REL, REL, REL, REL, REL CMMB: REL, REL, REL, REL, REL, REL, LTE: ABS, ABS, ABS, ABS, ABS, ABS LTETDD: ABS, ABS, ABS, ABS, ABS, ABS
State Saved	Saved in instrument state.
Range	Absolute Relative Abs AND Rel Abs OR Rel
Initial S/W Revision	Prior to A.02.00
Modified at S/W Revision	A.02.00, A.03.00

Method

Sets the measurement method

Integ BW-enables you to set the channel integration bandwidth.

RRC Weight-selects Root Raised Cosine (RRC) filtering of the carriers and all adjacent channels. The α value (rolloff) for the filter is set to the value of the Filter Alpha parameter.

Key Path	Meas Setup
Mode	SA, WCDMA, WIMAX OFDMA, TD-SCDMA, DTMB (CTTB), DVB-T/H, ISDB-T, CMMB, LTE, LTETDD
Remote Command	[:SENSe] :SEMAsk:FILTer [:RRC] [:STATe] OFF ON 0 1 [:SENSe] :SEMAsk:FILTer [:RRC] [:STATe] ?
Example	SEM:FILT ON SEM:FILT?

Spectrum Emission Mask Measurement
Meas Setup

Notes	For the CDMA2K and CDMA1xEVDO mode, this key is not available. 1 ON = RRC Weight, 0 OFF = IntegBW You must be in the Spectrum Analysis mode, DTMB (CTTB) mode, DVB-T/H mode, ISDB-T mode, CMMB mode, LTE mode, LTE TDD mode W-CDMA mode or TD-SCDMA mode to use this command. Use :INSTrument:SElect to set the mode.
Preset	SA, WIMAX OFDMA, DVB-T/H, ISDB-T, CMMB, LTE, LTETDD: OFF WCDMA, TD-SCDMA, DTMB (CTTB): ON
State Saved	Saved in instrument state.
Range	RRCWeight IntegBW
Initial S/W Revision	Prior to A.02.00
Modified at S/W Revision	A.02.00, A.03.00

Filter Alpha

Sets the alpha value for the RRC Filter.

Key Path	Meas Setup
Mode	SA, WCDMA, WIMAX OFDMA, TD-SCDMA, DTMB (CTTB), DVB-T/H, ISDB-T, CMMB, LTE, LTETDD
Remote Command	[:SENSE] :SEMAsk:FILTer [:RRC] :ALPHa <real> [:SENSE] :SEMAsk:FILTer [:RRC] :ALPHa?
Example	SEM:FILT:ALPH 0.3 SEM:FILT:ALPH?
Notes	For the CDMA2K and CDMA1xEVDO mode, this key is not available. You must be in the Spectrum Analysis mode, DTMB (CTTB) mode, DVB-T/H mode, ISDB-T mode, CMMB mode, LTE mode, LTE TDD mode, W-CDMA mode or TD-SCDMA mode to use this command. Use :INSTrument:SElect to set the mode.
Preset	0.22 DTMB (CTTB): 0.05
State Saved	Saved in instrument state.
Min	0.01
Max	1.0
Initial S/W Revision	Prior to A.02.00
Modified at S/W Revision	A.02.00, A.03.00

Meas Preset

Restores all the measurement parameters to their default values.

Key Path	Meas Setup
Mode	SA, WCDMA, C2K, WIMAX OFDMA, TD-SCDMA, 1xEVDO, DTMB (CTTB), DVB-T/H, ISDB-T, CMMB, LTE, LTETDD
Remote Command	:CONFIgure:SEMask
Example	CONF:SEM
Notes	You must be in the Spectrum Analysis mode, W-CDMA mode, cdma2000 mode, TD-SCDMA mode, DTMB (CTTB) mode, DVB-T/H mode, ISDB-T mode, CMMB mode, LTE mode, LTE TDD mode 1xEVDO mode or WIMAX OFDMA mode to use this command. Use :INSTrument:SElect to set the mode.
Couplings	Selecting Meas Preset will restore all measurement parameters to their default values.
Initial S/W Revision	Prior to A.02.00
Modified at S/W Revision	A.02.00, A.03.00

Limits State(Only for TD-SCDMA)

The key “Limits State” is only displayed in the TD-SCDMA mode. The mask lines could be drawn in two different ways, according to the 3GPP standard for the base station when the key’s value is “Std”; or by the user-defined specifications listed in the Offset/Limits menu.

Key Path	Meas Setup
Mode	TD-SCDMA
Remote Command	[:SENSe] :SEMask:LIMits STD MAN [:SENSe] :SEMask:LIMits?
Example	SEM:LIM STD SEM:LIM?
Notes	You must be in the TD-SCDMA mode to use this command. Use :INSTrument:SElect to set the mode.
Dependencies	See Couplings

Spectrum Emission Mask Measurement
Meas Setup

Couplings	<p>When the value of the “Limits” key is Std, the parameters displayed on the Offset/Limits panel will be modified depending on the carrier power, which corresponds to the measurement standard of the base station. All the keys except “Offset”, “Relative Atten”, “Offset Side” and “Limits” displayed on the “Offset/Limits” panel will be grayed out. All the keys displayed on the “Limits” panel will be grayed out as well.</p> <p>When the value of the “Limits” key is Man, all of the previous manual specifications will be restored, and the keys that were previously grayed out will be enabled again.</p>
Preset	MAN
State Saved	Saved in instrument state.
Range	STD MAN
Initial S/W Revision	Prior to A.02.00

Limit Type (Only for DVB-T/H)

This key “Limits Type” is only for DVB-T/H mode. The mask lines could be drawn in three different ways:

1. according to the non-critical case standard in ETSI 302–296 when the key’s value is “Non-Critical”
2. according to the critical case standard in ETSI 302–296 when the key’s value is “Critical”
3. specifications listed in the Offset/Limits menu or by the user-defined when the key’s value is “Manual”.

Key Path	Meas Setup
Mode	DVB-T/H
Remote Command	[:SENSe]:SEMask:LIMits:TYPE MANual NONCritical CRITical [:SENSe]:SEMask:LIMits:TYPE?
Example	SEM:LIM:TYPE NONC SEM:LIM:TYPE?
Notes	You must be in the DVB-T/H mode to use this command. Use :INSTrument:SElect to set the mode.

Couplings	<ol style="list-style-type: none"> 1. When current radio bandwidth is 5 MHz or 6 MHz, this key only has one option: Manual. The “Non-Critical” and “Critical” keys will be grayed out. So the default value is Manual after measurement preset. 2. When current radio bandwidth is 7 MHz or 8 MHz, this key has three options: Manual, Non-Critical and Critical. The default value is Non-Critical after measurement preset. <ol style="list-style-type: none"> a. When the value of the “Limit Type” key is Non-Critical, the parameters displayed on the Offset/Limits panel will be modified automatically depending on the carrier power, according to the Non-critical case limits definition in ETSI 302–296, and the keys under the Offset/Limit except “Offset”, “Offset Side” and “Limits” will be grayed out. Meanwhile all the keys displayed on the “Limits” panel will be grayed out as well. b. When the value of the “Limit Type” key is Critical, the parameters displayed on the Offset/Limits panel will be modified automatically depending on the carrier power, according to the critical case limits definition in ETSI 302–296, and the keys under the Offset/Limit except “Offset”, “Offset Side” and “Limits” will be grayed out. Meanwhile all the keys displayed on the “Limits” panel will be grayed out as well. c. When the value of the “Limit Type” key is Manual, all of the previous manual specifications will be restored, and the keys that were previously grayed out will be enabled again.
Preset	NONCritical (if current radio bandwidth is 7MHz or 8MHz) Manual (if current radio bandwidth is 5MHz or 6MHz)
State Saved	Saved in instrument state.
Range	Manual Non-Critical Critical
Initial S/W Revision	A.02.00

Limit Type (Only for ISDB-T)

This key “Limits Type” is only for ISDB-T mode. The mask lines could be drawn in six different ways as follows:

1. JEITA, Limit Masks defined in ARIB-STD B31 Version 1.7, Transmission System For Digital Terrestrial Television Broadcasting
2. Non-critical case defined in Brazil ABNT NBR15601, Digital terrestrial television – Transmission systems
3. Sub-critical case defined in Brazil ABNT NBR15601
4. Critical case defined in Brazil ABNT NBR15601
5. ISDB-Tsb case defined in ARIB STD-B29, “Transmission System for Digital Terrestrial Sound Broadcasting”
6. User-defined

Spectrum Emission Mask Measurement
Meas Setup

The mask lines for JEITA are listed in “JEITA” on page 591.

The mask lines for 2 (Non-critical case), 3 (Sub-critical case),4 (Critical case) are listed in the following table.

Separation in relation to the digital signal central carrier	Minimum attenuation in relation to average power, measured at carrier central frequency		
	Non-critical mask	Sub-critical mask	Critical mask
±2.79 MHz	0.0 dB	0.0 dB	0.0 dB
±2.86 MHz	20.0 dB	20.0 dB	20.0 dB
±3.00 MHz	27.0 dB	34.0 dB	34.0 dB
±3.15 MHz	36.0 dB	43.0 dB	50.0 dB
±4.5 MHz	53.0 dB	60.0 dB	67.0 dB
±9.0 MHz	83.0 dB	90.0 dB	97.0 dB
±15.0 MHz	83.0 dB	90.0 dB	97.0 dB

The mask lines for 5 (ISDB-Tsb case) are listed below.

1-Segment

Difference from carrier frequency	Attenuation from the average power, P	Specification
±220 kHz	-16.3 dB/10 kHz	upper limit
±290 kHz	-36.3 dB/10 kHz	upper limit
±360 kHz	-46.3 dB/10 kHz	upper limit
±1170 kHz	-52.0 dB/10 kHz; (P≤0.5 W) -(53.6 + 5.6logP) dB/10 kHz; (0.5 W<P≤5.0 W) -57.6 dB/10 kHz; (P>5.0 W)	upper limit

3-Segment

Difference from carrier frequency	Attenuation from the average power, P	Specification
±650 kHz	-21.0 dB/10 kHz	upper limit
±720 kHz	-41.0 dB/10 kHz	upper limit
±790 kHz	-51.0 dB/10 kHz	upper limit

Difference from carrier frequency	Attenuation from the average power, P	Specification
±2220 kHz	-61.0 dB/10 kHz; (P≤0.5 W) -61.0+10log(P/0.5) dB/10 kHz; (0.5 W<P≤5.0 W) -71.0 dB/10 kHz; (P>5.0 W)	upper limit

Key Path	Meas Setup
Mode	ISDB-T
Remote Command	[:SENSE]:SEMAsk:LIMits:TYPE MANual JEITa ANONcriticalASUBcritical ACritical TSB [:SENSE]:SEMAsk:LIMits:TYPE?
Example	SEM:LIM:TYPE JEIT SEM:LIM:TYPE?
Notes	You must be in the ISDB-T mode to use this command. Use :INSTrument:SElect to set the mode.

Couplings	<ol style="list-style-type: none">1. When current radio standard is ISDB-T, this key has five options: “Manual”, “JEITA”, “ABNT Non-Critical”, “ABNT Sub-Critical” and “ABNT Critical”. The “ISDB-Tsb” key will be grayed out. The default value is “JEITA” after measurement preset<ol style="list-style-type: none">a. When the value of the “Limit Type” key is “JEITA”, there are four options: “Auto Sense”, “30dB Mask”, “40dB Mask” and “50dB Mask”. If “Auto Sense” is selected, the parameters displayed on Offset/Limits panel will be modified automatically depending on the total reference power, according to the spectrum mask definition in ARIB-STD B31, Version 1.7, and all the keys under the Offset/Limit except “Select Offset” and “Limits” will be grayed out. If “30dB Mask” key is selected, the 30dB mask will be applied. If “40dB Mask” key is selected, the 40dB mask will be applied. If “50dB Mask” key is selected, the 50dB mask will be applied.b. When the value of the “Limit Type” key is “ABNT Non-Critical”, the parameters displayed on Offset/Limits panel will be modified automatically according to the Non-critical mask definition in Brazil “ABNT NBR 15601, and all keys under the Offset/Limit except “Select Offset” and “Limits” will be grayed out.c. When the value of the “Limit Type” key is “ABNT Sub-Critical”, the parameters displayed on Offset/Limits panel will be modified automatically according to the Sub-critical mask definition in Brazil “ABNT NBR 15601, and the keys under the Offset/Limit except “Select Offset” and “Limits” will be grayed out.d. When the value of the “Limit Type” key is “ABNT Critical”, the parameters displayed on Offset/Limits panel will be modified automatically according to the Critical mask definition in Brazil “ABNT NBR 15601, and all keys under the Offset/Limit except “Select Offset” and “Limits” will be grayed out.e. When the value of the “Limit Type” key is “Manual”, the parameters displayed on the Offset/Limits panel can be modified manually. When changing the “Limit Type” key from “Manual” to others, the current settings will be stored.2. When current radio standard is ISDB-Tsb, this key has only two options: “Manual” and “ISDB-Tsb”. The default value is “ISDB-Tsb” after measurement preset.<ol style="list-style-type: none">a. When the value of the “Limit Type” key is “ISDB-Tsb”, the parameters displayed on the Offset/Limits panel will be modified automatically depending on the output signal power and the value of “Segment Number” under “Mode Setup” panel, according to the spectrum mask definition in ARIB STD-B29, and all keys under the Offset/Limit except “Select Offset” and “Limits” will be grayed out.b. When the value of the “Limit Type” key is “Manual”, the parameters displayed on the Offset/Limits panel can be modified manually. When changing the “Limit Type” key from “Manual” to others, the current settings will be stored.
-----------	---

Preset	JEITa (if current radio standard is ISDB-T) TSB (if current radio standard is ISDB-Tsb)
State Saved	Saved in instrument state.
Range	Manual ABNT Non-Critical ABNT Sub-Critical ABNT Critical I SDB-Tsb
Initial S/W Revision	A.03.00
Modified at S/W Revision	A.06.00

JEITA

Selects JEITA as limit type, which means the Limit Masks defined in ARIB-STD B31 Version 1.7 will be used. Four options, Auto Sense, 30dB Mask, 40dB Mask, 50dB Mask, are available, which refer to four types of limitations for ± 4.36 MHz difference from carrier frequency.

Difference from carrier frequency	Attenuation from the average power, P	Specification
± 2.79 MHz	-27.4 dB/10 kHz	upper limit
± 2.86 MHz	-47.4 dB/10 kHz	upper limit
± 3.00 MHz	-54.4 dB/10 kHz	upper limit
± 4.36 MHz	$P \leq 0.025$ W, -57.4 dB/10 kHz 0.025 W < $P < 0.25$ W, - $(73.4 + 10 \cdot \log P)$ dB/10 kHz $P = 0.25$ W, -67.4 dB/10 kHz 0.25 W < $P \leq 2.5$ W, - $(73.4 + 10 \cdot \log P)$ dB/10 kHz $P > 2.5$ W, -77.4 dB/10 kHz	upper limit

Auto Sense means the instrument will auto-detect average power P to set the limit for ± 4.36 MHz frequency offset.

30dB Mask means the attenuation from the average power at ± 4.36 MHz frequency offset is -57.4 dB/10 kHz.

40dB Mask means the attenuation from the average power at ± 4.36 MHz frequency offset is -67.4 dB/10 kHz.

50dB Mask means the attenuation from the average power at ± 4.36 MHz frequency offset is -77.4 dB/10 kHz.

Spectrum Emission Mask Measurement
Meas Setup

The following table lists the cases to use the four masks.

Channel Power P	Is adjacent channel used for analog TV?	Is the Analog TV power more than or equal to ten times the channel power?	Attenuation at ± 4.36 MHz frequency offset	Mask to be used
$P \geq 2.5$ W	Yes/No	Yes/No	-77.4 dB/10 kHz	Auto Sense
2.5 W $\geq P > 0.25$ W	No	None	$-(73.4 + 10\log P)$ dB/10 KHz	Auto Sense
	Yes	Yes	$-(73.4 + 10\log P)$ dB/10 KHz	Auto Sense
	Yes	No	-77.4 dB/10 kHz	50dB Mask
0.25 W $\geq P > 0.025$ W	No	None	$-(73.4 + 10\log P)$ dB/10 KHz	Auto Sense
	Yes	Yes	-67.4 dB/10 kHz	40dB Mask
	Yes	No	-77.4 dB/10 kHz	50dB Mask
0.025 W $\geq P$	No	None	-57.4 dB/10 kHz	Auto Sense
	Yes	Yes	-67.4 dB/10 kHz	40dB Mask
	Yes	No	-77.4 dB/10 kHz	50dB Mask

Key Path	Meas Setup, Limit Type
Mode	ISDB-T
Remote Command	[:SENSE] :SEMAsk:LIMits:TYPE:JEITA ASENse J30Mask J40Mask J50Mask [:SENSe] :SEMAsk:LIMits:TYPE:JEITA?
Example	SEM:LIM:TYPE:JEIT ASEN SEM:LIM:TYPE:JEIT?
Notes	You must be in the ISDB-T mode to use this command. Use :INSTrument:SElect to set the mode.
Couplings	<ol style="list-style-type: none"> 1. If “Auto Sense” is selected, the parameters displayed on the Offset/Limits panel will be modified automatically depending on the total reference power, according to the spectrum mask definition in ARIB-STD B31, Version 1.7, and the keys under the Offset/Limit except “Select Offset” and “Limits” will be grayed out. 2. If “30dB Mask” is selected, the 30dB mask will be applied. 3. If “40dB Mask” is selected, the 40dB mask will be applied. 4. If “50dB Mask” is selected, the 50dB mask will be applied.
Preset	ASENse
State Saved	Saved in instrument state.
Range	Auto Sense 30dB Mask 40dB Mask 50dB Mask

Initial S/W Revision	A.06.00
----------------------	---------

Offset Frequency Define

This key allows you to select “Offset” definition. Each standard defines each “Offset” from Carrier.

- MeasBW Edge means the edge of resolution band width that is represented by Meas BW and Res BW settings. Actual center frequency of MeasBW and the limit line have $\frac{1}{2}$ MeasBW offset when the MeasBW Edge is selected.

3GPP2 requires the “Carrier Center to MeasBW Edge” definition. And LTE conformance test requires “Carrier Edge to MeasBW Center” and/or “Carrier Edge to MeasBW Edge” definition

- CTOCenter – From carrier center to the center of offset measuring filter*
- CTOEdge - From carrier center to the nominal -3dB point of the offset measuring filter* closer to the carrier
- ETOCenter – From Center Frequency - Span of Ref Channel / 2 (for lower offset), Center Frequency + Span of Ref Channel / 2 (for upper offset) of the carrier closest to each offset to the center of offset measuring filter*
- ETOEdge - From Center Frequency - Span of Ref Channel / 2 (for lower offset), Center Frequency + Span of Ref Channel / 2 (for upper offset) of the carrier closest to each offset to the nominal -3dB point of the offset measuring filter* closer to the carrier
- *Measuring filter = Meas BW (N x Res BW)

Spectrum Emission Mask Measurement
 Meas Setup

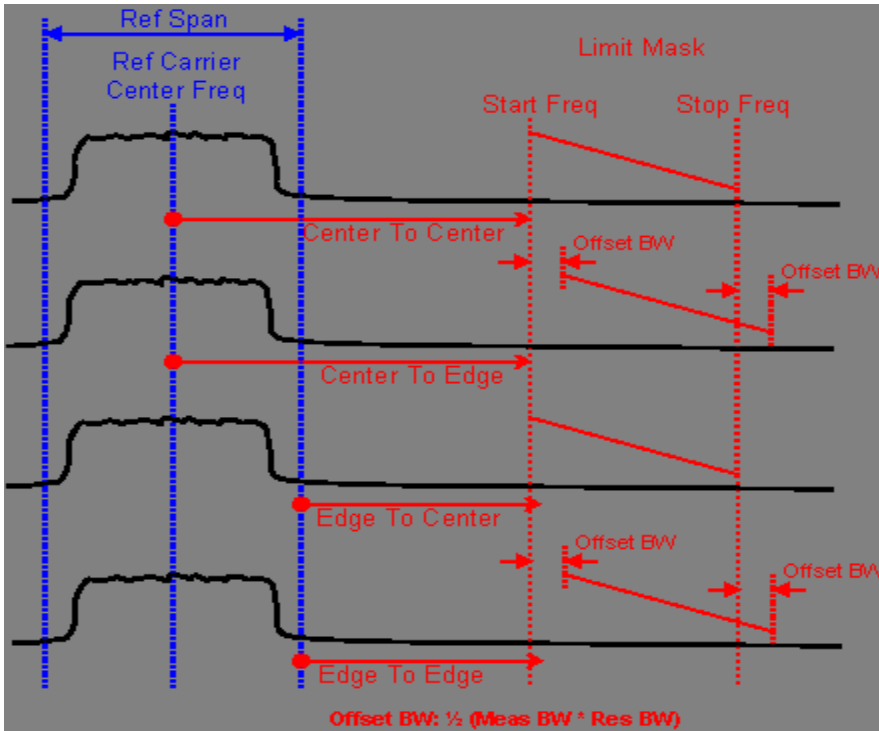
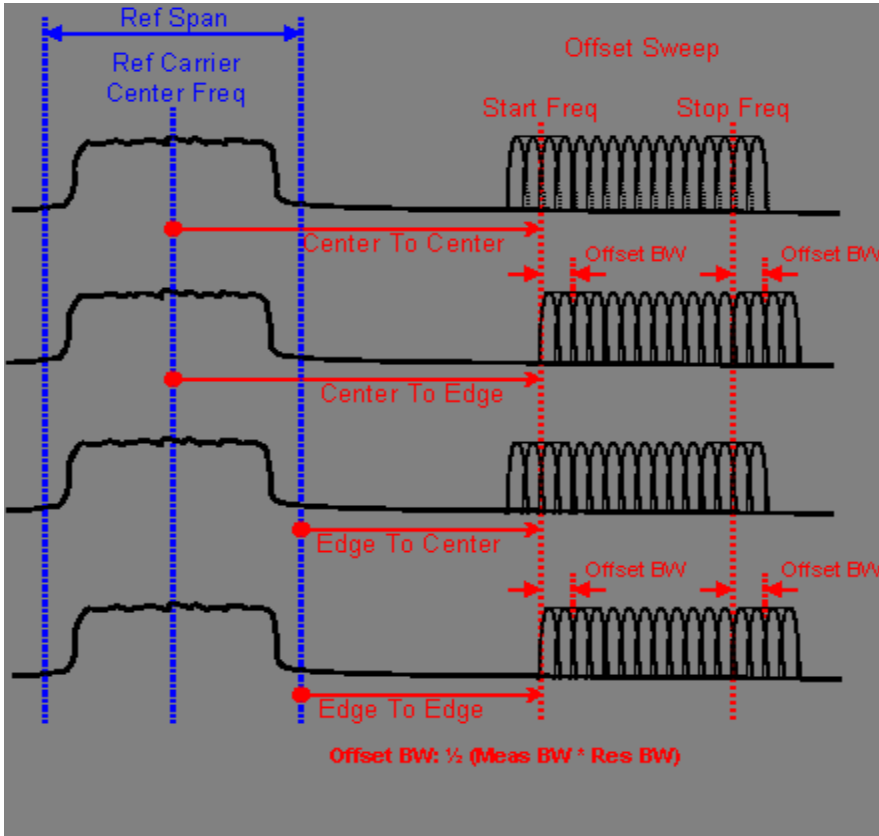

Key Path	Meas Setup, Offset/Limits
----------	---------------------------

Mode	SA, WCDMA, C2K, WIMAX OFDMA, TD-SCDMA, 1xEVDO, DVB-T/H, DTMB (CTTB), ISDB-T, CMMB, LTE, LTETDD
Remote Command	[:SENSE] :SEMAsk:OFFSet [1] 2 :TYPE CTOCenter CTOEdge ETOCenter ETOEdge [:SENSE] :SEMAsk:OFFSet [1] 2 :TYPE?
Example	SEM:OFFS:TYPE ETOC SEM:OFFS:TYPE?
Notes	You must be in the mode that includes SEM measurements to use this command. Use :INSTrument:SElect to set the mode.
Preset	SA, WCDMA, WIMAX OFDMA, TD-SCDMA, 1xEVDO, DVB-T/H, DTMB (CTTB), ISDB-T, CMMB: CTOC C2K: CTOE LTE: ETOC LTETDD: ETOC
State Saved	Saved in instrument state.
Range	Carrier Center To Meas BW Center Carrier Center To Meas BW Edge Carrier Edge To Meas BW Center Carrier Edge To Meas BW Edge
Initial S/W Revision	A.03.00

Mode

See “[Mode](#)” on page 1123 in the section "Common Measurement Functions" for more information.

Mode Setup

See “[Mode Setup](#)” on page 1141 in the section "Common Measurement Functions" for more information.

Peak Search

There is no 'Peak Search' supported in Spectrum Emission Mask so this front-panel key will display a blank key menu when pressed.

Key Path	Front-panel key
Initial S/W Revision	Prior to A.02.00

Recall

See [“Recall” on page 153](#) for more information.

State

See [“State” on page 153](#) for more information.

Data

See [“Data \(Import\)” on page 160](#) for more information.

Masks

See [“Mask” on page 163](#) for more information.

Restart

See “Restart” on page 1163 in the section "Common Measurement Functions" for more information.

Save

See [“Save” on page 170](#) in the section "Common Measurement Functions" for more information.

Single

See “[Single \(Single Measurement/Sweep\)](#)” on page 1169 in the section "Common Measurement Functions" for more information.

Source

See [“Source” on page 1171](#) in the section "Common Measurement Functions" for more information.

Span X Scale

Span X Scale functionality is not supported in Spectrum Emission Mask, so this front-panel key will display a blank key menu when pressed.

Key Path	Front-panel key
Initial S/W Revision	Prior to A.02.00

Sweep/Control

Displays a menu that enables you to set up and control the sweep time, gate method, and source of the current measurement. See [“Sweep/Control” on page 1181](#) in the "Common Measurement Functions" section for more information.

Key Path	Front-panel key
Initial S/W Revision	Prior to A.02.00

Pause

Pauses a measurement after the current data acquisition is complete. When Paused, the label on the key changes to Resume. Pressing the Resume key resumes the measurement at the point it was at when paused. See [“Pause/Resume” on page 1193](#) in “Common Measurement Functions” for more details.

Key Path	Sweep/Control
Initial S/W Revision	Prior to A.02.00

Gate

Accesses a menu that enables you to control the gating function .

The Gate functionality is used to view signals best viewed by qualifying them with other events. See [“Gate ” on page 1194](#) in “Common Measurement Functions” for more details.

Key Path	Sweep/Control
Initial S/W Revision	Prior to A.02.00

Trace/Detector

Accesses a menu of functions that enable you to control trace and detector for the current measurement.

Key Path	Front-panel key
Initial S/W Revision	Prior to A.02.00

Trace Type

Allows you to select the type of trace for the current measurement. The menu contains a 1-of-N selection of the trace type (Clear Write, Average, Max Hold, Min Hold).

Key Path	Trace/Detector
Mode	SA, WCDMA, C2K, WIMAX OFDMA, TD-SCDMA, 1xEVDO, DTMB (CTTB), DVB-T/H, ISDB-T, CMMB, LTE, LTETDD
Remote Command	:TRACe:SEMask:TYPE WRITe AVERAge MAXHold MINHold :TRACe:SEMask:TYPE?
Example	TRAC:SEM:TYPE MINH TRAC:SEM:TYPE?
Notes	WRITe = Clear Write AVERAge = Average MAXHold = Maximum Hold MINHold = Minimum Hold
Couplings	When Detector setting is “Auto” ([[:SENSe]:SEMask:DETECTOR:AUTO?]), Detector ([[:SENSe]:SEMask:DETECTOR[:FUNCTION]?]) switches aligning with the switch of this parameter: “NORMal” with WRITe (Clear Write), “AVERAge” with AVERAge, “POSitive (peak)” with MAXHold, and “NEGative (peak)” with MINHold.
Preset	AVERAge
State Saved	Saved in instrument state.
Range	WRITe AVERAge MAXHold MINHold
Initial S/W Revision	Prior to A.02.00
Modified at S/W Revision	A.02.00, A.03.00

Chan Detector

Accesses a menu of functions that enable you to control the detectors for reference channel. The following choices are available:

- Auto- the detector selected depends on marker functions, trace functions, average type, and the trace averaging function.
- Normal-the detector determines the peak of the CW-like signals, and it yields alternating maximums and minimums of noise-like signals. This is also referred to as Rosenfell detection.
- Average-the detector determines the average of the signal within the sweep points. The averaging method depends upon the Average Type selection (voltage, power or log scales).
- Peak-the detector determines the maximum of the signal within the sweep points.
- Sample-the detector indicates the instantaneous level of the signal at the center of the sweep points represented by each display point.
- Negative Peak-the detector determines the minimum of the signal within the sweep points.

Key Path	Trace/Detector
Initial S/W Revision	Prior to A.02.00

Chan Detector Selection

Selects the detector mode for the reference channel.

Key Path	Trace/Detector
Mode	SA, WCDMA, C2K, WIMAX OFDMA, TD-SCDMA, 1xEVDO, DTMB (CTTB), DVB-T/H, ISDB-T, CMMB, LTE, LTETDD
Remote Command	[:SENSE] :SEMAsk:DETEctor:CARRier[:FUNction] AVERAge NEGAtive NORMAl POSitive SAMPlE [:SENSE]:SEMAsk:DETEctor:CARRier[:FUNction]?
Example	SEM:DET:CARR NEG SEM:DET:CARR?
Notes	When you manually select a detector (instead of selecting Auto), that detector is used regardless of other analyzer settings. Note: This detector setting affects the reference channel. There is not a per trace detector. You must be in the Spectrum Analysis mode, W-CDMA mode, cdma2000 mode, TD-SCDMA mode, DTMB (CTTB) mode, DVB-T/H mode, ISDB-T mode, CMMB mode, LTE mode, LTE TDD mode, 1xEVDO mode or WIMAX OFDMA mode to use this command. Use :INSTRument:SELEct to set the mode.
Couplings	See Couplings in the Trace Type section.
Preset	AVERAge
State Saved	Saved in instrument state.
Range	Normal Average Peak Sample Negative Peak
Initial S/W Revision	Prior to A.02.00

Spectrum Emission Mask Measurement
Trace/Detector

Modified at S/W Revision	A.02.00, A.03.00
--------------------------	------------------

Chan Detector Auto

Sets the detector to the default detection mode for the reference channel. This mode is dependent upon the current reference channel conditions.

Key Path	Trace/Detector
Mode	SA, WCDMA, C2K, WIMAX OFDMA, TD-SCDMA, 1xEVDO, DTMB (CTTB), DVB-T/H, ISDB-T, CMMB, LTE, LTETDD
Remote Command	[:SENSE] :SEMAsk:DETector:CARRier:AUTO ON OFF 1 0 [:SENSE] :SEMAsk:DETector:CARRier:AUTO?
Example	SEM:DET:CARR:AUTO OFF SEM:DET:CARR:AUTO?
Notes	See Couplings in the Trace Type section. You must be in the Spectrum Analysis mode, W-CDMA mode, cdma2000 mode, TD-SCDMA mode, DTMB (CTTB) mode, DVB-T/H mode, ISDB-T mode, CMMB mode, LTE mode, LTE TDD mode 1xEVDO mode or WIMAX OFDMA mode to use this command. Use INSTRument:SElect to set the mode.
Preset	ON
State Saved	Saved in instrument state.
Range	On Off
Initial S/W Revision	Prior to A.02.00
Modified at S/W Revision	A.02.00, A.03.00

Offset Detector

Accesses a menu of functions that enable you to control the detector for offsets. The following choices are available.

- Auto- the detector selected depends on marker functions, trace functions, average type, and the trace averaging function.
- Normal-the detector determines the peak of the CW-like signals, and it yields alternating maximums and minimums of noise-like signals. This is also referred to as Rosenfell detection.
- Average-the detector determines the average of the signal within the sweep points. The averaging method depends upon the Average Type selection (voltage, power or log scales).
- Peak-the detector determines the maximum of the signal within the sweep points.
- Sample-the detector indicates the instantaneous level of the signal at the center of the sweep points represented by each display point.

- Negative Peak-the detector determines the minimum of the signal within the sweep points.

Key Path	Trace/Detector
Initial S/W Revision	Prior to A.02.00

Offset Detector Selection

Selects the detector mode for the offsets.

Key Path	Trace/Detector
Mode	SA, WCDMA, C2K, WIMAX OFDMA, TD-SCDMA, 1xEVDO, DTMB (CTTB), DVB-T/H, ISDB-T, CMMB, LTE, LTETDD
Remote Command	[:SENSE] :SEMAsk:DETEctor:OFFSet [:FUNction] AVERAge NEGAtive NORMAl POSitive SAMPLe [:SENSE] :SEMAsk:DETEctor:OFFSet [:FUNction] ?
Example	SEM:DET:OFFS AVER SEM:DET:OFFS?
Notes	When you manually select a detector (instead of selecting Auto), that detector is used regardless of other analyzer settings. Note: This detector setting has effects all offsets. There is not a per trace detector. You must be in the Spectrum Analysis mode, W-CDMA mode, cdma2000 mode, TD-SCDMA mode, DTMB (CTTB) mode, DVB-T/H mode, ISDB-T mode, CMMB mode, LTE mode, LTE TDD mode 1xEVDO mode or WIMAX OFDMA mode to use this command. Use :INSTrument:SELEct to set the mode.
Couplings	See Couplings in the Trace Type section.
Preset	SA, WCDMA, C2K, 1xEVDO, DTMB (CTTB), DVB-T/H, LTE, LTETDD: POSitive WIMAX OFDMA, TD-SCDMA ISDB-T, CMMB: POSitive
State Saved	Saved in instrument state.
Range	Normal Average Peak Sample Negative Peak
Initial S/W Revision	Prior to A.02.00
Modified at S/W Revision	A.02.00, A.03.00

Offset Detector Auto

Sets the detector to the default detection mode for the offsets. This mode is dependent upon the current

Spectrum Emission Mask Measurement
Trace/Detector

signal conditions of the offsets.

Key Path	Trace/Detector
Mode	SA, WCDMA, C2K, WIMAX OFDMA, TD-SCDMA, 1xEVDO, DTMB (CTTB), DVB-T/H, ISDB-T, CMMB, LTE, LTETDD
Remote Command	[:SENSE] :SEMAsk:DETEctor:OFFSet:AUTO ON OFF 1 0 [:SENSE] :SEMAsk:DETEctor:OFFSet:AUTO?
Example	SEM:DET:OFFS:AUTO OFF SEM:DET:OFFS:AUTO?
Notes	See Couplings in the Trace Type section. You must be in the Spectrum Analysis mode, W-CDMA mode, cdma2000 mode, TD-SCDMA mode, DTMB (CTTB) mode, DVB-T/H mode, ISDB-T mode, CMMB mode, LTE mode, LTE TDD mode, 1xEVDO mode or WIMAX OFDMA mode to use this command. Use :INSTrument:SELEct to set the mode.
Preset	ON
State Saved	Saved in instrument state.
Range	On Off
Initial S/W Revision	Prior to A.02.00
Modified at S/W Revision	A.02.00, A.03.00

Trigger

Accesses a menu that enables you to select and control the trigger source for the current measurement.
See [“Trigger” on page 1251](#) in the "Common Measurement Functions" section for more information.

View/Display

Accesses a menu of functions that enable you to control the instrument display.

The following keys select how the results are displayed:

Abs Pwr Freq-displays the absolute power levels in dBm and the corresponding frequencies in the text window.

Rel Pwr Freq-displays the relative power levels in dBc and the corresponding frequencies in the text window.

Integrated Power-displays the absolute and relative power levels integrated throughout the bandwidths between the start and stop frequencies in the text window.

[“View Selection by Name \(Remote Command only\)” on page 613](#)

[“Views Selection by Number \(Remote Command only\)” on page 613](#)

View Selection by Name (Remote Command only)

Key Path	View/Display
Mode	SA, WCDMA, C2K, WIMAX OFDMA, TD-SCDMA, 1xEVDO, DTMB (CTTB), DVB-T/H, ISDB-T, CMMB, LTE, LTETDD
Remote Command	:DISPlay:SEMask:VIEW[:SElect] APFReq RPFRReq IPOwer :DISPlay:SEMask:VIEW[:SElect]?
Example	DISP:SEM:VIEW IPOW DISP:SEM:VIEW?
Notes	You must be in the Spectrum Analysis mode, W-CDMA mode, cdma2000 mode, TD-SCDMA mode, DTMB (CTTB) mode, DVB-T/H mode, ISDB-T mode, CMMB mode, LTE mode, LTE TDD mode, 1xEVDO mode or WIMAX OFDMA mode to use this command. Use :INSTrument:SElect to set the mode.
Dependencies	In the SA mode, when "Radio Standard" is set to WLAN, IPOwer is not available and the key is grayed out.
Preset	SA, WCDMA, C2K, TD-SCDMA, 1xEVDO, DTMB (CTTB), DVB-T/H, ISDB-T, CMMB, LTE, LTETDD: APFReq WIMAX OFDMA: RPFRReq
State Saved	Saved in instrument state.
Range	Abs Pwr & Freq Rel Pwr & Freq Integrated Power
Initial S/W Revision	Prior to A.02.00
Modified at S/W Revision	A.02.00, A.03.00

Views Selection by Number (Remote Command only)

The following numerical selections select how the results are displayed:

1. displays the absolute power levels in dBm and the corresponding frequencies in the text window.
2. displays the relative power levels in dBc and the corresponding frequencies in the text window.
3. displays the absolute and relative power levels integrated throughout the bandwidths between the start and stop frequencies in the text window.

Mode	SA, WCDMA, C2K, WIMAX OFDMA, TD-SCDMA, 1xEVDO, DTMB (CTTB), DVB-T/H, ISDB-T, CMMB, LTE, LTETDD
Remote Command	:DISPlay:SEMask:VIEW:NSElect <integer> :DISPlay:SEMask:VIEW:NSElect?
Example	DISP:SEM:VIEW:NSEL 2 DISP:SEM:VIEW:NSEL?

Spectrum Emission Mask Measurement
View/Display

Notes	In the SA mode, when "Radio Standard" is set to WLAN, 3 is not available. You must be in the Spectrum Analysis mode, W-CDMA mode, cdma2000 mode, TD-SCDMA mode, DTMB (CTTB) mode, DVB-T/H mode, ISDB-T mode, CMMB mode, LTE mode, LTE TDD mode, 1xEVDO mode or WIMAX OFDMA mode to use this command. Use :INSTrument:SElect to set the mode.
Preset	SA, WCDMA, C2K, TD-SCDMA, 1xEVDO, DTMB (CTTB), DVB-T/H, ISDB-T, CMMB, LTE, LTETDD: 1 WIMAX OFDMA: 2
State Saved	Saved in instrument state.
Min	1
Max	3
Initial S/W Revision	Prior to A.02.00
Modified at S/W Revision	A.02.00, A.03.00

Key Path	Front-panel key
Initial S/W Revision	Prior to A.02.00

Display

Accesses a menu of functions that enable you to set the display parameters.

See [“Display” on page 1313](#) in the "Common Measurement Functions" section for more information.

Key Path	View/Display
Initial S/W Revision	Prior to A.02.00

Abs Pwr Freq

Abs Peak Pwr & Freq (Total Pwr Ref)

This view consists of the following two windows:

[“Trace Window” on page 615](#)

[“Results Window” on page 615](#)

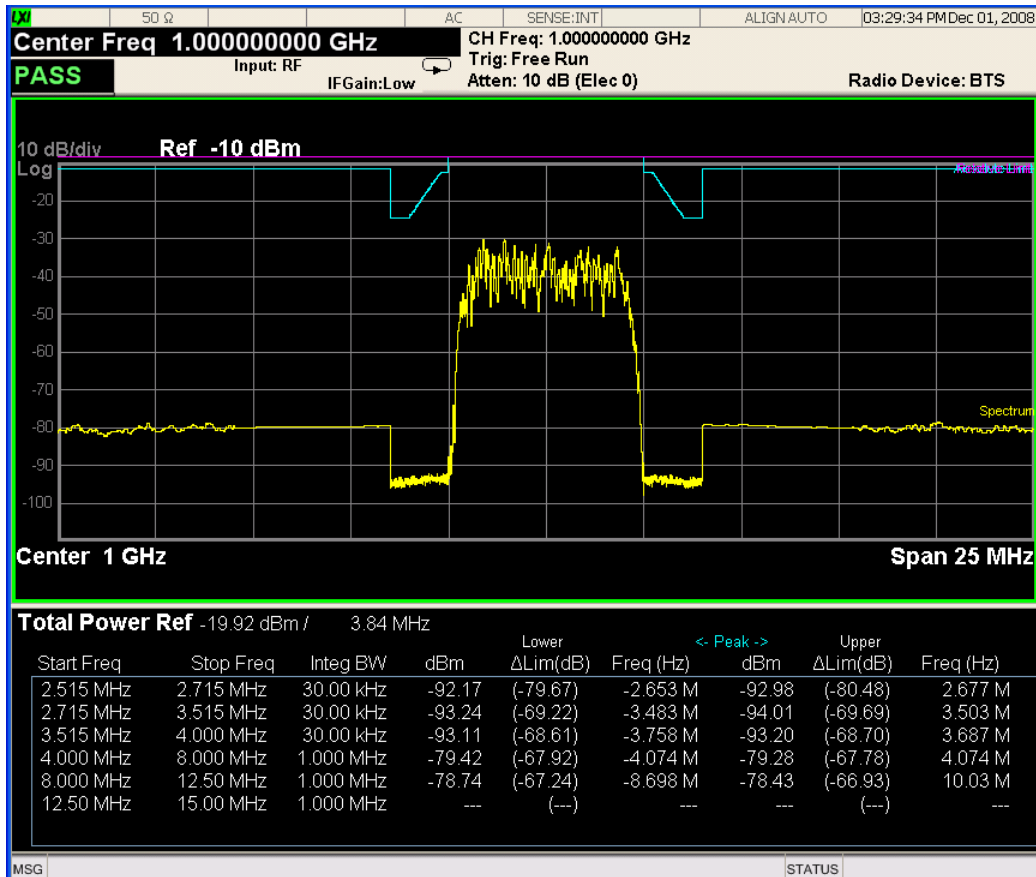

Trace Window

Corresponding Trace	yellow - Combined trace from carrier and each offset
---------------------	--

Results Window

Name	Corresponding Results
Total Pwr Ref	n=1 2nd element Absolute power at the reference area.
	Channel Integration Bandwidth
Start(Hz)	Start frequency for offset
Stop(Hz)	Stop frequency for offset
Meas BW(Hz)	Measurement bandwidth for offset
Lower Peak(dBm)	Absolute peak power on minimum margin point of the negative offset

Spectrum Emission Mask Measurement
View/Display

Name	Corresponding Results
Lower Lim(dB)	Minimum margin from limit line which is decided by Fail Mask setting on the negative offset
Lower Freq(Hz)	Frequency on minimum margin point of the negative offset
Upper Peak(dBm)	Absolute peak power on minimum margin point of the positive offset
Upper Lim(dB)	Minimum margin from limit line which is decided by Fail Mask setting on the positive offset
Upper Freq(Hz)	Frequency on minimum margin point of the positive offset

Abs Peak Pwr & Freq (PSD Ref)

This view consists of the following two windows:

“Trace Window” on page 617

“Results Window” on page 617

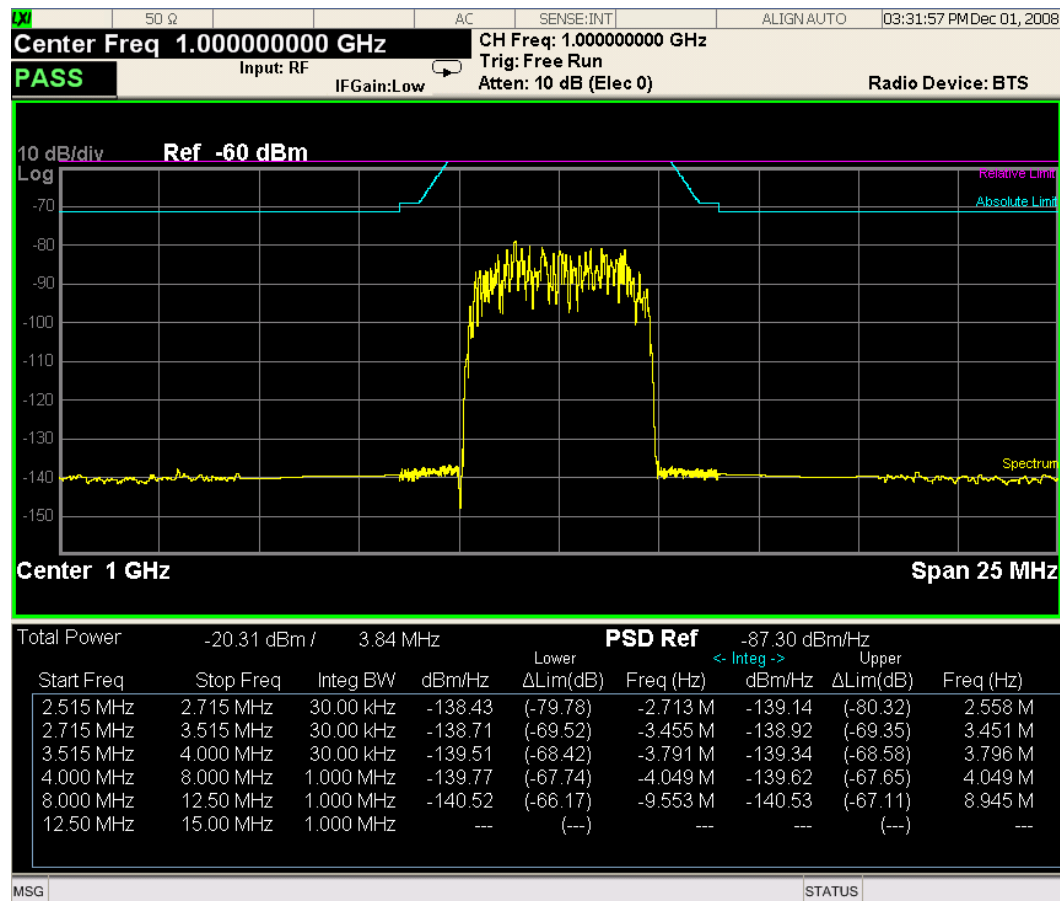

Trace Window

Corresponding Trace	yellow - Combined trace from carrier and each offset
---------------------	--

Results Window

Name	Corresponding Results
Total Pwr	n=1 2nd element Absolute power at the reference area.
	Channel Integration Bandwidth
PSD Ref	n=5 1st element Power spectral density reference at the reference area
Start(Hz)	Start frequency for offset
Stop(Hz)	Stop frequency for offset
Meas BW(Hz)	Measurement bandwidth for offset
Lower(dBm/Hz)	Absolute power spectrum density of the negative offset
Lower Lim(dB)	Minimum margin from limit line which is decided by Fail Mask setting on the negative offset
Lower Freq(Hz)	Frequency on minimum margin point of the negative offset
Upper(dBm/Hz)	Absolute power spectrum density of the positive offset
Upper Lim(dB)	Minimum margin from limit line which is decided by Fail Mask setting on the positive offset
Upper Freq(Hz)	Frequency on minimum margin point of the positive offset

Abs Peak Pwr & Freq (Spectrum Pk Ref)

This view consists of the following two windows:

[“Trace Window” on page 617](#)

[“Results Window” on page 617](#)

Spectrum Emission Mask Measurement View/Display

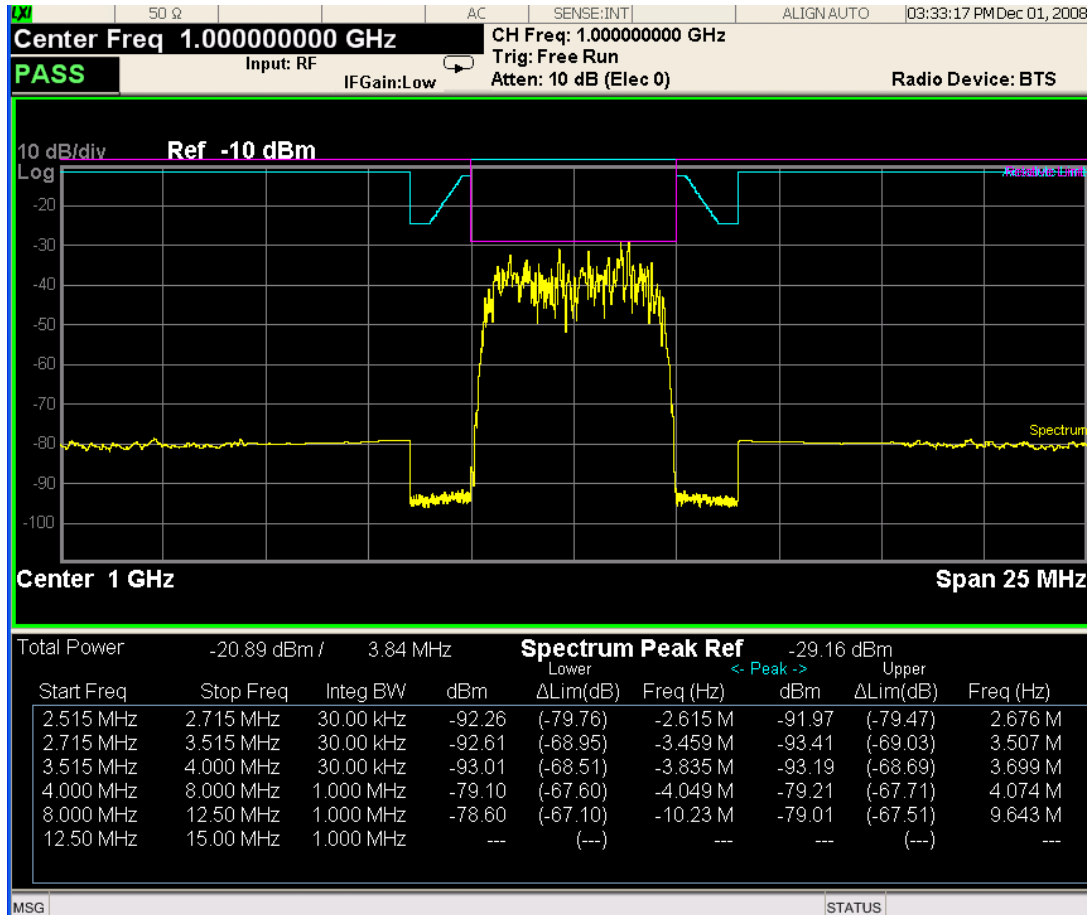

Trace Window

Corresponding Trace	yellow - Combined trace from carrier and each offset
---------------------	--

Results Window

Name	Corresponding Results
Total Pwr	Absolute power at the reference area.
	Channel Integration Bandwidth
Spectrum Peak Ref	n=5 1st element Spectrum peak power reference at the reference area
Start(Hz)	Start frequency for offset
Stop(Hz)	Stop frequency for offset
Meas BW(Hz)	Measurement bandwidth for offset
Lower(dBm)	Absolute peak power on minimum margin point of the negative offset

Name	Corresponding Results
Lower Lim(dB)	Minimum margin from limit line which is decided by Fail Mask setting on the negative offset
Lower Freq(Hz)	Frequency on minimum margin point of the negative offset
Upper(dBm)	Absolute peak power on minimum margin point of the positive offset
Upper Lim(dB)	Minimum margin from limit line which is decided by Fail Mask setting on the positive offset
Upper Freq(Hz)	Frequency on minimum margin point of the positive offset

Key Path	View/Display
Initial S/W Revision	Prior to A.02.00

Rel Pwr Freq

Rel Peak Pwr & Freq (Total Pwr Ref)

This view consists of the following two windows:

[“Trace Window” on page 620](#)

[“Results Window” on page 620](#)

Spectrum Emission Mask Measurement
View/Display

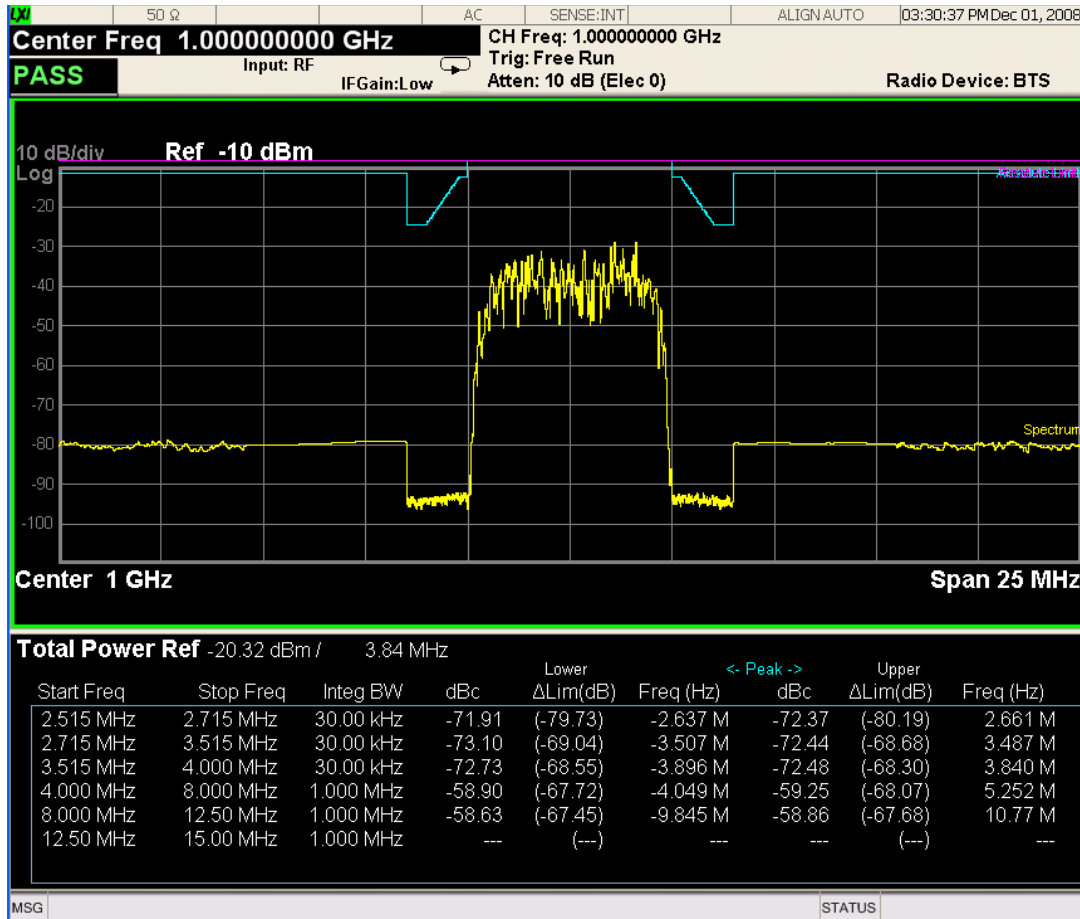

Trace Window

Corresponding Trace	yellow - Combined trace from carrier and each offset
---------------------	--

Results Window

Name	Corresponding Results
Total Pwr Ref	n=1 2nd element Absolute power at the reference area.
	Channel Integration Bandwidth
Start(Hz)	Start frequency for offset
Stop(Hz)	Stop frequency for offset
Meas BW(Hz)	Measurement bandwidth for offset
Lower Peak(dBc)	Relative peak power on minimum margin point of the negative offset

Name	Corresponding Results
Lower Lim(dB)	Minimum margin from limit line which is decided by Fail Mask setting on the negative offset
Lower Freq(Hz)	Frequency on minimum margin point of the negative offset
Upper Peak(dBc)	Relative peak power on minimum margin point of the positive offset
Upper Lim(dB)	Minimum margin from limit line which is decided by Fail Mask setting on the positive offset
Upper Freq(Hz)	Frequency on minimum margin point of the positive offset

Rel Peak Pwr & Freq (PSD Ref)

This view consists of the following two windows:

“Trace Window” on page 622

“Results Window” on page 622

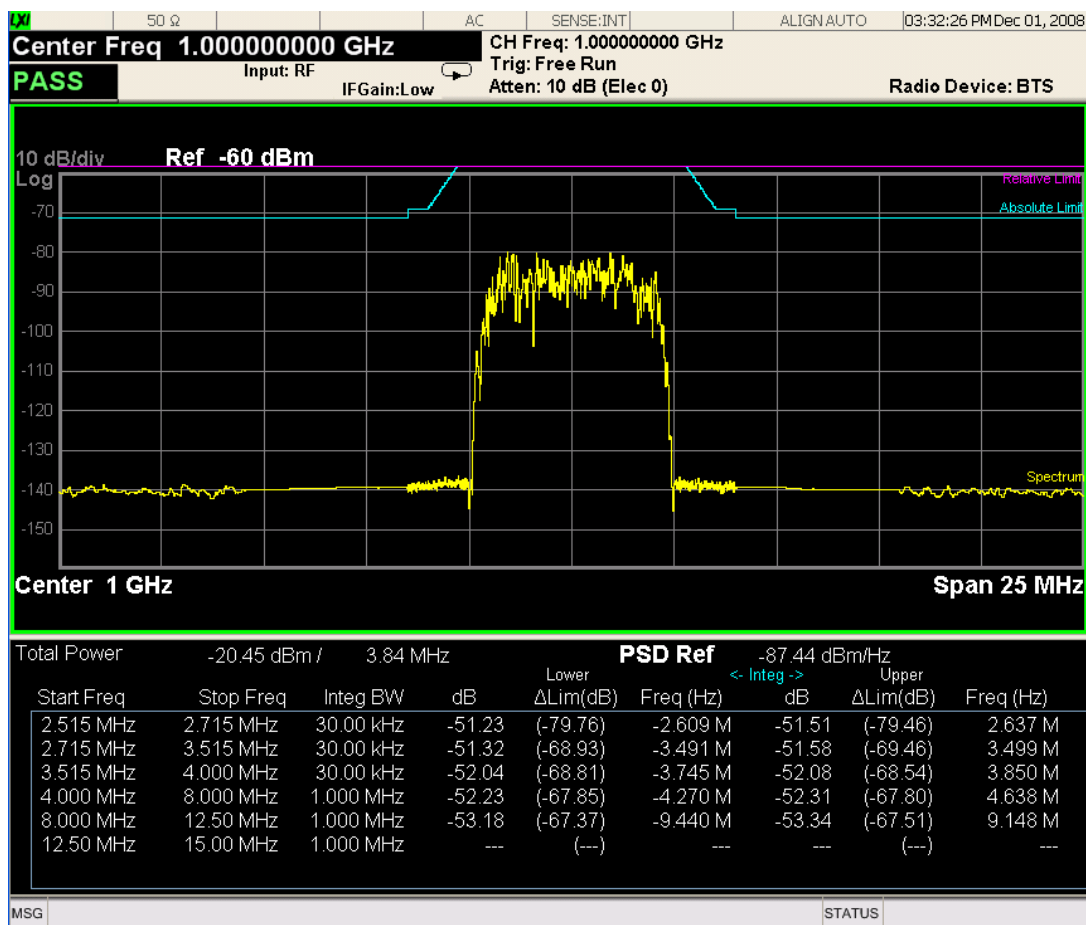

Trace Window

Corresponding Trace	yellow - Combined trace from carrier and each offset
---------------------	--

Results Window

Name	Corresponding Results
Total Pwr	n=1 2nd element Absolute power at the reference area.
	Channel Integration Bandwidth
PSD Ref	n=5 1st element Power spectral density reference at the reference area
Start(Hz)	Start frequency for offset
Stop(Hz)	Stop frequency for offset
Meas BW(Hz)	Measurement bandwidth for offset
Lower(dB)	Relative power spectrum density of the negative offset
Lower Lim(dB)	Minimum margin from limit line which is decided by Fail Mask setting on the negative offset
Lower Freq(Hz)	Frequency on minimum margin point of the negative offset
Upper(dB)	Relative power spectrum density of the positive offset
Upper Lim(dB)	Minimum margin from limit line which is decided by Fail Mask setting on the positive offset
Upper Freq(Hz)	Frequency on minimum margin point of the positive offset

Rel Peak Pwr & Freq (Spectrum Pk Ref)

This view consists of the following two windows:

“Trace Window” on page 620

“Results Window” on page 620

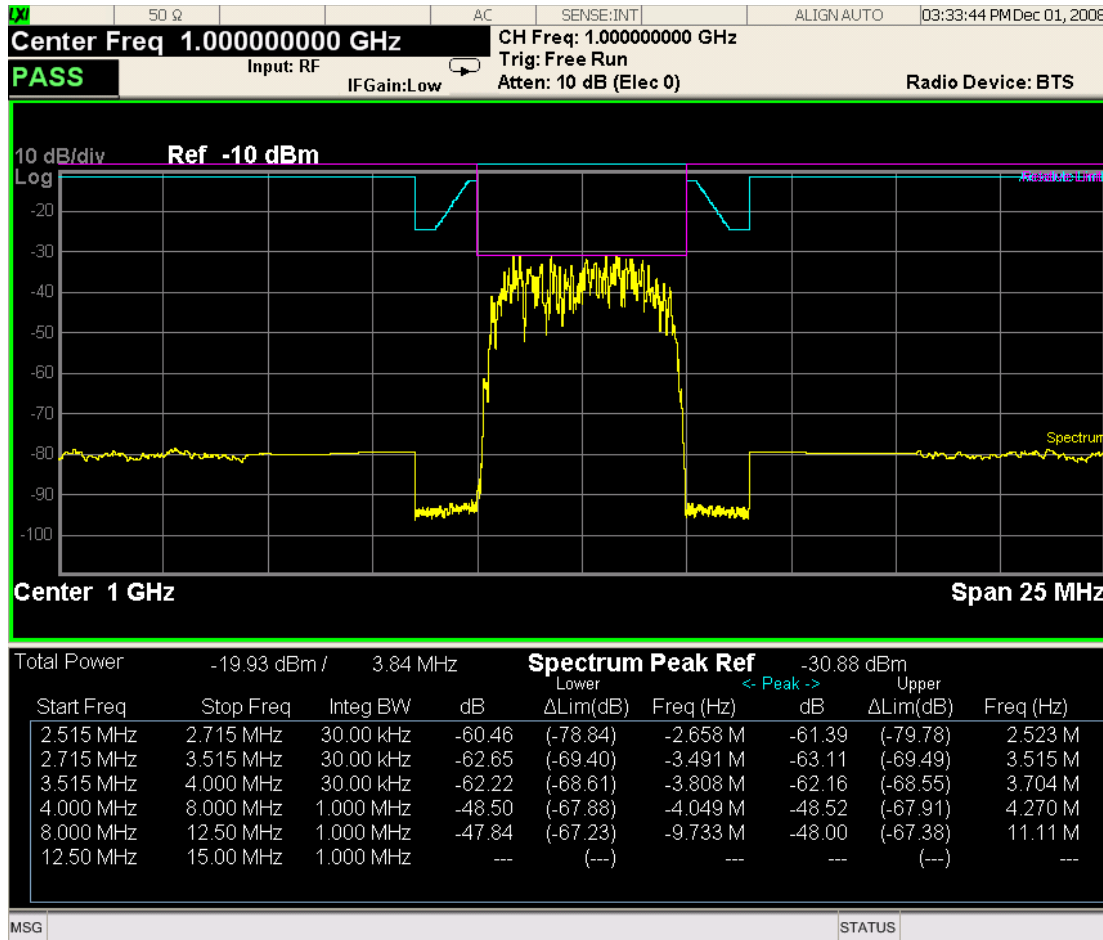

Trace Window

Corresponding Trace	yellow - Combined trace from carrier and each offset
---------------------	--

Results Window

Name	Corresponding Results
Total Pwr	Absolute power at the reference area.
	Channel Integration Bandwidth
Spectrum Peak Ref	n=5 1st element Spectrum peak power reference at the reference area
Start(Hz)	Start frequency for offset
Stop(Hz)	Stop frequency for offset
Meas BW(Hz)	Measurement bandwidth for offset

Spectrum Emission Mask Measurement
View/Display

Name	Corresponding Results
Lower Peak(dB)	Relative peak power on minimum margin point of the negative offset
Lower Lim(dB)	Minimum margin from limit line which is decided by Fail Mask setting on the negative offset
Lower Freq(Hz)	Frequency on minimum margin point of the negative offset
Upper Peak(dB)	Relative peak power on minimum margin point of the positive offset
Upper Lim(dB)	Minimum margin from limit line which is decided by Fail Mask setting on the positive offset
Upper Freq(Hz)	Frequency on minimum margin point of the positive offset

Key Path	View/Display
Initial S/W Revision	Prior to A.02.00

Integrated Power

Integrated Power (Total Pwr Ref)

[“Trace Window” on page 625](#)

[“Results Window” on page 625](#)

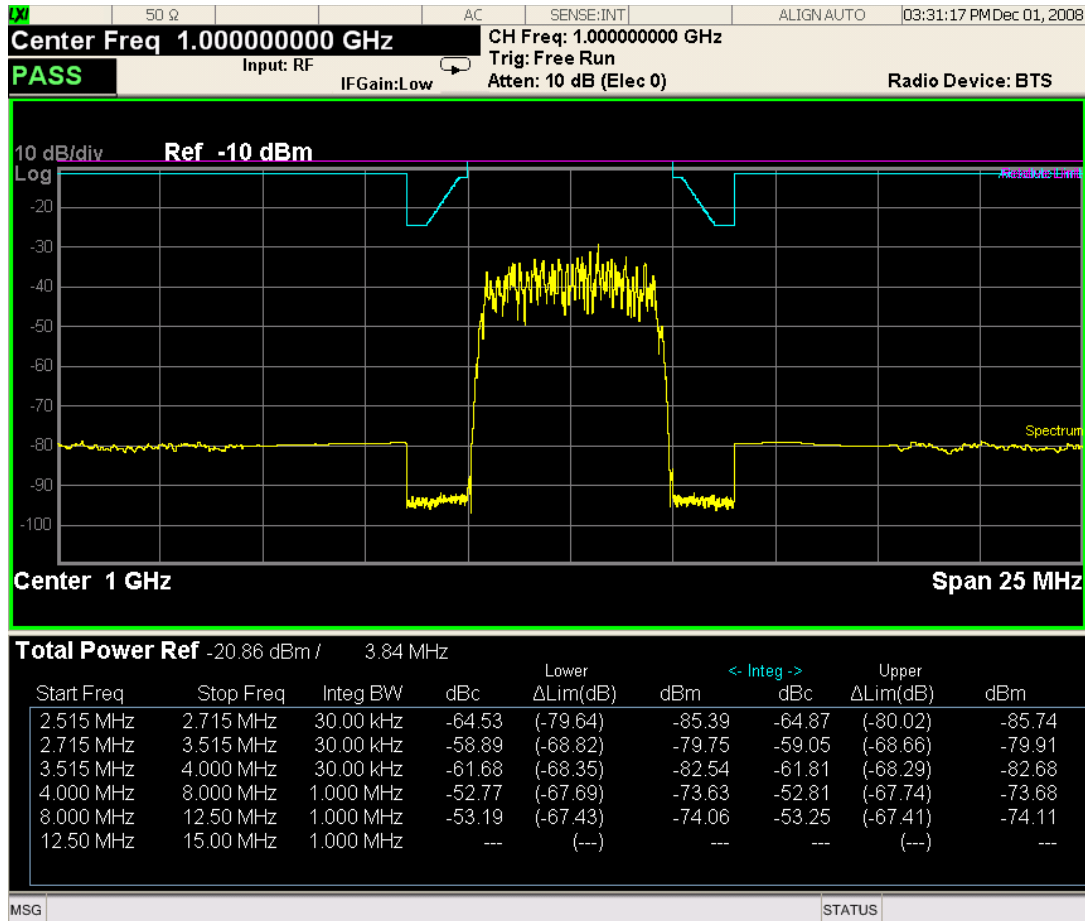

Trace Window

Corresponding Trace	yellow - Combined trace from carrier and each offset
---------------------	--

Results Window

Name	Corresponding Results
Total Pwr Ref	n=1 2nd element Absolute power at the reference area.
	Channel Integration Bandwidth
Start(Hz)	Start frequency for offset
Stop(Hz)	Stop frequency for offset
Meas BW(Hz)	Measurement bandwidth for offset
Lower Integ(dBc)	Relative integrated power on the negative offset
Lower Lim(dB)	Minimum margin from limit line which is decided by Fail Mask setting on the negative offset

Spectrum Emission Mask Measurement
View/Display

Name	Corresponding Results
Lower Integ(dBm)	Absolute integrated power on the negative offset
Upper Integ(dBc)	Relative integrated power on the positive offset
Upper Lim(dB)	Minimum margin from limit line which is decided by Fail Mask setting on the positive offset
Upper Integ(dBm)	Absolute integrated power on the positive offset

Integrated Power (PSD Ref)

“Trace Window” on page 626

“Results Window” on page 627

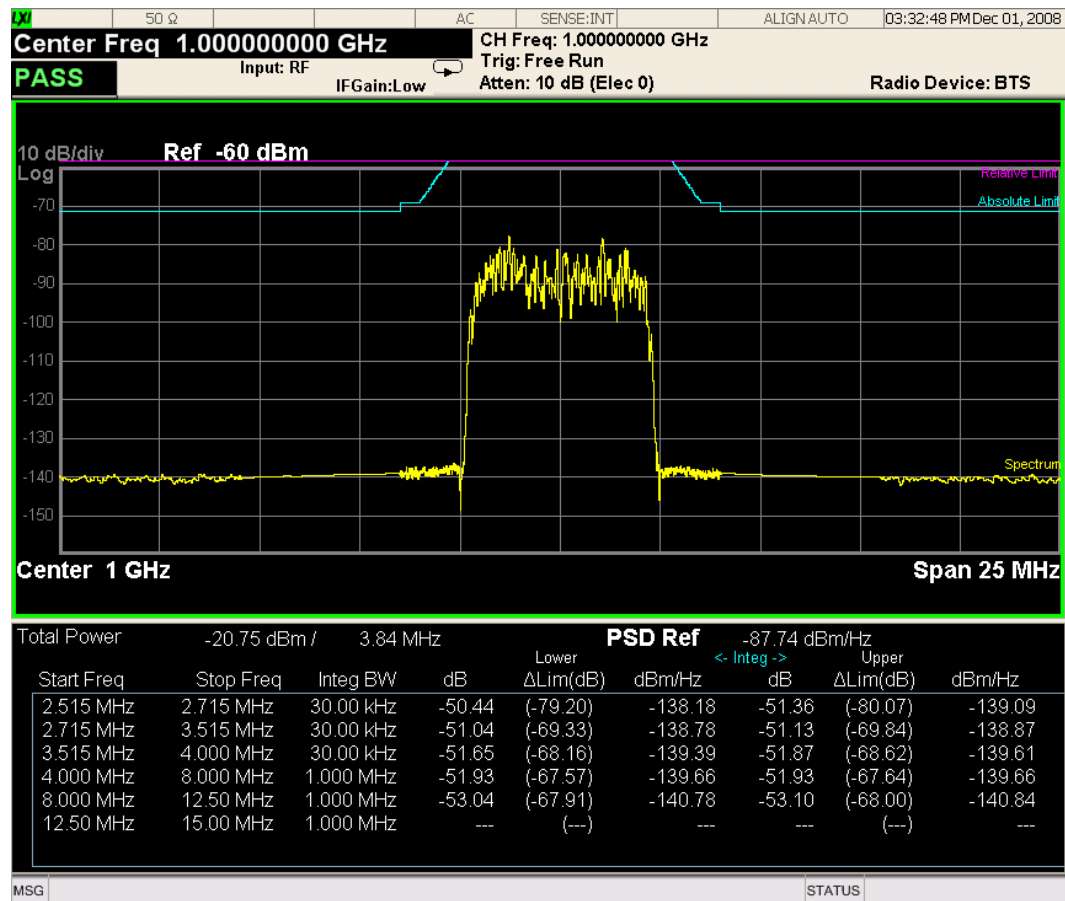

Trace Window

Corresponding Trace	yellow - Combined trace from carrier and each offset
---------------------	--

Results Window

Name	Corresponding Results
Total Pwr	n=1 2nd element Absolute power at the reference area.
	Channel Integration Bandwidth
PSD Ref	n=5 1st element Power spectral density reference at the reference area
Start(Hz)	Start frequency for offset
Stop(Hz)	Stop frequency for offset
Meas BW(Hz)	Measurement bandwidth for offset
Lower(dB)	Relative power spectrum density of the negative offset
Lower Lim(dB)	Minimum margin from limit line which is decided by Fail Mask setting on the negative offset
Lower(dBm/Hz)	Absolute power spectrum density of the negative offset
Upper(dB)	Relative power spectrum density of the positive offset
Upper Lim(dB)	Minimum margin from limit line which is decided by Fail Mask setting on the positive offset
Upper(dBm/Hz)	Absolute power spectrum density of the negative offset

Integrated Power (Spectrum Pk Ref)

[“Trace Window” on page 628](#)

[“Results Window” on page 628](#)

Spectrum Emission Mask Measurement
View/Display

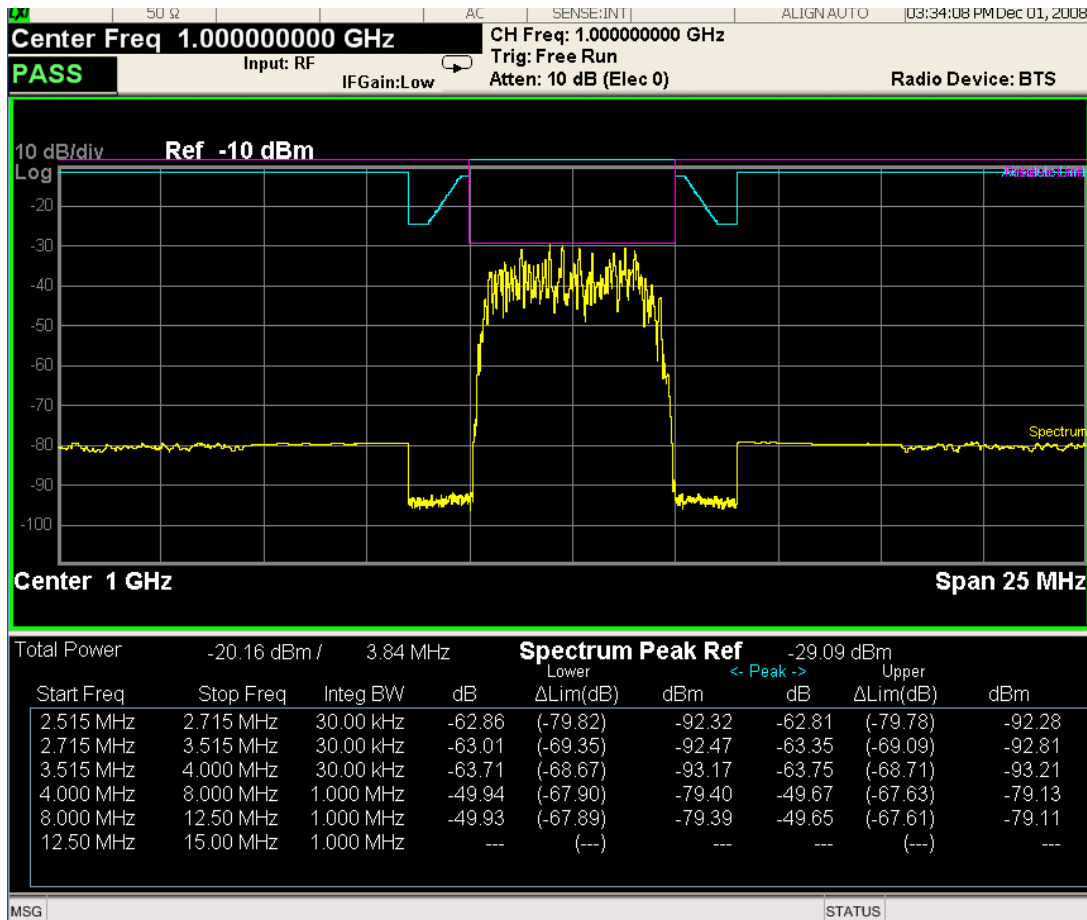

Trace Window

Corresponding Trace	yellow - Combined trace from carrier and each offset
---------------------	--

Results Window

Name	Corresponding Results
Total Pwr	Absolute power at the reference area.
	Channel Integration Bandwidth
Spectrum Peak Ref	n=5 1st element Peak power at the reference area
Start(Hz)	Start frequency for offset
Stop(Hz)	Stop frequency for offset
Meas BW(Hz)	Measurement bandwidth for offset
Lower Peak(dB)	Relative peak power on minimum margin point of the negative offset

Name	Corresponding Results
Lower lim(dB)	Minimum margin from limit line which is decided by Fail Mask setting on the negative offset
Lower Peak(dBm)	Absolute peak power on minimum margin point of the negative offset
Upper Peak(dB)	Relative peak power on minimum margin point of the positive offset
Upper lim(dB)	Minimum margin from limit line which is decided by Fail Mask setting on the positive offset
Upper Peak(dBm)	Absolute peak power on minimum margin point of the positive offset

Key Path	View/Display
Initial S/W Revision	Prior to A.02.00

Limit Lines

Toggles the limit lines display function for the spectrum emission mask measurements On and Off.

Key Path	View/Display
Mode	SA, WCDMA, C2K, WIMAX OFDMA, TD-SCDMA, 1xEVDO, DTMB (CTTB), DVB-T/H, ISDB-T, CMMB, LTE, LTETDD
Remote Command	:CALCulate:SEMask:LLINe:STATe ON OFF 1 0 :CALCulate:SEMask:LLINe:STATe?
Example	CALC:SEM:LLIN:STAT OFF CALC:SEM:LLIN:STAT?
Notes	You must be in the Spectrum Analysis mode, W-CDMA mode, cdma2000 mode, TD-SCDMA mode, DTMB (CTTB) mode, DVB-T/H mode, ISDB-T mode, CMMB mode, LTE mode, LTE TDD mode 1xEVDO mode or WIMAX OFDMA mode to use this command. Use :INSTrument:SElect to set the mode.
Preset	ON
State Saved	Saved in instrument state.
Range	On Off
Initial S/W Revision	Prior to A.02.00
Modified at S/W Revision	A.02.00, A.03.00

Spectrum Emission Mask Measurement
View/Display

The Modulation Accuracy measurement is used to measure the modulation accuracy of CMMB signal. Various parameters that measure the quality of modulation are reported. For more details, see [“Mod Accuracy Measurement Description”](#) on page 634 below.

This topic contains the following sections:

[“Measurement Commands for Mod Accuracy”](#) on page 631

[“Remote Command Results for Mod Accuracy Measurement”](#) on page 631

Measurement Commands for Mod Accuracy

The general functionality of CONFigure, FETCh, INITiate, MEASure, and READ are described at this section.

CONFigure:EVM

CONFigure:EVM:NDEFault

FETCh:EVM[n] ?

INITiate:EVM

MEASure:EVM[n] ?

READ:EVM[n] ?

For more measurement related commands, see the SENSE subsystem, and the section [“Remote Measurement Functions”](#) on page 1083.

Remote Command Results for Mod Accuracy Measurement

For each result, the following heading is used to represent its format and precision.

#.Result Name (type of number) [unit] <explanation>

Type of number includes double, float and integer.

Index: n <Mnemonic>	Results Returned
0	<p>I/Q Capture Data Trace (float) [volt] <2 * duration of an OFDM symbol * sample rate * num of demodulated symbols></p> <p>Returns unprocessed I/Q trace data of Capture Interval, as a series of trace point values, in volts. The I values are listed first in each pair, using the 0 through even-indexed values. The Q values are the odd-indexed values.</p> <p>The sample rate is 15 MHz in this measurement.</p> <p>If no data is captured, one NaN will be returned.</p>

Index: n <Mnemonic>	Results Returned
1 (or not specified)	<p>Returns 31 comma-separated scalar results, in the following order:</p> <ol style="list-style-type: none"> 1. EVM (Average) (double) [%] Averaged EVM in an average cycle. The EVM to be averaged is calculated using all the carriers in the current symbols. 2. Peak EVM (double) [% pk] Peak EVM value in the current symbols. 3. Position of Peak EVM - Sub-carrier Number (int) [NA] Sub-carrier number corresponding to the position of peak EVM is returned. 4. MER (Average) (double) [dB] Averaged MER in an average cycle. The MER to be averaged is calculated using all the carriers in the current symbols. 5. Peak MER (double) [dB pk] Peak MER value in the current symbols. 6. Position of Peak MER - Sub-carrier Number (int) [NA] Sub-carrier number corresponding to the position of peak MER is returned. 7. Mag Error (Average) (double) [%] Averaged magnitude error in an average cycle. The magnitude error to be averaged is calculated using all the carriers in the current symbols. 8. Peak Mag Error (double) [% pk] Peak magnitude error in the current symbols. 9. Position of Peak Mag Error - Sub-carrier Number (int) [NA] Sub-carrier number corresponding to the position of peak magnitude error is returned. 10. Phase Error (Average) (double) [deg] Averaged phase error in an average cycle. The phase error to be averaged is calculated using all the carriers in the current symbols. 11. Peak Phase Error (double) [deg pk] Peak phase error in the current symbols. 12. Position of Peak Phase Error - Sub-carrier Number (int) [NA] Sub-carrier number corresponding to the position of peak phase error is returned. 13. Freq Err (Average) (double) [Hz] Averaged (in average cycle) frequency error of the current symbols. 14. Amptd Imbalance (Average) (double) [dB] Averaged (in average cycle) amplitude imbalance of I and Q signal in dB. 15. Quad Err (Average) (double) [deg]

Index: n <Mnemonic>	Results Returned
1 (or not specified) (Continued)	<p>Averaged (in average cycle) quadrature error of the current symbols.</p> <p>16. Timing Skew (Average) (double) [us] Averaged (in average cycle) timing skew of the current symbols.</p> <p>17. Max to CF (double) [dB] The difference between Max Amplitude Inband and Amplitude at Center Frequency point.</p> <p>18. Position of Max Amplitude Inband - Sub-carrier Number (int) [NA] Sub-carrier number corresponding to the position of Max Amplitude Inband is returned.</p> <p>19. Min to CF (double) [dB] The difference between Min Amplitude Inband and Amplitude at Center Frequency point.</p> <p>20. Position of Min Amplitude Inband - Sub-carrier Number (int) [NA] Sub-carrier number corresponding to the position of Min Amplitude Inband is returned.</p> <p>21. Data EVM (Average) (double) [%] Averaged (in average cycle) EVM of data carriers.</p> <p>22. Cont Pilot EVM (Average) (double) [%] Averaged (in average cycle) EVM of continued pilot carriers.</p> <p>23. Scat Pilot EVM (Average) (double) [%] Averaged (in average cycle) EVM of scattered pilot carriers.</p> <p>24. Data MER (Average) (double) [dB] Averaged (in average cycle) MER of data carriers.</p> <p>25. Cont Pilot MER (Average) (double) [dB] Averaged (in average cycle) MER of continued pilot carriers.</p> <p>26. Scat Pilot MER (Average) (double) [dB] Averaged (in average cycle) MER of scattered pilot carriers.</p> <p>27. Trigger Difference (Average) (double) [us] Averaged (in average cycle) Trigger Difference of the current symbols.</p> <p>28. Region Index (int) [NA] Region Index of the current signal.</p> <p>29. Transmitter Index (int) [NA] Transmitter Index of the current signal.</p> <p>30. Current Slot (int) [NA] This result is only available in 'Free Run' mode (Trigger, Free Run). In 'Free Run' mode, it is the currently detected time slot index in a measurement cycle. Otherwise, it will be -999.</p> <p>31. Tx (Average) (double) [dBm rms] Averaged Tx power.</p>

Index: n <Mnemonic>	Results Returned
2	I/Q Measured Polar Data Trace (float) [volt] <2 * number of carriers * number of symbols> Returns normalized I/Q trace data of captured symbols, as a series of trace point values, in volts. The I values are even-indexed values listed first in each pair. The Q values are the odd-indexed values.
3	MER vs. Sub-carrier (float) [dB] <3077> Returns MER vs. Sub-carrier data, as a series of comma-separated trace points. The result is a series of floating point numbers.
4	Amptd vs. Sub-carrier (float) [dB] <3077> Returns amplitude vs. sub-carrier data, as a series of comma-separated trace points. The result is a series of floating point numbers.
5	Phase vs. Sub-carrier (float) [°] <3077> Returns phase vs. sub-carrier data, as a series of comma-separated trace points. The result is a series of floating point numbers.
6	Group Delay vs. Sub-carrier (float) [us] <3076> Returns group delay vs. sub-carrier data, as a series of comma-separated trace points. The result is a series of floating point numbers.
7	Amptd vs. Time (float) [dB] <4096> Returns amplitude vs. time data, as a series of comma-separated trace points. The result is a series of floating point numbers.
8	MER vs. Timeslot (double) [dB] <40> Returns MER vs. Timeslot result, as a series of comma-separated trace points. Forty values are corresponding to the MER of timeslot 0~39 orderly. The value '-999' indicates that the MER of the corresponding timeslot couldn't be obtained.
9	EVM vs. Sub-carrier (float) [%] <3077> Returns EVM vs. Sub-carrier data, as a series of comma-separated trace points. The result is a series of floating point numbers.

Mod Accuracy Measurement Description

Mod Accuracy Measurement provides the properties and methods for measuring the modulation errors in CMMB. This measurement covers the following results:

- Constellation graph for configurable sub-carrier ranges
- EVM/MER vs. Subcarrier/Frequency, Magnitude error, Phase error
- Frequency Error, Quadrature Error, Amplitude Imbalance, Timing Skew
- Channel Frequency Response and Channel Impulse Response
- Spectral Flatness

NOTE All the positions (sub-carrier index) are given according to the following sub-carrier structure.

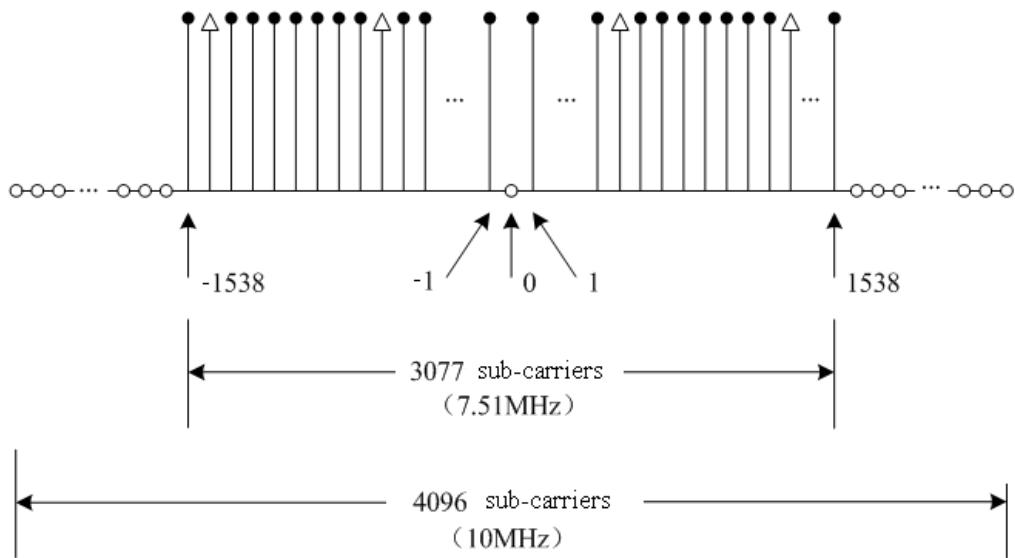
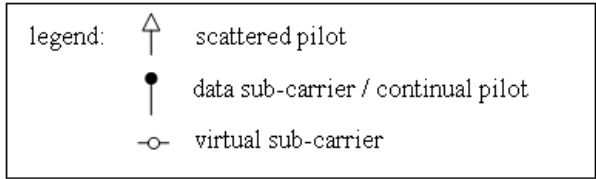

Key Path	Meas
Initial S/W Revision	A.03.00

Amplitude (AMPTD) Y Scale

Sets the desired vertical scale and associated settings. The settings available vary with each active window.

Key Path	Front-panel key
Initial S/W Revision	A.03.00

Ref Value

Sets the displayed Y reference value. The key is active in MER/EVM vs. Sub-carrier/Frequency Window, Amptd vs. Sub-carrier Window, Phase vs. Sub-carrier Window, Group Delay vs. Sub-carrier Window, and Amptd vs. Time Window.

Key Path	AMPTD Y Scale
Initial S/W Revision	A.03.00

Y Ref Value (I/Q Error View – MER/EVM vs. Sub-carrier/ Frequency Window)

This key sets the reference value in the MER/EVM vs. Sub-carrier/Frequency window. The displayed value will be updated according to the Scale Type (AMPTD Y Scale, More) as follows.

[“Y Ref Value \(Scale Type is ‘MER’\)” on page 636](#)

[“Y Ref Value \(Scale Type is ‘EVM’\)” on page 637](#)

Y Ref Value (Scale Type is ‘MER’)

If the scale type is set to MER, Y Ref Value is displayed and set in dB.

Key Path	AMPTD Y Scale
Mode	CMMB
Remote Command	:DISPlay:EVM:VIEW2:WINDow[1]:TRACe:Y[:SCALe][:MER]:RLEV e1 <real> :DISPlay:EVM:VIEW2:WINDow[1]:TRACe:Y[:SCALe][:MER]:RLEV e1?
Example	DISP:EVM:VIEW2:WIND:TRAC:Y:RLEV 0.0 DISP:EVM:VIEW2:WIND:TRAC:Y:RLEV?
Notes	SCPI Remarks: VIEW2: I/Q Error View WINDow[1]: MER/EVM vs. Sub-carrier/Frequency Window on I/Q Error View

Dependencies	If Auto Scaling is set to On, this value is automatically determined by the measurement result. When you set this value manually, Auto Scaling is automatically set to Off.
Preset	Result depends on input signal.
State Saved	No
Min	-500.0
Max	500.0
Initial S/W Revision	A.03.00
Modified at S/W Revision	A.06.00

Y Ref Value (Scale Type is 'EVM')

If the scale type is set to EVM, Y Ref Value is displayed and set in %.

Key Path	AMPTD Y Scale
Mode	CMMB
Remote Command	:DISPlay:EVM:VIEW2:WINDow[1]:TRACe:Y[:SCALe]:EVM:RLEVel <real> :DISPlay:EVM:VIEW2:WINDow[1]:TRACe:Y[:SCALe]:EVM:RLEVel ?
Example	DISP:EVM:VIEW2:WIND:TRAC:Y:EVM:RLEV 0.0 DISP:EVM:VIEW2:WIND:TRAC:Y:EVM:RLEV?
Notes	SCPI Remarks: VIEW2: I/Q Error View WINDow[1]: MER/EVM vs. Sub-carrier/Frequency Window on I/Q Error View
Dependencies	If Auto Scaling is set to On, this value is automatically determined by the measurement result. When you set this value manually, Auto Scaling is automatically set to Off.
Preset	Value is automatically determined by the measurement result with Auto Scaling set to On. Result depends on signal source
State Saved	No
Min	0.0
Max	500.0
Initial S/W Revision	A.06.00

Y Ref Value (Channel Frequency Response View / Spectral Flatness View – Amptd vs. Sub-carrier Window)

Sets the reference value in the Amptd vs. Sub-carrier window.

Key Path	AMPTD Y Scale
Mode	CMMB
Remote Command	:DISPlay:EVM:VIEW3 5 : WINDow [1] : TRACe:Y [: SCALe] : RLEVel <real> :DISPlay:EVM:VIEW3 5 : WINDow [1] : TRACe:Y [: SCALe] : RLEVel?
Example	DISP:EVM:VIEW3:WIND:TRAC:Y:RLEV 0.0 DISP:EVM:VIEW3:WIND:TRAC:Y:RLEV?
Notes	SCPI Remarks: VIEW3: Channel Frequency Response View VIEW5: Spectral Flatness View WINDow[1]: Amptd vs. Sub-carrier Window
Dependencies	If Auto Scaling is set to On, this value is automatically determined by the measurement result. When you set this value manually, Auto Scaling is automatically set to Off.
Preset	Result depends on input signal.
State Saved	No
Min	-100.0
Max	100.0
Initial S/W Revision	A.03.00

Y Ref Value (Channel Frequency Response View – Phase vs. Sub-carrier Window)

Sets the reference value in the Phase vs. Sub-carrier window.

Key Path	AMPTD Y Scale
Mode	CMMB
Remote Command	:DISPlay:EVM:VIEW3 : WINDow2 : TRACe:Y [: SCALe] : RLEVel <real> :DISPlay:EVM:VIEW3 : WINDow2 : TRACe:Y [: SCALe] : RLEVel?
Example	DISP:EVM:VIEW3:WIND2:TRAC:Y:RLEV 0.0 DISP:EVM:VIEW3:WIND2:TRAC:Y:RLEV?

Notes	SCPI Remarks: VIEW3: Channel Frequency Response View WINDow2: Phase vs. Sub-carrier Window on Channel Frequency Response View
Dependencies	If Auto Scaling is set to On, this value is automatically determined by the measurement result. When you set this value manually, Auto Scaling is automatically set to Off.
Preset	Result depends on input signal.
State Saved	No
Min	-180.0
Max	180.0
Initial S/W Revision	A.03.00

Y Ref Value (Channel Frequency Response View – Group Delay vs. Sub-carrier Window)

Sets the reference value in the Group Delay vs. Sub-carrier window.

Key Path	AMPTD Y Scale
Mode	CMMB
Remote Command	:DISPlay:EVM:VIEW3:WINDow3:TRACe:Y[:SCALE]:RLEVel <real> :DISPlay:EVM:VIEW3:WINDow3:TRACe:Y[:SCALE]:RLEVel?
Example	DISP:EVM:VIEW3:WIND3:TRAC:Y:RLEV 0.0 DISP:EVM:VIEW3:WIND3:TRAC:Y:RLEV?
Notes	SCPI Remarks: VIEW3: Channel Frequency Response View WINDow3: Group Delay vs. Sub-carrier Window on Channel Frequency Response View
Dependencies	If Auto Scaling is set to On, this value is automatically determined by the measurement result. When you set this value manually, Auto Scaling is automatically set to Off.
Preset	Result depends on input signal.
State Saved	No
Min	-5.0e6
Max	5.0e6
Initial S/W Revision	A.03.00

Y Ref Value (Channel Impulse Response View – Amptd vs. Time Window)

Sets the reference value in the Amptd vs. Time window.

Key Path	AMPTD Y Scale
Mode	CMMB
Remote Command	:DISPlay:EVM:VIEW4:WINDow[1]:TRACe:Y[:SCALe]:RLEVel <real> :DISPlay:EVM:VIEW4:WINDow[1]:TRACe:Y[:SCALe]:RLEVel?
Example	DISP:EVM:VIEW4:WIND:TRAC:Y:RLEV 0.0 DISP:EVM:VIEW4:WIND:TRAC:Y:RLEV?
Notes	SCPI Remarks: VIEW4: Channel Impulse Response View WINDow[1]: Amptd vs. Time Window on Channel Impulse Response View
Dependencies	If Auto Scaling is set to On, this value is automatically determined by the measurement result. When you set this value manually, Auto Scaling is automatically set to Off.
Preset	Result depends on input signal.
State Saved	No
Min	-500.0
Max	100.0
Initial S/W Revision	A.03.00

Attenuation

Accesses a menu of functions that to change attenuation settings. This key has read-back text that describes the total attenuator value.

See [“Attenuation” on page 910](#) in the section "Common Measurement Functions" for more information.

Range

Accesses the Range menu to change baseband I/Q gain settings. This key has a read-back text that describes gain range value. This key is available when you have installed Option BBA (BBIQ hardware).

See [“Range” on page 919](#) in the section "Common Measurement Functions" for more information.

Scale/Div

Sets Y Scale/Div. The key is active in MER/EVM vs. Sub-carrier/Frequency Window, Amptd vs. Sub-carrier Window, Phase vs. Sub-carrier Window, Group Delay vs. Sub-carrier Window, and Amptd

vs. Time Window.

Key Path	AMPTD Y Scale
Initial S/W Revision	A.03.00

Y Scale/Div (I/Q Error View – MER/EVM vs. Sub-carrier/ Frequency Window)

This key sets the sensitivity of the measurement result in the MER/EVM vs. Sub-carrier/Frequency window. The displayed value will be updated according to the Scale Type (AMPTD Y Scale, More) as follows:

[“Y Scale/Div \(Scale Type is ‘MER’\)” on page 641](#)

[“Y Scale/Div \(Scale Type is ‘EVM’\)” on page 642](#)

Y Scale/Div (Scale Type is ‘MER’)

If the scale type is set to MER, Y Scale/Div is displayed and set in dB.

Key Path	AMPTD Y Scale
Mode	CMMB
Remote Command	:DISPlay:EVM:VIEW2:WINDow[1]:TRACe:Y[:SCALe][:MER]:PDIV ision <real> :DISPlay:EVM:VIEW2:WINDow[1]:TRACe:Y[:SCALe][:MER]:PDIV ision?
Example	DISP:EVM:VIEW2:WIND:TRAC:Y:PDIV 10.0 DISP:EVM:VIEW2:WIND:TRAC:Y:PDIV?
Notes	SCPI Remarks: VIEW2: I/Q Error View WINDow[1]: MER/EVM vs. Sub-carrier/Frequency Window on I/Q Error View
Dependencies	If Auto Scaling is set to On, this value is automatically determined by the measurement result. When you set this value manually, Auto Scaling is automatically set to Off.
Preset	Result depends on input signal.
State Saved	No
Min	0.1
Max	40.0
Initial S/W Revision	A.03.00
Modified at S/W Revision	A.06.00

Y Scale/Div (Scale Type is 'EVM')

If the scale type is set to EVM, Y Scale/Div is displayed and set in %.

Key Path	AMPTD Y Scale
Mode	CMMB
Remote Command	:DISPlay:EVM:VIEW2:WINDow[1]:TRACe:Y[:SCALe]:EVM:PDIVis ion <real> :DISPlay:EVM:VIEW2:WINDow[1]:TRACe:Y[:SCALe]:EVM:PDIVis ion?
Example	DISP:EVM:VIEW2:WIND:TRAC:Y:EVM:PDIV 10.0 DISP:EVM:VIEW2:WIND:TRAC:Y:EVM:PDIV?
Notes	SCPI Remarks: VIEW2: I/Q Error View WINDow[1]: MER/EVM vs. Sub-carrier/Frequency Window on I/Q Error View
Dependencies	If Auto Scaling is set to On, this value is automatically determined by the measurement result. When you set this value manually, Auto Scaling is automatically set to Off.
Preset	Value is automatically determined by the measurement result with Auto Scaling set to On. Result depends on signal source
State Saved	No
Min	0.01
Max	50.0
Initial S/W Revision	A.06.00

Y Scale/Div (Channel Frequency Response View / Spectral Flatness View – Amptd vs. Sub-carrier Window)

Sets the sensitivity of measurement result in the Amptd vs. Sub-carrier window.

Key Path	AMPTD Y Scale
Mode	CMMB
Remote Command	:DISPlay:EVM:VIEW3 5:WINDow[1]:TRACe:Y[:SCALe]:PDIVisio n <real> :DISPlay:EVM:VIEW3 5:WINDow[1]:TRACe:Y[:SCALe]:PDIVisio n?
Example	DISP:EVM:VIEW3:WIND:TRAC:Y:PDIV 10.0 DISP:EVM:VIEW3:WIND:TRAC:Y:PDIV?

Notes	SCPI Remarks: VIEW3: Channel Frequency response View VIEW5: Spectral Flatness View WINDow[1]: Amptd vs. Sub-carrier Window
Dependencies	If Auto Scaling is set to On, this value is automatically determined by the measurement result. When you set this value manually, Auto Scaling is automatically set to Off.
Preset	Result depends on input signal.
State Saved	No
Min	0.01
Max	40.0
Initial S/W Revision	A.03.00

Y Scale/Div (Channel Frequency Response View – Phase vs. Sub-carrier Window)

Sets the sensitivity of measurement result in the Phase vs. Sub-carrier window.

Key Path	AMPTD Y Scale
Mode	CMMB
Remote Command	:DISPlay:EVM:VIEW3:WINDow2:TRACe:Y[:SCALE]:PDIVision <real> :DISPlay:EVM:VIEW3:WINDow2:TRACe:Y[:SCALE]:PDIVision?
Example	DISP:EVM:VIEW3:WIND2:TRAC:Y:PDIV 36.0 DISP:EVM:VIEW3:WIND2:TRAC:Y:PDIV?
Notes	SCPI Remarks: VIEW3: Channel Frequency Response View WINDow2: Phase vs. Sub-carrier Window on Channel Frequency Response View
Dependencies	If Auto Scaling is set to On, this value is automatically determined by the measurement result. When you set this value manually, Auto Scaling is automatically set to Off.
Preset	Result depends on input signal.
State Saved	No
Min	0.001
Max	50.0
Initial S/W Revision	A.03.00

Y Scale/Div (Channel Frequency Response View – Group Delay vs. Sub-carrier Window)

Sets the sensitivity of measurement result in the Group Delay vs. Sub-carrier window.

Key Path	AMPTD Y Scale
Mode	CMMB
Remote Command	:DISPlay:EVM:VIEW3:WINDow3:TRACe:Y[:SCALe]:PDIVision <real> :DISPlay:EVM:VIEW3:WINDow3:TRACe:Y[:SCALe]:PDIVision?
Example	DISP:EVM:VIEW3:WIND3:TRAC:Y:PDIV 1.0 DISP:EVM:VIEW3:WIND3:TRAC:Y:PDIV?
Notes	SCPI Remarks: VIEW3: Channel Frequency Response View WINDow3: Group Delay vs. Sub-carrier Window on Channel Frequency Response View
Dependencies	If Auto Scaling is set to On, this value is automatically determined by the measurement result. When you set this value manually, Auto Scaling is automatically set to Off.
Preset	Result depends on input signal.
State Saved	No
Min	0.01
Max	1.0e6
Initial S/W Revision	A.03.00

Y Scale/Div (Channel Impulse Response View – Amptd vs. Time Window)

Sets the sensitivity of measurement result in the Amptd vs. Time window.

Key Path	AMPTD Y Scale
Mode	CMMB
Remote Command	:DISPlay:EVM:VIEW4:WINDow[1]:TRACe:Y[:SCALe]:PDIVision <real> :DISPlay:EVM:VIEW4:WINDow[1]:TRACe:Y[:SCALe]:PDIVision?
Example	DISP:EVM:VIEW4:WIND:TRAC:Y:PDIV 10.0 DISP:EVM:VIEW4:WIND:TRAC:Y:PDIV?
Notes	SCPI Remarks: VIEW4: Channel Impulse Response View WINDow[1]: Amptd vs. Time Window on Channel Impulse Response View

Dependencies	If Auto Scaling is set to On, this value is automatically determined by the measurement result. When you set this value manually, Auto Scaling is automatically set to Off.
Preset	Result depends on input signal.
State Saved	No
Min	0.1
Max	40.0
Initial S/W Revision	A.03.00

Presel Center

Optimizes the preselector settings for the current measurement.

See AMPTD Y Scale, “[Presel Center](#)” on page 926 in the section "Common Measurement Functions" for more information. This function is only available when the selected input is RF.

Presel Adjust

Adjusts the preselector settings for the current measurement.

See AMPTD Y Scale, “[Preselector Adjust](#)” on page 927 in the section "Common Measurement Functions" for more information. This function is only available when the selected input is RF.

Scale Type

Sets Y Scale Type. This key is visible only when the current window is MER/EVM vs. Sub-carrier/Frequency window. If it is set to ‘MER’, the Y scale displays the MER value. If it is set to ‘EVM’, the Y scale displays the EVM value.

Parameter Name	Y Scale Type
Key Path	AMPTD Y Scale, More
Parameter Type	Enum Binary
Mode	CMMB
Remote Command	:DISPlay:EVM:VIEW2:WINDow [1] : TRACe:Y [:SCALE] : TYPE MER EVM :DISPlay:EVM:VIEW2:WINDow [1] : TRACe:Y [:SCALE] : TYPE?
Example	DISP:EVM:VIEW2:WIND:TRAC:Y:TYPE MER DISP:EVM:VIEW2:WIND:TRAC:Y:TYPE?
Preset	MER
Force Restart	No
State Saved	No

Mod Accuracy Measurement
Amplitude (AMPTD) Y Scale

Range	MER EVM
Initial S/W Revision	A.06.00
Softkey Label	Scale Type

Internal Preamp

Controls the internal preamplifier. Turning Internal Preamp on gives a better noise figure, but a poorer inter-modulation distortion (TOI) to noise floor dynamic range. You can optimize this setting for your particular measurement. See AMPTD Y Scale “[Internal Preamp](#)” on page 939 in the section "Common Measurement Functions" for more information.

Ref Position

Sets the display reference position to Top, Ctr (center), or Bot (bottom). The key is active in MER/EVM vs. Sub-carrier/Frequency Window, Amptd vs. Sub-carrier Window, Phase vs. Sub-carrier Window, Group Delay vs. Sub-carrier Window, and Amptd vs. Time Window.

Key Path	AMPTD Y Scale
Initial S/W Revision	A.03.00

Y Ref Position (I/Q Error View – MER/EVM vs. Sub-carrier/Frequency Window)

Sets the Y axis reference position in the MER/EVM vs. Sub-carrier/Frequency window.

Key Path	AMPTD Y Scale, More
Mode	CMMB
Remote Command	:DISPlay:EVM:VIEW2:WINDow[1]:TRACe:Y[:SCALe]:RPOSition TOP CENTer BOTTom :DISPlay:EVM:VIEW2:WINDow[1]:TRACe:Y[:SCALe]:RPOSition?
Example	DISP:EVM:VIEW2:WIND:TRAC:Y:RPOS TOP DISP:EVM:VIEW2:WIND:TRAC:Y:RPOS?
Notes	SCPI Remarks: VIEW2: I/Q Error View WINDow[1]: MER/EVM vs. Sub-carrier/Frequency Window on I/Q Error View
Preset	TOP
State Saved	No
Range	Top Ctr Bot
Initial S/W Revision	A.03.00

Y Ref Position (Channel Frequency Response View / Spectral Flatness View – Amptd vs. Sub-carrier Window)

Sets the Y axis reference position in the Amptd vs. Sub-carrier window.

Key Path	AMPTD Y Scale, More
Mode	CMMB
Remote Command	:DISPlay:EVM:VIEW3 5:WINDow [1] :TRACe:Y[:SCALe]:RPOSitio n TOP CENTer BOTTom :DISPlay:EVM:VIEW3 5:WINDow [1] :TRACe:Y[:SCALe]:RPOSitio n?
Example	DISP:EVM:VIEW3:WIND:TRAC:Y:RPOS TOP DISP:EVM:VIEW3:WIND:TRAC:Y:RPOS?
Notes	SCPI Remarks: VIEW3: Channel Frequency Response View VIEW5: Spectral Flatness View WINDow[1]: Amptd vs. Sub-carrier Window on Channel Frequency Response View
Preset	TOP
State Saved	No
Range	Top Ctr Bot
Initial S/W Revision	A.03.00

Y Ref Position (Channel Frequency Response View – Phase vs. Sub-carrier Window)

Sets the Y axis reference position in the Phase vs. Sub-carrier window.

Key Path	AMPTD Y Scale, More
Mode	CMMB
Remote Command	:DISPlay:EVM:VIEW3:WINDow2:TRACe:Y[:SCALe]:RPOSitio TOP CENTer BOTTom :DISPlay:EVM:VIEW3:WINDow2:TRACe:Y[:SCALe]:RPOSitio?
Example	DISP:EVM:VIEW3:WIND2:TRAC:Y:RPOS CENT DISP:EVM:VIEW3:WIND2:TRAC:Y:RPOS?
Notes	SCPI Remarks: VIEW3: Channel Frequency Response View WINDow2: Phase vs. Sub-carrier Window on Channel Frequency Response View
Preset	CENT

Mod Accuracy Measurement
Amplitude (AMPTD) Y Scale

State Saved	No
Range	Top Ctr Bot
Initial S/W Revision	A.03.00

Y Ref Position (Channel Frequency Response View –Group Delay vs. Sub-carrier Window)

Sets the Y axis reference position in the Group Delay vs. Sub-carrier window.

Key Path	AMPTD Y Scale, More
Mode	CMMB
Remote Command	:DISPlay:EVM:VIEW3:WINDow3:TRACe:Y[:SCALe]:RPOSition TOP CENTer BOTTom :DISPlay:EVM:VIEW3:WINDow3:TRACe:Y[:SCALe]:RPOSition?
Example	DISP:EVM:VIEW3:WIND3:TRAC:Y:RPOS CENT DISP:EVM:VIEW3:WIND3:TRAC:Y:RPOS?
Notes	SCPI Remarks: VIEW3: Channel Frequency Response View WINDow3: Group Delay vs. Sub-carrier Window on Channel Frequency Response View
Preset	CENT
State Saved	No
Range	Top Ctr Bot
Initial S/W Revision	A.03.00

Y Ref Position (Channel Impulse Response View – Amptd vs. Time Window)

Sets the Y axis reference position in the Amptd vs. Time window.

Key Path	AMPTD Y Scale, More
Mode	CMMB
Remote Command	:DISPlay:EVM:VIEW4:WINDow[1]:TRACe:Y[:SCALe]:RPOSition TOP CENTer BOTTom :DISPlay:EVM:VIEW4:WINDow[1]:TRACe:Y[:SCALe]:RPOSition?
Example	DISP:EVM:VIEW4:WIND:TRAC:Y:RPOS TOP DISP:EVM:VIEW4:WIND:TRAC:Y:RPOS?
Notes	SCPI Remarks: VIEW4: Channel Impulse Response View WINDow[1]: Amptd vs. Time Window on Channel Impulse Response View

Preset	TOP
State Saved	No
Range	Top Ctr Bot
Initial S/W Revision	A.03.00

Auto Scaling

Toggles the scale coupling function between On and Off. The key is active in MER/EVM vs. Sub-carrier/Frequency Window, Amptd vs. Sub-carrier Window, Phase vs. Sub-carrier Window, Group Delay vs. Sub-carrier Window, and Amptd vs. Time Window.

Key Path	AMPTD Y Scale
Initial S/W Revision	A.03.00

Y Auto Scaling (I/Q Error View – MER/EVM vs. Sub-carrier/Frequency Window)

When Auto Scaling is On, the reference value and scale per division are automatically adjusted in the MER/EVM vs. Sub-carrier/Frequency window.

Key Path	AMPTD Y Scale, More
Mode	CMMB
Remote Command	:DISPlay:EVM:VIEW2:WINDow[1]:TRACe:Y[:SCALE]:COUPle OFF ON 0 1 :DISPlay:EVM:VIEW2:WINDow[1]:TRACe:Y[:SCALE]:COUPle?
Example	DISP:EVM:VIEW2:WIND:TRAC:Y:COUP OFF DISP:EVM:VIEW2:WIND:TRAC:Y:COUP?
Notes	SCPI Remarks: VIEW2: I/Q Error View WINDow[1]: MER/EVM vs. Sub-carrier/Frequency Window on I/Q Error View
Dependencies	When this parameter is set to On, it will activate the scale coupling function that automatically determines scale per division and reference values based on the measurement results. When you set a value to either Scale/Div or Ref Value manually, Auto Scaling is automatically set to Off.
Preset	ON
State Saved	No
Range	On Off
Initial S/W Revision	A.03.00

Y Auto Scaling (Channel Frequency Response View / Spectral Flatness View – Amptd vs. Sub-carrier Window)

When Auto Scaling is On, the reference value and scale per division are automatically adjusted in the Amptd vs. Sub-carrier window.

Key Path	AMPTD Y Scale, More
Mode	CMMB
Remote Command	:DISP:ay:EVM:VIEW3 5:WINDow[1]:TRACe:Y[:SCALe]:COUPle OFF ON 0 1 :DISP:ay:EVM:VIEW3 5:WINDow[1]:TRACe:Y[:SCALe]:COUPle?
Example	DISP:EVM:VIEW3:WIND:TRAC:Y:COUP OFF DISP:EVM:VIEW3:WIND:TRAC:Y:COUP?
Notes	SCPI Remarks: VIEW3: Channel Frequency Response View VIEW5: Spectral Flatness View WINDow[1]: Amptd vs. Sub-carrier Window
Dependencies	When this parameter is set to On, it will activate the scale coupling function that automatically determines scale per division and reference values based on the measurement results. When you set a value to either Scale/Div or Ref Value manually, Auto Scaling is automatically set to Off.
Preset	ON
State Saved	No
Range	On Off
Initial S/W Revision	A.03.00

Y Auto Scaling (Channel Frequency Response View – Phase vs. Sub-carrier Window)

When Auto Scaling is On, the reference value and scale per division are automatically adjusted in the Phase vs. Sub-carrier window.

Key Path	AMPTD Y Scale, More
Mode	CMMB
Remote Command	:DISP:ay:EVM:VIEW3:WINDow2:TRACe:Y[:SCALe]:COUPle OFF ON 0 1 :DISP:ay:EVM:VIEW3:WINDow2:TRACe:Y[:SCALe]:COUPle?
Example	DISP:EVM:VIEW3:WIND2:TRAC:Y:COUP OFF DISP:EVM:VIEW3:WIND2:TRAC:Y:COUP?

Notes	SCPI Remarks: VIEW3: Channel Frequency Response View WINDow2: Phase vs. Sub-carrier Window on Channel Frequency Response View
Dependencies	When this parameter is set to On, it will activate the scale coupling function that automatically determines scale per division and reference values based on the measurement results. When you set a value to either Scale/Div or Ref Value manually, Auto Scaling is automatically set to Off.
Preset	ON
State Saved	No
Range	On Off
Initial S/W Revision	A.03.00

Y Auto Scaling (Channel Frequency Response View –Group Delay vs. Sub-carrier Window)

When Auto Scaling is On, the reference value and scale per division are automatically adjusted in the Group Delay vs. Sub-carrier window.

Key Path	AMPTD Y Scale, More
Mode	CMMB
Remote Command	:DISPlay:EVM:VIEW3:WINDow3:TRACe:Y[:SCALE]:COUPle OFF ON 0 1 :DISPlay:EVM:VIEW3:WINDow3:TRACe:Y[:SCALE]:COUPle?
Example	DISP:EVM:VIEW3:WIND3:TRAC:Y:COUP OFF DISP:EVM:VIEW3:WIND3:TRAC:Y:COUP?
Notes	SCPI Remarks: VIEW3: Channel Frequency Response View WINDow3: Group Delay vs. Sub-carrier Window on Channel Frequency Response View
Dependencies	When this parameter is set to On, it will activate the scale coupling function that automatically determines scale per division and reference values based on the measurement results. When you set a value to either Scale/Div or Ref Value manually, Auto Scaling is automatically set to Off.
Preset	ON
State Saved	No
Range	On Off
Initial S/W Revision	A.03.00

Y Auto Scaling (Channel Impulse Response View – Amptd vs. Time Window)

When Auto Scaling is On, the reference value and scale per division are automatically adjusted in the Amptd vs. Time window.

Key Path	AMPTD Y Scale, More
Mode	CMMB
Remote Command	:DISPlay:EVM:VIEW4:WINDow[1]:TRACe:Y[:SCALe]:COUPle OFF ON 0 1 :DISPlay:EVM:VIEW4:WINDow[1]:TRACe:Y[:SCALe]:COUPle?
Example	DISP:EVM:VIEW4:WIND:TRAC:Y:COUP OFF DISP:EVM:VIEW4:WIND:TRAC:Y:COUP?
Notes	SCPI Remarks: VIEW4: Channel Impulse Response View WINDow[1]: Amptd vs. Time Window on Channel Impulse Response View
Dependencies	When this parameter is set to On, it will activate the scale coupling function that automatically determines scale per division and reference values based on the measurement results. When you set a value to either Scale/Div or Ref Value manually, Auto Scaling is automatically set to Off.
Preset	ON
State Saved	Saved in instrument state.
Range	On Off
Initial S/W Revision	A.03.00

Auto Couple

See “[Auto Couple](#)” on page 943 in the section "Common Measurement Functions" for more information.

BW

There is no BW functionality for this measurement.

Key Path	Front-panel key
Initial S/W Revision	A.03.00

Cont

See “[Cont \(Continuous Measurement/Sweep\)](#)” on page 957 in the section "Common Measurement Functions" for more information.

FREQ Channel

See “[FREQ Channel](#)” on page 959 in the section "Common Measurement Functions" for more information.

Input/Output

See [“Input/Output” on page 969](#) in the section "Common Measurement Functions" for more information.

Marker

Accesses a menu to select, set up, and control the markers for the current measurement.

See “[Marker](#)” on page 1039 in the section "Common Measurement Functions" for more information.

Select Marker

Accesses a menu to select, set up and control the markers for the current measurement.

Key Path	Marker
Initial S/W Revision	A.03.00

Marker Type

Sets the marker control mode. If the selected marker is Off, pressing Marker sets it to Normal and places it at the center of the screen on the trace of the selected window. At the same time, reference value of the selected marker appears on the Active Function area.

Active Function Display:

Marker X-axis value

Default Active Function: the active function for the selected marker’s current control mode. If the current control mode is Off, there is no active function and the active function is turned off.

The marker X axis value entered in the active function area displays the marker value to its full entered precision.

Key Path	Marker
Mode	CMMB
Remote Command	:CALCulate:EVM:MARKer [1] 2 3 4 5 6 7 8 9 10 11 12 :MODE POSition DELta OFF :CALCulate:EVM:MARKer [1] 2 3 4 5 6 7 8 9 10 11 12 :MODE?
Example	CALC:EVM:MARK:MODE POS CALC:EVM:MARK:MODE?

Notes	<p>Restrictions Information:</p> <p>If the selected marker is Off, pressing Marker sets it to Normal and places it at the center or left of the screen on the trace of the selected window. At the same time, Marker X Axis Value appears on the Active Function area.</p> <p>Default Active Function: the active function for the selected marker's current control mode. If the current control mode is Off, there is no active function and the active function is turned off.</p> <p>Active Function Display:</p> <p>Marker X-axis value</p> <p>the marker X axis value entered in the active function area will display the marker value to its full entered precision.</p> <p>SCPI Remarks:</p> <p>NORMal is changed to POSition in the new SA.</p>
Preset	OFF
State Saved	Saved in instrument state.
Range	Normal Delta Off
Initial S/W Revision	A.03.00

Marker X Axis Value (Remote Command only)

Sets the marker X Axis value in the current marker X Axis Scale unit. It has no effect if the marker type is **Off**, but is the SCPI equivalent of entering an X value if the marker type is **Normal** or **Delta**.

Mode	CMMB
Remote Command	<pre>:CALCulate:EVM:MARKer [1] 2 3 4 5 6 7 8 9 10 11 12 :X <real> :CALCulate:EVM:MARKer [1] 2 3 4 5 6 7 8 9 10 11 12 :X?</pre>
Example	<pre>CALC:EVM:MARK3:X 0.0 CALC:EVM:MARK3:X?</pre>
Notes	<p>Restrictions Information:</p> <p>The marker X Axis value has no unit suffix. For capture time data trace, the unit is second.</p> <p>The query returns the marker's absolute X Axis value if the control mode is Normal, or the offset from the marker's reference marker if the control mode is Delta. The query is returned without unit suffix.</p> <p>Depending on the trace, the SCPI Command/Query will support/return a sub-carrier value, a frequency value or a time value.</p>
Preset	After a preset, all Markers are turned OFF, so Marker X Axis Value query will return a not a number (NAN).

State Saved	No
Min	-9.9E+37
Max	9.9E+37
Initial S/W Revision	A.03.00

Marker X Axis Position (Remote Command only)

Sets the marker X position in trace points. It has no effect if the marker type is **Off**, but is the SCPI equivalent of entering a value if the marker type is **Normal** or **Delta** - except in trace points rather than X Axis Scale units. The entered value is immediately translated into the current X Axis Scale units for setting the value of the marker.

Mode	CMMB
Remote Command	:CALCulate:EVM:MARKer [1] 2 3 4 5 6 7 8 9 10 11 12 :X: POS ition <real> :CALCulate:EVM:MARKer [1] 2 3 4 5 6 7 8 9 10 11 12 :X: POS ition?
Example	CALC:EVM:MARK10:X:POS 0 CALC:EVM:MARK10:X:POS?
Preset	After a preset, all Markers are turned OFF, so Marker X Axis Value query will return a not a number (NAN).
State Saved	No
Min	-9.9E+37
Max	9.9E+37
Initial S/W Revision	A.03.00

Marker Y Axis Value (Remote Command only)

Queries the marker Y Axis value in the current marker Y Axis unit.

Mode	CMMB
Remote Command	:CALCulate:EVM:MARKer [1] 2 3 4 5 6 7 8 9 10 11 12 :Y?
Example	CALC:EVM:MARK11:Y?
Preset	Result depends on markers setup and signal source.
State Saved	No
Initial S/W Revision	A.03.00

Properties

Accesses a menu to select a relative maker and marker trace.

Key Path	Marker
Initial S/W Revision	A.03.00

Select Marker

Accesses a menu to select, set up and control the markers for the current measurement.

Key Path	Marker, Properties
Initial S/W Revision	A.03.00

Relative To

Selects the marker the selected marker will be relative to (its reference marker).

Key Path	Marker, Properties
Mode	CMMB
Remote Command	:CALCulate:EVM:MARKer [1] 2 3 4 5 6 7 8 9 10 11 12 :REFerence <integer> :CALCulate:EVM:MARKer [1] 2 3 4 5 6 7 8 9 10 11 12 :REFerence?
Example	CALC:EVM:MARK:REF 4 CALC:EVM:MARK:REF?
Notes	SCPI Remarks: When queried a single value will be returned (the specified marker numbers relative marker). Since a marker cannot be relative to itself, that choice is grayed out, and if sent from SCPI generates error -221: "Settings conflict; marker cannot be relative to itself."
Preset	2 3 4 5 6 7 8 9 10 11 12 1
State Saved	Saved in instrument state.
Min	1
Max	12
Initial S/W Revision	A.03.00

Marker Trace

Assigns the specified marker to a designated trace.

In the CMMB Modulation Accuracy measurement, there are six named traces. If the marker is not Off,

Mod Accuracy Measurement
Marker

you can move the marker from the trace it was on to the selected trace using Marker Trace panel. The marker will retain its relative horizontal positions in the new window.

If the marker is Off, it stays off, but is now associated with the specified trace.

The query returns the name of the trace on which the marker is currently placed.

Key Path	Marker, Properties
Mode	CMMB
Remote Command	:CALCulate:EVM:MARKer [1] 2 3 4 5 6 7 8 9 10 11 12 :TRACe POLar MVCarrIer AVCarrIer PVCarrIer GDVCarrIer AVTime :CALCulate:EVM:MARKer [1] 2 3 4 5 6 7 8 9 10 11 12 :TRACe ?
Example	CALC:EVM:MARK:TRACE MVC CALC:EVM:MARK:TRACE?
Preset	MVC
State Saved	Saved in instrument state.
Range	Polar Trace MER/EVM vs. Carr/Freq Amptd vs. Carr Phase vs. Carr GD vs. Carr Amptd vs. Time
Initial S/W Revision	A.03.00

Couple Markers

Toggles the state of the markers between coupling on and off. When this function is active (On), moving any marker causes an “equal X-axis movement” of every other marker that is not set to **Off**. “Equal X Axis movement” means that the differences between the coupled markers’ X Axis value (in the fundamental x-axis units of the trace that marker is on) are preserved and the X Axis value of each marker is moved (in the same fundamental x-axis units).

This can result in markers going offscreen.

Key Path	Marker, More
Mode	CMMB
Remote Command	:CALCulate:EVM:MARKer:COUPlE [:STATe] OFF ON 0 1 :CALCulate:EVM:MARKer:COUPlE [:STATe] ?
Example	CALC:EVM:MARK:COUP ON CALC:EVM:MARK:COUP?
Preset	OFF
State Saved	Saved in instrument state.
Range	On Off
Initial S/W Revision	A.03.00

All Markers Off

Turns off all markers.

Key Path	Marker, More
Mode	CMMB
Remote Command	:CALCulate:EVM:MARKer:AOFF
Example	CALC:EVM:MARK:AOFF
Initial S/W Revision	A.03.00

Marker Function

There are no Marker Function operations supported in the Modulation Accuracy measurement. The front-panel key displays a blank menu when pressed.

Key Path	Front-panel key
Initial S/W Revision	A.03.00

Marker To

There is no Marker To operations supported in the Modulation Accuracy measurement. The front-panel key will display a blank menu when pressed.

Key Path	Front-panel key
Initial S/W Revision	A.03.00

Meas

See “[Meas](#)” on page 1083 in the section "Common Measurement Functions" for more information.

Meas Setup

Displays the measurement setup menu for the Modulation Accuracy measurement when the Modulation Accuracy measurement is selected in the Meas menu.

Key Path	Front-panel key
Initial S/W Revision	A.03.00

Avg/Hold Num

This key sets the number of measurements to be averaged. After the specified numbers (average counts) have been averaged, the averaging mode (termination control) setting determines the averaging action.

Key Path	Meas Setup
Mode	CMMB
Remote Command	[:SENSe] :EVM:AVErAge:COUNt <integer> [:SENSe] :EVM:AVErAge:COUNt? [:SENSe] :EVM:AVErAge [:STATe] OFF ON 0 1 [:SENSe] :EVM:AVErAge [:STATe] ?
Example	EVM:AVER:COUN 100 EVM:AVER:COUN? EVM:AVER OFF EVM:AVER?
Preset	10 OFF
State Saved	Saved in instrument state.
Min	1
Max	10000
Initial S/W Revision	A.03.00

Avg Mode

Selects the type of termination control used for the averaging function. This determines the averaging action after the specified number of data acquisitions (average count) is reached. You can select between the Exp (exponential) and Repeat averaging modes. This selection only affects the averaging result after the number of N averages is reached. You can use the Avg/Hold Num key to set N.

KEY: Exponential averaging SCPI: EXPonential	When Measure is set at Cont, data acquisitions will continue indefinitely. After N averages, exponential averaging is used with a weighting factor of N (the displayed average count stops at N). Exponential averaging weights new data more than old data, which allows tracking of slow-changing signals.
KEY: Repeat averaging SCPI: REPeat	When Measure is set at Cont, data acquisitions will continue indefinitely. After N averages is reached, all previous result data is cleared and the average count is set back to 1. This is equivalent to being in Measure Single and pressing the Restart key when the Single measurement finishes.

Key Path	Meas Setup
Mode	CMMB
Remote Command	[[:SENSE]:EVM:AVERage:TCONtrol EXPonential REPeat [:SENSE]:EVM:AVERage:TCONtrol?
Example	EVM:AVER:TCON EXP EVM:AVER:TCON?
Preset	EXPonential
State Saved	Saved in instrument state.
Range	Exp Repeat
Initial S/W Revision	A.03.00

Meas Type

Sets Meas Type. The available selection includes 'PLCH', 'Timeslot', and 'Frame'.

1. In 'PLCH', the measurement unit is one PLCH (Physics Logical Channel). You need to specify which PLCH is to be measured using the parameters under 'PLCH Settings' menu (Meas Setup).

TS0 is decoded first and the PLCH configuration (PLCH structure and modulation format) is detected automatically from TS0. Then, the specified PLCH can be demoded and the results of this PLCH are given.

2. In 'Timeslot', the measurement unit is a series of timeslots. You need to specify a timeslot range and modulation format using the parameters under 'Timeslot Settings' menu (Meas Setup). The results are given according to these settings.

NOTE The premise of this method is that the same modulation format is used in the specified timeslot range.

3. In 'Frame', the measurement unit is a frame. No other parameters need to be set.

Similar to PLCH method, TS0 is decoded first and the configuration of each PLCH can be obtained.

Then, the overall results of all PLCH in a whole frame are given. More time is consumed using this method.

Key Path	Meas Setup
Mode	CMMB
Remote Command	[:SENSe] :EVM:TYPE PLCH TS FRAMe [:SENSe] :EVM:TYPE?
Example	EVM:TYPE PLCH EVM:TYPE?
Dependencies	If the Meas Type is set to 'PLCH', the 'Timeslot Settings' key (Meas Setup) is grayed out. If the Meas Type is set to 'Timeslot', the 'PLCH Settings' key (Meas Setup) is grayed out. If the Meas Type is set to 'Frame', the following keys are grayed out: 'PLCH Settings', 'Timeslot Settings' (Meas Setup).
Couplings	If Trigger (on Front-panel) is changed to 'Free Run', the Meas Type will change to 'Timeslot' automatically. If the Meas Type is changed from 'Timeslot' to 'PLCH' or 'Frame' and the current trigger is 'Free Run', trigger will change to 'Periodic Timer' automatically.
Preset	PLCH
State Saved	Saved in instrument state.
Range	PLCH Timeslot Frame
Initial S/W Revision	A.03.00

PLCH Settings

Accesses a menu to specify PLCH settings.

Key Path	Meas Setup
Dependencies	If Meas Type (Meas Setup) is not 'PLCH', this key will be grayed out.
Initial S/W Revision	A.03.00

PLCH Type

Sets the type of PLCH (physical logical channel) to be analyzed. The available selections include CLCH and SLCH. This key is available only when Meas Type is 'PLCH'.

Key Path	Meas Setup, PLCH Settings
Mode	CMMB

Mod Accuracy Measurement
Meas Setup

Remote Command	[:SENSe] :EVM:PLCH:TYPE SLCH CLCH [:SENSe] :EVM:PLCH:TYPE?
Example	EVM:PLCH:TYPE SLCH EVM:PLCH:TYPE?
Dependencies	If the PLCH type is 'CLCH', the 'SLCH Index' key (Meas Setup, PLCH Settings) will be grayed out.
Preset	SLCH
State Saved	Saved in instrument state.
Range	SLCH CLCH
Initial S/W Revision	A.03.00

SLCH Index

Sets SLCH index. The selected SLCH will be analyzed. This key is available only when Meas Type is 'PLCH' and PLCH Type is 'SLCH'.

Key Path	Meas Setup, PLCH Settings
Mode	CMMB
Remote Command	[:SENSe] :EVM:PLCH:SLCH[:INDeX] <integer> [:SENSe] :EVM:PLCH:SLCH[:INDeX] ?
Example	EVM:PLCH:SLCH 0 EVM:PLCH:SLCH?
Dependencies	This key is grayed out if 'PLCH Type' (Meas Setup, PLCH Settings) is set to 'CLCH'.
Preset	0
State Saved	Saved in instrument state.
Min	0
Max	38
Initial S/W Revision	A.03.00

Timeslot Settings

Accesses a menu to specify Timeslot settings.

Key Path	Meas Setup
Dependencies	If Meas Type (Meas Setup) is not 'Timeslot', this key will be grayed out.
Initial S/W Revision	A.03.00

Start Timeslot

Sets the start timeslot to be analyzed. This key is available only when Meas Type is 'Timeslot'.

Key Path	Meas Setup, Timeslot Settings
Mode	CMMB
Remote Command	[:SENSe] :EVM:TS:STARt <integer> [:SENSe] :EVM:TS:STARt?
Example	EVM:TS:STAR 1 EVM:TS:STAR?
Dependencies	If Trigger (Front-panel) is set to 'Free Run', this key is grayed out.
Preset	1
State Saved	Saved in instrument state.
Min	0
Max	39
Initial S/W Revision	A.03.00

Meas Interval

Sets the number of the timeslots to be analyzed. This key is available only when Meas Type is 'Timeslot'.

Key Path	Meas Setup, Timeslot Settings
Mode	CMMB
Remote Command	[:SENSe] :EVM:TS:MINTerval <integer> [:SENSe] :EVM:TS:MINTerval?
Example	EVM:TS:MINT 1 EVM:TS:MINT?
Dependencies	If Trigger (Front-panel) is 'Free Run', this key is grayed out.
Preset	1
State Saved	Saved in instrument state.
Min	1
Max	40 – Start Timeslot
Initial S/W Revision	A.03.00

Modulation Format

Sets the modulation format of the selected Timeslots. The available selections include BPSK, QPSK, and

Mod Accuracy Measurement
Meas Setup

16QAM. This key is available only when Meas Type is 'Timeslot'.

Key Path	Meas Setup, Timeslot Settings
Mode	CMMB
Remote Command	[:SENSe] :EVM:TS:MODulation BPSK QPSK QAM16 [:SENSe] :EVM:TS:MODulation?
Example	EVM:TS:MOD QPSK EVM:TS:MOD?
Preset	QPSK
State Saved	Saved in instrument state.
Range	BPSK QPSK 16QAM
Initial S/W Revision	A.03.00

Advanced

Accesses a menu to specify advanced settings for Mod Accuracy measurement.

Key Path	Meas Setup
Initial S/W Revision	A.03.00

MER Limit

Sets the Pass/Fail limit for the MER results.

Key Path	Meas Setup, Advanced
Mode	CMMB
Remote Command	[:SENSe] :EVM:MERLimit <rel_ampl> [:SENSe] :EVM:MERLimit? [:SENSe] :EVM:MERLimit:AUTO ON OFF 1 0 [:SENSe] :EVM:MERLimit:AUTO?
Example	EVM:MERL 38.0 EVM:MERL? EVM:MERL:AUTO OFF EVM:MERL:AUTO?
Preset	38.0 ON
State Saved	Saved in instrument state.

Min	0.0
Max	50.0
Initial S/W Revision	A.03.00

Spectrum

Sets whether to use normal spectrum or inverted spectrum.

The Spectrum key is used when your signal's spectrum is inverted. In terms of the IQ complex components, to invert a spectrum in freq domain equals to conjugate the complex I/Q symbols in time domain.

$$(I + jQ)^* = I - jQ$$

This can often occur, for example, if you are measuring at an IF frequency, and the Q component of your baseband signal is inverted, or the I and Q signals are inadvertently swapped. When you set the spectrum key to Inverted, the analysis software will conjugate the complex baseband signal before demodulating, ensuring correct demodulation of the inverted signal.

Key Path	Meas Setup, Advanced
Mode	CMMB
Remote Command	[:SENSe] :EVM:SPECTrum NORMal INVert [:SENSe] :EVM:SPECTrum?
Example	EVM:SPEC NORM EVM:SPEC?
Preset	NORMal
State Saved	Saved in instrument state.
Range	Normal Invert
Initial S/W Revision	A.03.00

Clock Rate

Sets the clock rate either automatically based on the preset value or manually by your input value.

Key Path	Meas Setup, Advanced
Mode	CMMB
Remote Command	[:SENSe] :EVM:CLKRate <freq> [:SENSe] :EVM:CLKRate? [:SENSe] :EVM:CLKRate:AUTO ON OFF 1 0 [:SENSe] :EVM:CLKRate:AUTO?

Mod Accuracy Measurement
Meas Setup

Example	EVM:CLKR 10e6 EVM:CLKR? EVM:CLKR:AUTO OFF EVM:CLKR:AUTO?
Preset	10 MHz ON
State Saved	Saved in instrument state.
Min	9 MHz
Max	11 MHz
Initial S/W Revision	A.03.00

Demod Symbols Per Slot

Determines the capture length for calculation. More symbols provide more accurate results but require a longer processing time.

In CMMB, there are 53 symbols in one timeslot and 40 timeslots in one frame. The analyzing range may contain more than one timeslot. This parameter specifies how many symbols in every timeslot to be analyzed.

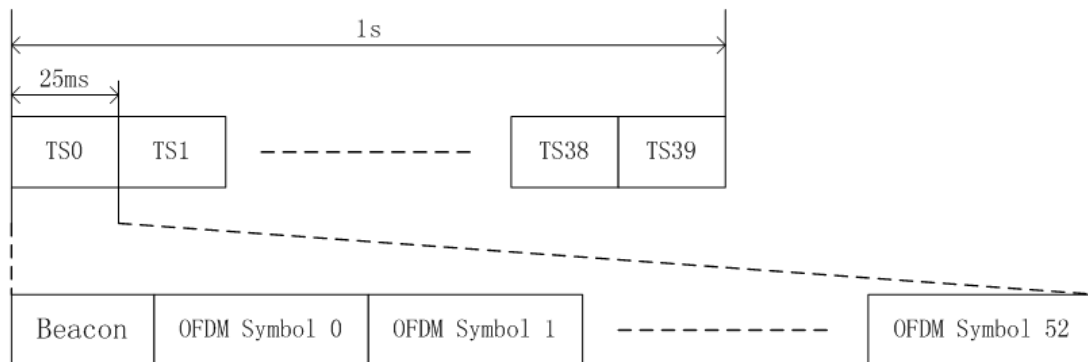

Key Path	Meas Setup, Advanced
Mode	CMMB
Remote Command	[:SENSE] :EVM:DSYMBOLS <integer> [:SENSE] :EVM:DSYMBOLS?
Example	EVM:DSYM 4 EVM:DSYM?
Preset	4
State Saved	Saved in instrument state.
Min	4

Max	53
Initial S/W Revision	A.03.00

Equalization

Toggles the equalization state between 'On' and 'Off'.

The equalization here is data equalization. If the Equalization state is On, both pilots and data subcarriers are used to calculate the channel effects. If the Equalization state is Off, only pilot subcarriers are used. Turning on the equalization can lead to a notable improvement on the MER results.

Key Path	Meas Setup, Advanced
Mode	CMMB
Remote Command	[:SENSe] :EVM:EQUalization:STATe OFF ON 0 1 [:SENSe] :EVM:EQUalization:STATe?
Example	EVM:EQU:STAT ON EVM:EQU:STAT?
Preset	OFF
State Saved	Saved in instrument state.
Range	On Off
Initial S/W Revision	A.03.00

Sync Frame Now

Synchronize the trigger with TS0, the beginning of a CMMB signal frame. Once pressed, the synchronization works.

The trigger here refers to two triggers, periodic timer (Trigger, Periodic Timer) and external trigger (Trigger, External 1). The operations of synchronization are different under these two triggers, as follows:

- Periodic Timer is the default setting and used when no 1 PPS is available. In this case, first set the internal periodic timer by pressing Trigger, More 1 of 2, Periodic Timer. Then press Sync Frame Now to calculate the difference between the internal periodic trigger and TS0, to adjust the internal periodic timer according to the difference and to demodulate the signal. It may take a few seconds. The difference between the adjusted internal periodic trigger and TS0 will be shown in Result Metrics view.
- External Trigger is used when there is a 1 PPS output on the transmitter/exciter under test. Connect the 1 PPS output to the Trigger 1 IN port of the signal analyzer. If the 1 PPS output is synchronized with TS0, the signal can be demodulated. You can see the logical channel decoding results, clear constellation and MER results in IQ Error view. If not, press Sync Frame Now to calculate the difference between the 1 PPS and TS0 and to compensate this value to demodulate the CMMB

Mod Accuracy Measurement
Meas Setup

signal. The difference will be shown in Result Metrics view.

Key Path	Meas Setup, Advanced
Mode	CMMB
Remote Command	[:SENSE] :EVM:SFRame [:IMMediate]
Example	EVM:SFR
Initial S/W Revision	A.03.00

Out of Band Filtering

Chooses whether to use out of band filter or not.

The filter is used to eliminate the impact of out of band signal.

Key Path	Meas Setup, Advanced, More
Mode	CMMB
Remote Command	[:SENSE] :EVM:OBFiltering OFF ON 0 1 [:SENSE] :EVM:OBFiltering?
Example	EVM:OBF OFF EVM:OBF?
Preset	OFF
State Saved	Saved in instrument state.
Range	On Off
Initial S/W Revision	A.03.00

FFT Start Position

Sets the start position of FFT.

‘FFT Start Position’ means how many parts of CP (Cyclic Prefix) are included in FFT. There are 9 values from 0/8 CP to 8/8 CP. As shown below, 0/8 CP means no CP is included in FFT and 8/8 CP means the entire CP is included in FFT.

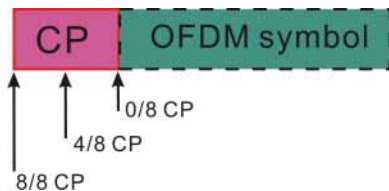

For a signal with pre-echo or delay waves, ISI (Inter-Symbol Interference) can be eliminated by adjusting FFT Start Position.

Choose appropriate FFT Start Position according to your channel delay profile to remove the effect of interferences. Together with Equalization (Meas Setup, Advanced), MER and Channel Impulse

Response results can be improved.

Key Path	Meas Setup, Advanced, More
Mode	CMMB
Remote Command	[:SENSe] :EVM:FFTStart CP08 CP18 CP28 CP38 CP48 CP58 CP68 CP78 CP88 [:SENSe] :EVM:FFTStart?
Example	EVM:FFTS CP18 EVM:FFTS?
Preset	CP18
State Saved	Saved in instrument state.
Range	0/8 CP 1/8 CP 2/8 CP 3/8 CP 4/8 CP 5/8 CP 6/8 CP 7/8 CP 8/8 CP
Initial S/W Revision	A.06.00

Meas Preset

Restores all the measurement settings to their defaults.

This will set the measure setup parameters for the currently selected measurement only, to the factory defaults.

Key Path	Meas Setup
Mode	CMMB
Remote Command	:CONFigure:EVM
Example	CONF:EVM
Couplings	Selecting measurement preset will restore all measurement parameters to their default values for the current measurement.
Initial S/W Revision	A.03.00

Mode

See “[Mode](#)” on page 1123 in the section "Common Measurement Functions" for more information.

Mode Setup

See [“Mode Setup” on page 1141](#) in the section "Common Measurement Functions" for more information.

Peak Search

Accesses a menu to control the peak search function and places a marker on the trace point with the highest peak.

Key Path	Front-panel key
Mode	CMMB
Remote Command	:CALCulate:EVM:MARKer [1] 2 3 4 5 6 7 8 9 10 11 12 :MAXimum
Example	CALC:EVM:MARK2:MAX
Initial S/W Revision	A.03.00

Next Peak

Moves the selected marker to the peak that has the next highest amplitude less than the marker's current value.

Key Path	Peak Search
Mode	CMMB
Remote Command	:CALCulate:EVM:MARKer [1] 2 3 4 5 6 7 8 9 10 11 12 :MAXimum:NEXT
Example	CALC:EVM:MARK2:MAX:NEXT
Initial S/W Revision	A.03.00

Next Pk Right

Moves the selected marker to the next peak to the right of the current marker.

Key Path	Peak Search
Mode	CMMB
Remote Command	:CALCulate:EVM:MARKer [1] 2 3 4 5 6 7 8 9 10 11 12 :MAXimum:RIGHT
Example	CALC:EVM:MARK2:MAX:RIGH
Initial S/W Revision	A.03.00

Next Pk Left

Moves the selected marker to the next peak to the left of the current marker.

Key Path	Peak Search
Mode	CMMB
Remote Command	:CALCulate:EVM:MARKer [1] 2 3 4 5 6 7 8 9 10 11 12 :MAXimum:LEFT
Example	CALC:EVM:MARK2:MAX:LEFT
Initial S/W Revision	A.03.00

Marker Delta

Sets the control mode for the selected marker to **Delta** mode.

Key Path	Peak Search
Initial S/W Revision	A.03.00

Peak Criteria

This key is visible only when current view is 'Channel Impulse Response' view.

Pressing this key opens the Peak Criteria menu and allows you to adjust the 'Pk Threshold' and 'Pk Excursion' parameters used for peak table.

For a signal to be identified as a peak it must meet certain criteria. If either the peak excursion or peak threshold functions are on, then the signal must satisfy those criteria before being identified as a peak.

NOTE The criteria only affects the peaks in Peak Table. It will not affect 'Peak Search', 'Next Peak', etc.

Key Path	Peak Search, More
Initial S/W Revision	A.06.00

Pk Excursion

This key is visible only when current view is 'Channel Impulse Response' view.

Turns the peak excursion requirement on/off and sets the excursion value. The value defines the minimum amplitude variation (rise and fall) required for a signal to be identified as peak.

When both 'Pk Excursion' and 'Pk Threshold' are on, a signal must rise above the 'Pk Threshold' value by at least the Peak Excursion value and then fall back from its local maximum by at least the Peak Excursion value to be considered a peak.

NOTE In the event that a sequence of trace points with precisely the same value represent the maximum, the leftmost point is found.

Key Path	Peak Search, More, Peak Criteria
Mode	CMMB
Remote Command	:CALCulate:EVM:MARKer:PEAK:EXCursion <rel_ampl> :CALCulate:EVM:MARKer:PEAK:EXCursion? :CALCulate:EVM:MARKer:PEAK:EXCursion:STATe OFF ON 0 1 :CALCulate:EVM:MARKer:PEAK:EXCursion:STATe?
Example	CALC:EVM:MARK:PEAK:EXC 6.00 CALC:EVM:MARK:PEAK:EXC? CALC:EVM:MARK:PEAK:EXC:STAT ON CALC:EVM:MARK:PEAK:EXC:STAT?
Preset	6.00 ON
State Saved	Saved in instrument state.
Min	0.00
Max	100.00
Initial S/W Revision	A.06.00

Pk Threshold

This key is visible only when current view is ‘Channel Impulse Response’ view.

Turns the peak threshold requirement on/off and sets the threshold value. The peak threshold value defines the minimum signal level (or min threshold) that the peak identification algorithm uses to recognize a peak.

When both ‘Pk Excursion’ and ‘Pk Threshold’ are on, a signal must rise above the Pk Threshold value by at least the Peak Excursion value and then fall back from its local maximum by at least the Peak Excursion value to be considered a peak.

For example, if a threshold value of –90 dB is selected, the peak search algorithm will only consider signals with amplitude greater than the –90 dB threshold. If a threshold value of –90 dB is selected, and Peak Excursion is On and set to 6 dB, the peak search algorithm will only consider signals with amplitude greater than the –90 dB threshold which rise 6 dB above the threshold and then fall back to the threshold.

Key Path	Peak Search, More, Peak Criteria
----------	----------------------------------

Mode	CMMB
Remote Command	:CALCulate:EVM:MARKer:PEAK:THReshold <real> :CALCulate:EVM:MARKer:PEAK:THReshold? :CALCulate:EVM:MARKer:PEAK:THReshold:STATe OFF ON 0 1 :CALCulate:EVM:MARKer:PEAK:THReshold:STATe?
Example	CALC:EVM:MARK:PEAK:THR -90.00 CALC:EVM:MARK:PEAK:THR? CALC:EVM:MARK:PEAK:THR:STAT ON CALC:EVM:MARK:PEAK:THR:STAT?
Couplings	If Peak Threshold is Off and the Peak Threshold line is turned on, it should turn on Peak Threshold. If Peak Threshold Line is On and the Peak Threshold is turned off, it should turn off Peak Threshold Line.
Preset	-90.00 ON
State Saved	Saved in instrument state.
Min	-200.00
Max	0.00
Initial S/W Revision	A.06.00

Pk Threshold Line

This key is visible only when current view is 'Channel Impulse Response' view.

Turns the peak threshold line on or off. Preset state is off. No equivalent SCPI command.

See [“More Information” on page 683](#).

Key Path	Peak Search, More, Peak Criteria
Mode	CMMB
Couplings	If Peak Threshold is Off and the Peak Threshold line is turned on, it should turn on Peak Threshold. If Peak Threshold Line is On and the Peak Threshold is turned off, it should turn off Peak Threshold Line.
Initial S/W Revision	A.06.00

More Information

The Peak Threshold line is green and has the value of the peak threshold (for example, “-60.00 dB”) written above its right side. If Peak Excursion is ON, it shows on the left side as a region above the Peak Threshold line. As with all such lines (Peak Limit Line) it is drawn on top of all traces.

Mod Accuracy Measurement Peak Search

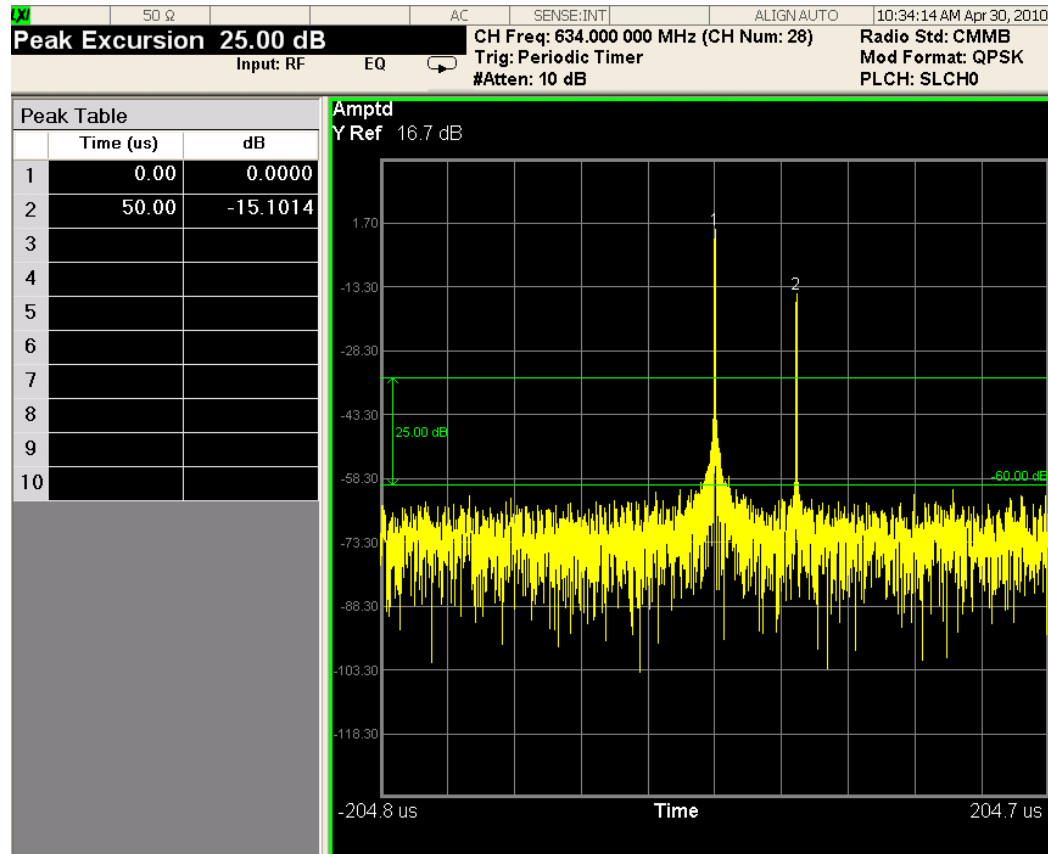

This function is automatically set to OFF whenever Peak Threshold is set to OFF. Manually turning it ON automatically turns on 'Pk Threshold'.

The green line above PK Threshold line and the double arrow-headed line with xx dB on the right indicate the PK Excursion. You can see this information only if both Pk Threshold Line (Peak Search, More, Peak Criteria) and Peak Excursion (Peak Search, More, Peak Criteria) are toggled to On.

Peak Table

This key is visible only when current view is 'Channel Impulse Response' view.

Key Path	Peak Search, More
Initial S/W Revision	A.06.00

The Peak Table provides a displayed list of up to 10 signal peaks from the Amplitude vs. Time trace. If there are more than 10 signals which meet the peak search criteria, only the 10 highest peaks are listed.

The list of peaks in the Peak Table can be ordered either by ascending time (absolute value, delay) or by descending amplitude. In either case, the entire trace is first evaluated and the 10 highest peaks are selected for inclusion in the list. After the peaks are selected, they are then sorted and displayed according to the Peak Sort setting.

When Peak Table is turned on, a new window is created along the left side of the display to accommodate the table. Each entry in the table contains the peak index (1–10), the x-axis value, and the

y-axis value. Each peak index number is also displayed on the trace immediately above the corresponding peak.

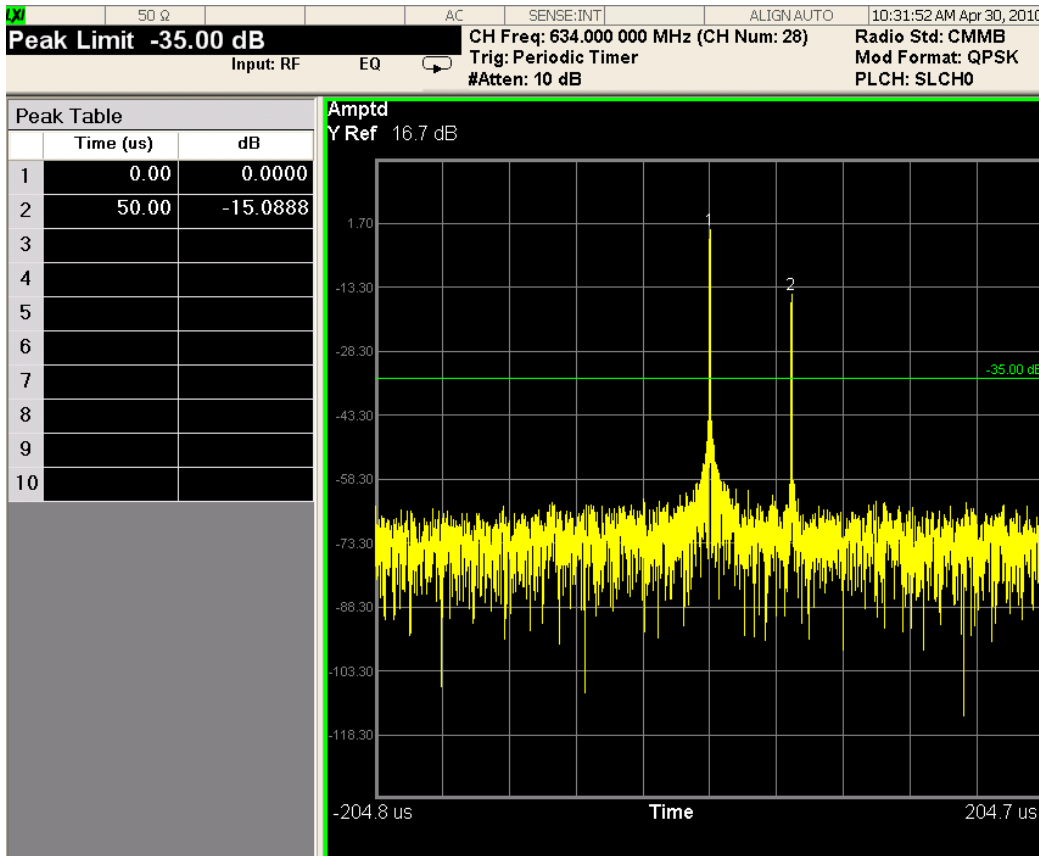

Peak Table

This key is visible only when current view is 'Channel Impulse Response' view.

Turns Peak Table on/off. When turned on, the display is split into a measurement window and a peak table display window.

Key Path	Peak Search, More, Peak Table
Mode	CMMB
Remote Command	:CALCulate:EVM:MARKer:PEAK:TABLE:STATe OFF ON 0 1 :CALCulate:EVM:MARKer:PEAK:TABLE:STATe?
Example	CALC:EVM:MARK:PEAK:TABL:STAT OFF CALC:EVM:MARK:PEAK:TABL:STAT?
Preset	ON
State Saved	Saved in instrument state.
Range	On Off

Mod Accuracy Measurement
Peak Search

Initial S/W Revision	A.06.00
----------------------	---------

Peak Sort

This key is visible only when current view is ‘Channel Impulse Response’ view.

Sets the peak table sorting routine to list the peaks in order of descending amplitude or ascending time (absolute value).

Key Path	Peak Search, More, Peak Table
Mode	CMMB
Remote Command	:CALCulate:EVM:MARKer:PEAK:SORT TIME AMPLitude :CALCulate:EVM:MARKer:PEAK:SORT?
Example	CALC:EVM:MARK:PEAK:SORT AMPLitude CALC:EVM:MARK:PEAK:SORT?
Preset	AMPLitude
State Saved	Saved in instrument state.
Range	Time Amptd
Initial S/W Revision	A.06.00

Peak Limit

This key is visible only when current view is ‘Channel Impulse Response’ view.

If Peak Limit is set to on, a green line will display on Channel Impulse Response view. Only the peaks above Peak Limit will be displayed in Peak Table.

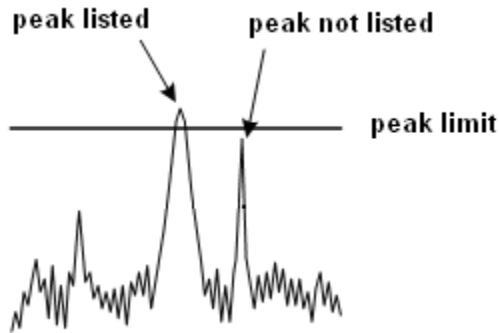

Key Path	Peak Search, More, Peak Table
Mode	CMMB

Remote Command	:CALCulate:EVM:MARKer:PEAK:LIMit <real> :CALCulate:EVM:MARKer:PEAK:LIMit? :CALCulate:EVM:MARKer:PEAK:LIMit:STATe OFF ON 0 1 :CALCulate:EVM:MARKer:PEAK:LIMit:STATe?
Example	CALC:EVM:MARK:PEAK:LIM -35.0 CALC:EVM:MARK:PEAK:LIM? CALC:EVM:MARK:PEAK:LIM:STAT OFF CALC:EVM:MARK:PEAK:LIM:STAT?
Preset	-35.00 ON
State Saved	Saved in instrument state.
Min	-1000.00
Max	500.00
Initial S/W Revision	A.06.00

Pk-Pk Search

Finds and displays the amplitude and frequency (or time, if in zero span) differences between the highest and lowest y-axis value.

Key Path	Peak Search, More
Mode	CMMB
Remote Command	:CALCulate:EVM:MARKer [1] 2 3 4 5 6 7 8 9 10 11 12 :PTPea k
Example	CALC:EVM:MARK:PTP
Notes	Restrictions Information: Turns on the Marker Δ active function.
Couplings	This key is not available (grayed out) when Coupled Markers is on.
Initial S/W Revision	A.03.00

Min Search

Moves the selected marker to the minimum y-axis value on the current trace.

Key Path	Peak Search, More
Mode	CMMB

Mod Accuracy Measurement
Peak Search

Remote Command	:CALCulate:EVM:MARKer[1] 2 3 4 5 6 7 8 9 10 11 12:MINimum
Example	CALC:EVM:MARK:MIN
Initial S/W Revision	A.03.00

Recall

See [“Recall” on page 153](#) in the section "Common Measurement Functions" for more information.

Restart

See “[Restart](#)” on page 1163 in the section "Common Measurement Functions" for more information.

Save

See [“Save” on page 170](#) in the section "Common Measurement Functions" for more information.

Single

See “[Single \(Single Measurement/Sweep\)](#)” on page 1169 in the section "Common Measurement Functions" for more information.

Source

See “[Source](#)” on page 1171 in the section "Common Measurement Functions" for more information.

SPAN X Scale

Sets the desired horizontal scale and associated settings. The settings available vary with each active window.

Key Path	Front-panel key
Initial S/W Revision	A.03.00

Ref Value

Sets the displayed X reference value. The key is active in MER/EVM vs. Sub-carrier/Frequency Window, Amptd vs. Sub-carrier Window, Phase vs. Sub-carrier Window, Group Delay vs. Sub-carrier Window, and Amptd vs. Time Window.

Key Path	Span X Scale
Initial S/W Revision	A.03.00

X Ref Value (I/Q Error View – MER/EVM vs. Sub-carrier/Frequency Window)

This key sets the reference value on the horizontal axis in the MER/EVM vs. Sub-carrier/Frequency window. The displayed value will be updated according to Scale Type (Span X Scale) as follows:

“X Ref Value (Scale Type is ‘Carrier’)” on page 694

“X Ref Value (Scale Type is ‘Freq’)” on page 695

X Ref Value (Scale Type is ‘Carrier’)

If the scale type is set to Carrier, X Ref Value is displayed and set in subcarr.

Key Path	Span X Scale
Mode	CMMB
Remote Command	:DISPlay:EVM:VIEW2:WINDow[1]:TRACe:X[:SCALe][:CARRier]:RLEVel <real> :DISPlay:EVM:VIEW2:WINDow[1]:TRACe:X[:SCALe][:CARRier]:RLEVel?
Example	DISP:EVM:VIEW2:WIND:TRAC:X:RLEV 0.0 DISP:EVM:VIEW2:WIND:TRAC:X:RLEV?
Notes	SCPI Remarks: VIEW2: I/Q Error View WINDow[1]: MER/EVM vs. Sub-carrier/Frequency Window on I/Q Error View

Dependencies	If Auto Scaling is set to On, this value is automatically determined by the measurement result. When you set this value manually, Auto Scaling is automatically set to Off.
Preset	0.0
State Saved	No
Min	-5000.0
Max	5000.0
Initial S/W Revision	A.03.00
Modified at S/W Revision	A.06.00

X Ref Value (Scale Type is 'Freq')

If the scale type is set to Freq, X Ref Value is displayed and set in Hz.

Key Path	Span X Scale
Mode	CMMB
Remote Command	:DISPlay:EVM:VIEW2:WINDow[1]:TRACe:X[:SCALe]:FREQuency:RLEVel <real> :DISPlay:EVM:VIEW2:WINDow[1]:TRACe:X[:SCALe]:FREQuency:RLEVel?
Example	DISP:EVM:VIEW2:WIND:TRAC:X:FREQ:RLEV 0.0 DISP:EVM:VIEW2:WIND:TRAC:X:FREQ:RLEV?
Notes	SCPI Remarks: VIEW2: I/Q Error View WINDow[1]: MER/EVM vs. Sub-carrier/Frequency Window on I/Q Error View
Dependencies	If Auto Scaling is set to On, this value is automatically determined by the measurement result. When you set this value manually, Auto Scaling is automatically set to Off.
Preset	Value is automatically determined by the measurement result with Auto Scaling set to On.
State Saved	No
Min	0.0
Max	3.0e9 Hz
Initial S/W Revision	A.06.00

X Ref Value (Channel Frequency Response View / Spectral Flatness View – Amptd vs. Sub-carrier Window)

Sets the sub-carrier reference value on the horizontal axis in the Amptd vs. Sub-carrier window.

Key Path	Span X Scale
Mode	CMMB
Remote Command	:DISPlay:EVM:VIEW3 5 : WINDow [1] : TRACe:X [: SCALe] : RLEVel <real> :DISPlay:EVM:VIEW3 5 : WINDow [1] : TRACe:X [: SCALe] : RLEVel?
Example	DISP:EVM:VIEW3:WIND:TRAC:X:RLEV 0.0 DISP:EVM:VIEW3:WIND:TRAC:X:RLEV?
Notes	SCPI Remarks: VIEW3: Channel Frequency Response View VIEW5: Spectral Flatness View WINDow[1]: Amptd vs. Sub-carrier Window
Dependencies	If Auto Scaling is set to On, this value is automatically determined by the measurement result. When you set this value manually, Auto Scaling is automatically set to Off.
Preset	0.0
State Saved	No
Min	-5000.0
Max	5000.0
Initial S/W Revision	A.03.00

X Ref Value (Channel Frequency Response View – Phase vs. Sub-carrier Window)

Sets the sub-carrier reference value on the horizontal axis in the Phase vs. Sub-carrier window.

Key Path	Span X Scale
Mode	CMMB
Remote Command	:DISPlay:EVM:VIEW3 : WINDow2 : TRACe:X [: SCALe] : RLEVel <real> :DISPlay:EVM:VIEW3 : WINDow2 : TRACe:X [: SCALe] : RLEVel?
Example	DISP:EVM:VIEW3:WIND2:TRAC:X:RLEV 0.0 DISP:EVM:VIEW3:WIND2:TRAC:X:RLEV?

Notes	SCPI Remarks: VIEW3: Channel Frequency Response View WINDow2: Phase vs. Sub-carrier Window on Channel Frequency Response View
Dependencies	If Auto Scaling is set to On, this value is automatically determined by the measurement result. When you set this value manually, Auto Scaling is automatically set to Off.
Preset	0.0
State Saved	No
Min	-5000.0
Max	5000.0
Initial S/W Revision	A.03.00

X Ref Value (Channel Frequency Response View –Group Delay vs. Sub-carrier Window)

Sets the sub-carrier reference value on the horizontal axis in the Group Delay vs. Sub-carrier window.

Key Path	Span X Scale
Mode	CMMB
Remote Command	:DISPlay:EVM:VIEW3:WINDow3:TRACe:X[:SCALE]:RLEVel <real> :DISPlay:EVM:VIEW3:WINDow3:TRACe:X[:SCALE]:RLEVel?
Example	DISP:EVM:VIEW3:WIND3:TRAC:X:RLEV 0.0 DISP:EVM:VIEW3:WIND3:TRAC:X:RLEV?
Notes	SCPI Remarks: VIEW3: Channel Frequency Response View WINDow3: Group Delay vs. Sub-carrier Window on Channel Frequency Response View
Dependencies	If Auto Scaling is set to On, this value is automatically determined by the measurement result. When you set this value manually, Auto Scaling is automatically set to Off.
Preset	0.0
State Saved	No
Min	-5000.0
Max	5000.0
Initial S/W Revision	A.03.00

X Ref Value (Channel Impulse Response View – Amptd vs. Time Window)

Sets the reference value on the horizontal axis in the Amptd vs. Time window.

Key Path	Span X Scale
Mode	CMMB
Remote Command	:DISPlay:EVM:VIEW4:WINDow[1]:TRACe:X[:SCALe]:RLEVel <real> :DISPlay:EVM:VIEW4:WINDow[1]:TRACe:X[:SCALe]:RLEVel?
Example	DISP:EVM:VIEW4:WIND:TRAC:X:RLEV 0.0 DISP:EVM:VIEW4:WIND:TRAC:X:RLEV?
Notes	SCPI Remarks: VIEW4: Channel Impulse Response View WINDow[1]: Amptd vs. Time Window on Channel Impulse Response View
Dependencies	If Auto Scaling is set to On, this value is automatically determined by the measurement result. When you set this value manually, Auto Scaling is automatically set to Off.
Preset	0.00 s
State Saved	No
Min	-20.0 s
Max	20.0 s
Initial S/W Revision	A.03.00

Scale/Div

Following is for X Scale/Div control. The key is active in MER/EVM vs. Sub-carrier/Frequency Window, Amptd vs. Sub-carrier Window, Phase vs. Sub-carrier Window, Group Delay vs. Sub-carrier Window, and Amptd vs. Time Window.

Key Path	Span X Scale
Initial S/W Revision	A.03.00

X Scale/Div (I/Q Error View – MER/EVM vs. Sub-carrier/ Frequency Window)

This key sets the value per division on the horizontal scale in the MER/EVM vs. Sub-carrier/Frequency window. The displayed value will be updated according to Scale Type (Span X Scale) as follows:

“X Scale/Div (Scale Type is ‘Carrier’) ” on page 699

“X Scale/Div (Scale Type is ‘Freq’)” on page 699

X Scale/Div (Scale Type is 'Carrier')

If the scale type is set to Carrier, X Scale/Div is displayed and set in subcarr.

Key Path	Span X Scale
Mode	CMMB
Remote Command	:DISPlay:EVM:VIEW2:WINDow[1]:TRACe:X[:SCALE]:CARRier:PDIVision <real> :DISPlay:EVM:VIEW2:WINDow[1]:TRACe:X[:SCALE]:CARRier:PDIVision?
Example	DISP:EVM:VIEW2:WIND:TRAC:X:PDIV 84.0 DISP:EVM:VIEW2:WIND:TRAC:X:PDIV?
Notes	SCPI Remarks: VIEW2: I/Q Error View WINDow[1]: MER/EVM vs. Sub-carrier/Frequency Window on I/Q Error View
Dependencies	If Auto Scaling is set to On, this value is automatically determined by the measurement result. When you set this value manually, Auto Scaling is automatically set to Off.
Preset	307.6
State Saved	No
Min	1.0
Max	500.0
Initial S/W Revision	A.03.00
Modified at S/W Revision	A.06.00

X Scale/Div (Scale Type is 'Freq')

If the scale type is set to Freq, X Scale/Div is displayed and set in Hz.

Key Path	Span X Scale
Mode	CMMB
Remote Command	:DISPlay:EVM:VIEW2:WINDow[1]:TRACe:X[:SCALE]:FREQuency:PDIVision <real> :DISPlay:EVM:VIEW2:WINDow[1]:TRACe:X[:SCALE]:FREQuency:PDIVision?
Example	DISP:EVM:VIEW2:WIND:TRAC:X:FREQ:PDIV 84.0 DISP:EVM:VIEW2:WIND:TRAC:X:FREQ:PDIV?

Mod Accuracy Measurement
SPAN X Scale

Notes	SCPI Remarks: VIEW2: I/Q Error View WINDow[1]: MER/EVM vs. Sub-carrier/Frequency Window on I/Q Error View
Dependencies	If Auto Scaling is set to On, this value is automatically determined by the measurement result. When you set this value manually, Auto Scaling is automatically set to Off.
Preset	Value is automatically determined by the measurement result with Auto Scaling set to On. Result depends on current FFT size.
State Saved	No
Min	1.0 Hz
Max	500.0e6 Hz
Initial S/W Revision	A.06.00

X Scale/Div (Channel Frequency Response View / Spectral Flatness View – Amptd vs. Sub-carrier Window)

Sets the sub-carrier value per division on the horizontal scale in the Amptd vs. Sub-carrier window.

Key Path	Span X Scale
Mode	CMMB
Remote Command	:DISPlay:EVM:VIEW3 5 :WINDow [1] :TRACe:X[:SCALE] :PDIVisio n <real> :DISPlay:EVM:VIEW3 5 :WINDow [1] :TRACe:X[:SCALE] :PDIVisio n?
Example	DISP:EVM:VIEW3:WIND:TRAC:X:PDIV 84.0 DISP:EVM:VIEW3:WIND:TRAC:X:PDIV?
Notes	SCPI Remarks: VIEW3: Channel Frequency Response View VIEW5: Spectral Flatness View WINDow[1]: Amptd vs. Sub-carrier Window
Dependencies	If Auto Scaling is set to On, this value is automatically determined by the measurement result. When you set this value manually, Auto Scaling is automatically set to Off.
Preset	307.6
State Saved	No
Min	1.0
Max	500.0

Initial S/W Revision	A.03.00
----------------------	---------

X Scale/Div (Channel Frequency Response View – Phase vs. Sub-carrier Window)

Sets the sub-carrier value per division on the horizontal scale in the Phase vs. Sub-carrier window.

Key Path	Span X Scale
Mode	CMMB
Remote Command	:DISPlay:EVM:VIEW3:WINDow2:TRACe:X[:SCALE]:PDIVision <real> :DISPlay:EVM:VIEW3:WINDow2:TRACe:X[:SCALE]:PDIVision?
Example	DISP:EVM:VIEW3:WIND2:TRAC:X:PDIV 84.0 DISP:EVM:VIEW3:WIND2:TRAC:X:PDIV?
Notes	SCPI Remarks: VIEW3: Channel Frequency Response View WINDow2: Phase vs. Sub-carrier Window on Channel Frequency Response View
Dependencies	If Auto Scaling is set to On, this value is automatically determined by the measurement result. When you set this value manually, Auto Scaling is automatically set to Off.
Preset	307.6
State Saved	No
Min	1.0
Max	500.0
Initial S/W Revision	A.03.00

X Scale/Div (Channel Frequency Response View –Group Delay vs. Sub-carrier Window)

Sets the sub-carrier value per division on the horizontal scale in the Group Delay vs. Sub-carrier window.

Key Path	Span X Scale
Mode	CMMB
Remote Command	:DISPlay:EVM:VIEW3:WINDow3:TRACe:X[:SCALE]:PDIVision <real> :DISPlay:EVM:VIEW3:WINDow3:TRACe:X[:SCALE]:PDIVision?
Example	DISP:EVM:VIEW3:WIND3:TRAC:X:PDIV 84.0 DISP:EVM:VIEW3:WIND3:TRAC:X:PDIV?

Mod Accuracy Measurement
SPAN X Scale

Notes	SCPI Remarks: VIEW3: Channel Frequency Response View WINDow3: Group Delay vs. Sub-carrier Window on Channel Frequency Response View
Dependencies	If Auto Scaling is set to On, this value is automatically determined by the measurement result. When you set this value manually, Auto Scaling is automatically set to Off.
Preset	307.5
State Saved	No
Min	1.0
Max	500.0
Initial S/W Revision	A.03.00

X Scale/Div (Channel Impulse Response View – Amptd vs. Time Window)

Sets the value per division on the horizontal scale in the Amptd vs. Time window.

Key Path	Span X Scale
Mode	CMMB
Remote Command	:DISPlay:EVM:VIEW4:WINDow[1]:TRACe:X[:SCALE]:PDIVision <real> :DISPlay:EVM:VIEW4:WINDow[1]:TRACe:X[:SCALE]:PDIVision?
Example	DISP:EVM:VIEW4:WIND:TRAC:X:PDIV 0.1 DISP:EVM:VIEW4:WIND:TRAC:X:PDIV?
Notes	SCPI Remarks: VIEW4: Channel Impulse Response View WINDow[1]: Amptd vs. Time Window on Channel Impulse Response View
Dependencies	If Auto Scaling is set to On, this value is automatically determined by the measurement result. When you set this value manually, Auto Scaling is automatically set to Off.
Preset	40.95e-6 s
State Saved	No
Min	5.0e-8 s
Max	1.0 s
Initial S/W Revision	A.03.00

Ref Position

Sets the display reference position to Left, Ctr (center), or Right. The key is active in MER/EVM vs. Sub-carrier/Frequency Window, Amptd vs. Sub-carrier Window, Phase vs. Sub-carrier Window, Group Delay vs. Sub-carrier Window, and Amptd vs. Time Window.

Key Path	Span X Scale
Initial S/W Revision	A.03.00

X Ref Position (I/Q Error View – MER/EVM vs. Sub-carrier/Frequency Window)

Sets the X axis reference position in the MER/EVM vs. Sub-carrier/Frequency window.

Key Path	Span X Scale
Mode	CMMB
Remote Command	:DISPlay:EVM:VIEW2:WINDow[1]:TRACe:X[:SCALE]:RPOSition LEFT CENTer RIGHT :DISPlay:EVM:VIEW2:WINDow[1]:TRACe:X[:SCALE]:RPOSition?
Example	DISP:EVM:VIEW2:WIND:TRAC:X:RPOS CENT DISP:EVM:VIEW2:WIND:TRAC:X:RPOS?
Notes	SCPI Remarks: VIEW2: I/Q Error View WINDow[1]: MER/EVM vs. Sub-carrier/Frequency Window on I/Q Error View
Preset	CENT
State Saved	No
Range	Left Ctr Right
Initial S/W Revision	A.03.00

X Ref Position (Channel Frequency Response View / Spectral Flatness View – Amptd vs. Sub-carrier Window)

Sets the X axis reference position in the Amptd vs. Sub-carrier window.

Key Path	Span X Scale
Mode	CMMB
Remote Command	:DISPlay:EVM:VIEW3 5:WINDow[1]:TRACe:X[:SCALE]:RPOSition LEFT CENTer RIGHT :DISPlay:EVM:VIEW3 5:WINDow[1]:TRACe:X[:SCALE]:RPOSition?

Example	DISP:EVM:VIEW3:WIND:TRAC:X:RPOS CENT DISP:EVM:VIEW3:WIND:TRAC:X:RPOS?
Notes	SCPI Remarks: VIEW3: Channel Frequency Response View VIEW5: Spectral Flatness View WINDow[1]: Amptd vs. Sub-carrier Window
Preset	CENT
State Saved	No
Range	Left Ctr Right
Initial S/W Revision	A.03.00

X Ref Position (Channel Frequency Response View – Phase vs. Sub-carrier Window)

Sets the X axis reference position in the Phase vs. Sub-carrier window.

Key Path	Span X Scale
Mode	CMMB
Remote Command	:DISPlay:EVM:VIEW3:WINDow2:TRACe:X[:SCALE]:RPOSition LEFT CENTer RIGHT :DISPlay:EVM:VIEW3:WINDow2:TRACe:X[:SCALE]:RPOSition?
Example	DISP:EVM:VIEW3:WIND2:TRAC:X:RPOS CENT DISP:EVM:VIEW3:WIND2:TRAC:X:RPOS?
Notes	SCPI Remarks: VIEW3: Channel Frequency Response View WINDow2: Phase vs. Sub-carrier Window on Channel Frequency Response View
Preset	CENT
State Saved	No
Range	Left Ctr Right
Initial S/W Revision	A.03.00

X Ref Position (Channel Frequency Response View –Group Delay vs. Sub-carrier Window)

Sets the X axis reference position in the Group Delay vs. Sub-carrier window.

Key Path	Span X Scale
Mode	CMMB

Remote Command	:DISPlay:EVM:VIEW3:WINDow3:TRACe:X[:SCALE]:RPOStion LEFT CENTer RIGHT :DISPlay:EVM:VIEW3:WINDow3:TRACe:X[:SCALE]:RPOStion?
Example	DISP:EVM:VIEW3:WIND3:TRAC:X:RPOS CENT DISP:EVM:VIEW3:WIND3:TRAC:X:RPOS?
Notes	SCPI Remarks: VIEW3: Channel Frequency Response View WINDow3: Group Delay vs. Sub-carrier Window on Channel Frequency Response View
Preset	CENT
State Saved	No
Range	Left Ctr Right
Initial S/W Revision	A.03.00

X Ref Position (Channel Impulse Response View – Amptd vs. Time Window)

Sets the X axis reference position in the Amptd vs. Time window.

Key Path	Span X Scale
Mode	CMMB
Remote Command	:DISPlay:EVM:VIEW4:WINDow[1]:TRACe:X[:SCALE]:RPOStion LEFT CENTer RIGHT :DISPlay:EVM:VIEW4:WINDow[1]:TRACe:X[:SCALE]:RPOStion?
Example	DISP:EVM:VIEW4:WIND:TRAC:X:RPOS CENT DISP:EVM:VIEW4:WIND:TRAC:X:RPOS?
Notes	SCPI Remarks: VIEW4: Channel Impulse Response View WINDow[1]: Amptd vs. Time Window on Channel Impulse Response View
Preset	CENT
State Saved	No
Range	Left Ctr Right
Initial S/W Revision	A.03.00

Auto Scaling

Toggles the scale coupling function between On and Off. The key is active in MER/EVM vs. Sub-carrier/Frequency Window, Amptd vs. Sub-carrier Window, Phase vs. Sub-carrier Window, Group

Mod Accuracy Measurement
SPAN X Scale

Delay vs. Sub-carrier Window, and Amptd vs. Time Window.

Key Path	Span X Scale
Initial S/W Revision	A.03.00

X Auto Scaling (I/Q Error View – MER/EVM vs. Sub-carrier/Frequency Window)

When Auto Scaling is On, the reference value and scale per division are automatically adjusted in the MER/EVM vs. Sub-carrier/Frequency window.

Key Path	Span X Scale
Mode	CMMB
Remote Command	:DISPlay:EVM:VIEW2:WINDow[1]:TRACe:X[:SCALE]:COUPle OFF ON 0 1 :DISPlay:EVM:VIEW2:WINDow[1]:TRACe:X[:SCALE]:COUPle?
Example	DISP:EVM:VIEW2:WIND:TRAC:X:COUP ON DISP:EVM:VIEW2:WIND:TRAC:X:COUP?
Notes	SCPI Remarks: VIEW2: I/Q Error View WINDow[1]: MER/EVM vs. Sub-carrier/Frequency Window on I/Q Error View
Dependencies	When this parameter is set to On, it will activate the scale coupling function that automatically determines scale per division and reference values based on the measurement results. When you set a value to either Scale/Div or Ref Value manually, Auto Scaling is automatically set to Off.
Preset	ON
State Saved	No
Range	On Off
Initial S/W Revision	A.03.00

X Auto Scaling (Channel Frequency Response View / Spectral Flatness View – Amptd vs. Sub-carrier Window)

When Auto Scaling is On, the reference value and scale per division are automatically adjusted in the Amptd vs. Sub-carrier window.

Key Path	Span X Scale
Mode	CMMB
Remote Command	:DISPlay:EVM:VIEW3 5:WINDow[1]:TRACe:X[:SCALE]:COUPle OFF ON 0 1 :DISPlay:EVM:VIEW3 5:WINDow[1]:TRACe:X[:SCALE]:COUPle?

Example	DISP:EVM:VIEW3:WIND:TRAC:X:COUP ON DISP:EVM:VIEW3:WIND:TRAC:X:COUP?
Notes	SCPI Remarks: VIEW3: Channel Frequency Response View VIEW5: Spectral Flatness View WINDow[1]: Amptd vs. Sub-carrier Window
Dependencies	When this parameter is set to On, it will activate the scale coupling function that automatically determines scale per division and reference values based on the measurement results. When you set a value to either Scale/Div or Ref Value manually, Auto Scaling is automatically set to Off.
Preset	ON
State Saved	No
Range	On Off
Initial S/W Revision	A.03.00

X Auto Scaling (Channel Frequency Response View – Phase vs. Sub-carrier Window)

When Auto Scaling is On, the reference value and scale per division are automatically adjusted in the Phase vs. Sub-carrier window.

Key Path	Span X Scale
Mode	CMMB
Remote Command	:DISPlay:EVM:VIEW3:WINDow2:TRACe:X[:SCALE]:COUPle OFF ON 0 1 :DISPlay:EVM:VIEW3:WINDow2:TRACe:X[:SCALE]:COUPle?
Example	DISP:EVM:VIEW3:WIND2:TRAC:X:COUP ON DISP:EVM:VIEW3:WIND2:TRAC:X:COUP?
Notes	SCPI Remarks: VIEW3: Channel Frequency Response View WINDow2: Phase vs. Sub-carrier Window on Channel Frequency Response View
Dependencies	When this parameter is set to On, it will activate the scale coupling function that automatically determines scale per division and reference values based on the measurement results. When you set a value to either Scale/Div or Ref Value manually, Auto Scaling is automatically set to Off.
Preset	ON
State Saved	No
Range	On Off

Initial S/W Revision	A.03.00
----------------------	---------

X Auto Scaling (Channel Frequency Response View –Group Delay vs. Sub-carrier Window)

When Auto Scaling is On, the reference value and scale per division are automatically adjusted in the Group Delay vs. Sub-carrier window.

Key Path	Span X Scale
Mode	CMMB
Remote Command	:DISP:lay:EVM:VIEW3:WINDow3:TRACe:X[:SCALe]:COUPle OFF ON 0 1 :DISP:lay:EVM:VIEW3:WINDow3:TRACe:X[:SCALe]:COUPle?
Example	DISP:EVM:VIEW3:WIND3:TRAC:X:COUP ON DISP:EVM:VIEW3:WIND3:TRAC:X:COUP?
Notes	SCPI Remarks: VIEW3: Channel Frequency Response View WINDow3: Group Delay vs. Sub-carrier Window on Channel Frequency Response View
Dependencies	When this parameter is set to On, it will activate the scale coupling function that automatically determines scale per division and reference values based on the measurement results. When you set a value to either Scale/Div or Ref Value manually, Auto Scaling is automatically set to Off.
Preset	ON
State Saved	No
Range	On Off
Initial S/W Revision	A.03.00

X Auto Scaling (Channel Impulse Response View – Amptd vs. Time Window)

When Auto Scaling is On, the reference value and scale per division are automatically adjusted in the Amptd vs. Time window.

Key Path	Span X Scale
Mode	CMMB
Remote Command	:DISP:lay:EVM:VIEW4:WINDow[1]:TRACe:X[:SCALe]:COUPle OFF ON 0 1 :DISP:lay:EVM:VIEW4:WINDow[1]:TRACe:X[:SCALe]:COUPle?
Example	DISP:EVM:VIEW4:WIND:TRAC:X:COUP ON DISP:EVM:VIEW4:WIND:TRAC:X:COUP?

Notes	SCPI Remarks: VIEW4: Channel Impulse Response View WINDow[1]: Amptd vs. Time Window on Channel Impulse Response View
Dependencies	When this parameter is set to On, it will activate the scale coupling function that automatically determines scale per division and reference values based on the measurement results. When you set a value to either Scale/Div or Ref Value manually, Auto Scaling is automatically set to Off.
Preset	ON
State Saved	No
Range	On Off
Initial S/W Revision	A.03.00

Scale Type

Set X Scale Type. This key is visible only when the current window is MER/EVM vs. Sub-carrier/Frequency window. If it is set to 'Carrier', the X scale displays the carrier value. If it is set to 'Freq', the X scale displays the frequency value.

Key Path	Span X Scale
Mode	CMMB
Remote Command	:DISPlay:EVM:VIEW2:WINDow[1]:TRACe:X[:SCALE]:TYPE CARRier FREQuency :DISPlay:EVM:VIEW2:WINDow[1]:TRACe:X[:SCALE]:TYPE?
Example	DISP:EVM:VIEW2:WIND:TRAC:X:TYPE CARR DISP:EVM:VIEW2:WIND:TRAC:X:TYPE?
Preset	CARRier
State Saved	No
Range	Carrier Freq
Initial S/W Revision	A.06.00

Sweep/Control

See “[Sweep/Control](#)” on page 1181 in the section "Common Measurement Functions" for more information.

Trace/Detector

There is no trace/detector functionality for this measurement.

Key Path	Front-panel key
Initial S/W Revision	A.03.00

Trigger

See “[Trigger](#)” on page 1251 in the section "Common Measurement Functions" for more information.

View/Display

The View/Display key opens up the View/Display menu for current measurement. The views that are available are specific to the current measurement selected under the **Meas** key.

The CMMB Modulation Accuracy measurement consists of seven views. The default view is I/Q Measured Polar Graph (left/right). For the selection of each view, you can refer to “View Selection” on page 713.

NO	View	NO. of Windows	Window No.	Window
1	VIEW[1] I/Q Measured Polar Graph	Dual (Horizontal)	WINDow[1]	Result Metrics
			WINDow2	I/Q Measured Polar Graph
2	VIEW2 I/Q Error	Quad	WINDow[1]	MER/EVM vs. Sub-carrier/Frequency
			WINDow2	Logical Channel
			WINDow3	Polar Graph
			WINDow4	Result Metrics
3	VIEW3 Channel Frequency Response	Triple (Vertical)	WINDow[1]	Amptd vs. Sub-carrier
			WINDow2	Phase vs. Sub-carrier
			WINDow3	Group Delay vs. Sub-carrier
4	VIEW4 Channel Impulse Response	Single	WINDow[1]	Amptd vs. Time
5	VIEW5 Spectral Flatness	Dual (Vertical)	WINDow[1]	Amptd vs. Sub-carrier
			WINDow2	Result Metrics
6	VIEW6 MER vs. Timeslot	Single	WINDow[1]	MER vs. Timeslot
7	VIEW7 Result Metrics	Single	WINDow[1]	Result Metrics Summary

View Selection

Selects the desired measurement view from the following selections:

- I/Q Measured Polar Graph.
- I/Q Error (quad view). Provides a combination view of MER/EVM vs. Sub-carrier/Frequency graph, Logical Channel graph, Polar Graph, and the result metrics.

Mod Accuracy Measurement
View/Display

- Channel Frequency Response (triple view). Provides a combination view of Amptd vs. Sub-carrier graph, Phase vs. Sub-carrier graph and Group Delay vs. Sub-carrier graph.
- Channel Impulse Response.
- Spectral Flatness.
- MER vs. Timeslot
- Result Metrics.

Key Path	View/Display
Mode	CMMB
Remote Command	:DISPlay:EVM:VIEW[:SElect] POLar IQERror FREQuency IMPulse FLATness MERTimeslot NR ESults :DISPlay:EVM:VIEW[:SElect] ?
Example	DISP:EVM:VIEW POL DISP:EVM:VIEW?
Preset	POLar
State Saved	Saved in instrument state.
Range	I/Q Measured Polar Graph I/Q Error (Quad View) Channel Frequency Response Channel Impulse Response Spectral Flatness MER vs. Timeslot Result Metrics
Initial S/W Revision	A.03.00

Key Path	Front-panel key
Initial S/W Revision	A.03.00

Display

Accesses a menu of functions to set the display parameters.

See [“Display” on page 1313](#) in the section "Common Measurement Functions" for more information.

I/Q Measured Polar Graph

Selects the Polar Graph view, and modifies the display settings of polar graph.

There are two windows, [“Result Metrics Window” on page 715](#) (left) and [“I/Q Measured Polar Graph Window” on page 716](#) (right).

NOTE In Polar Graph window, the blue points are data points, the white points are scattered pilot points, and the green points are continued pilot points.

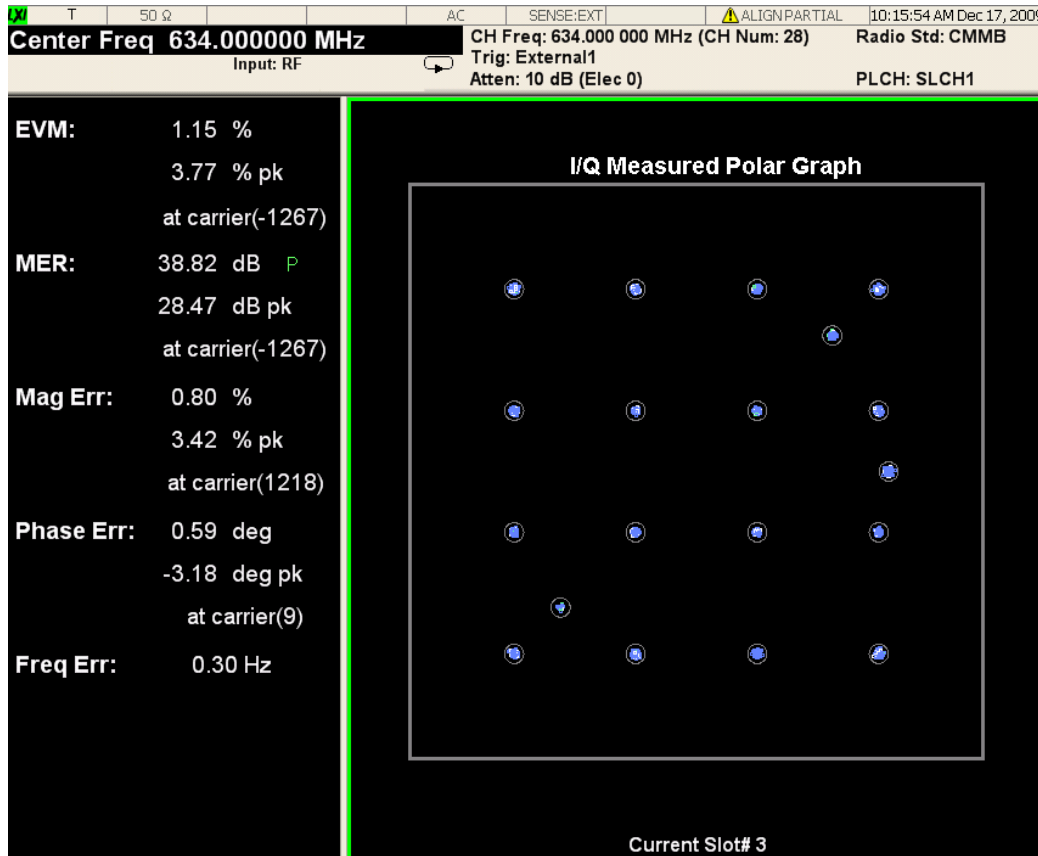

Result Metrics Window

Modulation Accuracy Result Metrics are listed in the following table.

Name	Corresponding Results	Format
EVM	n=1 1st EVM of the current symbols	99.99 %
Peak EVM	n=1 2nd Peak EVM of the current symbols	99.99 % pk
Peak EVM Position	n=1 3rd Sub-carrier number corresponding to the position of peak EVM is returned	at carrier (9999)
MER	n=1 4th MER of the current symbols	99.99 dB
Peak MER	n=1 5th Peak MER of the current symbols	99.99 dB pk

Name	Corresponding Results	Format
Peak MER Position	n=1 6th Sub-carrier number corresponding to the position of peak MER is returned	at carrier (9999)
Mag Err	n=1 7th Magnitude error of the current symbols	99.99 %
Peak Mag Err	n=1 8th Peak magnitude error of the current symbols	99.99 % pk
Peak Mag Err Position	n=1 9th Sub-carrier number corresponding to the position of peak magnitude error is returned	at carrier (9999)
Phase Err	n=1 10th Phase error of the current symbols	99.99 deg
Peak Phase Err	n=1 11th Peak phase error of the current symbols	99.99 deg pk
Peak Phase Err Position	n=1 12th Sub-carrier number corresponding to the position of peak phase error is returned	at carrier (9999)
Freq Err	n=1 13th Frequency error of the current symbols	99.99 Hz

I/Q Measured Polar Graph Window

This window provides IQ polar graph.

Name	Corresponding Trace	Format
Constellation	The I/Q polar trace of measured input data. The length displayed is defined by I/Q Points.(n=2)	Constellation

Key Path	View/Display
Example	:DISPlay:EVM:VIEW POLar :DISPlay:EVM:VIEW?
Initial S/W Revision	A.03.00

Start Carrier

Sets the start carrier number. The constellation points between the start and stop carriers will be

displayed on I/Q Measured polar graph window.

Key Path	View/Display, I/Q Measured Polar Graph
Mode	CMMB
Remote Command	:DISPlay:EVM:CARRier:STARt <integer> :DISPlay:EVM:CARRier:STARt?
Example	DISP:EVM:CARR:STAR 0 DISP:EVM:CARR:STAR?
Notes	Meaning of the numeric values: Number of start carrier on I/Q Measured Polar Graph.
Preset	-1538
State Saved	Saved in instrument state.
Min	-1538
Max	1538
Initial S/W Revision	A.03.00

Stop Carrier

Sets the stop carrier number. The constellation points between the start and stop carriers will be displayed on I/Q Measured polar graph window.

Key Path	View/Display, I/Q Measured Polar Graph
Mode	CMMB
Remote Command	:DISPlay:EVM:CARRier:STOP <integer> :DISPlay:EVM:CARRier:STOP?
Example	DISP:EVM:CARR:STOP 0 DISP:EVM:CARR:STOP?
Notes	Meaning of the numeric values: Number of stop carrier on I/Q Measured Polar Graph.
Preset	1538
State Saved	Saved in instrument state.
Min	Start Carrier
Max	1538
Initial S/W Revision	A.03.00

Timeslot Index

Sets timeslot index. The constellation points of the selected timeslot will be displayed on I/Q Measured polar graph window.

In Free Run mode, this key is grayed out. The constellation points of the current timeslot will be displayed.

If Meas Type (Meas Setup) is 'Frame', this key is not used (grayed out). The combined constellation (including all the modulation formats in a frame, but not all the timeslots) will be displayed.

Key Path	View/Display, I/Q Measured Polar Graph
Mode	CMMB
Remote Command	:DISPlay:EVM:TS:INDex <integer> :DISPlay:EVM:TS:INDex?
Example	DISP:EVM:TS:IND 1 DISP:EVM:TS:IND?
Couplings	If Trigger is 'Free Run' or Meas Type (Meas Setup) is 'Frame', this key is grayed out.
Preset	1
State Saved	Saved in instrument state.
Min	The min timeslot index in the measured timeslot interval.
Max	The max timeslot index in the measured timeslot interval.
Initial S/W Revision	A.06.00

I/Q Error

Selects the I/Q Error view.

There are four windows in this view:

- “MER/EVM vs. Sub-carrier/Frequency Window” on page 719(top left)
- “Logical Channel Window” on page 722 (top right)
- “Polar Graph Window” on page 722 (bottom left)
- “Result Metrics Window” on page 722 (bottom right)

The Reference Value, Units per Division, and Reference Position of X or Y Axis in the trace graph can be adjusted by selecting SPAN X Scale or AMPTD Y Scale.

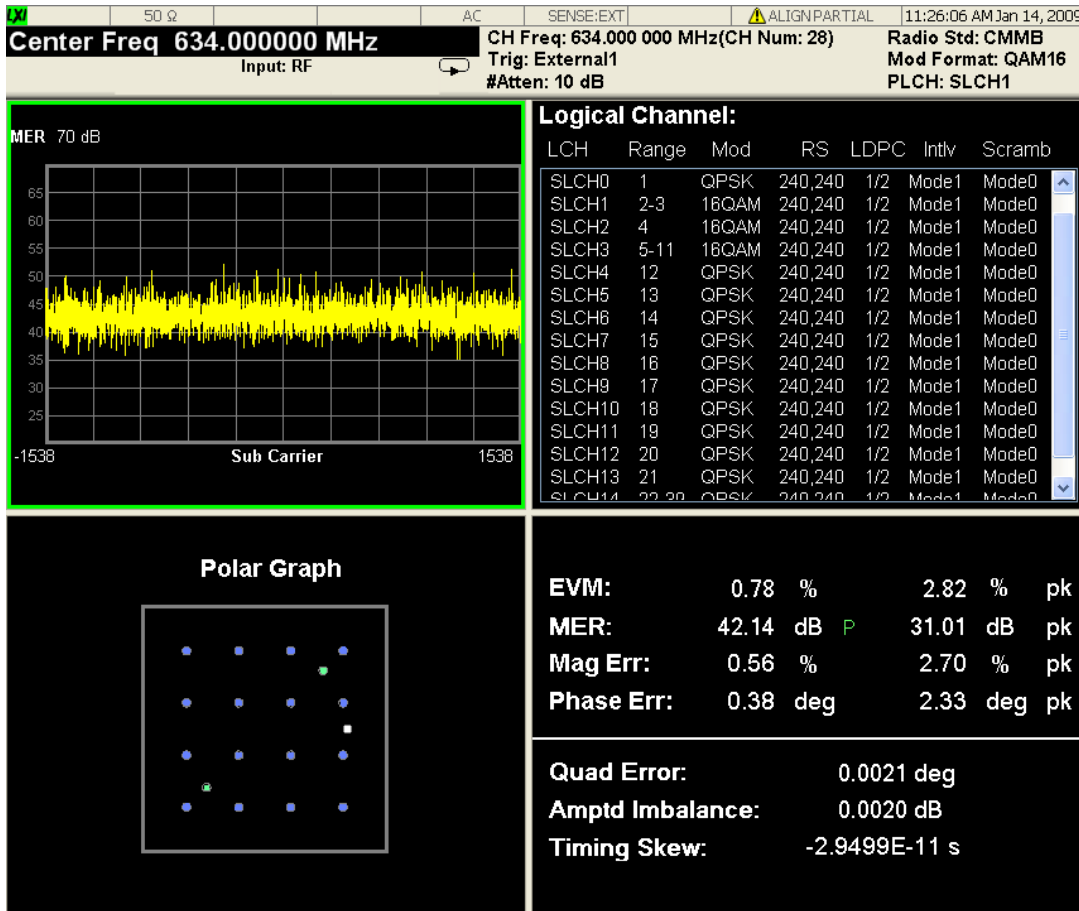

MER/EVM vs. Sub-carrier/Frequency Window

This window provides MER/EVM vs. Sub-carrier/Frequency results. It comprises the MER/EVM value of each sub-carrier/frequency in order to give the users a panorama of MER/EVM results. There are 3077 points in 8MHz mode.

Marker Trace	Yes
Corresponding Trace	MER/EVM vs. Sub-carrier/Frequency trace (n=3)

The top left window will be changed by Y Scale Type and X Scale Type.

If Y Scale Type is 'MER' and X Scale Type is 'Carrier',

Mod Accuracy Measurement
View/Display

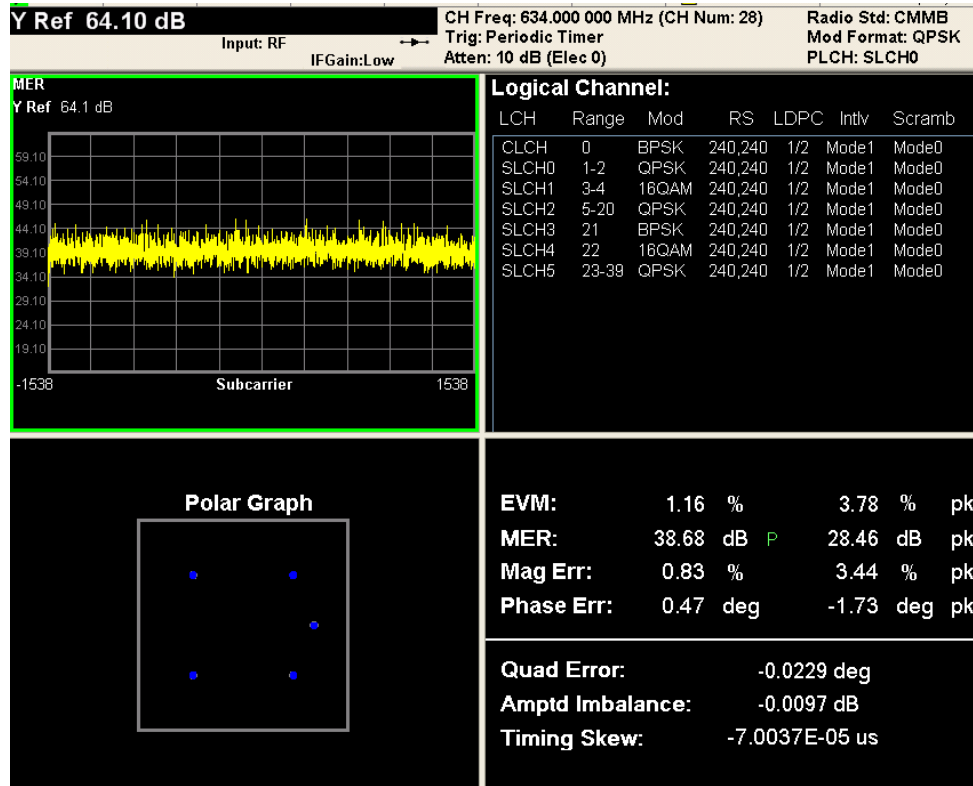

If Y Scale Type is 'EVM' and X Scale Type is 'Carrier',

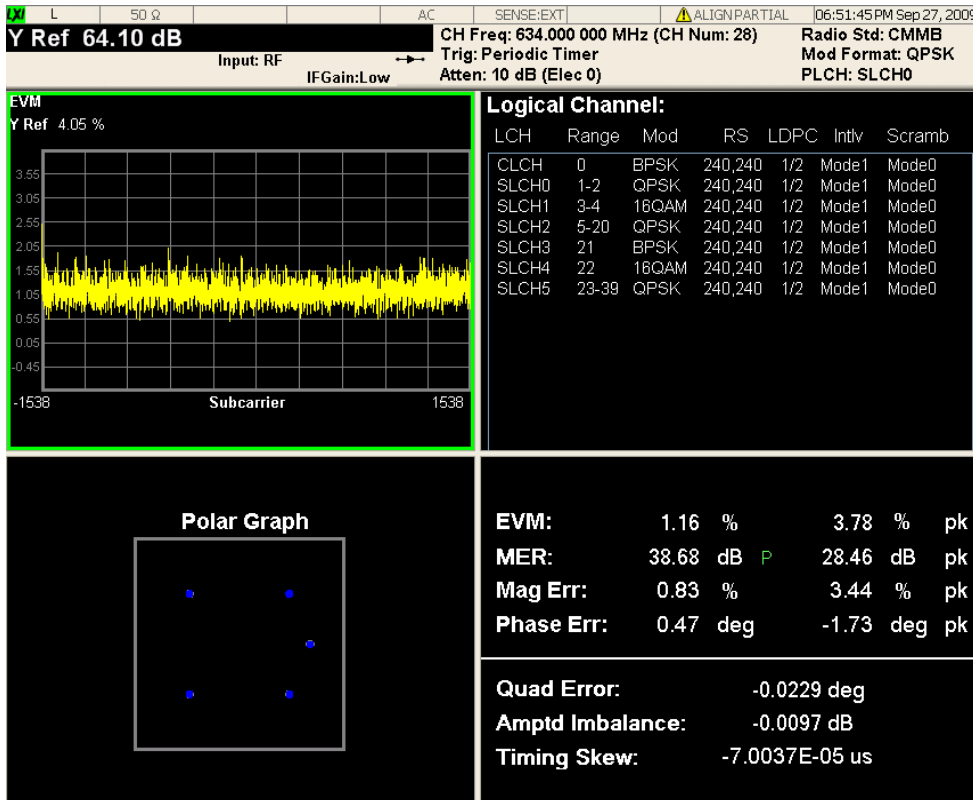

If Y Scale Type is 'MER' and X Scale Type is 'Freq',

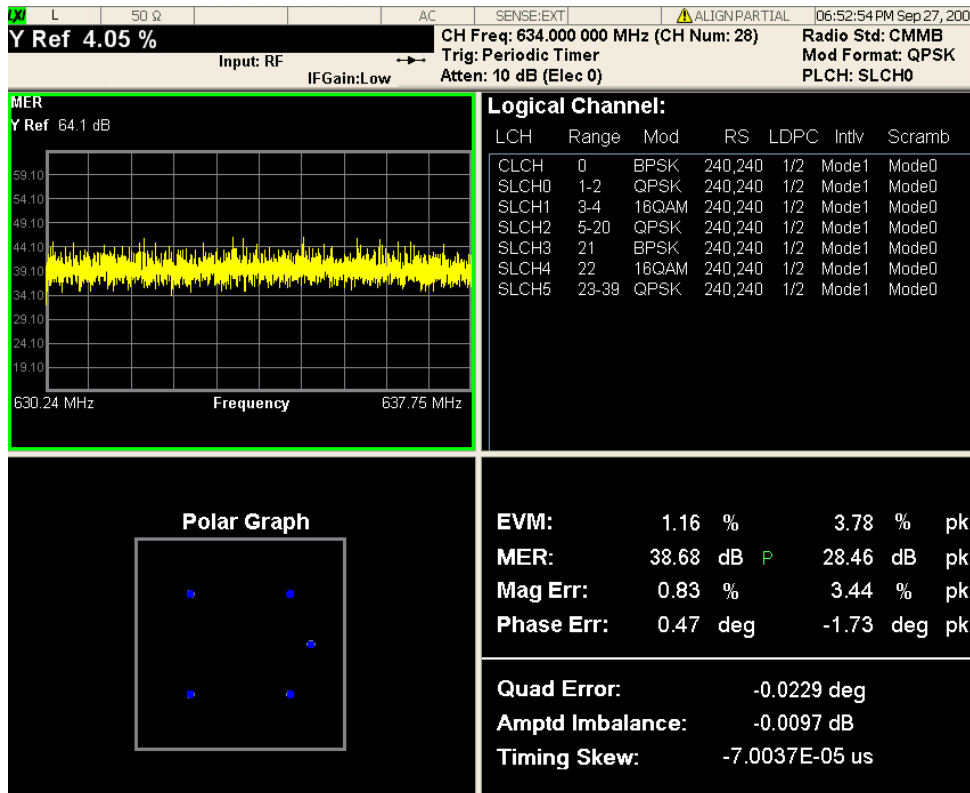

If Y Scale Type is 'EVM' and X Scale Type is 'Freq',

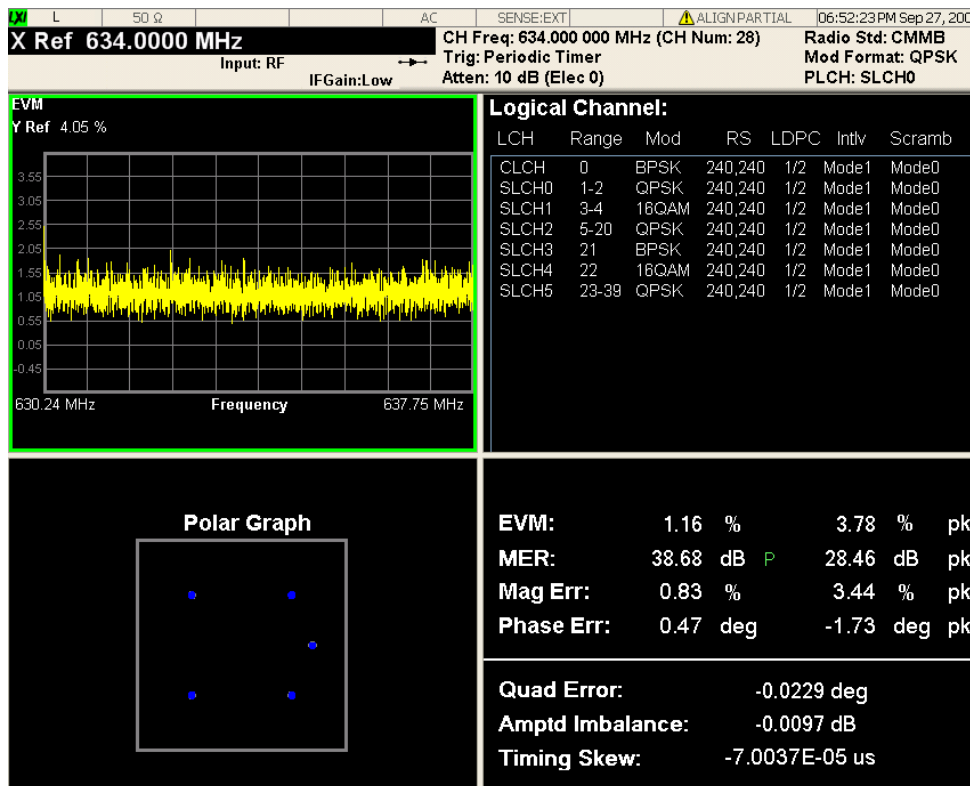

Logical Channel Window

This window provides Logical Channel graph. It gives the TS0 decoding results.

Name	Corresponding Results	Format
LCH	Physical Logical Channel (PLCH) type and index. PLCH includes one Control Logical Channel (CLCH) and multiple Service Logical Channels (SLCH).	
Range	Start timeslot and end timeslot for corresponding PLCH	
Mod	Modulation format for corresponding PLCH	BPSK, QPSK, 16QAM
RS	RS code rate for corresponding PLCH	(240, 240), (240, 224), (240,192), (240, 176)
LDPC	LDPC code rate for corresponding PLCH	1/2, 3/4
Intlv	Byte interleaving type for corresponding PLCH	Mode 1, Mode 2, Mode 3
Scramb	Scrambling type for corresponding PLCH	Mode 0, Mode 1, Mode 2, Mode 3, Mode 4, Mode 5, Mode 6, Mode 7

Polar Graph Window

This window provides Polar Graph.

Name	Corresponding Trace	Format
Constellation	The I/Q polar trace of measured input data. The length displayed is defined by I/Q Points.(n=2)	Constellation

Result Metrics Window

This window provides Modulation Accuracy result metrics.

Name	Corresponding Results	Format
EVM	n=1 1st EVM of the current symbols	99.99 %
Peak EVM	n=1 2nd Peak EVM of the current symbols	99.99 %
MER	n=1 4th MER of the current symbols	99.99 dB
Peak MER	n=1 5th Peak MER of the current symbols	99.99 dB

Name	Corresponding Results	Format
Mag Error	n=1 7th Mag Error of the current symbols	99.99 %
Peak Mag Error	n=1 8th Peak Mag Error of the current symbols	99.99 %
Phase Error	n=1 10th Phase Error of the current symbols	99.99 deg
Peak Phase Error	n=1 11th Peak Phase Error of the current symbols	99.99 deg
Amptd Imbalance	n=1 14th Amplitude imbalance of the current symbols	99.9999 dB
Quad Err	n=1 15th Quadrature error of the current symbols	99.9999 deg
Timing Skew	n=1 16th Timing skew of the current symbols	9.9999E9 s

Key Path	View/Display
Example	:DISPlay:EVM:VIEW IQERror :DISPlay:EVM:VIEW?
Initial S/W Revision	A.03.00

Prev Page

Moves the display one page back to the previous page of the Logical Channel window.

Key Path	View/Display, I/Q Error
Mode	CMMB
Initial S/W Revision	A.03.00

Next Page

Moves the display one page forward to the next page of the Logical Channel window.

Key Path	View/Display, I/Q Error
Mode	CMMB
Initial S/W Revision	A.03.00

Scroll Up

Moves one line upward from the current line of the Logical Channel window.

Pressing the up arrow hard key has the same effect as this function, if no active function is shown. If an active function is shown, the up arrow hard key controls the active function, but has no effect on line movement.

Key Path	View/Display, I/Q Error
Mode	CMMB
Initial S/W Revision	A.03.00

Scroll Down

Moves one line downward from the current line of the Logical Channel window.

Pressing the down arrow hard key has the same effect as this function, if no active function is shown. If an active function is shown, the down arrow hard key controls the active function, but has no effect on line movement.

Key Path	View/Display, I/Q Error
Mode	CMMB
Initial S/W Revision	A.03.00

First Page

Moves the display to the first page of the Logical Channel window.

Key Path	View/Display, I/Q Error
Mode	CMMB
Initial S/W Revision	A.03.00

Last Page

Moves the display to the last page of the Logical Channel window.

Key Path	View/Display, I/Q Error
Mode	CMMB
Initial S/W Revision	A.03.00

Channel Frequency Response

Selects the channel frequency response view.

There are three windows in this view:

- [“Amplitude vs. Sub-carrier Window” on page 725](#) (Top)

- “Phase vs. Sub-carrier Window” on page 725 (Center)
- “Group delay vs. Sub-carrier Window” on page 726 (Bottom)

The Reference Value, Units per Division, and Reference Position of X or Y Axis in the trace graph can be adjusted by selecting SPAN X Scale or AMPTD Y Scale.

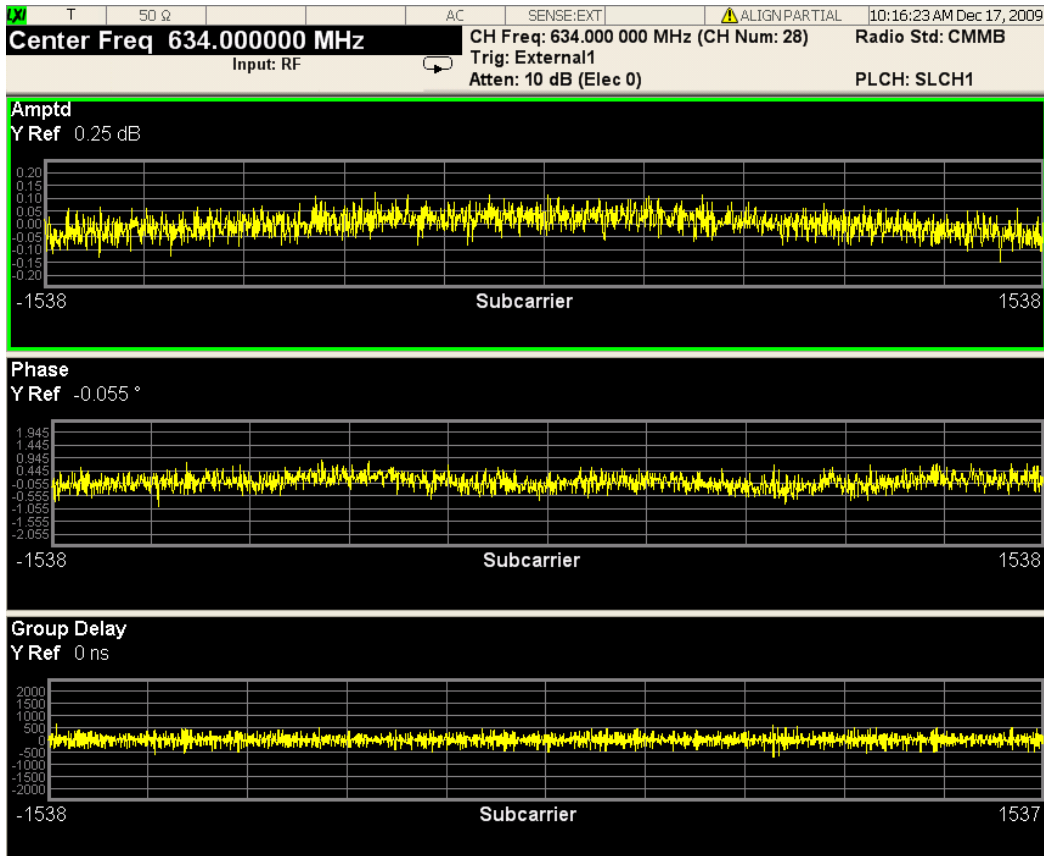

Amplitude vs. Sub-carrier Window

This window provides amplitude vs. sub-carrier results.

Marker Trace	Yes
Corresponding Trace	Amplitude vs. Sub-carrier trace (n=4).

Phase vs. Sub-carrier Window

This window provides phase vs. sub-carrier results.

Marker Trace	Yes
Corresponding Trace	Phase vs. Sub-carrier trace (n=5).

Group delay vs. Sub-carrier Window

This window provides group delay vs. sub-carrier results.

Marker Trace	Yes
Corresponding Trace	Group delay vs. Sub-carrier trace (n=6).

Key Path	View/Display
Example	:DISPlay:EVM:VIEW FREQuency :DISPlay:EVM:VIEW?
Initial S/W Revision	A.03.00

Channel Impulse Response

Selects the channel impulse response view.

There are two windows, Peak Table (left) and [“Amplitude vs. time window” on page 726](#) (right). For more information, refer to Section [“Peak Table” on page 684](#).

Amplitude vs. time window

Marker Trace	Yes
Corresponding Trace	Amplitude vs. Time trace (n=7).

The Reference Value, Units per Division, and Reference Position of X or Y Axis in this graph can be adjusted by selecting SPAN X Scale or AMPTD Y Scale.

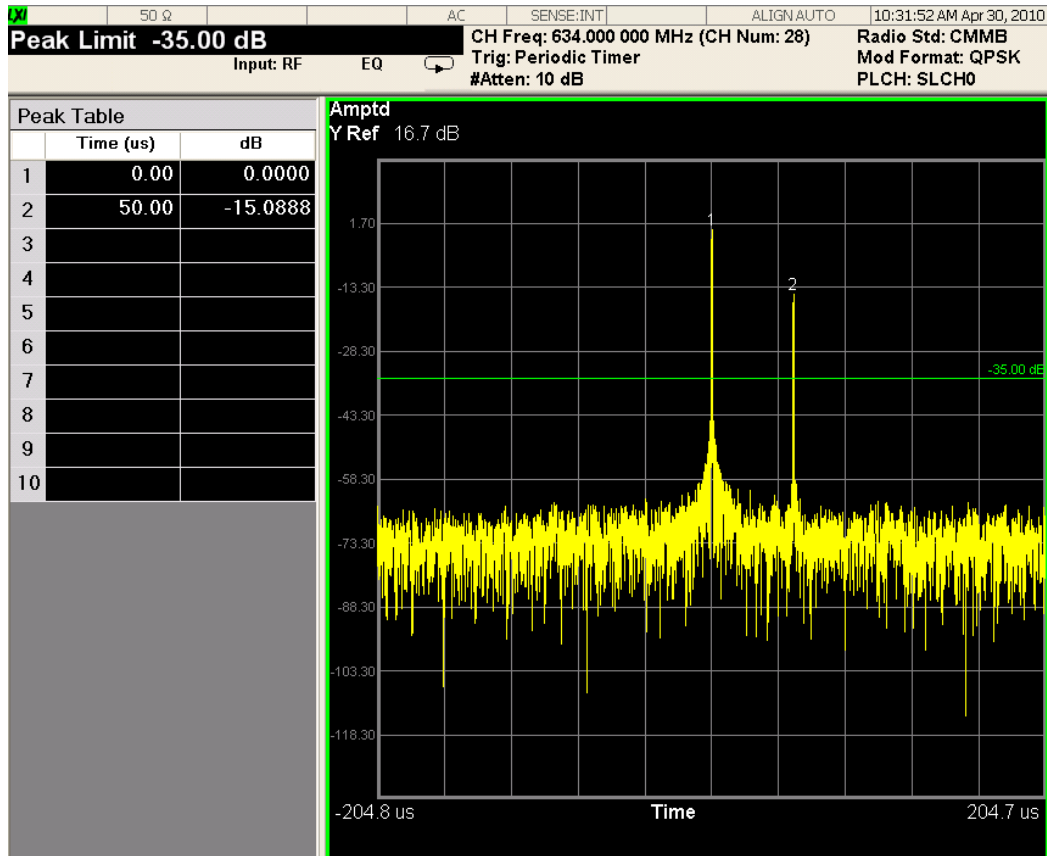

Key Path	View/Display
Example	:DISPlay:EVM:VIEW IMPulse :DISPlay:EVM:VIEW?
Initial S/W Revision	A.03.00

CP Range Bar

Turns this bar On and Off. If the value is 'On', there will be a bar from -CP (Cyclic Prefix) to CP displayed on Channel Impulse Response view.

Key Path	View/Display, Channel Impulse Response
Mode	CMMB
Remote Command	:DISPlay:EVM:CPRBar [:STATe] OFF ON 0 1 :DISPlay:EVM:CPRBar [:STATe] ?
Example	DISP:EVM:CPRB OFF DISP:EVM:CPRB?
Preset	OFF

State Saved	Saved in instrument state.
Range	On Off
Initial S/W Revision	A.06.00

Spectral Flatness

Selects the Spectral Flatness view. There are two windows:

1. “Amplitude vs. Sub-carrier Window” on page 728 (top)
2. “Result Metrics Window” on page 729 (bottom)

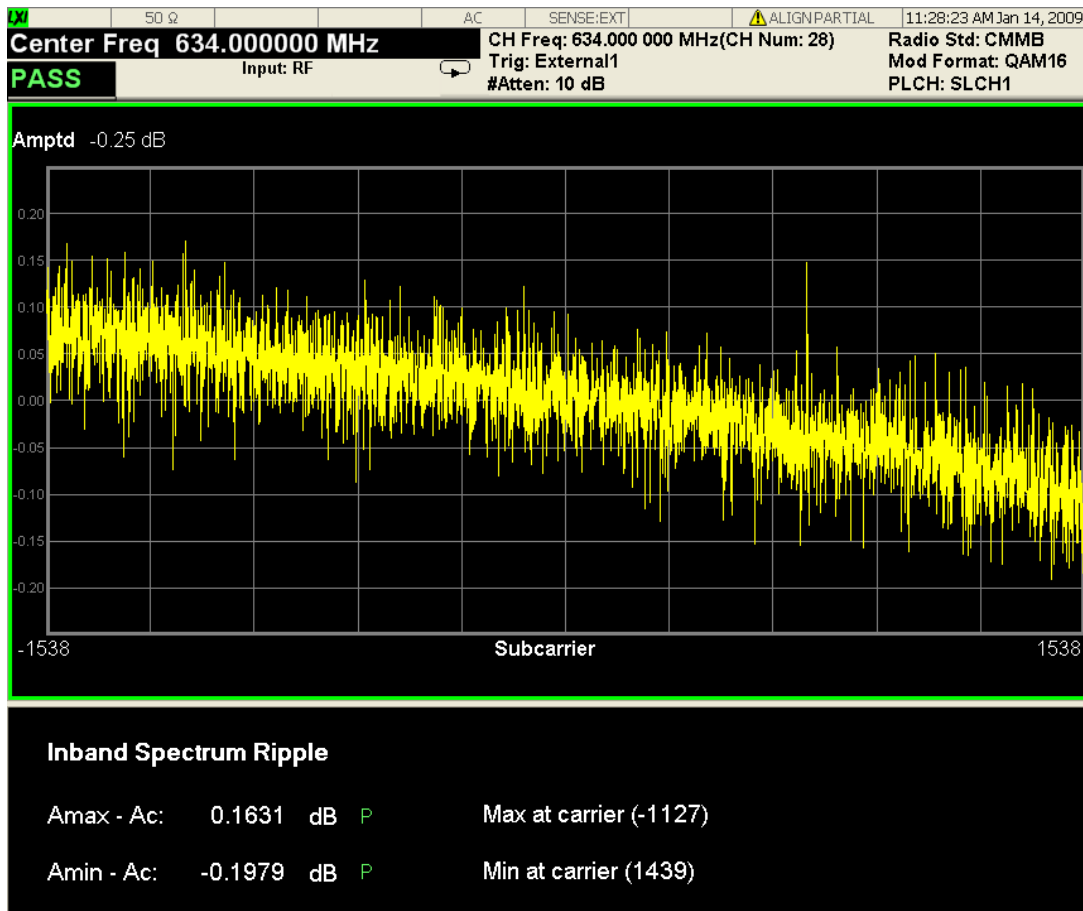

Amplitude vs. Sub-carrier Window

This window provides amplitude vs. sub-carrier results.

Marker Trace	Yes
Corresponding Trace	Amplitude vs. Sub-carrier trace (n=4).

Result Metrics Window

This window provides Modulation Accuracy result metrics.

Name	Corresponding Results	Format
Max to CF	n=1 17th The difference between Max Amplitude Inband and Amplitude at Center Frequency point	99.99 dB
Max Amplitude Inband Position	n=1 18th Position of Max Amplitude Inband	at carrier (9999)
Min to CF	n=1 19th The difference between Min Amplitude Inband and Amplitude at Center Frequency point	99.99 dB
Min Amplitude Inband Position	n=1 20th Position of Min Amplitude Inband	at carrier (9999)

Key Path	View/Display
Example	:DISPlay:EVM:VIEW FLATness :DISPlay:EVM:VIEW?
Initial S/W Revision	A.03.00

MER vs. Timeslot Graph

Selects the MER vs. Timeslot view.

There is one window, “[MER vs. Timeslot window](#)” on page 730, which shows the MER vs. timeslot results.

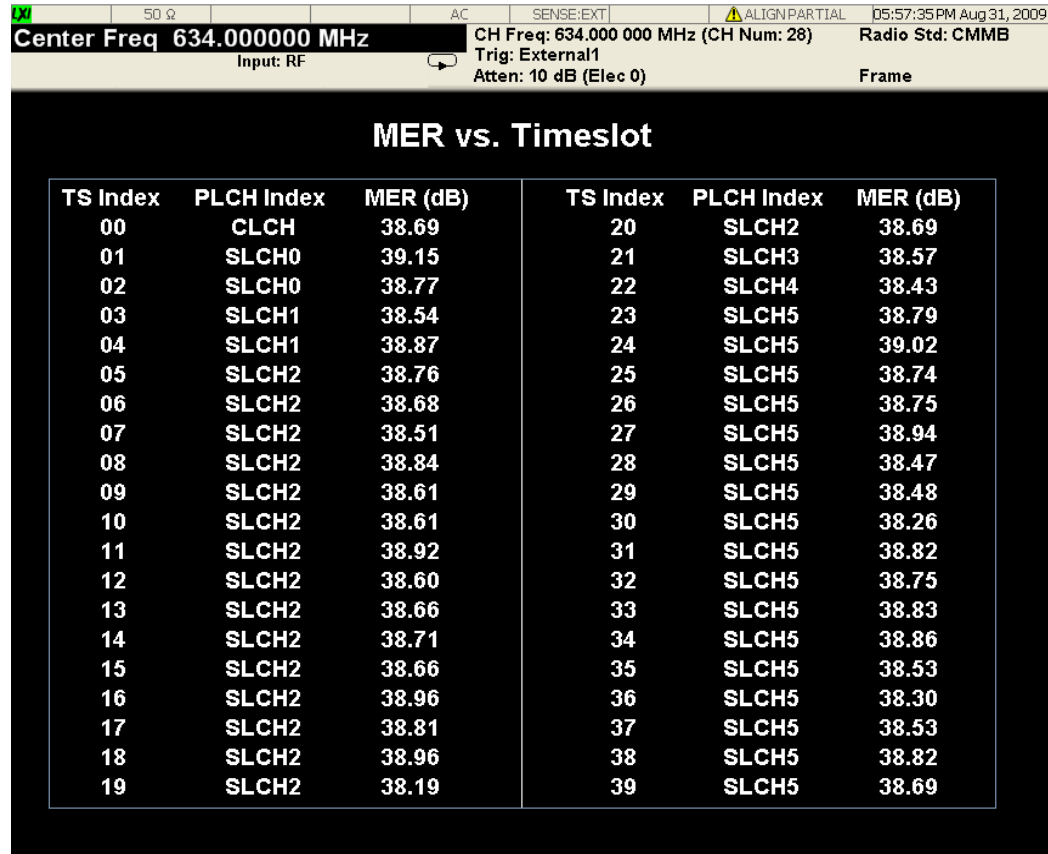

MER vs. Timeslot window

Key Path	View/Display
Example	:DISPlay:EVM:VIEW MERTimeslot :DISPlay:EVM:VIEW?
Initial S/W Revision	A.06.00

Result Metrics

Selects the result metrics view.

There is one window, “[Result Metrics Summary Window](#)” on page 731, which shows the summary of modulation accuracy result metrics.

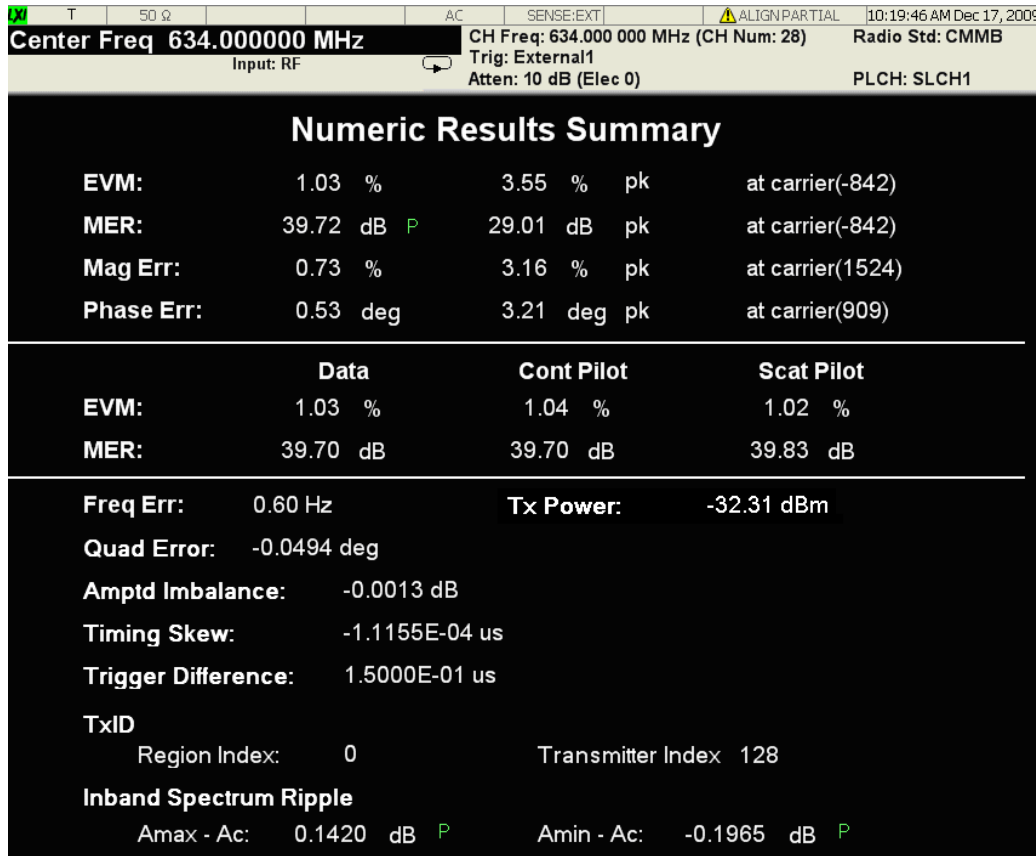

NOTE In the 'TxID' results, the value of 'Region Index' or 'Transmitter Index' may be displayed as '---' when there is only one timeslot measured, as the 'Transmitter Index' and 'Region Index' are carried in odd timeslots and even timeslots separately.

Result Metrics Summary Window

This window shows the summary of the results.

Name	Corresponding Results	Format
EVM	n=1 1st EVM of the current symbols	99.99 %
Peak EVM	n=1 2nd Peak EVM of the current symbols	99.99 %
Peak EVM Position	n=1 3rd Sub-carrier number corresponding to the position of peak EVM is returned	at carrier (9999)

Name	Corresponding Results	Format
MER	n=1, 4th MER of the current symbols	99.99 dB
Peak MER	n=1 5th Peak MER of the current symbols	99.99 dB
Peak MER Position	n=1 6th Sub-carrier number corresponding to the position of peak MER is returned	at carrier (9999)
Mag Error	n=1 7th Magnitude error of the current symbols	99.99 %
Peak Mag Error	n=1 8th Peak magnitude error of the current symbols	99.99 %
Peak Mag Error Position	n=1 9th Sub-carrier number corresponding to the position of peak magnitude error is returned	at carrier (9999)
Phase Error	n=1 10th Phase error of the current symbols	99.99 deg
Peak Phase Error	n=1 11th Peak phase error of the current symbols	99.99 deg
Peak Phase Error Position	n=1 12th Sub-carrier number corresponding to the position of peak phase error is returned	at carrier (9999)
Freq Err	n=1 13th Frequency error of the current symbols	99.99 Hz
Amptd Imbalance	n=1 14th Amplitude imbalance of the current symbols	99.9999 dB
Quad Err	n=1 15th Quadrature error of the current symbols	99.9999 deg
Timing Skew	n=1 16th Timing skew of the current symbols	9.9999E9 us
Data EVM	n=1 21st EVM of data in the current symbols	99.99 %
Cont Pilot EVM	n=1 22nd EVM of continued pilot in the current symbols	99.99 %

Name	Corresponding Results	Format
Scat Pilot EVM	n=1 23rd EVM of scattered pilot in the current symbols	99.99 %
Data MER	n=1 24th MER of data in the current symbols	99.99 dB
Cont Pilot MER	n=1 25th MER of continued pilot in the current symbols	99.99 dB
Scat Pilot MER	n=1 26th MER of scattered pilot in the current symbols	99.99 dB
Trigger Difference	n=1 27th Trigger Difference in the current symbols	9.9999E9 us
Region Index	n=1 28th Region Index of the current signal	999
Transmitter Index	n=1 29th Transmitter Index of the current signal	999
Current Slot	n=1 30th In 'Free Run', it is the currently detected time slot index in a measurement cycle. Otherwise, it will be -999.	99
Tx Power	n=1 31st Average Tx power	99.99 dBm

Key Path	View/Display
Example	:DISPlay:EVM:VIEW NRESults :DISPlay:EVM:VIEW?
Initial S/W Revision	A.03.00

View Selection by number (Remote Command SCPI only)

Selects the desired measurement view by number.

Key Path	SCPI only
Mode	CMMB
Remote Command	:DISPlay:EVM:VIEW:NSElect <integer> :DISPlay:EVM:VIEW:NSElect?

Mod Accuracy Measurement
View/Display

Example	DISP:EVM:VIEW:NSEL 0 DISP:EVM:VIEW:NSEL?
Notes	Meaning of the numeric values: 0: I/Q Measured Polar Graph View 1: I/Q Error View 2: Channel Frequency Response View 3: Channel Impulse Response View 4: Spectral Flatness View 5: MER vs. Timeslot View 6: Result Metrics View
Preset	0
State Saved	Saved in instrument state.
Min	0
Max	6
Initial S/W Revision	A.03.00

The Occupied Bandwidth measurement computes and displays the bandwidth occupied by a given percentage of the total mean power of a signal. For measurement results and views, see [“View/Display” on page 786](#).

This topic contains the following sections:

[“Remote Commands for Occupied Bandwidth ” on page 735](#)

[“Remote Command Results for Occupied Bandwidth Measurement” on page 736](#)

Remote Commands for Occupied Bandwidth

```
:CONFigure:OBWidth  
:CONFigure:OBWidth:NDEFault  
:INITiate:OBWidth  
:FETCh:OBWidth [n] ?  
:MEASure:OBWidth [n] ?  
:READ:OBWidth [n] ?  
:FETCh:OBWidth:OBWidth?  
:MEASure:OBWidth:OBWidth?  
:READ:OBWidth:OBWidth?  
:FETCh:OBWidth:FERRor?  
:MEASure:OBWidth:FERRor?  
:READ:OBWidth:FERRor?  
:FETCh:OBWidth:XDB?  
:MEASure:OBWidth:XDB?  
:READ:OBWidth:XDB?
```

See also the section, [“Remote Measurement Functions” on page 1083](#).

Remote Command Results for Occupied Bandwidth Measurement

n	Results Returned
n=1 (or not specified)	Returns 6 scalar results, in the following order: <ol style="list-style-type: none"> 1. Occupied bandwidth – Hz 2. Total Power – dBm (Total Power will be obsolete in TD-SCDMA mode, this place will be replaced by NaN) 3. Span - Hz 4. Spectrum Trace Points - points 5. Res BW – Hz 6. Transmit Frequency Error Hz 7. x DB Bandwidth - Hz
2	Returns the frequency-domain spectrum trace (data array) for the entire frequency range being measured.

Key Path	Meas
Initial S/W Revision	Prior to A.02.00

AMPTD Y Scale

Activates the Reference Value function and displays the Amplitude menu keys. These functions control how data on the vertical (Y) axis is displayed and control instrument settings that affect the vertical axis

See “AMPTD Y Scale” on page 909 for more information.

Key Path	Front-panel key
Initial S/W Revision	Prior to A.02.00

Ref Value

Sets the absolute power reference value. However, since the Auto Scaling is defaulted to On, this value is automatically determined by the measurement result. When you set a value manually, Auto Scaling automatically changes to Off.

Key Path	AMPTD Y Scale
Mode	SA, WCDMA, C2K, WIMAX OFDMA, TD-SCDMA, 1xEVDO, ISDB-T, CMMB, LTE, LTETDD
Remote Command	:DISPlay:OBWidth:VIEW[1]:WINDow[1]:TRACe:Y[:SCALe]:RLEV e1 <real> :DISPlay:OBWidth:VIEW[1]:WINDow[1]:TRACe:Y[:SCALe]:RLEV e1?
Example	DISP:OBW:VIEW:WIND:TRAC:Y:RLEV 125 DISP:OBW:VIEW:WIND:TRAC:Y:RLEV?
Notes	You must be in the Spectrum Analysis mode, W-CDMA mode, cdma2000 mode, TD-SCDMA mode, ISDB-T mode, CMMB mode, LTE mode, LTE TDD mode 1xEVDO mode or WIMAX OFDMA mode to use this command. Use:INSTRument:SElect to set the mode.
Couplings	When the Auto Scaling is On, this value is automatically determined by the measurement result. When you set a value manually, Auto Scaling automatically changes to Off.
Preset	10.00 dBm
State Saved	Saved in instrument state.
Min	-250.00 dBm
Max	250.00 dBm
Initial S/W Revision	Prior to A.02.00
Modified at S/W Revision	A.03.00

Attenuation

Accesses a menu of functions that enable you to change the attenuation settings. This key has read-back text that describes the total attenuator value.

See “Attenuation” on page 910 for more information.

Key Path	AMPTD Y Scale
Initial S/W Revision	Prior to A.02.00

Scale/Div

Sets the logarithmic units per vertical graticule division on the display. When the Auto Scaling is On, the Scale/Div is automatically determined by the measurement result. When you set a value manually, Auto Scaling is automatically toggled to Off.

Key Path	AMPTD Y Scale
Mode	SA, WCDMA, C2K, WIMAX OFDMA, TD-SCDMA, 1xEVDO, ISDB-T, CMMB, LTE, LTETDD
Remote Command	:DISPlay:OBWidth:VIEW[1]:WINDow[1]:TRACe:Y[:SCALe]:PDIV ision <rel_ampl> :DISPlay:OBWidth:VIEW[1]:WINDow[1]:TRACe:Y[:SCALe]:PDIV ision?
Example	DISP:OBW:VIEW:WIND:TRAC:Y:PDIV 5 DISP:OBW:VIEW:WIND:TRAC:Y:PDIV?
Notes	You must be in the Spectrum Analysis mode, W-CDMA mode, cdma2000 mode, TD-SCDMA mode, ISDB-T mode, CMMB mode, LTE mode, LTE TDD mode, 1xEVDO mode or WIMAX OFDMA mode to use this command. Use:INSTrument:SELEct to set the mode.
Couplings	When the Auto Scaling is On, this value is automatically determined by the measurement result. When you set a value manually, Auto Scaling automatically changes to Off.
Preset	10.00 dB
State Saved	Saved in instrument state.
Min	0.10 dB
Max	20.00 dB
Initial S/W Revision	Prior to A.02.00
Modified at S/W Revision	A.03.00

Presel Center

When this key is pressed, the centering of the preselector filter is adjusted to optimize the amplitude

accuracy at the frequency of the selected marker.

See [“Presel Center” on page 926](#) for more information.

Key Path	AMPTD/Y Scale
Initial S/W Revision	Prior to A.02.00

Presel Adjust

Allows you to manually adjust the preselector filter frequency to optimize its response to the signal of interest. This function is only available when Presel Center is available.

See [“Preselector Adjust” on page 927](#) for more information.

Key Path	AMPTD/Y Scale
Initial S/W Revision	Prior to A.02.00

Y Axis Unit

Allows you to change the vertical (Y) axis amplitude unit.

See [“Y Axis Unit” on page 929](#) under AMPTD Y Scale in the "Common Measurement Functions" section for more information.

Key Path	AMPTD/Y Scale
Initial S/W Revision	A.04.00

Reference Level Offset

Adds an offset value to the displayed reference level. The reference level is the absolute amplitude represented by the top graticule line on the display.

See [“Reference Level Offset” on page 934](#) under AMPTD Y Scale in the "Common Measurement Functions" section for more information.

Key Path	AMPTD/Y Scale
Initial S/W Revision	A.04.00

μ W Path Control

The **μ W Path Control** functions include the **μ W Preselector Bypass** (Option MPB) and **Low Noise Path** (Option LNP) controls in the High Band path circuits.

See [“ \$\mu\$ W Path Control ” on page 935](#) under AMPTD Y Scale in the "Common Measurement Functions" section for more information.

Key Path	AMPTD/Y Scale
----------	----------------------

Initial S/W Revision	A.04.00
----------------------	---------

Internal Preamp

Accesses a menu of functions that enable you to control the internal preamplifiers.

See “[Internal Preamp](#)” on page 939 for more information.

Key Path	AMPTD Y Scale
Initial S/W Revision	Prior to A.02.00

Ref Position

Positions the reference level at the top, center or bottom of the Y Scale display. Changing the reference position does not change the reference level value.

Key Path	AMPTD Y Scale
Mode	SA, WCDMA, C2K, WIMAX OFDMA, TD-SCDMA, 1xEVDO, ISDB-T, CMMB, LTE, LTETDD
Remote Command	:DISPlay:OBWidth:VIEW[1]:WINDow[1]:TRACe:Y[:SCALE]:RPOS ition TOP CENTer BOTTom :DISPlay:OBWidth:VIEW[1]:WINDow[1]:TRACe:Y[:SCALE]:RPOS ition?
Example	DISP:OBW:VIEW:WIND:TRAC:Y:RPOS BOTT DISP:OBW:VIEW:WIND:TRAC:Y:RPOS?
Notes	You must be in the Spectrum Analysis mode, W-CDMA mode, cdma2000 mode, TD-SCDMA mode, ISDB-T mode, CMMB mode, LTE mode, LTE TDD mode, 1xEVDO mode or WIMAX OFDMA mode to use this command. Use:INSTrument:SElect to set the mode.
Preset	TOP
State Saved	Saved in instrument state.
Range	Top Ctr Bot
Initial S/W Revision	Prior to A.02.00
Modified at S/W Revision	A.03.00

Auto Scaling

Allows you to toggle the Auto Scaling function between On and Off.

Key Path	AMPTD Y Scale
----------	----------------------

Mode	SA, WCDMA, C2K, WIMAX OFDMA, TD-SCDMA, 1xEVDO, ISDB-T, CMMB, LTE, LTETDD
Remote Command	:DISPlay:OBWidth:VIEW[1]:WINDow[1]:TRACe:Y[:SCALe]:COUP le 0 1 OFF ON :DISPlay:OBWidth:VIEW[1]:WINDow[1]:TRACe:Y[:SCALe]:COUP le?
Example	DISP:OBW:VIEW:WIND:TRAC:Y:COUP ON DISP:OBW:VIEW:WIND:TRAC:Y:COUP?
Couplings	When Auto Scaling is On, upon pressing the Restart front-panel key, this function automatically sets the scale per division to 10 dB and determines reference values based on the measurement results. When you set a value to either Scale/Div or Ref Value manually, Auto Scaling automatically changes to Off.
Preset	1
State Saved	Saved in instrument state.
Range	On Off
Initial S/W Revision	Prior to A.02.00
Modified at S/W Revision	A.03.00

Auto Couple

The Auto Couple function is not supported in this measurement.

BW

Accesses a menu of functions that enable you to specify and control the video and resolution bandwidths. You can also select the type of filter for the measurement.

Key Path	Front-panel key
Initial S/W Revision	Prior to A.02.00

Res BW

Sets the resolution bandwidth for the current measurement. If an unavailable bandwidth is entered with the numeric keypad, the closest available bandwidth is selected.

Key Path	BW
Mode	SA, WCDMA, C2K, WIMAX OFDMA, TD-SCDMA, 1xEVDO, ISDB-T, CMMB, LTE, LTETDD
Remote Command	[:SENSE] :OBwidth: BANDwidth[:RESolution] <bandwidth> [:SENSE] :OBwidth: BANDwidth[:RESolution] ? [:SENSE] :OBwidth: BANDwidth[:RESolution] :AUTO ON OFF 1 0 [:SENSE] :OBwidth: BANDwidth[:RESolution] :AUTO?
Example	OBW:BAND 250000 OBW:BAND? OBW:BAND:AUTO OFF OBW:BAND:AUTO?
Notes	You must be in the Spectrum Analysis mode, W-CDMA mode, cdma2000 mode, TD-SCDMA mode, ISDB-T mode, CMMB mode, LTE mode, LTE TDD mode, 1xEVDO mode or WIMAX OFDMA mode to use this command. Use:INSTrument:SElect to set the mode.
Couplings	Sweep time is coupled to RBW. As the RBW changes, the sweep time (if set to Auto) is changed to maintain amplitude calibration. Video bandwidth (VBW) is coupled to RBW. As the resolution bandwidth changes, the video bandwidth (if set to Auto) changes to maintain the ratio of VBW/RBW (10:1). When Res BW is set to Auto, the resolution bandwidth is auto-coupled to span. The ratio of Span/RBW is approximately 106:1 when auto coupled. When Res BW is set to Man, bandwidths are entered manually, and these bandwidths are used regardless of other analyzer settings.

Occupied Bandwidth Measurement
BW

Preset	SA: Auto WCDMA: 30 kHz CDMA2K: 12 kHz WIMAX OFDMA: 100kHz TD-SCDMA: 30kHz 1xEVDO: 30kHz ISDB-T: 10kHz CMMB: 3kHz LTE: 30 kHz LTETDD: 30 kHz BLUETOOTH 10 kHz SA: ON WCDMA, C2K,TD-SCDMA,WIMAX OFDMA, 1xEVDO ,ISDB-T, CMMB, LTE, LTETDD: OFF
State Saved	Saved in instrument state.
Min	1 Hz
Max	8 MHz
Backwards Compatibility SCPI	[[:SENSe]:OBWidth:BWIDth[:RESolution]
Initial S/W Revision	Prior to A.02.00
Modified at S/W Revision	A.03.00

Video BW

Changes the analyzer post-detection filter.

Key Path	BW
Mode	SA, WCDMA, C2K, WIMAX OFDMA, TD-SCDMA, 1xEVDO, ISDB-T, CMMB, LTE, LTETDD
Remote Command	[[:SENSe]:OBWidth:BAWdwidth:VIDeo <bandwidth> [:SENSe]:OBWidth:BAWdwidth:VIDeo? [:SENSe]:OBWidth:BAWdwidth:VIDeo:AUTO ON OFF 1 0 [:SENSe]:OBWidth:BAWdwidth:VIDeo:AUTO?
Example	OBW:BAWd:VID 5 MHz OBW:BAWd:VID? OBW:BAWd:VID:AUTO ON OBW:BAWd:VID:AUTO?

Notes	You must be in the Spectrum Analysis mode, W-CDMA mode, cdma2000 mode, TD-SCDMA mode, ISDB-T mode, CMMB mode, LTE mode, LTE TDD mode, 1xEVDO mode or WIMAX OFDMA mode to use this command. Use:INSTrument:SElect to set the mode.
Dependencies	When using the average detector with either Sweep Time set to Man, or in zero span, the VBW setting has no effect and is disabled (grayed out).
Couplings	<p>Video bandwidth (VBW) is coupled to RBW. As the resolution bandwidth changes, the video bandwidth (if set to Auto) changes to maintain the ratio set by VBW/RBW.</p> <p>Sweep Time is coupled to Video Bandwidth (VBW). As the VBW is changed, the sweep time (when set to Auto) is changed to maintain amplitude calibration. This occurs because of common hardware between the two circuits, even though the Video BW filter is not actually “in-circuit” when the detector is set to Average. Because the purpose of the average detector and the VBW filter are the same, either can be used to reduce the variance of the result.</p> <p>Although the VBW filter is not “in-circuit” when using the average detector, the Video BW key can have an effect on (Auto) sweep time, and is not disabled. In this case, reducing the VBW setting increases the sweep time, which increases the averaging time, producing a lower-variance trace.</p> <p>When the video bandwidth is AUTO coupled, the video bandwidth value is set to: Resolution Bandwidth * Video Bandwidth to Resolution Bandwidth Ratio</p>
Preset	SA, LTE, LTETDD: Auto WCDMA: 300 kHz CDMA2K:120 kHz WIMAX OFDMA: 1MHz TD-SCDMA: 300kHz 1xEVDO: 300kHz ISDB-T: 300Hz CMMB: 3kHz BLUETOOTH: 30kHz (TBD) ON ISDB-T, CMMB: OFF
State Saved	Saved in instrument state.
Min	1 Hz
Max	50 MHz
Backwards Compatibility SCPI	[:SENSe]:OBWidth:BWIDth:VIDeo
Initial S/W Revision	Prior to A.02.00

Modified at S/W Revision	A.03.00
--------------------------	---------

Filter Type

Allows you to select the type of filter to be used for the current measurement. Besides the Gaussian filter shape, there are certain special filter types, such as Flat Top, that are desirable under certain conditions.

Key Path	BW
Mode	SA, WCDMA, C2K, WIMAX OFDMA, TD-SCDMA, 1xEVDO, ISDB-T, CMMB, LTE, LTETDD
Remote Command	[:SENSe] :OBWidth :BANDwidth :SHAPE GAUSSian FLATtop [:SENSe] :OBWidth :BANDwidth :SHAPE?
Example	OBW:BAND:SHAP GAUS OBW:BAND:SHAP?
Preset	GAUSSian
State Saved	Saved in instrument state.
Range	Gaussian Flattop
Backwards Compatibility SCPI	[:SENSe] :OBWidth :BWIDth :SHAPE
Initial S/W Revision	Prior to A.02.00
Modified at S/W Revision	A.03.00

Cont (Continuous)

See “[Cont \(Continuous Measurement/Sweep\)](#)” on page 957 in the section "Common Measurement Functions" for more information.

FREQ/Channel (Frequency or Channel)

See “[FREQ Channel](#)” on page 959 in the section "Common Measurement Functions" for more information.

Input/Output

See “[Input/Output](#)” on page 969 in the section "Common Measurement Functions" for more information.

Marker

Accesses a menu that enables you to select, set up and control the markers for the current measurement.

For more information, see “[Marker](#)” on page 1039.

Key Path	Front-panel key
Initial S/W Revision	Prior to A.02.00

Select Marker

Displays the menu keys that enable you to select, set up and control the markers for the current measurement

Key Path	Marker
Initial S/W Revision	Prior to A.02.00

Marker X Axis Value (Remote Command only)

Sets the marker X Axis value in the current marker X Axis Scale unit. It has no effect if the control mode is **Off**.

Mode	SA, WCDMA, C2K, WIMAX OFDMA, TD-SCDMA, 1xEVDO, ISDB-T, CMMB, LTE, LTETDD
Remote Command	:CALCulate:OBWidth:MARKer [1] 2 3 4 5 6 7 8 9 10 11 12 :X <real> :CALCulate:OBWidth:MARKer [1] 2 3 4 5 6 7 8 9 10 11 12 :X ?
Example	CALC:OBW:MARK3:X 0 CALC:OBW:MARK3:X?
Notes	The query returns the marker’s absolute X Axis value if the control mode is Normal , or the offset from the marker’s reference marker if the control mode is Delta . The query is returned in the fundamental units for the current marker X Axis scale: Hz for Frequency .
Preset	After a preset, all markers are turned OFF, so Marker X Axis Value query returns a not a number (NAN).
State Saved	No
Min	-9.9E+37
Max	9.9E+37
Initial S/W Revision	Prior to A.02.00

Modified at S/W Revision	A.03.00
--------------------------	---------

Marker X Axis Position (Remote Command only)

Sets the marker X position in trace points. It has no effect if the control mode is **Off**.

Mode	SA, WCDMA, C2K, WIMAX OFDMA, TD-SCDMA, 1xEVDO, ISDB-T, CMMB, LTE, LTETDD
Remote Command	:CALCulate:OBWidth:MARKer [1] 2 3 4 5 6 7 8 9 10 11 12 :X :POSition <real> :CALCulate:OBWidth:MARKer [1] 2 3 4 5 6 7 8 9 10 11 12 :X :POSition?
Example	CALC:OBW:MARK10:X:POS 0 CALC:OBW:MARK10:X:POS?
Notes	The query returns the marker's absolute X Axis value in trace points if the control mode is Normal , or the offset from the marker's reference marker in trace points if the control mode is Delta .
Preset	After a preset, all markers are turned OFF, so Marker X Axis Value query returns a not a number (NAN).
State Saved	No
Min	-9.9E+37
Max	9.9E+37
Initial S/W Revision	Prior to A.02.00
Modified at S/W Revision	A.03.00

Marker Y Axis Value (Remote Command only)

Returns the marker Y Axis value in the current marker Y Axis unit.

Mode	SA, WCDMA, C2K, WIMAX OFDMA, TD-SCDMA, 1xEVDO, ISDB-T, CMMB, LTE, LTETDD
Remote Command	:CALCulate:OBWidth:MARKer [1] 2 3 4 5 6 7 8 9 10 11 12 :Y ?
Example	CALC:OBW:MARK11:Y?
Preset	Result dependent on Markers setup and signal source.
State Saved	No
Initial S/W Revision	Prior to A.02.00
Modified at S/W Revision	A.03.00

Marker Type

Sets the marker control mode to **Normal**, **Delta** or **Off**. If the selected marker is Off, pressing Marker sets it to Normal and places a single marker at the center of the display. At the same time, **Marker X Axis Value** appears on the Active Function area.

Key Path	Marker
Mode	SA, WCDMA, C2K, WIMAX OFDMA, TD-SCDMA, 1xEVDO, ISDB-T, CMMB, LTE, LTETDD
Remote Command	:CALCulate:OBWidth:MARKer [1] 2 3 4 5 6 7 8 9 10 11 12 :M ODE POSition DELTa OFF :CALCulate:OBWidth:MARKer [1] 2 3 4 5 6 7 8 9 10 11 12 :M ODE?
Example	CALC:OBW:MARK:MODE POS CALC:OBW:MARK:MODE?
Notes	If the selected marker is Off, pressing Marker sets it to Normal and places it at the center of the screen on the trace determined by the Marker Trace rules. At the same time, Marker X Axis Value appears on the Active Function area. Default Active Function: the active function for the selected marker's current control mode. If the current control mode is Off, there is no active function and the active function is turned off. Active Function Display: the marker X axis value entered in the active function area displays the marker value to its full entered precision.
Preset	OFF
State Saved	Saved in instrument state.
Range	Normal Delta Off
Initial S/W Revision	Prior to A.02.00
Modified at S/W Revision	A.03.00

Properties

Accesses the marker properties menu.

Key Path	Marker
Initial S/W Revision	Prior to A.02.00

Select Marker

Displays 12 markers available for selection.

Key Path	Marker, Properties
----------	--------------------

Initial S/W Revision	Prior to A.02.00
----------------------	------------------

Relative To

Selects the desired marker. The selected marker will be relative to its reference marker.

Key Path	Marker, Properties
Mode	SA, WCDMA, C2K, WIMAX OFDMA, TD-SCDMA, 1xEVDO, ISDB-T, CMMB, LTE, LTETDD
Remote Command	:CALCulate:OBWidth:MARKer [1] 2 3 4 5 6 7 8 9 10 11 12 :R EFerence <integer> :CALCulate:OBWidth:MARKer [1] 2 3 4 5 6 7 8 9 10 11 12 :R EFerence?
Example	CALC:OBW:MARK:REF 2 CALC:OBW:MARK:REF?
Notes	A marker cannot be relative to itself so that choice is grayed out, and if sent from SCPI generates error -221: "Settings conflict; marker cannot be relative to itself." When queried a single value is returned (the specified marker numbers relative marker). You must be in the Spectrum Analysis mode, WCDMA mode, TD-SCDMA mode, 1xEVDO mode, WIMAX OFDMA mode ISDB-T mode, CMMB mode, LTE mode, or LTETDD mode to use this command. Use:INSTrument:SElect to set the mode.
Preset	2 3 4 5 6 7 8 9 10 11 12 1
State Saved	Saved in instrument state.
Min	1
Max	12
Initial S/W Revision	Prior to A.02.00
Modified at S/W Revision	A.03.00

All Markers Off

Turns off all markers.

Key Path	Marker
Mode	SA, WCDMA, C2K, WIMAX OFDMA, TD-SCDMA, 1xEVDO, ISDB-T, CMMB, LTE, LTETDD
Remote Command	:CALCulate:OBWidth:MARKer:AOff
Example	CALC:OBW:MARK:AOff

Initial S/W Revision	Prior to A.02.00
Modified at S/W Revision	A.03.00

Backward Compatibility SCPI Commands

Sets or queries the state of a marker. Setting a marker which is OFF to state ON or 1 puts it in Normal mode and places it at the center of the screen.

Mode	SA, WCDMA, C2K, WIMAX OFDMA, TD-SCDMA, 1xEVDO, ISDB-T, CMMB, LTE, LTETDD
Remote Command	:CALCulate:OBwidth:MARKer [1] 2 3 4 5 6 7 8 9 10 11 12 :S TATe OFF ON 0 1 :CALCulate:OBwidth:MARKer [1] 2 3 4 5 6 7 8 9 10 11 12 :S TATe?
Example	CALC:OBW:MARK3:STAT ON CALC:OBW:MARK3:STAT?
Preset	OFF
State Saved	Saved in instrument state.
Range	On Off
Initial S/W Revision	Prior to A.02.00
Modified at S/W Revision	A.03.00

Marker Function

There are no 'Marker Functions' supported in this measurement.

Key Path	Front panel key
Initial S/W Revision	Prior to A.02.00

Marker To

There is no 'Marker To' functionality supported in this measurement.

Key Path	Front panel key
Initial S/W Revision	Prior to A.02.00

Meas

See [“Meas” on page 1083](#) in the section "Common Measurement Functions" for more information.

Meas Setup

Displays the setup menu for the current measurement. The measurement setup parameters include the number of measurement averages used to calculate the measurement result and the averaging mode. The setup menu also includes the option to reset the measurement settings to their factory defaults.

Key Path	Front-panel key
Initial S/W Revision	Prior to A.02.00

Avg/Hold Num

Specifies the number of measurement averages used when calculating the measurement result. The average is displayed at the end of each sweep.

Initiates an averaging routine that averages the sweep points in a number of successive sweeps, resulting in trace smoothing.

After the specified number of average counts, the average mode (termination control) setting determines the average action.

Key Path	Meas Setup
Mode	SA, WCDMA, C2K, WIMAX OFDMA, TD-SCDMA, 1xEVDO, ISDB-T, CMMB, LTE, LTETDD
Remote Command	[:SENSe]:OBWidth:AVERage:COUNT <integer> [:SENSe]:OBWidth:AVERage:COUNT? [:SENSe]:OBWidth:AVERage[:STATe] ON OFF 1 0 [:SENSe]:OBWidth:AVERage[:STATe]?
Example	OBW:AVER:COUN 1500 OBW:AVER:COUN? OBW:AVER ON OBW:AVER?
Notes	You must be in the Spectrum Analysis mode, W-CDMA mode, cdma2000 mode, TD-SCDMA mode, ISDB-T mode, CMMB mode, LTE mode, LTE TDD mode, 1xEVDO mode or WIMAX OFDMA mode to use this command. Use:INSTrument:SELEct to set the mode.
Couplings	None Averaging state is coupled to Max Hold. If Max Hold is changed from Off to On, Averaging state is automatically set to On.
Preset	10 ON

State Saved	Saved in instrument state.
Min	1
Max	10000
Backwards Compatibility SCPI	[:SENSe]:EBWidth:AVERage:COUNT
Initial S/W Revision	Prior to A.02.00
Modified at S/W Revision	A.03.00

Avg Mode

Enables you to set the averaging mode.

When set to Exponential (Exp) the measurement averaging continues using the specified number of averages to compute each averaged value. The average is displayed at the end of each sweep.

When set to Repeat, the measurement resets the average counter each time the specified number of averages is reached.

Key Path	Meas Setup
Mode	SA, WCDMA, C2K, WIMAX OFDMA, TD-SCDMA , 1xEVDO, ISDB-T, CMMB, LTE, LTETDD
Remote Command	[:SENSe]:OBWidth:AVERage:TCONtrol EXPonential REPEAT [:SENSe]:OBWidth:AVERage:TCONtrol?
Example	OBW:AVER:TCON REP OBW:AVER:TCON?
Notes	You must be in the Spectrum Analysis mode, W-CDMA mode, cdma2000 mode, TD-SCDMA mode, ISDB-T mode, CMMB mode, LTE mode, LTE TDD mode, 1xEVDO mode or WIMAX OFDMA mode to use this command. Use:INSTrument:SElect to set the mode.
Preset	EXP
State Saved	Saved in instrument state.
Range	Exp Repeat
Initial S/W Revision	Prior to A.02.00
Modified at S/W Revision	A.03.00

Max Hold (Remote Command Only)

When On, Max Hold displays and holds the maximum responses of the current measurement. Turn Max

Occupied Bandwidth Measurement
Meas Setup

Hold to Off to disable the maximum hold feature.

Mode	SA, WCDMA, C2K, WIMAX OFDMA, TD-SCDMA, 1xEVDO, ISDB-T, CMMB, LTE, LTETDD
Remote Command	[[:SENSE]:OBWidth:MAXHold ON OFF 1 0 [:SENSE]:OBWidth:MAXHold?
Example	OBW:MAXH ON OBW:MAXH?
Notes	You must be in the Spectrum Analysis mode, W-CDMA mode, cdma2000 mode, TD-SCDMA mode, ISDB-T mode, CMMB mode, LTE mode, LTE TDD mode, 1xEVDO mode or WIMAX OFDMA mode to use this command. Use:INSTrument:SELEct to set the mode.
Couplings	Max Hold is coupled to Average/Hold state. The Max Hold function is activated only if Average state is On. If Max Hold is changed to On when Average state is Off, Average state is automatically set to On.
Preset	OFF
State Saved	Saved in instrument state.
Range	On Off
Backwards Compatibility SCPI	[[:SENSE]:EBWidth:MAXHold
Initial S/W Revision	Prior to A.02.00
Modified at S/W Revision	A.03.00

Occ BW % Pwr

Assigns the percentage of the total power that is measured within the Occupied Bandwidth for the current measurement. The resulting Occupied Bandwidth limits are displayed by markers placed on the frequencies of the specified percentage.

Key Path	Meas Setup
Mode	SA, WCDMA, C2K, WIMAX OFDMA, TD-SCDMA, 1xEVDO, ISDB-T, CMMB, LTE, LTETDD
Remote Command	[[:SENSE]:OBWidth:PERCent <real> [:SENSE]:OBWidth:PERCent?
Example	OBW:PERC 75 OBW:PERC?

Notes	You must be in the Spectrum Analysis mode, W-CDMA mode, cdma2000 mode, TD-SCDMA mode, ISDB-T mode, CMMB mode, LTE mode, LTE TDD mode, 1xEVDO mode or WIMAX OFDMA mode to use this command. Use:INSTrument:SElect to set the mode. If Mode is BLUETOOTH, the key will be grayed out.
Preset	99.00
State Saved	Saved in instrument state.
Min	10
Max	99.99
Initial S/W Revision	Prior to A.02.00
Modified at S/W Revision	A.03.00

x dB

Sets the x dB value used for the "x dB bandwidth" result that measures the bandwidth between two points on the signal which is x dB down from the highest signal point within the OBW Span.

Key Path	Meas Setup
Mode	SA, WCDMA, C2K, WIMAX OFDMA, TD-SCDMA, 1xEVDO, ISDB-T, CMMB, LTE, LTETDD
Remote Command	[:SENSe] :OBWidth:XDB <rel_ampl> [:SENSe] :OBWidth:XDB?
Example	OBW:XDB -20 OBW:XDB?
Notes	You must be in the Spectrum Analysis mode, W-CDMA mode, cdma2000 mode, TD-SCDMA mode, ISDB-T mode, CMMB mode, LTE mode, LTE TDD mode, 1xEVDO mode or WIMAX OFDMA mode to use this command. Use:INSTrument:SElect to set the mode.
Preset	-26.0 dB BLUETOOTH: -20.0 dB.
State Saved	Saved in instrument state.
Min	-100.0 dB
Max	-0.1 dB
Backwards Compatibility SCPI	[:SENSe] :EBWidth:XDB
Initial S/W Revision	Prior to A.02.00
Modified at S/W Revision	A.03.00

IF Gain

The **IF Gain** key can be used to set the IF Gain function to Auto, Low Gain or High Gain. These settings affect sensitivity and IF overloads.

This only applies to the RF input. It does not apply to baseband I/Q input.

Key Path	Meas Setup, IF Gain
Initial S/W Revision	Prior to A.02.00

IF Gain Auto

Activates the Auto Rules for IF Gain. When Auto is active, the IF Gain is set to High Gain under and of the following conditions:

- the input attenuator is set to 0 dB
- the preamp is turned On and the frequency range is under 3.6 GHz

For other settings, Auto sets the IF Gain to Low Gain.

Key Path	Meas Setup, IF Gain
Mode	SA, WCDMA, C2K, WIMAX OFDMA, TD-SCDMA, 1xEVDO, ISDB-T, CMMB, LTE, LTETDD
Remote Command	[:SENSE] :OBWidth:IF:GAIN:AUTO [:STATE] ON OFF 1 0 [:SENSE] :OBWidth:IF:GAIN:AUTO [:STATE] ?
Example	OBW:IF:GAIN:AUTO OFF OBW:IF:GAIN:AUTO?
Couplings	When the auto attenuation exists (for example, with electrical attenuator), the IF Gain setting is changed as following rule. Auto sets IF Gain to High Gain under any of the following conditions: the input attenuator is set to 0 dB, or the preamp is turned on and the frequency range is less than 3.6 GHz. For other settings, Auto sets IF Gain to Low Gain.
Preset	OFF
State Saved	Saved in instrument state.
Range	Off On
Initial S/W Revision	Prior to A.02.00
Modified at S/W Revision	A.03.00

IF Gain State

Selects the range of the IF Gain.

Key Path	Meas Setup, IF Gain
----------	----------------------------

Mode	SA, WCDMA, C2K, WIMAX OFDMA, TD-SCDMA, 1xEVDO, ISDB-T, CMMB, LTE, LTETDD
Remote Command	[:SENSe] :OBwidth:IF:GAIN [:STATe] ON OFF 1 0 [:SENSe] :OBwidth:IF:GAIN [:STATe] ?
Example	OBW:IF:GAIN ON OBW:IF:GAIN?
Notes	Where ON = high gain OFF = low gain
Couplings	When the auto attenuation exists (for example, with electrical attenuator), the IF Gain setting is changed as following rule. Auto sets IF Gain to High Gain under any of the following conditions: the input attenuator is set to 0 dB, or the preamp is turned on and the frequency range is less than 3.6 GHz. For other settings, Auto sets IF Gain to Low Gain.
Preset	OFF
State Saved	Saved in instrument state.
Range	Low Gain High Gain
Initial S/W Revision	Prior to A.02.00
Modified at S/W Revision	A.03.00

Limit

Enables you to turn on or off limit checking at the specified frequency. For results that fail the limit test, a red FAIL appears in the measure bar.

Key Path	Meas Setup
Mode	SA, WCDMA, C2K, WIMAX OFDMA, TD-SCDMA, 1xEVDO, ISDB-T, CMMB, LTE, LTETDD
Remote Command	:CALCulate:OBwidth:LIMit:FBLimit <freq> :CALCulate:OBwidth:LIMit:FBLimit? :CALCulate:OBwidth:LIMit[:TEST] ON OFF 1 0 :CALCulate:OBwidth:LIMit[:TEST] ?
Example	CALC:OBW:LIM:FBL 50 kHz CALC:OBW:LIM:FBL? CALC:OBW:LIM OFF CALC:OBW:LIM?

Occupied Bandwidth Measurement
Meas Setup

Notes	You must be in the Spectrum Analysis mode, W-CDMA mode, cdma2000 mode, TD-SCDMA mode, ISDB-T mode, CMMB mode, LTE mode, LTE TDD mode, 1xEVDO mode or WIMAX OFDMA mode to use this command. Use:INSTrument:SElect to set the mode.
Preset	SA, WCDMA: 5 MHz C2K: 1.48 MHz WIMAX OFDMA: 10MHz TD-SCDMA: 1.6MHz 1xEVDO: 1.48MHz ISDB-T: 5.7MHz CMMB: 7.512MHz LTE, LTETDD: 5 MHz BLUETOOTH:1 MHz SA: OFF WCDMA, WIMAX OFDMA, TD-SCDMA, 1xEVDO, ISDB-T, CMMB, LTE, LTETDD: ON
State Saved	Saved in instrument state.
Min	1 kHz
Max	Hardware Dependent: Option 503 = 3.7 GHz Option 507 = 7.1 GHz Option 508 = 8.5 GHz Option 513 = 13.8 GHz Option 526 = 27.0 GHz
Initial S/W Revision	Prior to A.02.00
Modified at S/W Revision	A.03.00

Meas Preset

Restores all measurement parameters to their default values.

Key Path	Meas Setup
Mode	SA, WCDMA, C2K, WIMAX OFDMA, TD-SCDMA, 1xEVDO, ISDB-T, CMMB, LTE, LTETDD
Remote Command	:CONFigure:OBWidth
Example	CONF:OBW
Initial S/W Revision	Prior to A.02.00

Modified at S/W Revision	A.03.00
--------------------------	---------

Mode

See “[Mode](#)” on page 1123 in the section "Common Measurement Functions" for more information.

Mode Setup

See [“Mode Setup” on page 1141](#) in the section "Common Measurement Functions" for more information.

Peak Search

Places the selected marker on the trace point with the maximum y-axis value for that marker's trace. Pressing Peak Search with the selected marker off causes the selected marker to be set to Normal, then a peak search is immediately performed.

Key Path	Front panel key
Mode	SA, WCDMA, C2K, WIMAX OFDMA, TD-SCDMA, 1xEVDO, ISDB-T, CMMB, LTE, LTETDD
Remote Command	:CALCulate:OBwidth:MARKer [1] 2 3 4 5 6 7 8 9 10 11 12 :M AXimum
Example	CALC:OBW:MARK2:MAX
Initial S/W Revision	Prior to A.02.00
Modified at S/W Revision	A.03.00

Recall

See [“Recall” on page 153](#) in the section "Common Measurement Functions" for more information.

Restart

See “[Restart](#)” on page 1163 in the section "Common Measurement Functions" for more information.

Save

See [“Save” on page 170](#) in the section "Common Measurement Functions" for more information.

Single

See “[Single \(Single Measurement/Sweep\)](#)” on page 1169 in the section "Common Measurement Functions" for more information.

Source

See [“Source” on page 1171](#) in the section "Common Measurement Functions" for more information.

Span X Scale

Activates the Span function and displays the menu of span functions. The parameter values are measurement independent.

Key Path	Front-panel key
Initial S/W Revision	Prior to A.02.00

Span

Set the frequency of the occupied bandwidth span for the current measurement.

Key Path	Span X Scale
Mode	SA, WCDMA, C2K, WIMAX OFDMA, TD-SCDMA, 1xEVDO, ISDB-T, CMMB, LTE, LTETDD
Remote Command	[:SENSe] :OBWidth:FREQuency:SPAN <freq> [:SENSe] :OBWidth:FREQuency:SPAN?
Example	OBW:FREQ:SPAN 2.4 MHz OBW:FREQ:SPAN?
Couplings	When changing the Occupied Bandwidth Span, the Resolution Bandwidth and Video Bandwidth are set to AUTO to prevent the span from clipping.
Preset	SA: 3 MHz WCDMA: 10 MHz WIMAX OFDMA: 20MHz CDMA2K:2MHz TD-SCDMA: 4.8MHz 1xEVDO: 3.75MHz ISDB-T: 20MHz CMMB: 10MHz LTE, LTETDD: 20 MHz BLUETOOTH:2 MHz
State Saved	Saved in instrument state.
Min	100 Hz

Max	Hardware Dependent: Option 503 = 3.7 GHz Option 507 = 7.1 GHz Option 508 = 8.5 GHz Option 513 = 13.8 GHz Option 526 = 27.0 GHz
Backwards Compatibility SCPI	[:SENSe]:EBWidth:FREQuency:SPAN
Initial S/W Revision	Prior to A.02.00
Modified at S/W Revision	A.03.00

Full Span

Changes the Occupied Bandwidth Span to show the full frequency range of the analyzer. When using external mixing, it changes the displayed frequency span to the frequency range specified for the selected external mixing band.

Key Path	Span X Scale
Mode	SA, WCDMA, C2K, WIMAX OFDMA, ISDB-T, CMMB, LTE, LTETDD
Remote Command	[:SENSe] :OBWidth:FREQuency:SPAN:FULL
Example	OBW:FREQ:SPAN:FULL
Notes	You must be in the Spectrum Analysis mode, W-CDMA mode, ISDB-T mode, CMMB mode, LTE mode, LTE TDD mode, cdma2000 mode or WIMAX OFDMA mode to use this command. Use:INSTrument:SElect to set the mode.
Couplings	Selecting full span changes the measurement span value.
Initial S/W Revision	Prior to A.02.00
Modified at S/W Revision	A.03.00

Last Span

Changes the measurement frequency span to previous measurement span setting. If there is no existing previous span value then the span remains unchanged.

Key Path	Span X Scale
Mode	SA, WCDMA, C2K, WIMAX OFDMA, ISDB-T, CMMB, LTE, LTETDD
Remote Command	[:SENSe] :OBWidth:FREQuency:SPAN:PREVIOUS
Example	OBW:FREQ:SPAN:PREV

Occupied Bandwidth Measurement
Span X Scale

Notes	You must be in the Spectrum Analysis mode, W-CDMA mode, ISDB-T mode, CMMB mode, LTE mode, LTE TDD mode, cdma2000 mode or WIMAX OFDMA mode to use this command. Use:INSTRument:SElect to set the mode.
Couplings	Selecting last span changes the measurement span value.
Initial S/W Revision	Prior to A.02.00
Modified at S/W Revision	A.03.00

Sweep/Control

Displays a menu of functions that enable you to set up and control the sweep time and source for the current measurement.

For details about this key, see [“Sweep/Control” on page 1181](#).

Key Path	Front-panel key
Initial S/W Revision	Prior to A.02.00

Sweep Time

Selects the length of time in which the spectrum analyzer sweeps the displayed frequency span. Additional overhead time, which impacts the sweep rate, is not calculated as part of the sweep time. In fact:

sweep rate = span/sweep time

update rate = 1/(sweep time + overhead)

sweep cycle time = sweep time + overhead

Sweep time is coupled to RBW and VBW, and is impacted by the number of sweep points, so changing those parameters may change the sweep time.

This is not available when the selected input is I/Q.

Key Path	Sweep/Control
Mode	SA, WCDMA, C2K, WIMAX OFDMA, TD-SCDMA, 1xEVDO, ISDB-T, CMMB, LTE, LTETDD
Remote Command	[:SENSE] :OBwidth:SWEep:TIME <time> [:SENSE] :OBwidth:SWEep:TIME? [:SENSE] :OBwidth:SWEep:TIME:AUTO OFF ON 0 1 [:SENSE] :OBwidth:SWEep:TIME:AUTO?
Example	OBW:SWE:TIME 50 ms OBW:SWE:TIME? OBW:SWE:TIME:AUTO ON OBW:SWE:TIME:AUTO?
Couplings	When you manually change the Sweep Time, this state automatically goes to ‘Man’.

Occupied Bandwidth Measurement
Sweep/Control

Preset	SA, WIMAX OFDMA, C2K, TD-SCDMA, 1xEVDO, ISDB-T, CMMB, LTE, LTETDD: Automatically Calculated WCDMA: 32.6 ms SA, WIMAX OFDMA, C2K, TD-SCDMA, 1xEVDO ISDB-T, CMMB, LTE, LTETDD: ON WCDMA: OFF
State Saved	Saved in instrument state.
Min	1 ms
Max	4000 s
Initial S/W Revision	Prior to A.02.00
Modified at S/W Revision	A.03.00

Sweep Setup

Accesses the sweep setup settings for the current measurement.

Key Path	Sweep/Control
Initial S/W Revision	Prior to A.02.00

Auto Sweep Time Rules

Switches the analyzer between normal and accuracy sweep states.

Setting Auto Sweep Time to Accy results in slower sweep times, usually about three times as long, but better amplitude accuracy for CW signals. The instrument amplitude accuracy specifications only apply when Auto Sweep Time is set to Accy.

Additional amplitude errors which occur when Auto Sweep Time is set to Norm are usually well under 0.1 dB, though this is not guaranteed. Because of the faster sweep times and still low errors, Norm is the preferred setting of Auto Sweep Time. Auto Sweep Time is set to Norm on a Preset or Auto Couple. This means that in the Preset or Auto Coupled state, instrument amplitude accuracy specifications do not apply.

Key Path	Sweep/Control, Sweep Setup
Mode	SA, WCDMA, C2K, WIMAX OFDMA, TD-SCDMA, 1xEVDO, ISDB-T, CMMB, LTE, LTETDD
Remote Command	[:SENSE] :OBWidth:SWEEp:TIME:AUTO:RULEs NORMAL ACCuracy [:SENSE] :OBWidth:SWEEp:TIME:AUTO:RULEs?
Example	OBW:SWE:TIME:AUTO:RUL NORM OBW:SWE:TIME:AUTO:RUL?
Notes	Set to Norm when Auto Couple is pressed or sent remotely.

Preset	NORMal
State Saved	Saved in instrument state.
Range	Norm Accy
Initial S/W Revision	Prior to A.02.00
Modified at S/W Revision	A.03.00

Pause

Pauses the measurement after the current data acquisition is complete.

When Paused, the label on the key changes to Resume. Pressing the Resume key resumes the measurement at the point where it had been paused.

See “Pause/Resume” on page 1193 for more information.

Key Path	Sweep/Control
Initial S/W Revision	Prior to A.02.00

Gate

Accesses a menu that enables you to control the gating function .

The Gate functionality is used to view signals best viewed by qualifying them with other events.

This function is not available when the selected input is I/Q.

See “Gate ” on page 1194 for more information.

Key Path	Sweep/Control
Initial S/W Revision	Prior to A.02.00

Points

Sets the number of points per sweep. The resolution of setting the sweep time depends on the number of points selected. The current value of points is displayed parenthetically, next to the sweep time in the lower-right corner of the display.

Key Path	Sweep/Control
Mode	SA, WCDMA, C2K, WIMAX OFDMA, TD-SCDMA, 1xEVDO, ISDB-T, CMMB, LTE, LTETDD
Remote Command	[:SENSe] :OBWidth:SWEep:POINts <integer> [:SENSe] :OBWidth:SWEep:POINts?
Example	OBW:SWE:POIN 1500 OBW:SWE:POIN?

Occupied Bandwidth Measurement
Sweep/Control

Notes	<p>This function is not available when signal identification is set to On (external mixing).</p> <p>Affected by:</p> <p>log sweep</p> <p>Grayed out in measurements that don't support swept</p> <p>Blanked in modes that do not support swept.</p> <p>Whenever the number of sweep points change:</p> <ul style="list-style-type: none">- All trace data is erased- Any traces with Update Off also go to Display Off (like going from View to Blank in the older analyzers)- Sweep time is re-quantized- Any limit lines that are on are updated- If averaging/hold is on, averaging/hold starts over
Couplings	Whenever the number of sweep points change, the sweep time is re-quantized.
Preset	1001
State Saved	Saved in instrument state.
Min	101
Max	20001
Initial S/W Revision	Prior to A.02.00
Modified at S/W Revision	A.03.00

Trace/Detector

Accesses a menu of functions that enable you to control the detectors for the current measurement.

Key Path	Front-panel key
Initial S/W Revision	Prior to A.02.00

Trace Type

Allows you to select the type of trace you want to you use for the current measurement.

The first page of this menu contains a 1-of-N selection of the trace type (Clear Write, Average, Max Hold, Min Hold) for the selected trace.

Key Path	Trace/Detector
Mode	SA, WCDMA, C2K, WIMAX OFDMA, TD-SCDMA, 1xEVDO, ISDB-T, CMMB, LTE, LTETDD
Remote Command	:TRACe:OBWidth:TYPE WRITe AVERAge MAXHold MINHold :TRACe:OBWidth:TYPE?
Example	TRAC:OBW:TYPE MINH TRAC:OBW:TYPE?
Notes	WRITe = Clear Write AVERAge = Average MAXHold = Maximum Hold MINHold = Minimum Hold
Couplings	When Detector setting is “Auto” (:SENSe]:OBWidth:DETeCTOR:AUTO?), Detector (:SENSe]:OBWidth:DETeCTOR[:FUNction]?) switches aligning with the switch of this parameter: “NORMal” with WRITe (Clear Write), “AVERAge” with AVERAge, “POSitive (peak)” with MAXHold, and “NEGative (peak)” with MINHold.
Preset	AVERAge
State Saved	Saved in instrument state.
Range	WRITe AVERAge MAXHold MINHold
Initial S/W Revision	Prior to A.02.00
Modified at S/W Revision	A.03.00

Detector

Accesses a menu of functions that enables you to control the detectors for the current measurement. The

Occupied Bandwidth Measurement Trace/Detector

following choices are available:

- Auto- the detector selected depends on marker functions, trace functions, average type, and the trace averaging function.
- Normal-the detector determines the peak of the CW-like signals, and it yields alternating maximums and minimums of noise-like signals. This is also referred to as Rosenfell detection.
- Average-the detector determines the average of the signal within the sweep points. The averaging method depends upon the Average Type selection (voltage, power or log scales).
- Peak (Positive)-the detector determines the maximum of the signal within the sweep points.
- Sample-the detector indicates the instantaneous level of the signal at the center of the sweep points represented by each display point.
- Negative Peak-the detector determines the minimum of the signal within the sweep points.

Key Path	Detector
Initial S/W Revision	Prior to A.02.00

Detector Selection

Allows you to select a specific detector for the current measurement. When the detector choice is Auto, the analyzer selects the detector. The selected detector depends on marker functions, trace functions, and trace averaging functions for the current measurement.

Key Path	Trace/Detector
Mode	SA, WCDMA, C2K, WIMAX OFDMA, TD-SCDMA, 1xEVDO, ISDB-T, CMMB, LTE, LTETDD
Remote Command	[:SENSe] :OBWidth:DETEctor[:FUNction] NORMal AVERage POSitive SAMPlE NEGative [:SENSe] :OBWidth:DETEctor[:FUNction]?
Example	OBW:DET NORM OBW:DET?

Notes	<p>When you manually select a detector (instead of selecting Auto), that detector is used regardless of other analyzer settings.</p> <p>The detector choices are:</p> <p>The Normal detector determines the peak of CW-like signals, and it yields alternating maximums and minimums of noise-like signals. This is also referred to as Rosenfell detection.</p> <p>The Average detector determines the average of the signal within the sweep points. The averaging method is Power Average (RMS).</p> <p>The Peak detector determines the maximum of the signal within the sweep points.</p> <p>The Sample detector indicates the instantaneous level of the signal at the center of the sweep points represented by each display point.</p> <p>The Negative Peak detector determines the minimum of the signal within the sweep points.</p>
Couplings	<p>When Detector setting is “Auto” (:SENSe]:OBWidth:DETEctor:AUTO?), Detector (:SENSe]:OBWidth:DETEctor[:FUNCTion]?) switches aligning with the switch of this parameter: “NORMal” with Clear Write, “AVERage” with AVERage, “POSitive (peak)” with MAXHold, and “NEGative (peak)” with MINHold.</p>
Preset	<p>AVERage</p> <p>ISDB-T: Peak</p> <p>BLUETOOTH: Peak</p>
State Saved	<p>Saved in instrument state.</p>
Range	<p>Normal Average Peak Sample Negative Peak</p>
Initial S/W Revision	<p>Prior to A.02.00</p>
Modified at S/W Revision	<p>A.03.00</p>

Auto

When the detector choice is Auto, the analyzer selects the detector. The selected detector depends on marker functions, trace functions, and trace averaging functions for the current measurement.

Key Path	Trace/Detector
Remote Command	<p>[:SENSe] :OBWidth:DETEctor:AUTO ON OFF 1 0</p> <p>[:SENSe] :OBWidth:DETEctor:AUTO?</p>
Example	<p>OBW:DET:AUTO ON</p> <p>OBW:DET:AUTO?</p>

Occupied Bandwidth Measurement
Trace/Detector

Couplings	When Detector setting is “Auto” ([:SENSe]:OBWidth:DETECTOR:AUTO?), Detector ([:SENSe]:OBWidth:DETECTOR[:FUNCTION]?) switches aligning with the switch of this parameter: “NORMAl” with Clear Write, “AVERAge” with AVERAge, “POSitive (peak)” with MAXHold, and “NEGative (peak)” with MINHold.
Preset	ON ISDB-T: OFF
State Saved	Saved in instrument state.
Initial S/W Revision	Prior to A.02.00
Modified at S/W Revision	A.03.00

Trigger

See [“Trigger” on page 1251](#) in the section "Common Measurement Functions" for information about all keys in this menu.

View/Display

Accesses a menu of functions that enable you to set the view and display parameters for the current measurement.

The following result descriptions are available:

Occupied Bandwidth

The occupied bandwidth result is $f_2 - f_1$, where f_1 and f_2 are calculated .

Total Power

The total power is the power integrated in the specified span setting.

Transmit Freq Error

The transmit freq error (transmit frequency error) result is calculated as the difference between $(f_2+f_1)/2$ and the tuned center frequency of the signal, where f_1 and f_2 are calculated.

x dB Bandwidth

The x dB result is a bandwidth measured between two points on the signal which are a certain number of dBs down from the highest signal point within the OBW Span. For example, If the 'x dB' parameter is set to -26dB, and the 'Occupied BW Span' is set to 10 MHz, then the maximum signal power level is first determined from the 10MHz wide trace sweep. Next, the two furthest frequencies below (x_{db_f1}) and above (x_{db_f2}) the frequency of the maximum level occurrence are found where the signal level is 26dB below the peak level. This calculation also uses linear interpolation to find the lower and upper carrier boundary point within the width of a sweep point (the span divided by the number of sweep points).

The x dB bandwidth is calculated to be $x_{db_f2} - x_{db_f1}$.

View

There is a single results view available for this measurement.

Spectrum View

NOTE An asterisk next to the x dB bandwidth value indicates the results may not have been determined with optimal analyzer settings. If this result (emission bandwidth) is your primary interest, select Meas Setup, Max Hold, On. Then change the detector mode to peak. Acquiring peak data ensures accuracy of the result.

For SA, WCDMA, C2K, 1xEVDO, WIMAX OFDMA mode:

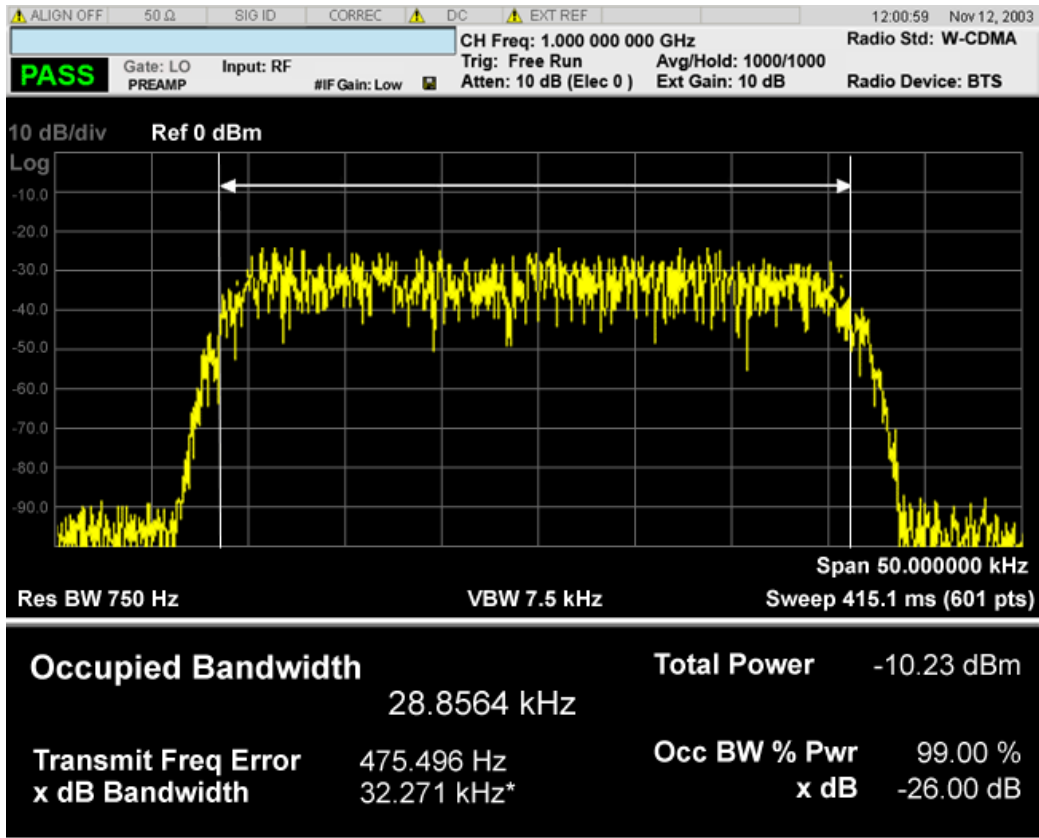

For TD-SCDMA mode only:

Occupied Bandwidth Measurement
View/Display

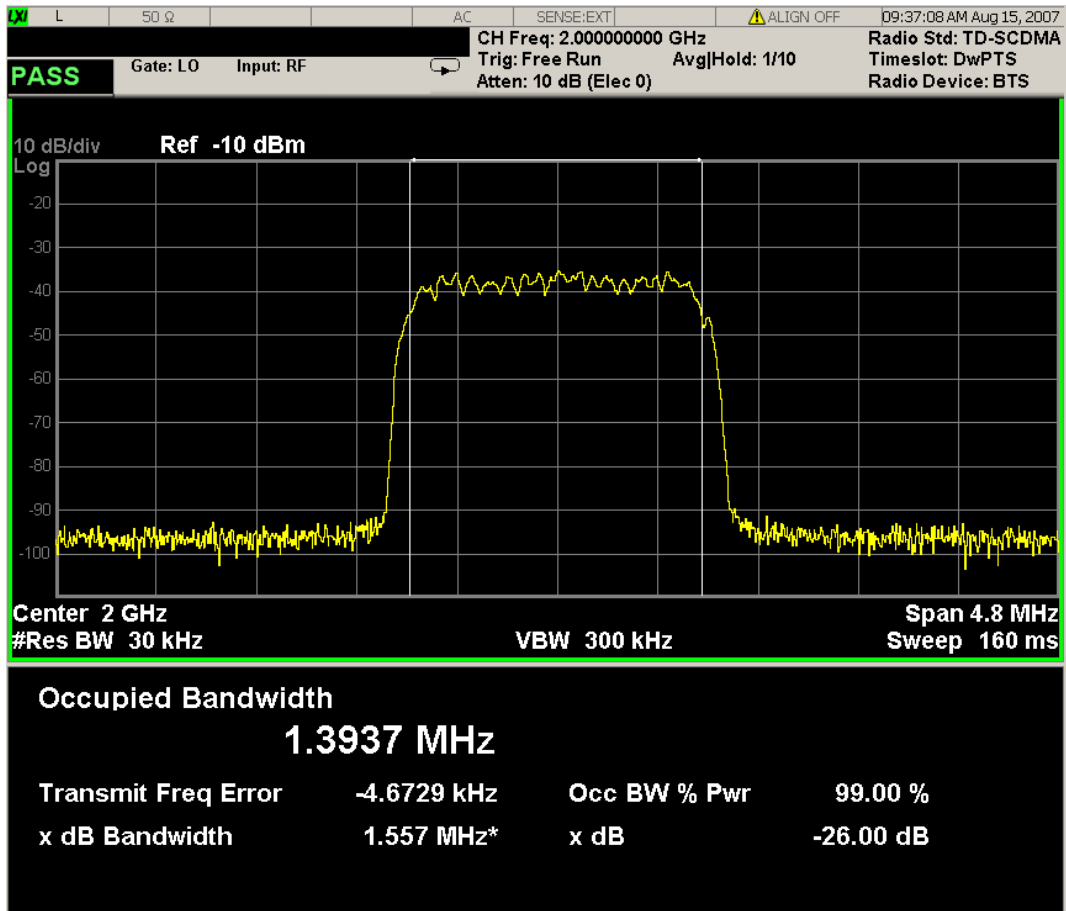

For Bluetooth Only:

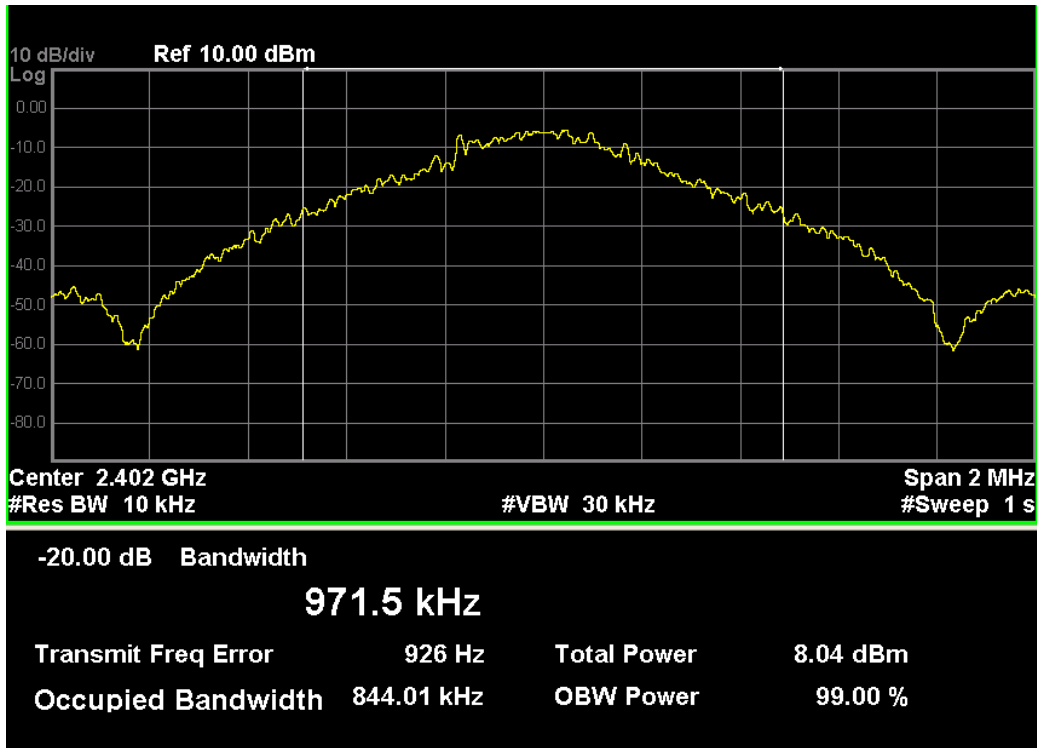

Key Path	Front-panel key
Initial S/W Revision	Prior to A.02.00

Display

Accesses a menu of functions that enable you to set the display parameters.

See “[Display](#)” on page 1313 in the section “Common Measurement Functions” for more information.

Key Path	View/Display
Initial S/W Revision	Prior to A.02.00

The monitor spectrum measurement is used as a quick, convenient means of looking at the entire spectrum. While the look and feel are similar to the Spectrum Analyzer mode, the functionality is greatly reduced for easy operation. The main purpose of the measurement is to show the spectrum. The default span should cover an appropriate frequency range of the application. For measurement results and views, see [“View/Display” on page 837](#).

This topic contains the following sections:

[“Measurement Commands for Monitor Spectrum” on page 791](#)

[“Remote Command Results for Monitor Spectrum Measurement” on page 791](#)

Measurement Commands for Monitor Spectrum

The following commands can be used to retrieve the measurement results:

```
:CONFigure:MONitor
```

```
:CONFigure:MONitor:NDEFault
```

```
:INITiate:MONitor
```

```
:FETCh:MONitor [n] ?
```

```
:READ:MONitor [n] ?
```

```
:MEASure:MONitor [n] ?
```

For more measurement related commands, see the SENSE subsystem, and the section [“Remote Measurement Functions” on page 1083](#).

Remote Command Results for Monitor Spectrum Measurement

n	Results Returned
n=1 (or not specified)	Returns trace1 data with comma separated floating numbers
n=2	Returns trace2 data with comma separated floating numbers
n=3	Returns trace3 data with comma separated floating numbers

Key Path	Meas
Initial S/W Revision	Prior to A.02.00

AMPTD Y Scale

Accesses a menu of functions that enable you to set the vertical scale parameters. These functions control how data on the vertical (Y) axis is displayed and control instrument settings that affect the vertical axis.

Key Path	Front-panel key
Initial S/W Revision	Prior to A.02.00

Ref Value

Sets the absolute power reference value. However, since the Auto Scaling is defaulted to On, this value is automatically determined by the measurement result. When you set a value manually, Auto Scaling automatically changes to Off.

Key Path	AMPTD Y Scale
Mode	All except SA and BASIC
Remote Command	:DISPlay:MONitor:VIEW[1]:WINDow[1]:TRACe:Y[:SCALE] :RLEVel <real> :DISPlay:MONitor:VIEW[1]:WINDow[1]:TRACe:Y[:SCALE] :RLEVel?
Example	DISP:MON:VIEW:WIND:TRAC:Y:RLEV 2.0 DISP:MON:VIEW:WIND:TRAC:Y:RLEV?
Couplings	When the Auto Scaling is On, this value is automatically determined by the measurement result. When you set a value manually, Auto Scaling automatically changes to Off.
Preset	10.00 dBm
State Saved	Saved in instrument state.
Min	-250.00 dBm
Max	250.00 dBm
Initial S/W Revision	Prior to A.02.00

Attenuation

Accesses a menu of functions that enable you to change the attenuation settings.

See AMPTD Y Scale, “[Attenuation](#)” on page 910 in the “Common Measurement Functions” section for more information.

Key Path	AMPTD Y Scale
----------	----------------------

Initial S/W Revision	Prior to A.02.00
----------------------	------------------

Scale/Div

Sets the logarithmic units per vertical graticule division on the display. However, since the Auto Scaling is defaulted to On, this value is automatically determined by the measurement result. When you set a value manually, Auto Scaling automatically changes to Off.

Key Path	AMPTD Y Scale
Mode	All except SA and BASIC
Remote Command	:DISPlay:MONitor:VIEW[1]:WINDow[1]:TRACe:Y[:SCALe] :PDIVision <rel_ampl> :DISPlay:MONitor:VIEW[1]:WINDow[1]:TRACe:Y[:SCALe] :PDIVision?
Example	DISP:MON:VIEW:WIND:TRAC:Y:PDIV 5.0 dB DISP:MON:VIEW:WIND:TRAC:Y:PDIV?
Couplings	When the Auto Scaling is On, this value is automatically determined by the measurement result. When you set a value manually, Auto Scaling automatically changes to Off.
Preset	10.00 dB
State Saved	Saved in instrument state.
Min	0.10 dB
Max	20.00 dB
Initial S/W Revision	Prior to A.02.00

Presel Center

See AMPTD Y Scale, “[Presel Center](#)” on page 926 in the “Common Measurement Functions” section for more information.

Presel Adjust

See AMPTD Y Scale, “[Preselector Adjust](#)” on page 927 in the “Common Measurement Functions” section for more information.

μW Path Control

The **μW Path Control** functions include the **μW Preselector Bypass** (Option MPB) and **Low Noise Path** (Option LNP) controls in the High Band path circuits.

See μ“[μW Path Control](#)” on page 935 under AMPTD Y Scale in the "Common Measurement Functions" section for more information.

Internal Preamp

Accesses a menu of functions that enable you to control the internal preamplifiers.

See AMPTD Y Scale, “[Internal Preamp](#)” on page 939 in the “Common Measurement Functions” section for more information.

Key Path	AMPTD Y Scale
Initial S/W Revision	Prior to A.02.00

Ref Position

Positions the reference level at the top, center or bottom of the Y Scale display. Changing the reference position does not change the reference level value.

Key Path	AMPTD Y Scale
Mode	All except SA and BASIC
Remote Command	:DISPlay:MONitor:VIEW[1]:WINDow[1]:TRACe:Y[:SCALE] :RPOSition TOP CENTer BOTTom :DISPlay:MONitor:VIEW[1]:WINDow[1]:TRACe:Y[:SCALE] :RPOSition?
Example	DISP:MON:VIEW:WIND:TRAC:Y:RPOS CENT DISP:MON:VIEW:WIND:TRAC:Y:RPOS?
Preset	TOP
State Saved	Saved in instrument state.
Range	Top Ctr Bot
Initial S/W Revision	Prior to A.02.00

Auto Scaling

Toggles the Auto Scaling function between On and Off.

Key Path	AMPTD Y Scale
Mode	All except SA and BASIC
Remote Command	:DISPlay:MONitor:VIEW[1]:WINDow[1]:TRACe:Y[:SCALE] :COUPle 0 1 OFF ON :DISPlay:MONitor:VIEW[1]:WINDow[1]:TRACe:Y[:SCALE] :COUPle?
Example	DISP:MON:VIEW:WIND:TRAC:Y:COUP ON DISP:MON:VIEW:WIND:TRAC:Y:COUP?

Couplings	<p>When Auto Scaling is On, and the Restart front-panel key is pressed, this function automatically determines the scale per division and reference values based on the measurement results.</p> <p>When you set a value to either Scale/Div or Ref Value manually, Auto Scaling automatically changes to Off.</p>
Preset	ON
State Saved	Saved in instrument state.
Range	On Off
Initial S/W Revision	Prior to A.02.00

Auto Couple

See “[Auto Couple](#)” on page 943 in the section "Common Measurement Functions" for more information.

BW

Accesses a menu that enables you to specify the resolution bandwidth functions that control the bandwidth and filter selection.

Key Path	Front-panel key
Initial S/W Revision	Prior to A.02.00

Res BW

Sets the resolution bandwidth for the current measurement. If an unavailable bandwidth is entered with the numeric keypad, the closest available bandwidth is selected.

Key Path	BW
Mode	All except SA and BASIC
Remote Command	[:SENSE]:MONitor:BANDwidth[:RESolution] <freq> [:SENSE]:MONitor:BANDwidth[:RESolution]? [:SENSE]:MONitor:BANDwidth[:RESolution]:AUTO OFF ON 0 1 [:SENSE]:MONitor:BANDwidth[:RESolution]:AUTO?
Example	MON:BAND 2.4 MHz MON:BAND? MON:BAND:AUTO ON MON:BAND:AUTO?

Monitor Spectrum
BW

Preset	<p>WCDMA: Automatically calculated WIMAX OFDMA: 100kHz C2K: Automatically calculated BLUETOOTH: Automatically calculated PN: Automatically calculated GSM/EDGE: Automatically calculated TD-SCDMA: Automatically calculated 1xEVDO: 30kHz DVB-T/H: 3.9kHz DTMB (CTTB): 3.9kHz ISDB-T: 3.9kHz CMMB: 3.9kHz LTE: 100 kHz LTETDD: 100 kHz WCDMA: ON WIMAX: OFF C2K: ON BLUETOOTH: ON PN: ON GSM/EDGE: ON TD-SCDMA: ON 1xEVDO: ON DVB-T/H: OFF DTMB (CTTB): OFF ISDB-T: OFF CMMB: OFF LTE:OFF LTETDD: OFF</p>
State Saved	Saved in instrument state.
Min	1.0 Hz
Max	8.0 MHz
Backwards Compatibility SCPI	[:SENSe]:MONitor:BWIDth[:RESolution]
Initial S/W Revision	Prior to A.02.00
Modified at S/W Revision	A.02.00

Modified at S/W Revision	A.03.00
--------------------------	---------

Video BW

Changes the analyzer post-detection filter.

Key Path	BW
Mode	All except SA and BASIC
Remote Command	[:SENSe]:MONitor:BANDwidth:VIDeo <bandwidth> [:SENSe]:MONitor:BANDwidth:VIDeo? [:SENSe]:MONitor:BANDwidth:VIDeo:AUTO ON OFF 1 0 [:SENSe]:MONitor:BANDwidth:VIDeo:AUTO?
Example	MON:BAND:VID 10 MHz MON:BAND:VID? MON:BAND:VID:AUTO OFF MON:BAND:VID:AUTO?

Monitor Spectrum
BW

Preset	<p>WCDMA: Automatically calculated WIMAX OFDMA: 1MHz C2K: Automatically calculated BLUETOOTH: Automatically calculated PN: Automatically calculated GSM/EDGE: Automatically calculated TD-SCDMA: Automatically calculated 1xEVDO: 300kHz DVB-T/H: 39kHz DTMB (CTTB): 39kHz ISDB-T: 39kHz CMMB: 39kHz LTE: 1 MHz LTETDD: 1 MHz WCDMA: ON WIMAX: OFF C2K: ON BLUETOOTH: ON PN: ON GSM/EDGE: ON TD-SCDMA: ON 1xEVDO: ON DVB-T/H: OFF DTMB (CTTB): OFF ISDB-T: OFF CMMB: OFF LTE:OFF LTETDD:OFF</p>
State Saved	Saved in instrument state.
Min	1 Hz
Max	50 MHz
Backwards Compatibility SCPI	[:SENSe]:MONitor:BWIDth:VIDeo
Initial S/W Revision	Prior to A.02.00
Modified at S/W Revision	A.02.00

Modified at S/W Revision	A.03.00
--------------------------	---------

VBW:3dB RBW

Selects the ratio between the video bandwidth and the equivalent 3 dB resolution bandwidth to be used for setting the VBW when VBW is in Auto.

Key Path	BW
Mode	All except SA and BASIC
Remote Command	[:SENSe] :MONitor: BANDwidth: VIDEo: RATio <real> [:SENSe] :MONitor: BANDwidth: VIDEo: RATio? [:SENSe] :MONitor: BANDwidth: VIDEo: RATio: AUTO OFF ON 0 1 [:SENSe] :MONitor: BANDwidth: VIDEo: RATio: AUTO?
Example	MON: BAND: VID: RAT 2 MON: BAND: VID: RAT? MON: BAND: VID: RAT: AUTO 0 MON: BAND: VID: RAT: AUTO?
Preset	1 ON
State Saved	Saved in instrument state.
Min	0.00001
Max	3000000
Backwards Compatibility SCPI	[:SENSe]: MONitor: BWIDth: VIDEo: RATio
Initial S/W Revision	Prior to A.02.00

Span:3dB RBW

Selects the ratio between span and resolution bandwidth.

The default setting is Auto with a Span:3 dB RBW ratio of 106:1. You can manually change this ratio by pressing the key, entering a new value, and pressing Enter.

Key Path	BW
Mode	All except SA and BASIC

Monitor Spectrum
BW

Remote Command	<pre>[:SENSe] :MONitor:FREQuency:SPAN:BANDwidth[:RESolution] :RATio <integer> [:SENSe] :MONitor:FREQuency:SPAN:BANDwidth[:RESolution] :RATio? [:SENSe] :MONitor:FREQuency:SPAN:BANDwidth[:RESolution] :RATio:AUTO OFF ON 0 1 [:SENSe] :MONitor:FREQuency:SPAN:BANDwidth[:RESolution] :RATio:AUTO?</pre>
Example	<pre>MON:FREQ:SPAN:BAND:RAT 200 MON:FREQ:SPAN:BAND:RAT? MON:FREQ:SPAN:BAND:RAT:AUTO ON MON:FREQ:SPAN:BAND:RAT:AUTO?</pre>
Preset	<pre>106 ON</pre>
State Saved	Saved in instrument state.
Min	2
Max	10000
Backwards Compatibility SCPI	[:SENSe]:MONitor:FREQuency:SPAN:BWIDth[:RESolution]:RATio
Initial S/W Revision	Prior to A.02.00
Modified at S/W Revision	A.04.00

Cont

See “[Cont \(Continuous Measurement/Sweep\)](#)” on page 957 in the section "Common Measurement Functions" for more information.

FREQ Channel

See “[FREQ Channel](#)” on page 959 in the section "Common Measurement Functions" for more information.

Input/Output

See [“Input/Output” on page 969](#) in the section "Common Measurement Functions" for more information.

Marker

Accesses a menu that enables you to select, set up and control the markers for the current measurement.

See the "Marker Functions" section for more information

Key Path	Front-panel key
Initial S/W Revision	Prior to A.02.00

Select Marker

Displays 12 markers available for selection.

Key Path	Marker
Initial S/W Revision	Prior to A.02.00

Marker Type

Sets the marker control mode to **Normal**, **Delta** or **Off**. If the selected marker is Off, pressing Marker sets it to Normal and places a single marker at the center of the display. At the same time, **Marker X Axis Value** appears on the Active Function area.

Key Path	Marker
Mode	All except SA and BASIC
Remote Command	:CALCulate:MONitor:MARKer [1] 2 3 4 5 6 7 8 9 10 11 12 :MODE POSition DELTA OFF :CALCulate:MONitor:MARKer [1] 2 3 4 5 6 7 8 9 10 11 12 :MODE?
Example	CALC:MON:MARK:MODE POS CALC:MON:MARK:MODE?
Notes	If the selected marker is Off, pressing Marker sets it to Normal and places it at the center of the screen on the trace determined by the Marker Trace rules. At the same time, Marker X Axis Value appears on the Active Function area. Default Active Function: the active function for the selected marker's current control mode. If the current control mode is Off, there is no active function and the active function is turned off. Active Function Display: the marker X axis value entered in the active function area displays the marker value to its full entered precision.
Preset	OFF
State Saved	Saved in instrument state.

Range	Normal Delta Off
Initial S/W Revision	Prior to A.02.00

Marker X Axis Value (Remote Command only)

Sets the marker X Axis value in the current marker X Axis Scale unit. It has no effect if the control mode is **Off**, but is the SCPI equivalent of entering an X value if the control mode is **Normal** or **Delta**.

Mode	All except SA and BASIC
Remote Command	:CALCulate:MONitor:MARKer [1] 2 3 4 5 6 7 8 9 10 11 12 :X <freq> :CALCulate:MONitor:MARKer [1] 2 3 4 5 6 7 8 9 10 11 12 :X?
Example	CALC:MON:MARK3:X 0 CALC:MON:MARK3:X?
Notes	If no suffix is sent, uses the fundamental units for the current marker X Axis Scale. If a suffix is sent that does not match the current marker X Axis Scale unit, an error “Invalid suffix” is generated. The query returns the marker’s absolute X Axis value if the control mode is Normal , or the offset from the marker’s reference marker if the control mode is Delta . The query is returned in the fundamental units for the current marker X Axis scale: Hz for Frequency and Inverse Time , seconds for Period and Time . If the marker is Off the response is not a number.
Preset	After a preset, all markers are turned OFF, so Marker X Axis Value query returns a not a number (NAN).
State Saved	No
Min	-9.9E+37
Max	9.9E+37
Initial S/W Revision	Prior to A.02.00

Marker X Axis Position (Remote Command only)

Sets the marker X position in trace points. It has no effect if the control mode is **Off**, but is the SCPI equivalent of entering a value if the control mode is **Normal** or **Delta** – except in trace points rather than X Axis Scale units. The entered value is immediately translated into the current X Axis Scale units for setting the value of the marker.

Mode	All except SA and BASIC
Remote Command	:CALCulate:MONitor:MARKer [1] 2 3 4 5 6 7 8 9 10 11 12 :X:POSition <real> :CALCulate:MONitor:MARKer [1] 2 3 4 5 6 7 8 9 10 11 12 :X:POSition?

Example	CALC:MON:MARK:X:POS 0 CALC:MON:MARK:X:POS?
Notes	The query returns the marker's absolute X Axis value in trace points if the control mode is Normal , or the offset from the marker's reference marker in trace points if the control mode is Delta . The value is returned as a real number, not an integer, corresponding to the translation from X Axis Scale units to trace points. If the marker is Off the response is not a number.
Preset	After a preset, all markers are turned OFF, so Marker X Axis Value query returns a not a number (NAN).
State Saved	No
Min	-9.9E+37
Max	9.9E+37
Initial S/W Revision	Prior to A.02.00

Marker Y Axis Value (Remote Command only)

Returns the marker Y Axis value in the current marker.

Mode	All except SA and BASIC
Remote Command	:CALCulate:MONitor:MARKer [1] 2 3 4 5 6 7 8 9 10 11 12 :Y?
Example	CALC:MON:MARK11:Y?
Preset	Result dependant on markers setup and signal source
Backwards Compatibility SCPI	:CALCulate:MONitor:MARKer[1] 2 3 4 5 6 7 8 9 10 11 12:FUNCTION:RESult ?
Initial S/W Revision	Prior to A.02.00

Properties

Accesses a menu that enables you to select the active marker, the reference marker and the trace for the current measurement.

Key Path	Marker
Initial S/W Revision	Prior to A.02.00

Select Marker

Displays 12 markers available for selection.

Key Path	Marker
Initial S/W Revision	Prior to A.02.00

Relative To

Selects the desired marker. The selected marker is relative to its reference marker

Key Path	Marker, Properties
Mode	All except SA and BASIC
Remote Command	:CALCulate:MONitor:MARKer [1] 2 3 4 5 6 7 8 9 10 11 12 :REFerence <integer> :CALCulate:MONitor:MARKer [1] 2 3 4 5 6 7 8 9 10 11 12 :REFerence?
Example	CALC:MON:MARK:REF 1 CALC:MON:MARK:REF?
Notes	A marker cannot be relative to itself so that choice is grayed out, and if sent from SCPI generates error -221: "Settings conflict; marker cannot be relative to itself." When queried a single value is returned (the specified marker number's relative marker).
Preset	2 3 4 5 6 7 8 9 10 11 12 1
State Saved	Saved in instrument state.
Min	1
Max	12
Initial S/W Revision	Prior to A.02.00

Marker Trace

Assigns the specified marker to the designated trace.

Key Path	Marker, Properties
Mode	All except SA and BASIC
Remote Command	:CALCulate:MONitor:MARKer [1] 2 3 4 5 6 7 8 9 10 11 12 :TRACe <integer> :CALCulate:MONitor:MARKer [1] 2 3 4 5 6 7 8 9 10 11 12 :TRACe?
Example	CALC:MON:MARK:TRAC 1 CALC:MON:MARK:TRAC?
Preset	1
State Saved	Saved in instrument state.
Min	1
Max	3

Initial S/W Revision	Prior to A.02.00
----------------------	------------------

Couple Markers

When this function is true, moving any marker causes an equal X Axis movement of every other marker which is not **Off**. By “equal X Axis movement” we mean that we preserve the difference between each marker’s X Axis value (in the fundamental x-axis units of the trace that marker is on) and the X Axis value of the marker being moved (in the same fundamental x-axis units).

Key Path	Marker
Mode	All except SA and BASIC
Remote Command	:CALCulate:MONitor:MARKer:COUPle[:STATe] ON OFF 1 0 :CALCulate:MONitor:MARKer:COUPle[:STATe]?
Example	CALC:MON:MARK:COUP ON CALC:MON:MARK:COUP?
Preset	OFF
State Saved	Saved in instrument state.
Range	On Off
Initial S/W Revision	Prior to A.02.00

All Markers Off

Turns off all markers on the current measurement.

Key Path	Marker
Mode	All except SA and BASIC
Remote Command	:CALCulate:MONitor:MARKer:AOFF
Example	CALC:MON:MARK:AOFF
Initial S/W Revision	Prior to A.02.00

Marker Function

Accesses special marker functions such as marker noise, and power in a specified bandwidth or time interval.

Key Path	Front-panel key
Initial S/W Revision	Prior to A.02.00

Select Marker

Selects one of the 12 available markers.

Key Path	Marker Function
Initial S/W Revision	Prior to A.02.00

Marker Function Type

Sets the marker control function type to, Marker Noise, Band/Interval Power, Band Interval Density, or Marker Function Off.

Key Path	Marker Function
Mode	All except SA and BASIC
Remote Command	:CALCulate:MONitor:MARKer [1] 2 3 4 5 6 7 8 9 10 11 12 :FUNctIon NOISe BPOwer BDENsity OFF :CALCulate:MONitor:MARKer [1] 2 3 4 5 6 7 8 9 10 11 12 :FUNctIon?
Example	CALC:MON:MARK:FUNC NOIS CALC:MON:MARK:FUNC?
Preset	OFF
State Saved	Saved in instrument state.
Range	Marker Noise Band/Interval Power Band Interval Density Marker Function Off
Initial S/W Revision	Prior to A.02.00

Band Adjust

Accesses a menu that enables you to set the frequency span width and the left and right edge, or time values, for the band or interval of the selected marker.

Key Path	Marker Function
----------	------------------------

Initial S/W Revision	Prior to A.02.00
----------------------	------------------

Band/Interval Span for Frequency Domain

Sets the width of the frequency span for the selected marker.

Key Path	Marker Function
Mode	All except SA and BASIC
Remote Command	:CALCulate:MONitor:MARKer [1] 2 3 4 5 6 7 8 9 10 11 12 :FUNction:BAND:SPAN <freq> :CALCulate:MONitor:MARKer [1] 2 3 4 5 6 7 8 9 10 11 12 :FUNction:BAND:SPAN?
Example	CALC:MON:MARK12:FUNC:BAND:SPAN 20 MHz CALC:MON:MARK12:FUNC:BAND:SPAN?
Couplings	Changing the Band/Interval Span necessarily changes the Band/Interval Left and Band/Interval Right values.
Preset	Depends on X axis range of selected Trace.
State Saved	Saved in instrument state.
Min	-9.9E+37
Max	9.9E+37
Initial S/W Revision	Prior to A.02.00

Band/Interval Left for Frequency Domain

Sets the left edge frequency or time value for the band of the selected marker.

Key Path	Marker Function
Mode	All except SA and BASIC
Remote Command	:CALCulate:MONitor:MARKer [1] 2 3 4 5 6 7 8 9 10 11 12 :FUNction:BAND:LEFT <freq> :CALCulate:MONitor:MARKer [1] 2 3 4 5 6 7 8 9 10 11 12 :FUNction:BAND:LEFT?
Example	CALC:MON:MARK12:FUNC:BAND:LEFT 20 GHz CALC:MON:MARK12:FUNC:BAND:LEFT?
Couplings	Changing the Band/Interval Left necessarily changes the Band/Interval Span and Band/Interval Right values.
Preset	Depends on X axis range of selected Trace.
State Saved	Saved in instrument state.
Min	-9.9E+37

Max	9.9E+37
Initial S/W Revision	Prior to A.02.00

Band/Interval Right for Frequency Domain

Sets the right edge frequency or time value for the band of the selected marker.

Key Path	Marker Function
Mode	All except SA and BASIC
Remote Command	:CALCulate:MONitor:MARKer [1] 2 3 4 5 6 7 8 9 10 11 12 :FUNction:BAND:RIGHT <freq> :CALCulate:MONitor:MARKer [1] 2 3 4 5 6 7 8 9 10 11 12 :FUNction:BAND:RIGHT?
Example	CALC:MON:MARK12:FUNC:BAND:RIGH 20 GHz CALC:MON:MARK12:FUNC:BAND:RIGH?
Couplings	Changing the Band/Interval Right necessarily changes the Band/Interval Left and Band/Interval Span values
Preset	Depends on X axis range of selected Trace.
State Saved	Saved in instrument state.
Min	-9.9E+37
Max	9.9E+37
Initial S/W Revision	Prior to A.02.00

Marker To

There is no 'Marker To' functionality supported in Monitor Spectrum. The front-panel key displays a blank menu key when pressed.

Key Path	Front-panel key
Initial S/W Revision	Prior to A.02.00

Meas

See [“Meas” on page 1083](#) in the section "Common Measurement Functions" for more information.

Meas Setup

Displays the setup menu for the current measurement. The measurement setup parameters include the number of measurement averages used to calculate the measurement result and the averaging mode. The setup menu also includes the option to reset the measurement settings to their factory defaults.

Key Path	Front-panel key
Initial S/W Revision	Prior to A.02.00

Avg/Hold Num

Specifies the number of measurement averages used when calculating the measurement result. The average is displayed at the end of each sweep.

After the specified number of average counts, the averaging mode (terminal control) setting determines the averaging action.

Key Path	Meas Setup
Mode	All except SA and BASIC
Remote Command	[:SENSE]:MONitor:AVERage:COUNT <integer> [:SENSe]:MONitor:AVERage:COUNT? [:SENSE]:MONitor:AVERage[:STATe] OFF ON 0 1 [:SENSe]:MONitor:AVERage[:STATe]?
Example	MON:AVER:COUN 25 MON:AVER:COUN? MON:AVER ON MON:AVER?
Preset	10 OFF
State Saved	Saved in instrument state.
Min	1
Max	1000
Initial S/W Revision	Prior to A.02.00

Avg Mode

Toggles the average mode between exponential (Exp) and Repeat.

Exp- continues measurement averaging, using the specified number of averages to compute each averaged value. The average is displayed at the end of each sweep.

Repeat- causes the measurement to reset the average counter each time the specified number of averages is reached.

Key Path	Meas Setup
Mode	All except SA and BASIC
Remote Command	[:SENSe] :MONitor:AVERage:TCONtrol EXPonential REPEAT [:SENSe] :MONitor:AVERage:TCONtrol?
Example	MON:AVER:TCON EXP MON:AVER:TCON?
Preset	EXPonential
State Saved	Saved in instrument state.
Range	ExpRepeat
Initial S/W Revision	Prior to A.02.00

Meas Preset

Restores all the measurement parameters to their default values.

Key Path	Meas Setup
Mode	All except SA and BASIC
Remote Command	:CONFigure:MONitor
Example	CONF:MON
Initial S/W Revision	Prior to A.02.00

Mode

See “[Mode](#)” on page 1123 in the section "Common Measurement Functions" for more information.

Mode Setup

See “[Mode Setup](#)” on page 1141 in the section "Common Measurement Functions" for more information.

Peak Search

There is no 'Peak Search' functionality supported in Monitor Spectrum. The front-panel key displays a blank menu key when pressed.

Key Path	Front-panel key
Initial S/W Revision	Prior to A.02.00

Recall

See [“Recall” on page 153](#) in the section "Common Measurement Functions" for more information.

Restart

See “[Restart](#)” on page 1163 in the section "Common Measurement Functions" for more information.

Save

See [“Save” on page 170](#) in the section "Common Measurement Functions" for more information.

Single

See “[Single \(Single Measurement/Sweep\)](#)” on page 1169 in the section "Common Measurement Functions" for more information.

Source

See [“Source” on page 1171](#) in the section "Common Measurement Functions" for more information.

Span X Scale

Accesses a menu of functions that enable you to set the horizontal scale parameters.

Key Path	Front-panel key
Initial S/W Revision	Prior to A.02.00

Span

Changes the frequency range symmetrically about the center frequency.

Key Path	Span X Scale
Mode	All except SA, BASIC
Remote Command	[:SENSE] :MONitor:FREQuency:SPAN <freq> [:SENSe] :MONitor:FREQuency:SPAN?
Example	MON:FREQ:SPAN 1 MHz MON:FREQ:SPAN?
Couplings	Changing the span causes the resolution bandwidth to change automatically, and affects data acquisition time.
Preset	WCDMA: 10.0 MHz WIMAX OFDMA: 50.0 MHz C2K: 2.5MHz PN: 1.0 MHz GSM/EDGE: 1.0 MHz TD-SCDMA: 3.2 MHz 1xEVDO: 2.0MHz DVB-T/H: 10.0MHz DTMB (CTTB): 10.0MHz ISDB-T: 10.0MHz CMMB: 10.0MHz LTE: 50 MHz LTETDD: 50 MHz IDEN: See the table below
State Saved	Saved in instrument state.
Min	10 Hz

Max	Hardware Dependent: Option 503 = 3.7 GHz Option 507 = 7.1GHz Option 508 = 8.5 GHz Option 513 = 13.8 GHz Option 526 = 27.0 GHz
Initial S/W Revision	Prior to A.02.00
Modified at S/W Revision	A.02.00
Modified at S/W Revision	A.03.00

IDEN Mode Span Preset for Monitor Spectrum

iDEN Slot Format	WiDEN Slot Format 25kHz	WiDEN Slot Format 50kHz	WiDEN Slot Format 75kHz	WiDEN Slot Format 100kHz	WiDEN Slot Format 50kHz Out
60kHz	60kHz	85kHz	110kHz	135kHz	135kHz

Full Span

Changes the Span to show the full frequency range of the analyzer.

Key Path	Span X Scale
Mode	All except SA and BASIC
Remote Command	[:SENSE] :MONitor:FREQuency:SPAN:FULL
Example	MON:FREQ:SPAN:FULL
Couplings	Sets the span to the full frequency range, and adjusts the center frequency accordingly.
Initial S/W Revision	Prior to A.02.00

Last Span

Changes the measurement span to the span setting of the previous measurement. If there is no existing previous span value, then the span remains unchanged.

Key Path	Span X Scale
Mode	All except SA and BASIC
Remote Command	[:SENSE] :MONitor:FREQuency:SPAN:PREVIOUS
Example	MON:FREQ:SPAN:PREV

Monitor Spectrum
Span X Scale

Couplings	Selecting last span changes the measurement span value.
Initial S/W Revision	Prior to A.02.00

Sweep/Control

Access a menu of functions that enable you to set up and control the sweep time for the current measurement

Key Path	Front-panel key
Initial S/W Revision	Prior to A.02.00

Sweep Time

Selects the length of time in which the spectrum analyzer sweeps the displayed frequency span. Additional overhead time is required by the analyzer. It impacts the sweep rate, but is not calculated as part of the sweep time. Reducing the sweep time increases the rate of sweeps.

Key Path	Sweep/Control
Mode	All except SA and BASIC
Remote Command	[:SENSe] :MONitor:SWEep:TIME <time> [:SENSe] :MONitor:SWEep:TIME? [:SENSe] :MONitor:SWEep:TIME:AUTO OFF ON 0 1 [:SENSe] :MONitor:SWEep:TIME:AUTO?
Example	MON:SWE:TIME 100 ms MON:SWE:TIME? MON:SWE:TIME:AUTO ON MON:SWE:TIME:AUTO?
Couplings	When the user manually changes the Sweep Time, this set automatically goes to 'Man'.
Preset	Automatically Calculated
State Saved	Saved in instrument state.
Min	1 ms
Max	4000 s
Initial S/W Revision	Prior to A.02.00
MIN/MAX/DEF Support	Yes

Pause

Pauses a measurement after the current data acquisition is complete. When Paused, the label on the key changes to Resume. Pressing Resume continues the measurement at the point where it had been paused.

See “Pause/Resume” on page 1193 under Sweep/Control in the "Common Measurement Functions" section for more information.

Key Path	Sweep/Control
Initial S/W Revision	Prior to A.02.00

Gate

Accesses a menu that enables you to control the gating function .

The Gate functionality is used to view signals best viewed by qualifying them with other events.

See “Gate ” on page 1194 in “common Measurement Functions” for more details.

Key Path	Sweep/Control
Initial S/W Revision	Prior to A.02.00

Points

Sets the number of points per sweep. The resolution of setting the sweep time depends on the number of points selected. If Preset is selected, the number of points per sweep defaults to 1001. The current value of points is displayed parenthetically, next to the sweep time in the lower right corner of the display.

Key Path	Sweep/Control
Mode	All except SA and BASIC
Remote Command	[:SENSE] :MONitor:SWEep:POINts <integer> [:SENSE] :MONitor:SWEep:POINts?
Example	:MON:SWE:POIN 1000 :MON:SWE:POIN?
Couplings	Whenever the number of sweep points changes, the sweep time is re-quantized.
Preset	1001
State Saved	Saved in instrument state.
Range	1 to 20001
Initial S/W Revision	Prior to A.02.00

Trace/Detector

Accesses a menu that enables you to control the display, storage, detection and manipulation of trace data. Each trace is comprised of a series of data points in which X and Y axis information is stored. The analyzer updates the information for the active trace with each sweep of the current measurement.

Key Path	Front-panel key
Initial S/W Revision	Prior to A.02.00

Select Trace

Allows you to select which trace you want to use for the current measurement. You can select one of three traces. Monitor Spectrum supports 3 traces, numbered 1 through 3.

Key Path	Trace/Detector
Mode	All except SA and BASIC
Preset	Trace 1
State Saved	The number of the selected trace is saved in Instrument State
Initial S/W Revision	Prior to A.02.00

Trace Type

Allows you to select the type of trace you want to you use for the current measurement. You can assign a trace type to one of the three available traces.

The first page of this menu contains a 1-of-N selection of the trace type (**Clear Write, Average, Max Hold, Min Hold**) for the selected trace.

Key Path	Trace/Detector
Mode	All except SA and BASIC
Remote Command	:TRACe [1] 2 3 :MONitor:TYPE WRITe AVERAge MAXHold MINHold :TRACe [1] 2 3 :MONitor:TYPE?
Example	TRAC:MON:TYPE WRIT TRAC:MON:TYPE?
Notes	WRITe = Clear Write AVERAge = Average MAXHold = Maximum Hold MINHold = Minimum Hold

Preset	WRITE
State Saved	Saved in instrument state.
Range	WRITE AVERAGE MAXHold MINHold for traces 1 through 3
Backwards Compatibility SCPI	:DISPlay:MONitor:VIEW:WINDow:TRACe[1] 2 3:TYPE
Initial S/W Revision	Prior to A.02.00

Update

Toggles a trace state between Update and Off. The Off selection makes the trace inactive (or a stored trace). This does not affect whether the trace is visible or not. Use the Display Show/Blank function to change the trace visibility.

Key Path	Trace/Detector
Mode	All except SA and BASIC
Remote Command	:TRACe [1] 2 3 :MONitor:UPDate [:STATE] ON OFF 0 1 :TRACe [1] 2 3 :MONitor:UPDate [:STATE] ?
Example	TRAC3:MON:UPD OFF TRAC3:MON:UPD?
Preset	ON
State Saved	Saved in instrument state.
Range	On Off (View)
Initial S/W Revision	Prior to A.02.00

Display

Controls the visibility of a trace. In **Blank**, traces do not display nor appear on printouts but are otherwise unaffected. They may be queried and markers may be placed on them

Key Path	Trace/Detector
Mode	All except SA and BASIC
Remote Command	:TRACe [1] 2 3 :MONitor:DISPlay [:STATE] ON OFF 0 1 :TRACe [1] 2 3 :MONitor:DISPlay [:STATE] ?
Example	TRAC:MON:DISP ON TRAC:MON:DISP?
Preset	ON OFF OFF
State Saved	Saved in instrument state.
Range	Show Blank

Initial S/W Revision	Prior to A.02.00
----------------------	------------------

Detector

Accesses a menu of functions that enable you to control the detectors for the current measurement. The following choices are available:

Auto — the detector selected depends on marker functions, trace functions, average type, and the trace averaging function.

- Normal — the detector determines the peak of the CW-like signals, and it yields alternating maximums and minimums of noise-like signals. This is also referred to as Rosenfell detection.
- Average — the detector determines the average of the signal within the sweep points. The averaging method depends upon the Average Type selection (voltage, power or log scales).
- Peak — the detector determines the maximum of the signal within the sweep points.
- Sample — the detector indicates the instantaneous level of the signal at the center of the sweep points represented by each display point.
- Negative Peak — the detector determines the minimum of the signal within the sweep points.

In swept analysis, the time interval of the data collection for the display sweep points also represents a frequency interval. In FFT analysis, the sweep points represent just a frequency interval. The detector determines the relationship between the spectrum computed by the FFT and the single data point displayed for the sweep points.

Key Path	Trace/Detector
Mode	All except SA and BASIC
Remote Command	[:SENSE] :MONitor:DETEctor:TRACe AVERAge NEGAtive NORMAl POSitive SAMPlE [:SENSE] :MONitor:DETEctor:TRACe?
Example	MON:DET:TRAC NORM MON:DET:TRAC?

Notes	<p>The query returns a name that corresponds to the detector type as shown below.</p> <p>String Returned</p> <p>Definition</p> <p>NORM Normal</p> <p>AVER Average</p> <p>POS Peak</p> <p>SAMP Sample</p> <p>NEG Negative Peak</p>
Couplings	When the Detector choice is Auto, the detector selected depends on average type.
Preset	NORMal
State Saved	Saved in instrument state.
Range	Normal Average(RMS) Peak Sample Negative Peak
Backwards Compatibility SCPI	[[:SENSE]:MONitor:DETECTOR[:FUNCTION]]
Initial S/W Revision	Prior to A.02.00

Auto

Sets the detector for the currently selected trace to Auto. When the detector choice is Auto, the analyzer selects the detector. The selected detector depends on marker functions, trace functions, and trace averaging functions for the current measurement.

Key Path	Trace/Detector Trace/Detector, Detector
Mode	All except SA and BASIC
Remote Command	[[:SENSE]:MONitor:DETECTOR:AUTO ON OFF 1 0 [:SENSE]:MONitor:DETECTOR:AUTO?
Example	MON:DET:AUTO OFF MON:DET:AUTO?
Couplings	When the Detector choice is Auto, the detector selected depends on average state and trace type.

Preset	ON
State Saved	Saved in instrument state.
Range	Auto Man
Initial S/W Revision	Prior to A.02.00

Clear Trace

Clears the selected trace from the display.

Key Path	Trace/Detector
Mode	All except SA and BASIC
Remote Command	:TRACe:MONitor:CLEar [TRACE1] TRACE2 TRACE3
Example	TRAC:MON:CLE
Initial S/W Revision	Prior to A.02.00

Mode	All except SA and BASIC
Remote Command	:DISPlay:MONitor:VIEW:WINDow:TRACe [1] 2 3 :CLEar
Example	DISP:MON:VIEW:WIND:TRAC:CLE
Initial S/W Revision	Prior to A.02.00

Clear All Traces

Clears all traces from the display.

Key Path	Trace/Detector
Mode	All except SA and BASIC
Remote Command	:TRACe:MONitor:CLEar:ALL
Example	TRAC:MON:CLE:ALL
Backwards Compatibility SCPI	:DISPlay:MONitor:VIEW:WINDow:TRACe:CLEar:ALL
Initial S/W Revision	Prior to A.02.00

Trigger

Accesses a menu of functions that enable you to select and control the trigger source for the current measurement.

See [“Trigger” on page 1251](#) in the "Common Measurement Functions" section for more information.

View/Display

Accesses a menu of functions that enable you to control certain functions related to the display of the analyzer.

There is a single trace view for this measurement.

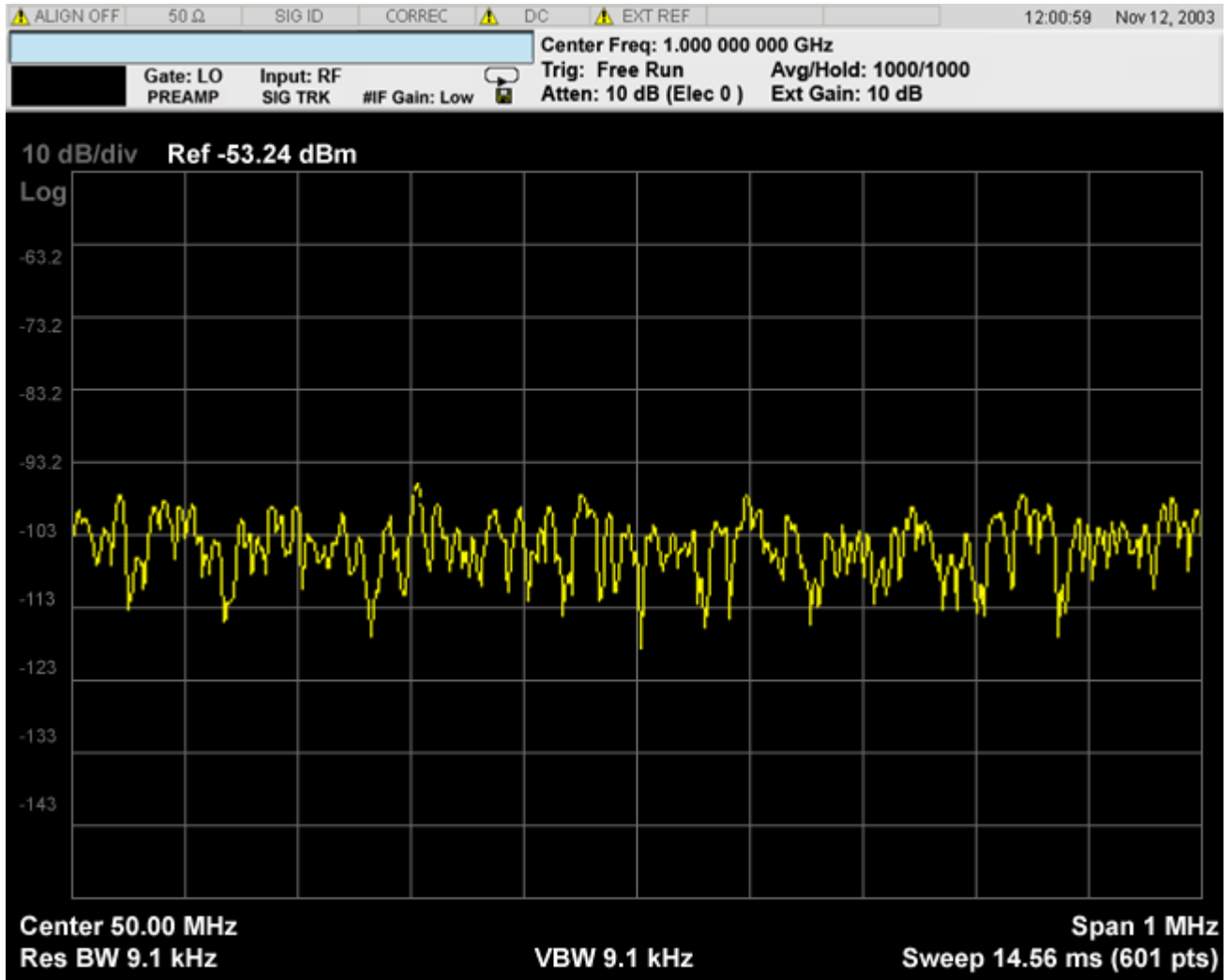

When the mode is CDMA1xEVDO, the view will be like

Monitor Spectrum
View/Display

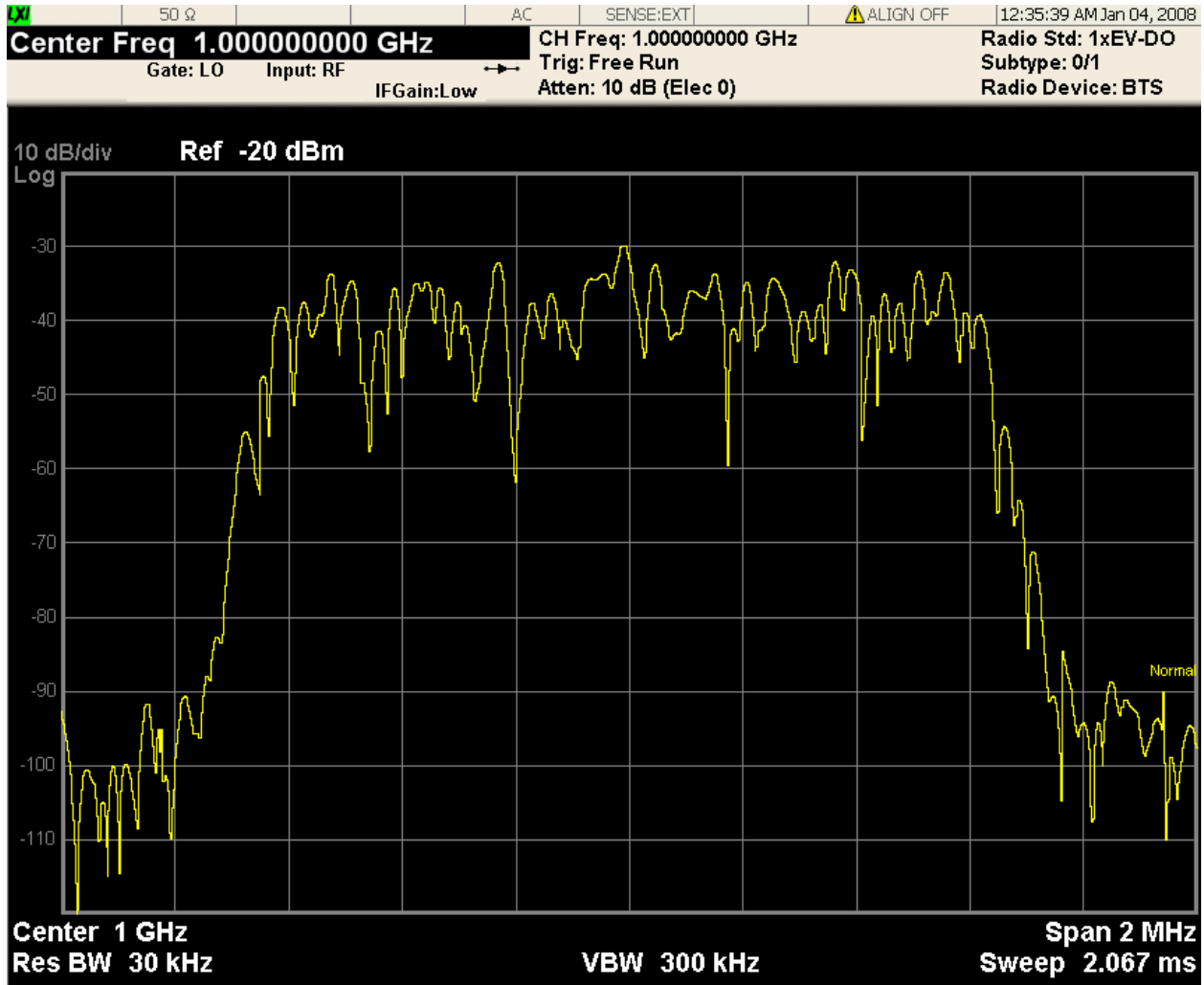

The measurement has no results, but has a number of features that make it flexible and simple to use.

Key Path	Front-panel key
Initial S/W Revision	Prior to A.02.00

Display

Accesses a menu of functions that enable you to set the display parameters.

See “[Display](#)” on page 1313 in the "Common Measurement Functions" section for more information.

Key Path	View/Display
Initial S/W Revision	Prior to A.02.00

The waveform measurement is a generic measurement for viewing the input signal waveforms in the time domain. This measurement represents how the instrument performs the zero span functionality found in traditional spectrum analyzers. For more details, see [“Waveform Measurement Description” on page 840](#) below.

This topic contains the following sections:

[“Measurement Commands for Waveform” on page 839](#)

[“Remote Command Results for Waveform Measurement” on page 839](#)

Measurement Commands for Waveform

The general functionality of CONFigure, INITiate, FETCh, MEASure, and READ are described at this section.

:CONFigure:WAVEform

:CONFigure:WAVEform:NDEFault

:INITiate:WAVEform

:FETCh:WAVEform [n]

:MEASure:WAVEform [n]

:READ:WAVEform [n]

For more measurement related commands, see the SENSE subsystem, and the section [“Remote Measurement Functions” on page 1083](#).

Remote Command Results for Waveform Measurement

The following table denotes the returned results from the FETCh|MEASure|READ commands:

n	Results Returned
0	Returns unprocessed I/Q trace data, as a series of trace point values, in volts. The I values are listed first in each pair, using the 0 through even-indexed values. The Q values are the odd-indexed values.

n	Results Returned
1	<p>Returns the following scalar results:</p> <ol style="list-style-type: none"> 1. Sample Time is a floating point number representing the time between samples when using the trace queries (n=0, 2, and so forth). 2. Mean Power is the mean power (in dBm). This is the power across the entire trace. If averaging is on, the power is for the latest acquisition. 3. Mean Power Averaged is the power (in dBm) for N averages, if averaging is on. This is the power across the entire trace. If averaging is on, the power is for the latest acquisition. If averaging is off, the value of the mean power averaged is the same as the value of the mean power. 4. Number of samples is the number of data points in the captured signal. This number is useful when performing a query on the signal (i.e. when n=0,2,etc.). 5. Peak-to-mean ratio has units of dB. This is the ratio of the maximum signal level to the mean power. Valid values are only obtained with averaging turned off. If averaging is on, the peak-to-mean ratio is calculated using the highest peak value, rather than the displayed average peak value. 6. Maximum value is the maximum of the most recently acquired data (in dBm). 7. Minimum value is the minimum of the most recently acquired data (in dBm).
2	<p>Returns trace point values of the entire captured signal envelope trace data. These data points are floating point numbers representing the power of the signal (in dBm). There are N data points, where N is the number of samples. The period between the samples is defined by the sample time.</p>

Waveform Measurement Description

Also available under basic Waveform measurement is an I/Q window, which shows the I and Q signal waveforms in parameters of voltage versus time to disclose the voltages which comprise the complex modulated waveform of a digital signal.

The waveform measurement can also be used to perform general purpose power measurements to a high degree of accuracy.

Key Path	Meas
Initial S/W Revision	Prior to A.02.00

AMPTD Y Scale

Accesses a menu of functions that enable you to set the vertical scale parameters.

Key Path	Front-panel key
Initial S/W Revision	Prior to A.02.00

Ref Value

Sets the absolute power reference value. However, since the Auto Scaling is defaulted to On, this value is automatically determined by the measurement result. When you set a value manually, Auto Scaling automatically changes to Off.

Ref Value (RF Envelope View)

Sets the Y Scale reference value (in dBm) when the RF Envelope View is active. By default, the measurement determines the reference value with Auto Scaling. Entering a reference value manually turns Auto Scaling off.

Key Path	AMPTD Y Scale
Mode	BASIC, PN, WCDMA, C2K, GSM, WIMAX OFDMA, TD-SCDMA, 1xEV-DO, DVB-T/H, DTMB (CTTB), ISDB-T, CMMB, LTE, LTETDD
Remote Command	:DISPlay:WAVEform:VIEW[1]:WINDow[1]:TRACe:Y[:SCALe]:RLEVel <ampl> :DISPlay:WAVEform:VIEW[1]:WINDow[1]:TRACe:Y[:SCALe]:RLEVel?
Example	DISP:WAV:VIEW:WIND:TRAC:Y:RLEV -50 dBm DISP:WAV:VIEW:WIND:TRAC:Y:RLEV?
Notes	You must be in the mode that includes Waveform measurement to use this command. Use INSTRument:SElect to set the mode.
Couplings	When the Auto Scaling is On, this value is automatically determined by the measurement result. When you set a value manually, Auto Scaling automatically changes to Off.
Preset	10.00 dBm
State Saved	Saved in instrument state.
Range	-250.00 dBm to 250.00 dBm
Initial S/W Revision	Prior to A.02.00
Modified at S/W Revision	A.03.00

Ref Value (I/Q Waveform View)

Sets the Y Scale reference value (in volts) when the I/Q Waveform View is active. By default, the measurement determines the reference value with Auto Scaling. Entering a reference value manually turns Auto Scaling off.

Key Path	AMPTD Y Scale
Mode	BASIC, PN, WCDMA, C2K, GSM, WIMAX OFDMA, TD-SCDMA, 1xEV-DO, DVB-T/H, DTMB (CTTB), ISDB-T, CMMB, LTE, LTETDD
Remote Command	:DISP:WAVEform:VIEW2:WINDow[1]:TRACe:Y[:SCALe]:RLEVe l <voltage> :DISP:WAVEform:VIEW2:WINDow[1]:TRACe:Y[:SCALe]:RLEVe l?
Example	DISP:WAV:VIEW2:WIND:TRAC:Y:RLEV 25 V DISP:WAV:VIEW2:WIND:TRAC:Y:RLEV?
Notes	You must be in a mode that includes the Waveform measurement to use this command. Use INSTRUMENT:SELEct to set the mode.
Couplings	When the Auto Scaling is On, this value is automatically determined by the measurement result. When you set a value manually, Auto Scaling automatically changes to Off.
Preset	0 V
State Saved	Saved in instrument state.
Min	-250 V
Max	250 V
Initial S/W Revision	Prior to A.02.00
Modified at S/W Revision	A.03.00

Attenuation

Accesses a menu of functions that enable you to change the attenuation settings. This key has a readback text that describes total attenuator value

This is only available when the selected input is RF.

See AMPTD Y Scale, “Attenuation” on page 910 in the section “Common Measurement Functions” for more information.

Key Path	AMPTD Y Scale
Initial S/W Revision	Prior to A.02.00

Range

Accesses a menu that enables you to change the baseband I/Q gain settings. This key has a readback text that describes gain range value. Refer to [“AMPTD Y Scale” on page 909](#) in the section “Common Measurement Functions” for more information.

Key Path	AMPTD Y Scale
Initial S/W Revision	Prior to A.02.00

Scale/Div

Sets the units per division of vertical scale in the logarithmic display. However, since the Auto Scaling is defaulted to On, this value is automatically determined by the measurement result. When you set a value manually, Auto Scaling automatically changes to Off.

Scale/Div (RF Envelope View)

Sets the scale per division for the RF Envelope result waveform (time domain) measurements in the graph window.

Key Path	AMPTD Y Scale
Mode	BASIC, PN, WCDMA, C2K, GSM, WIMAX OFDMA, TD-SCDMA, 1xEV-DO, DVB-T/H, DTMB (CTTB), ISDB-T, CMMB, LTE, LTETDD
Remote Command	:DISPlay:WAVEform:VIEW[1]:WINDow[1]:TRACe:Y[:SCALe]:PDI Vision <rel_ampl> :DISPlay:WAVEform:VIEW[1]:WINDow[1]:TRACe:Y[:SCALe]:PDI Vision?
Example	DISP:WAV:VIEW:WIND:TRAC:Y:PDIV 5 DISP:WAV:VIEW:WIND:TRAC:Y:PDIV?
Notes	You must be in a mode that includes the Waveform measurement to use this command. Use INSTRument:SElect to set the mode.
Couplings	When the Auto Scaling is On, this value is automatically determined by the measurement result. When you set a value manually, Auto Scaling automatically changes to Off.
Preset	10.00 dB
State Saved	Saved in instrument state.
Range	0.10 dB to 20.00 dB
Initial S/W Revision	Prior to A.02.00
Modified at S/W Revision	A.03.00

Scale/Div (I/Q Waveform View)

Sets the scale per division for the I/Q signal waveform graph.

Key Path	AMPTD Y Scale
Mode	BASIC, PN, WCDMA, C2K, GSM, WIMAX OFDMA, TD-SCDMA, 1xEV-DO, DVB-T/H, DTMB (CTTB), ISDB-T, CMMB, LTE, LTETDD
Remote Command	:DISPlay:WAVEform:VIEW2:WINDow[1]:TRACe:Y[:SCALE]:PDIVi sion <voltage> :DISPlay:WAVEform:VIEW2:WINDow[1]:TRACe:Y[:SCALE]:PDIVi sion?
Example	DISP:WAV:VIEW2:WIND:TRAC:Y:PDIV 25mV DISP:WAV:VIEW2:WIND:TRAC:Y:PDIV?
Notes	You must be in a mode that includes the Waveform measurement to use this command. Use INSTRument:SElect to set the mode.
Couplings	When the Auto Scaling is On, this value is automatically determined by the measurement result. When you set a value manually, Auto Scaling automatically changes to Off.
Preset	100.0 mV
State Saved	Saved in instrument state.
Min	1.0 nV
Max	20 V
Initial S/W Revision	Prior to A.02.00
Modified at S/W Revision	A.03.00

Presel Center

When this key is pressed, the centering of the preselector filter is adjusted to optimize the amplitude accuracy at the center frequency. This key does not appear in model numbers which do not contain an internal preselector (such as option 503 or all versions of the N9000A). Attempts to set via SCPI will be accepted without error. Queries will always return 0.

See “[Presel Center](#)” on page 926 in the section "Common Measurement Functions" for more information.

This is only available when the selected input is RF.

Key Path	AMPTD/Y Scale
Initial S/W Revision	Prior to A.02.00

Presel Adjust

Allows you to manually adjust the preselector filter frequency to optimize its response to the signal of interest. This function is only available when Presel Center is available.

This key does not appear in model numbers which do not contain an internal preselector (such as option 503 or all versions of the N9000A). Attempts to set via SCPI will be accepted without error. Queries will always return 0.

See [“Preselector Adjust” on page 927](#) in the section "Common Measurement Functions" for more information.

This key is only available when the selected input is RF.

Key Path	AMPTD/Y Scale
Initial S/W Revision	Prior to A.02.00

Internal Preamp

Accesses keys that control the internal preamps. Turning on the preamp gives a better noise figure, but a reduced TOI to noise floor dynamic range. You can optimize this setting for your particular measurement. The LowBand selection needs to show "(3.0 GHz)" for all versions of N9000A and "(3.6 GHz)" for the other models.

See [“Internal Preamp” on page 939](#) in the section "Common Measurement Functions" for more information.

This key is only available when the selected input is RF.

Key Path	AMPTD Y Scale
Initial S/W Revision	Prior to A.02.00

Ref Position

Positions the reference level at the top, center or bottom of the Y Scale display. Changing the reference position does not change the reference level value.

Ref Position (RF Envelope View)

Positions the reference level at the top, center or bottom of the Y Scale display. Changing the reference position does not change the reference level value.

Key Path	AMPTD Y Scale
Mode	BASIC, PN, WCDMA, C2K, GSM, WIMAX OFDMA, TD-SCDMA, 1xEV-DO, DVB-T/H, DTMB (CTTB), ISDB-T, CMMB, LTE, LTETDD

Waveform Measurement

AMPTD Y Scale

Remote Command	:DISPlay:WAVEform:VIEW[1]:WINDow[1]:TRACe:Y[:SCALe]:RPO Sition TOP CENTer BOTTom :DISPlay:WAVEform:VIEW[1]:WINDow[1]:TRACe:Y[:SCALe]:RPO Sition?
Example	DISP:WAV:VIEW:WIND:TRAC:Y:RPOS CENT DISP:WAV:VIEW:WIND:TRAC:Y:RPOS?
Notes	You must be in the mode that includes Waveform measurement to use this command. Use INSTRument:SElect to set the mode.
Preset	TOP
State Saved	Saved in instrument state.
Range	Top Ctr Bot
Initial S/W Revision	Prior to A.02.00
Modified at S/W Revision	A.03.00

Ref Position (I/Q Waveform View)

Positions the reference level at the top, center or bottom of the Y Scale display. Changing the reference position does not change the reference level value.

Key Path	AMPTD Y Scale
Mode	BASIC, PN, WCDMA, C2K, GSM, WIMAX OFDMA, TD-SCDMA, 1xEV-DO, DVB-T/H, DTMB (CTTB), ISDB-T, CMMB, LTE, LTETDD
Remote Command	:DISPlay:WAVEform:VIEW2:WINDow[1]:TRACe:Y[:SCALe]:RPOSi tion TOP CENTer BOTTom :DISPlay:WAVEform:VIEW2:WINDow[1]:TRACe:Y[:SCALe]:RPOSi tion?
Example	DISP:WAV:VIEW2:WIND:TRAC:Y:RPOS CENT DISP:WAV:VIEW2:WIND:TRAC:Y:RPOS?
Notes	You must be in the mode that includes Waveform measurement to use this command. Use INSTRument:SElect to set the mode.
Preset	CENT
State Saved	Saved in instrument state.
Range	Top Ctr Bot
Initial S/W Revision	Prior to A.02.00
Modified at S/W Revision	A.03.00

Auto Scaling

Toggles the Auto Scaling function between On and Off. When the **Restart** front-panel key is pressed,

this function automatically determines the scale per division and reference values based on the measurement results.

Key Path	AMPTD Y Scale
Mode	BASIC, PN, WCDMA, C2K, GSM, WIMAX OFDMA, TD-SCDMA, 1xEV-DO, DVB-T/H, DTMB (CTTB), ISDB-T, CMMB, LTE, LTETDD
Remote Command	:DISPlay:WAVEform:VIEW[1] 2:WINDow[1]:TRACe:Y[:SCALE]:COUPle 0 1 OFF ON :DISPlay:WAVEform:VIEW[1] 2:WINDow[1]:TRACe:Y[:SCALE]:COUPle?
Example	DISP:WAV:VIEW:WIND:TRAC:Y:COUP OFF DISP:WAV:VIEW:WIND:TRAC:Y:COUP?
Notes	You must be in the mode that includes Waveform measurement to use this command. Use INSTRument:SElect to set the mode.
Couplings	When Auto Scaling is On, upon pressing the Restart front-panel key, this function automatically switches the scale per division and reference values into the defaults. When the user sets a value to either Scale/Div or Ref Value manually, Auto Scaling automatically changes to Off.
Preset	OFF
State Saved	Saved in instrument state.
Range	On Off
Initial S/W Revision	Prior to A.02.00
Modified at S/W Revision	A.03.00

Auto Couple

See “[Auto Couple](#)” on page 943 in the section "Common Measurement Functions" for more information.

BW

Accesses a menu that enables you to control the information bandwidth functions of the instrument. You can also select the filter type for the measurement.

Key Path	Front-panel key
Initial S/W Revision	Prior to A.02.00

Digital IF BW

Enables you to set the Digital IF (formerly Info BW) bandwidth of the instrument.

Key Path	BW
Mode	BASIC, PN, WCDMA, C2K, GSM, WIMAX OFDMA, TD-SCDMA, 1xEV-DO, DVB-T/H, DTMB (CTTB), ISDB-T, CMMB, LTE, LTETDD
Remote Command	[:SENSe] :WAVeform:DIF:BANDwidth <freq> [:SENSe] :WAVeform:DIF:BANDwidth?
Example	WAV:DIF:BAND 1kHz WAV:DIF:BAND?
Notes	Max value depends on the IF Path Selection
Remote Command Notes	You must be in a mode that includes the Waveform measurements to use this command. Use INSTRument:SElect to set the mode.
Dependencies	For applications that have the IF Path Selection menu such as the BASIC mode, if IF Path Auto is OFF, the maximum value depends on which IF Path is currently selected. If 10 MHz, 25 MHz, 40 MHz, or 140 MHz paths are selected, the maximum value of this parameter will be 10, 25, 40 or 140 MHz, respectively. If IF Path Auto is ON, the maximum value will be the maximum Digital IF BW available in the instrument regardless of the current IF Path Selection. For example, say that the instrument had the options B25, B40 and B1X installed. The maximum available Digital IF BW of the instrument is 140 MHz. Thus, if IF Path Auto is ON and IF Path Selection is 25 MHz, the maximum Digital IF BW is not limited to 25 MHz but is 140 MHz.

Preset	All except the following list: 100 kHz Basic: 1 MHz GSM/EDGE: 510kHz TDSCDMA: 1.3MHZ 1xEVDO: 1.3MHz DVB-T/H: 8.0MHz DTMB (CTTB): 8.0MHz ISDB-T: 6.0MHz CMMB: 8.0MHz
State Saved	Saved in instrument state.
Min	10 Hz
Max	Hardware Dependent: RF Input: No Option = 10 MHz Option B25 = 25 MHz Option B40 = 40 MHz Option B1X = 140 MHz I/Q Input: No Option = 10 MHz per channel (20 MHz for I+jQ) Option B25 = 25 MHz per channel (50 MHz for I+jQ) Option S40 = 40 MHz per channel (80 MHz for I+jQ)
Backwards Compatibility SCPI	[:SENSE] :WAVEform: BANDwidth [:RESolution] [:SENSe]:WAVEform:BWIDth[:RESolution]
Initial S/W Revision	Prior to A.02.00
Modified at S/W Revision	A.03.00

Filter Type

Selects the type of bandwidth filter that is used.

Besides the Gaussian filter shape, a variety of other filter types are available with variable alpha settings for maximum control over the filter shape..

Key Path	BW
Mode	BASIC, PN, WCDMA, C2K, GSM, WIMAX OFDMA, TD-SCDMA, 1xEV-DO, DVB-T/H, DTMB (CTTB), ISDB-T, CMMB, LTE, LTETDD

Remote Command	[:SENSe]:WAVeform:DIF:FILTer:TYPE GAUSSian FLATtop [:SENSe]:WAVeform:DIF:FILTer:TYPE? (With DIF40 and/or WBDIF) [:SENSe]:WAVeform:DIF:FILTer:TYPE GAUSSian FLATtop SNYQuist RSNYquist RCOSine RRCosine [:SENSe]:WAVeform:DIF:FILTer:TYPE?
Example	WAV:DIF:FILT:TYPE GAUS WAV:DIF:FILT:TYPE?
Remote Command Notes	You must be in a mode that includes the Waveform measurements to use this command. Use INSTRument:SElect to set the mode.
Dependencies	Gaussian and Flattop are available in all DIF configurations. For the other filter types, the filters are only available with Pxa or when Option B40 is installed.
Preset	BASIC with B40 or B1X : FLATtop All other apps: GAUSSian
State Saved	Saved in instrument state.
Range	Gaussian FlatTop (With Digital IF and/or Option B40 or B1X) Gaussian Flattop Short nyquist Root Short Nquist Raised Cosine Root RaisedCosine
Backwards Compatibility SCPI	[:SENSe]:WAVeform:BANDwidth:SHAPE [:SENSe]:WAVeform:BWIDth:SHAPE [:SENSe]:WAVeform:BANDwidth BWIDth[:RESolution]:TYPE
Initial S/W Revision	Prior to A.02.00
Modified at S/W Revision	A.03.00

Filter Type Bwcc

This parameter is strictly for Bwcc purposes.

Remote Command	[:SENSe]:WAVeform:WBIF:FILTer[:TYPE] GAUSSian NONE NYQuist RNYQuist RCOSine RRCosine [:SENSe]:WAVeform:WBIF:FILTer[:TYPE]?
Preset	BASIC with B40 or B1X : FLATtop All other apps: GAUSSian

Gaussian

With a Pxa or Option B40, the capability for arbitrary Digital IF bandwidths is available. However, for instruments without the Digital IF or the Option B40 or B1X board, the selectable Gaussian filter bandwidths are predetermined in the following list. There are 160 Info BWs (RBWs). They are arranged in a 24-per-decade sequence from 1 Hz through 3 MHz, plus the 4, 5, 6 and 8 MHz settings.

The table in the section [“Gaussian filters” on page 853](#) lists all 160 Gaussian filter types.

Gaussian filters

Normal (-3 dB)	-6 dB	Noise	Impulse
1.0 Hz	1.41 Hz	1.06 Hz	1.49 Hz
1.1 Hz	1.55 Hz	1.16 Hz	1.63 Hz
1.2 Hz	1.69 Hz	1.27 Hz	1.77 Hz
1.3 Hz	1.83 Hz	1.37 Hz	1.92 Hz
1.5 Hz	2.11 Hz	1.59 Hz	2.22 Hz
1.6 Hz	2.25 Hz	1.69 Hz	2.37 Hz
1.8 Hz	2.53 Hz	1.90 Hz	2.66 Hz
2.0 Hz	2.81 Hz	2.12 Hz	2.96 Hz
2.2 Hz	3.09 Hz	2.33 Hz	3.25 Hz
2.4 Hz	3.38 Hz	2.54 Hz	3.55 Hz
2.7 Hz	3.80 Hz	2.86 Hz	3.99 Hz
3.0 Hz	4.22 Hz	3.17 Hz	4.44 Hz
3.3 Hz	4.64 Hz	3.49 Hz	4.88 Hz
3.6 Hz	5.06 Hz	3.81 Hz	5.32 Hz
3.9 Hz	5.49 Hz	4.12 Hz	5.77 Hz
4.3 Hz	6.05 Hz	4.55 Hz	6.36 Hz
4.7 Hz	6.61 Hz	4.97 Hz	6.95 Hz
5.1 Hz	7.17 Hz	5.39 Hz	7.54 Hz
5.6 Hz	7.87 Hz	5.92 Hz	8.27 Hz
6.2 Hz	8.72 Hz	6.56 Hz	9.17 Hz
6.8 Hz	9.55 Hz	7.18 Hz	10.0 Hz
7.5 Hz	10.5 Hz	7.93 Hz	11.1 Hz
8.2 Hz	11.5 Hz	8.66 Hz	12.1 Hz
9.1 Hz	12.8 Hz	9.64 Hz	13.5 Hz
10 Hz	14.0 Hz	10.6 Hz	14.8 Hz
11 Hz	15.4 Hz	11.6 Hz	16.2 Hz
12 Hz	16.9 Hz	12.7 Hz	17.7 Hz
13 Hz	18.3 Hz	13.7 Hz	19.2 Hz
15 Hz	21.1 Hz	15.9 Hz	22.2 Hz

Normal (-3 dB)	-6 dB	Noise	Impulse
16 Hz	22.5 Hz	16.9 Hz	23.7 Hz
18 Hz	25.3 Hz	19.1 Hz	26.6 Hz
20 Hz	28.1 Hz	21.1 Hz	29.5 Hz
22 Hz	30.9 Hz	23.2 Hz	32.5 Hz
24 Hz	33.8 Hz	25.4 Hz	35.5 Hz
27 Hz	38.0 Hz	28.6 Hz	40.0 Hz
30 Hz	42.3 Hz	31.8 Hz	44.5 Hz
33 Hz	46.3 Hz	34.8 Hz	48.7 Hz
36 Hz	50.7 Hz	38.1 Hz	53.3 Hz
39 Hz	54.9 Hz	41.3 Hz	57.7 Hz
43 Hz	60.5 Hz	45.5 Hz	63.6 Hz
47 Hz	66.1 Hz	49.7 Hz	69.5 Hz
51 Hz	71.7 Hz	53.9 Hz	75.3 Hz
56 Hz	78.9 Hz	59.3 Hz	83.0 Hz
62 Hz	87.3 Hz	65.6 Hz	91.7 Hz
68 Hz	95.5 Hz	71.8 Hz	100 Hz
75 Hz	106 Hz	79.4 Hz	111 Hz
82 Hz	115 Hz	86.8 Hz	121 Hz
91 Hz	128 Hz	96.4 Hz	135 Hz
100 Hz	141 Hz	106 Hz	148 Hz
110 Hz	154 Hz	116 Hz	162 Hz
120 Hz	169 Hz	127 Hz	178 Hz
130 Hz	183 Hz	137 Hz	192 Hz
150 Hz	211 Hz	159 Hz	222 Hz
160 Hz	225 Hz	169 Hz	237 Hz
180 Hz	253 Hz	190 Hz	266 Hz
200 Hz	281 Hz	211 Hz	295 Hz
220 Hz	309 Hz	232 Hz	325 Hz
240 Hz	337 Hz	254 Hz	355 Hz
270 Hz	380 Hz	286 Hz	400 Hz

Normal (-3 dB)	-6 dB	Noise	Impulse
300 Hz	422 Hz	317 Hz	444 Hz
330 Hz	463 Hz	348 Hz	487 Hz
360 Hz	507 Hz	381 Hz	533 Hz
390 Hz	550 Hz	413 Hz	578 Hz
430 Hz	605 Hz	455 Hz	636 Hz
470 Hz	662 Hz	498 Hz	696 Hz
510 Hz	718 Hz	540 Hz	755 Hz
560 Hz	789 Hz	593 Hz	829 Hz
620 Hz	872 Hz	655 Hz	916 Hz
680 Hz	958 Hz	720 Hz	1.01 kHz
750 Hz	1.06 kHz	794 Hz	1.11 kHz
820 Hz	1.15 kHz	866 Hz	1.21 kHz
910 Hz	1.28 kHz	964 Hz	1.35 kHz
1.0 kHz	1.41 kHz	1.06 kHz	1.48 kHz
1.1 kHz	1.55 kHz	1.17 kHz	1.63 kHz
1.2 kHz	1.69 kHz	1.27 kHz	1.78 kHz
1.3 kHz	1.83 kHz	1.38 kHz	1.93 kHz
1.5 kHz	2.11 kHz	1.59 kHz	2.22 kHz
1.6 kHz	2.26 kHz	1.70 kHz	2.37 kHz
1.8 kHz	2.54 kHz	1.91 kHz	2.67 kHz
2.0 kHz	2.82 kHz	2.12 kHz	2.96 kHz
2.2 kHz	3.10 kHz	2.33 kHz	3.26 kHz
2.4 kHz	3.38 kHz	2.54 kHz	3.56 kHz
2.7 kHz	3.80 kHz	2.86 kHz	4.00 kHz
3.0 kHz	4.23 kHz	3.18 kHz	4.44 kHz
3.3 kHz	4.65 kHz	3.49 kHz	4.89 kHz
3.6 kHz	5.06 kHz	3.81 kHz	5.32 kHz
3.9 kHz	5.48 kHz	4.12 kHz	5.76 kHz
4.3 kHz	6.07 kHz	4.56 kHz	6.38 kHz
4.7 kHz	6.62 kHz	4.98 kHz	6.96 kHz

Normal (-3 dB)	-6 dB	Noise	Impulse
5.1 kHz	7.16 kHz	5.38 kHz	7.53 kHz
5.6 kHz	7.87 kHz	5.92 kHz	8.27 kHz
6.2 kHz	8.74 kHz	6.57 kHz	9.18 kHz
6.8 kHz	9.58 kHz	7.20 kHz	10.1 kHz
7.5 kHz	10.5 kHz	7.92 kHz	11.1 kHz
8.2 kHz	11.5 kHz	8.66 kHz	12.1 kHz
9.1 kHz	12.8 kHz	9.64 kHz	13.5 kHz
10 kHz	14.1 kHz	10.6 kHz	14.8 kHz
11 kHz	15.4 kHz	11.6 kHz	16.2 kHz
12 kHz	16.9 kHz	12.7 kHz	17.8 kHz
13 kHz	18.3 kHz	13.7 kHz	19.2 kHz
15 kHz	21.2 kHz	15.9 kHz	22.3 kHz
16 kHz	22.4 kHz	16.8 kHz	23.5 kHz
18 kHz	25.2 kHz	19.0 kHz	26.5 kHz
20 kHz	28.4 kHz	21.3 kHz	29.8 kHz
22 kHz	31.2 kHz	23.4 kHz	32.8 kHz
24 kHz	33.8 kHz	25.4 kHz	35.6 kHz
27 kHz	38.1 kHz	28.7 kHz	40.1 kHz
30 kHz	42.1 kHz	31.7 kHz	44.3 kHz
33 kHz	46.8 kHz	35.2 kHz	49.2 kHz
36 kHz	50.1 kHz	37.7 kHz	52.7 kHz
39 kHz	54.8 kHz	41.2 kHz	57.6 kHz
43 kHz	61.1 kHz	46.0 kHz	64.3 kHz
47 kHz	66.2 kHz	49.8 kHz	69.6 kHz
51 kHz	72.3 kHz	54.3 kHz	76.0 kHz
56 kHz	79.5 kHz	59.8 kHz	83.6 kHz
62 kHz	86.3 kHz	64.9 kHz	90.8 kHz
68 kHz	96.5 kHz	72.6 kHz	101 kHz
75 kHz	106 kHz	79.7 kHz	111 kHz
82 kHz	114 kHz	86.0 kHz	120 kHz

Normal (-3 dB)	-6 dB	Noise	Impulse
91 kHz	129 kHz	97.3 kHz	136 kHz
100 kHz	140 kHz	105 kHz	147 kHz
110 kHz	154 kHz	116 kHz	162 kHz
120 kHz	169 kHz	127 kHz	178 kHz
130 kHz	182 kHz	137 kHz	192 kHz
150 kHz	210 kHz	158 kHz	221 kHz
160 kHz	223 kHz	168 kHz	235 kHz
180 kHz	253 kHz	190 kHz	266 kHz
200 kHz	280 kHz	211 kHz	295 kHz
220 kHz	308 kHz	232 kHz	324 kHz
240 kHz	336 kHz	253 kHz	353 kHz
270 kHz	380 kHz	286 kHz	400 kHz
300 kHz	420 kHz	316 kHz	441 kHz
330 kHz	467 kHz	352 kHz	491 kHz
360 kHz	506 kHz	380 kHz	532 kHz
390 kHz	550 kHz	414 kHz	578 kHz
430 kHz	599 kHz	451 kHz	629 kHz
470 kHz	660 kHz	497 kHz	693 kHz
510 kHz	715 kHz	538 kHz	750 kHz
560 kHz	786 kHz	592 kHz	826 kHz
620 kHz	867 kHz	653 kHz	912 kHz
680 kHz	952 kHz	717 kHz	1.00 MHz
750 kHz	1.05 MHz	791 kHz	1.10 MHz
820 kHz	1.14 MHz	859 kHz	1.19 MHz
910 kHz	1.27 MHz	960 kHz	1.34 MHz
1.0 MHz	1.40 MHz	1.06 MHz	1.47 MHz
1.1 MHz	1.53 MHz	1.15 MHz	1.61 MHz

Normal (-3 dB)	-6 dB	Noise	Impulse
1.2 MHz	1.66 MHz	1.26 MHz	1.75 MHz
1.3 MHz	1.80 MHz	1.36 MHz	1.89 MHz
1.5 MHz	2.06 MHz	1.56 MHz	2.17 MHz
1.6 MHz	2.19 MHz	1.66 MHz	2.29 MHz
1.8 MHz	2.51 MHz	1.91 MHz	2.63 MHz
2.0 MHz	2.75 MHz	2.10 MHz	2.88 MHz
2.2 MHz	3.00 MHz	2.30 MHz	3.14 MHz
2.4 MHz	3.30 MHz	2.54 MHz	3.45 MHz
2.7 MHz	3.63 MHz	2.81 MHz	3.78 MHz
3.0 MHz	4.09 MHz	3.18 MHz	4.22 MHz
4 MHz	5.30 MHz	4.23 MHz	5.30 MHz
5 MHz	5.78 MHz	4.81 MHz	5.41 MHz
6 MHz	6.31 MHz	5.50 MHz	5.82 MHz
8 MHz	8.07 MHz	7.21 MHz	6.90 MHz

Flattop

With a Pxa or Option B40, the capability for arbitrary Digital IF bandwidths is available. However, for instruments without the Digital IF or the Option B40 or B1X board, the selectable Flattop filter bandwidths are predefined in the following table. There are 134 Digital IF BWs (RBWs).

The table in the section “[Flattop Filters](#)” on page 859 lists all 134 Flattop filter types.

Flattop Filters

3.0 Hz	3.3 Hz	3.6 Hz	3.9 Hz
4.3 Hz	4.7 Hz	5.1 Hz	5.6 Hz
6.2 Hz	6.8 Hz	7.5 Hz	8.2 Hz
9.1 Hz	10 Hz	11 Hz	12 Hz
13 Hz	15 Hz	16 Hz	18 Hz
20 Hz	22 Hz	24 Hz	27 Hz
30 Hz	33 Hz	36 Hz	39 Hz
43 Hz	47 Hz	51 Hz	56 Hz
62 Hz	68 Hz	75 Hz	82 Hz
91 Hz	100 Hz	110 Hz	120 Hz
130 Hz	150 Hz	160 Hz	180 Hz
200 Hz	220 Hz	240 Hz	270 Hz
300 Hz	330 Hz	360 Hz	390 Hz
430 Hz	470 Hz	510 Hz	560 Hz
620 Hz	680 Hz	750 Hz	820 Hz
910 Hz	1.0 kHz	1.1 kHz	1.2 kHz
1.3 kHz	1.5 kHz	1.6 kHz	1.8 kHz
2.0 kHz	2.2 kHz	2.4 kHz	2.7 kHz
3.0 kHz	3.3 kHz	3.6 kHz	3.9 kHz
4.3 kHz	4.7 kHz	5.1 kHz	5.6 kHz
6.2 kHz	6.8 kHz	7.5 kHz	8.2 kHz
9.1 kHz	10 kHz	11 kHz	12 kHz
13 kHz	15 kHz	16 kHz	18 kHz
20 kHz	22 kHz	24 kHz	27 kHz
30 kHz	33 kHz	36 kHz	39 kHz
43 kHz	47 kHz	51 kHz	56 kHz
62 kHz	68 kHz	75 kHz	82 kHz
91 kHz	100 kHz	110 kHz	120 kHz
130 kHz	150 kHz	160 kHz	180 kHz
200 kHz	220 kHz	240 kHz	270 kHz

Waveform Measurement
BW

300 kHz	330 kHz	390 kHz	430 kHz
510 kHz	620 kHz	750 kHz	1.0 MHz
1.5 MHz	3.0 MHz	4 MHz	5 MHz
6 MHz	8 MHz		

Filter

This feature is only available with Pxa or when Option B40 is installed.

Key Path	BW
Mode	BASIC
Remote Command	[:SENSe]:WAVeform:DIF:FILTer:BANDwidth <freq> [:SENSe]:WAVeform:DIF:FILTer:BANDwidth? [:SENSe]:WAVeform:DIF:FILTer:BANDwidth:AUTO ON OFF 1 0 [:SENSe]:WAVeform:DIF:FILTer:BANDwidth:AUTO?
Example	WAV:DIF:FILT:BAND 1MHz WAV:DIF:FILT:BAND? WAV:DIF:FILT:BAND:AUTO 0 WAV:DIF:FILT:BAND:AUTO?
Notes	You must be in the IQ Analyzer (Basic) mode to use this command. Use INSTRument:SElect to set the mode.
Dependencies	This feature is only available with Pxa or when Option B40 is installed.
Couplings	Sets the same value as the current Digital IF BW value upon a preset or when Channel Filter Bandwidth Auto is ON.
Preset	Same value as Digital IF BW ON
State Saved	Saved in instrument state.
Min	10 Hz
Max	Clipped to the current Digital IF BW value.
Initial S/W Revision	A.04.00

Channel Filter Bandwidth Bwcc (Remote Command Only)

This is the backward compatibility command for Channel Filter Bandwidth.

Mode	BASIC
------	-------

Remote Command	[:SENSE] :WAVEform:WBIF:FILTer:BANDwidth <real> [:SENSE] :WAVEform:WBIF:FILTer:BANDwidth?
Example	WAV:WBIF:FILT:BAND 0.3 WAV:WBIF:FILT:BAND?
Notes	You must be in the IQ Analyzer (Basic) mode to use this command. Use INSTRument:SElect to set the mode.
Dependencies	This feature is only available with Pxa or when Option B40 is installed.
Couplings	The value is determined by the following equation. ChannelFilterBwBwcc = (ChannelFilterBw/(DigitalIFBw*OverSampleRatio))
Preset	0.8
State Saved	Saved in instrument state.
Min	0.01
Max	1.0
Initial S/W Revision	A.04.00

Channel Filter Alpha

Sets the filter alpha for the DIF filter. This feature is only available with Pxa or when Option B40 is installed.

Key Path	BW
Mode	BASIC
Remote Command	[:SENSE] :WAVEform:DIF:FILTer:ALPHa <real> [:SENSE] :WAVEform:DIF:FILTer:ALPHa?
Example	WAV:DIF:FILT:ALPH 0.5 WAV:DIF:FILT:ALPH?
Notes	You must be in the IQ Analyzer (Basic) mode to use this command. Use INSTRument:SElect to set the mode.
Dependencies	This feature is only available with Pxa or when Option B40 is installed.
Preset	0.2
State Saved	Saved in instrument state.
Min	0.01
Max	1.00
Backwards Compatibility SCPI	[:SENSe]:WAVEform:WBIF:FILTer:ALPHa

Cont

See “[Cont \(Continuous Measurement/Sweep\)](#)” on page 957 in the section "Common Measurement Functions" for more information.

FREQ Channel

See “[FREQ Channel](#)” on page 959 in the section “Common Measurement Functions” for more information.

Input/Output

See “[Input/Output](#)” on page 969 in the section "Common Measurement Functions" for more information.

Marker

Accesses a menu that enables you to select, set up and control the markers for the current measurement.

See “Marker” on page 1039 in the section "Common Measurement Functions" for more information

Key Path	Front-panel key
Initial S/W Revision	Prior to A.02.00

Select Marker

Displays 12 markers available for selection.

Key Path	Marker
Initial S/W Revision	Prior to A.02.00

Marker Type

Sets the marker control mode to **Normal**, **Delta**, **Fixed** or **Off**. All interactions and dependencies detailed under the key description are enforced when the remote command is sent. If the selected marker is Off, pressing Marker sets it to Normal and places it at the center of the screen on the trace determined by the **Marker Trace** rules. At the same time, the Marker X Axis Value appears on the Active Function area.

The default active function is the active function for the currently selected marker control mode. If the current control mode is Off, there is no active function and the active function is turned off.

Key Path	Marker
Mode	BASIC, PN, WCDMA, C2K, GSM, WIMAX OFDMA, TD-SCDMA, 1xEV-DO, DVB-T/H, DTMB (CTTB), ISDB-T, CMMB, LTE, LTETDD
Remote Command	:CALCulate:WAVEform:MARKer [1] 2 3 4 5 6 7 8 9 10 11 12 : MODE POSITION DELTA OFF :CALCulate:WAVEform:MARKer [1] 2 3 4 5 6 7 8 9 10 11 12 : MODE?
Example	CALC:WAV:MARK:MODE OFF CALC:WAV:MARK:MODE?

Notes	<p>If the selected marker is Off, pressing Marker sets it to Normal and places it at the center of the screen on the trace determined by the Marker Trace rules. At the same time, Marker X Axis Value appears on the Active Function area.</p> <p>Default Active Function: the active function for the selected marker's current control mode. If the current control mode is Off, there is no active function and the active function is turned off.</p> <p>Active Function Display: the marker X axis value entered in the active function area displays the marker value to its full entered precision.</p> <p>You must be in a mode that includes the Waveform measurement to use this command. Use INSTRument:SElect to set the mode.</p>
Preset	=OFF
Preset	OFF
State Saved	Saved in instrument state.
Range	Normal Delta Off
Initial S/W Revision	Prior to A.02.00
Modified at S/W Revision	A.03.00

Marker X Axis Value (Remote Command Only)

Sets the marker X Axis value in the current marker X Axis Scale unit. It has no effect if the control mode is **Off**, but is the SCPI equivalent of entering an X value if the control mode is **Normal** or **Delta**.

Mode	BASIC, PN, WCDMA, C2K, GSM, WIMAX OFDMA, TD-SCDMA, 1xEV-DO, DVB-T/H, DTMB (CTTB), ISDB-T, CMMB, LTE, LTETDD
Remote Command	<pre>:CALCulate:WAVEform:MARKer [1] 2 3 4 5 6 7 8 9 10 11 12 : X <time></pre> <pre>:CALCulate:WAVEform:MARKer [1] 2 3 4 5 6 7 8 9 10 11 12 : X?</pre>
Example	<pre>CALC:WAV:MARK:X 50 ms</pre> <pre>CALC:WAV:MARK:X?</pre>
Notes	<p>If no suffix is sent, uses the fundamental units for the current marker X Axis Scale. If a suffix is sent that does not match the current marker X Axis Scale unit, an error "Invalid suffix" is generated. If the specified marker is Fixed and a Marker Function is on, error -221 "Settings conflict; cannot adjust Fixed marker while Marker Function is on" is generated.</p> <p>The query returns the marker's absolute X Axis value if the control mode is Normal, or the offset from the marker's reference marker if the control mode is Delta. The query is returned in the fundamental units for the current marker X Axis scale: Hz for Frequency and Inverse Time, seconds for Period and Time. If the marker is Off the response is not a number.</p> <p>You must be in the mode that includes Waveform measurement to use this command. Use INSTRument:SElect to set the mode.</p>

Preset	0
Preset	After a preset, all markers are turned OFF, so Marker X Axis Value query returns a not a number (NAN).
State Saved	No
Min	-9.9E+37
Max	9.9E+37
Initial S/W Revision	Prior to A.02.00
Modified at S/W Revision	A.03.00

Marker X Axis Position (Remote Command Only)

Sets the marker X position in trace points. It has no effect if the control mode is **Off**, but is the SCPI equivalent of entering a value if the control mode is **Normal** or **Delta**. The entered value is immediately translated into the current X Axis Scale units for setting the value of the marker.

Mode	BASIC, PN, WCDMA, C2K, GSM, WIMAX OFDMA, TD-SCDMA, 1xEV-DO, DVB-T/H, DTMB (CTTB), ISDB-T, CMMB, LTE, LTETDD
Remote Command	:CALCulate:WAVEform:MARKer [1] 2 3 4 5 6 7 8 9 10 11 12 : X:POSition <real> :CALCulate:WAVEform:MARKer [1] 2 3 4 5 6 7 8 9 10 11 12 : X:POSition?
Example	CALC:WAV:MARK:X:POS 500 CALC:WAV:MARK:X:POS?
Notes	The query returns the marker's absolute X Axis value in trace points if the control mode is Normal or the offset from the marker's reference marker in trace points if the control mode is Delta . The value is returned as a real number, not an integer, corresponding to the translation from X Axis Scale units to trace points. You must be in the mode that includes Waveform measurement to use this command. Use INSTRument:SElect to set the mode.
Preset	0
Preset	After a preset, all markers are turned OFF, so Marker X Axis Value query returns a not a number (NAN).
State Saved	No
Min	-9.9E+37
Max	9.9E+37
Initial S/W Revision	Prior to A.02.00
Modified at S/W Revision	A.03.00

Marker Y Axis Value (Remote Command Only)

Queries the marker Y Axis value in the current marker Y Axis unit.

Mode	BASIC, PN, WCDMA, C2K, GSM, WIMAX OFDMA, TD-SCDMA, 1xEV-DO, DVB-T/H, DTMB (CTTB), ISDB-T, CMMB, LTE, LTETDD
Remote Command	:CALCulate:WAVeform:MARKer [1] 2 3 4 5 6 7 8 9 10 11 12 : Y?
Example	CALC:WAV:MARK11:Y?
Notes	<p>When the marker is on, IQ waveform returns I and Q values.</p> <p>Case #1 - Trace RF: returns a single double value.</p> <pre>>:CALC:WAV:MARK1:Y? -2.402406506109E+001</pre> <p>Case #2 - Trace IQ: returns a double array of two values, the first is X, and the second is Y.</p> <pre>>:CALC:WAV:MARK1:Y? -3.006944493834E-003,+9.9870666467354E-004</pre> <p>You must be in a mode that includes the Waveform measurement to use this command. Use INSTRument:SELEct to set the mode.</p>
Preset	Result dependant on the marker setup and signal source.
State Saved	No
Backwards Compatibility SCPI	:CALCulate:WAVeform:MARKer[1] 2 3 4 5 6 7 8 9 10 11 12:FUNCTion:RESuIt?
Initial S/W Revision	Prior to A.02.00
Modified at S/W Revision	A.03.00

Properties

Accesses the marker properties menu.

Key Path	Marker
Initial S/W Revision	Prior to A.02.00

Select Marker

Displays 12 markers available for selection.

Key Path	Marker
Initial S/W Revision	Prior to A.02.00

Relative To

Selects the marker that the selected marker is relative to (its reference marker).

Key Path	Marker, Properties
Mode	BASIC, PN, WCDMA, C2K, GSM, WIMAX OFDMA, TD-SCDMA, 1xEV-DO, DVB-T/H, DTMB (CTTB), ISDB-T, CMMB, LTE, LTETDD
Remote Command	:CALCulate:WAVEform:MARKer [1] 2 3 4 5 6 7 8 9 10 11 12 : REFerence <integer> :CALCulate:WAVEform:MARKer [1] 2 3 4 5 6 7 8 9 10 11 12 : REFerence?
Example	CALC:WAV:MARK:REF 8 CALC:WAV:MARK:REF?
Notes	A marker cannot be relative to itself so that choice is grayed out, and if sent from SCPI generates error -221: "Settings conflict; marker cannot be relative to itself." When queried a single value is returned (the specified marker numbers relative marker). You must be in a mode that includes the Waveform measurement to use this command. Use INSTRUMENT:SElect to set the mode.
Preset	2 3 4 5 6 7 8 9 10 11 12 1
State Saved	Saved in instrument state.
Min	1
Max	12
Initial S/W Revision	Prior to A.02.00
Modified at S/W Revision	A.03.00

Marker Trace

Assigns the specified marker to the designated trace.

Key Path	Marker
Mode	BASIC, PN, WCDMA, C2K, GSM, WIMAX OFDMA, TD-SCDMA, 1xEV-DO, DVB-T/H, DTMB (CTTB), ISDB-T, CMMB, LTE, LTETDD
Remote Command	:CALCulate:WAVEform:MARKer [1] 2 3 4 5 6 7 8 9 10 11 12 : TRACe RFENvelope IQ :CALCulate:WAVEform:MARKer [1] 2 3 4 5 6 7 8 9 10 11 12 : TRACe?
Example	CALC:WAV:MARK:TRAC RFEN CALC:WAV:MARK:TRAC?

Waveform Measurement
Marker

Notes	Assigns the specified marker to the designated trace. You must be in a mode that includes the Waveform measurement to use this command. Use INSTRument:SElect to set the mode.
Preset	RFEN
State Saved	Saved in instrument state.
Range	RF Envelope IQ Waveform
Initial S/W Revision	Prior to A.02.00
Modified at S/W Revision	A.03.00

Couple Markers

Toggles the state of the markers to be coupled On or Off. When this function is true (On), moving any marker causes an equal X-axis movement of every other marker which is not **Off**. “Equal X-axis movement” refers to the difference between each marker’s X-Axis value (in the fundamental x-axis units of the trace that marker is on) and the X-Axis value of the marker being moved (in the same fundamental x-axis units) are preserved.

Key Path	Marker
Mode	BASIC, PN, WCDMA, C2K, GSM, WIMAX OFDMA, TD-SCDMA, 1xEV-DO, DVB-T/H, DTMB (CTTB), ISDB-T, CMMB, LTE, LTETDD
Remote Command	:CALCulate:WAVEform:MARKer:COUple[:STATE] ON OFF 1 0 :CALCulate:WAVEform:MARKer:COUple[:STATE]?
Example	CALC:WAV:MARK:COUP ON CALC:WAV:MARK:COUP ON
Notes	You must be in a mode that includes the Waveform measurement to use this command. Use INSTRument:SElect to set the mode.
Preset	OFF
State Saved	Saved in instrument state.
Range	On Off
Initial S/W Revision	Prior to A.02.00
Modified at S/W Revision	A.03.00

All Markers Off

Turns off all markers.

Key Path	Marker
Mode	BASIC, PN, WCDMA, C2K, GSM, WIMAX OFDMA, TD-SCDMA, 1xEV-DO, DVB-T/H, DTMB (CTTB), ISDB-T, CMMB, LTE, LTETDD

Remote Command	:CALCulate:WAVEform:MARKer:AOff
Example	CALC:WAV:MARK:AOff
Notes	You must be in a mode that includes the Waveform measurement to use this command. Use INSTRument:SElect to set the mode.
Initial S/W Revision	Prior to A.02.00
Modified at S/W Revision	A.03.00

Backward Compatibility SCPI Commands

Sets or queries the state of a marker. Setting a marker which is OFF to state ON or 1 puts it in Normal mode and places it at the center of the screen.

Mode	BASIC, PN, WCDMA, C2K, GSM, WIMAX OFDMA, TD-SCDMA, 1xEV-DO, DVB-T/H, DTMB (CTTB), ISDB-T, CMMB, LTE, LTETDD
Remote Command	:CALCulate:WAVEform:MARKer [1] 2 3 4 5 6 7 8 9 10 11 12 : STATe OFF ON 0 1 :CALCulate:WAVEform:MARKer [1] 2 3 4 5 6 7 8 9 10 11 12 : STATe?
Example	CALC:WAV:MARK:STAT ON CALC:WAV:MARK:STAT?
Notes	You must be in a mode that includes the Waveform measurement to use this command. Use INSTRument:SElect to set the mode.
Preset	OFF
State Saved	Saved in instrument state.
Range	On Off
Initial S/W Revision	Prior to A.02.00
Modified at S/W Revision	A.03.00

Marker Function

Accesses a menu of marker functions that perform post-processing operations on markers based on the measurement specifications. Marker functions are distinct from Measurement functions, which automatically perform complex sequences of setup, data acquisition, and display operations in order to measure specified signal characteristics. Marker Functions are specified for each individual marker and may be turned on individually for each marker.

The **Marker Function** menu controls which marker functions are turned on and allows you to adjust the setup parameters for each function. These parameters include the following, but only one parameter can be assigned to a given marker:

- Marker Noise
- Band/Interval Power
- Band/Interval Density
- Marker Function Off

Key Path	Front-panel key
Initial S/W Revision	Prior to A.02.00

Select Marker

Displays 12 markers available for selection.

Key Path	Marker
Initial S/W Revision	Prior to A.02.00

Marker Function Type

Sets the marker control function type to, Marker Noise, Band/Interval Power, Band Interval Density, or Marker Function Off

Key Path	Marker Function
Mode	BASIC, PN, WCDMA, C2K, GSM, WIMAX OFDMA, TD-SCDMA, 1xEV-DO, DVB-T/H, DTMB (CTTB), ISDB-T, CMMB, LTE, LTETDD
Remote Command	:CALCulate:WAVeform:MARKer [1] 2 3 4 5 6 7 8 9 10 11 12 : FUNction BPOwer BDENsity OFF :CALCulate:WAVeform:MARKer [1] 2 3 4 5 6 7 8 9 10 11 12 : FUNction?
Example	CALC:WAV:MARK:FUNC BPOW CALC:WAV:MARK:FUNC?

Notes	You must be in a mode that includes the Waveform measurement to use this command. Use INSTRUMENT:SElect to set the mode.
Preset	=OFF
Preset	OFF
State Saved	Saved in instrument state.
Range	Band/Interval Power Band Interval Density Marker Function Off
Initial S/W Revision	Prior to A.02.00
Modified at S/W Revision	A.03.00

Band Adjust

Accesses a menu that enables you to set the frequency span width and the left and right edge, or time values, for the band or interval of the selected marker.

Key Path	Marker Function
Initial S/W Revision	Prior to A.02.00

Band/Interval Span for Time Domain

Sets the width of the frequency span for the selected marker.

Key Path	Marker Function
Mode	BASIC, PN, WCDMA, C2K, GSM, WIMAX OFDMA, TD-SCDMA, 1xEV-DO, DVB-T/H, DTMB (CTTB), ISDB-T, CMMB, LTE, LTETDD
Remote Command	:CALCulate:WAVEform:MARKer [1] 2 3 4 5 6 7 8 9 10 11 12 : FUNCTION:BAND:SPAN <time> :CALCulate:WAVEform:MARKer [1] 2 3 4 5 6 7 8 9 10 11 12 : FUNCTION:BAND:SPAN?
Example	CALC:WAV:MARK:FUNC:BAND:SPAN 20 ms CALC:WAV:MARK:FUNC:BAND:SPAN?
Notes	You must be in a mode that includes the Waveform measurement to use this command. Use INSTRUMENT:SElect to set the mode.
Couplings	Changing the Band/Interval Span necessarily changes the Band/Interval Left and Band/Interval Right values
Preset	0
Preset	10% of Meas Time
State Saved	Saved in instrument state.
Min	0
Max	100s

Waveform Measurement
Marker Function

Backwards Compatibility SCPI	:CALCulate:WAVeform:MARKer[1] 2 3 4:X:SPAN
Initial S/W Revision	Prior to A.02.00
Modified at S/W Revision	A.03.00

Band/Interval Left for Time Domain

Sets the left edge frequency or time value for the band of the selected marker.

Key Path	Marker Function
Mode	BASIC, PN, WCDMA, C2K, GSM, WIMAX OFDMA, TD-SCDMA, 1xEV-DO, DVB-T/H, DTMB (CTTB), ISDB-T, CMMB, LTE, LTETDD
Remote Command	:CALCulate:WAVeform:MARKer[1] 2 3 4 5 6 7 8 9 10 11 12:FUNction:BAND:LEFT <time> :CALCulate:WAVeform:MARKer[1] 2 3 4 5 6 7 8 9 10 11 12:FUNction:BAND:LEFT?
Example	CALC:WAV:MARK12:FUNC:BAND:LEFT 1 s CALC:WAV:MARK12:FUNC:BAND:LEFT?
Notes	You must be in a mode that includes the Waveform measurement to use this command. Use INSTRument:SElect to set the mode.
Couplings	Changing the Band/Interval Left necessarily changes the Band/Interval Span and Band/Interval Right values
Preset	0
Preset	5% of Meas Time
State Saved	Saved in instrument state.
Min	0
Max	100s
Initial S/W Revision	Prior to A.02.00
Modified at S/W Revision	A.03.00

Band/Interval Right for Time Domain

Sets the right edge frequency or time value for the band of the selected marker.

Key Path	Marker Function
Mode	BASIC, PN, WCDMA, C2K, GSM, WIMAX OFDMA, TD-SCDMA, 1xEV-DO, DVB-T/H, DTMB (CTTB), ISDB-T, CMMB, LTE, LTETDD

Remote Command	:CALCulate:WAVEform:MARKer[1] 2 3 4 5 6 7 8 9 10 11 12: FUNction:BAND:RIGHT <time> :CALCulate:WAVEform:MARKer[1] 2 3 4 5 6 7 8 9 10 11 12: FUNction:BAND:RIGHT?
Example	CALC:WAV:MARK12:FUNC:BAND:RIGH 1 s CALC:WAV:MARK12:FUNC:BAND:RIGH?
Notes	You must be in a mode that includes the Waveform measurement to use this command. Use INSTRument:SElect to set the mode.
Couplings	Changing the Band/Interval Left necessarily changes the Band/Interval Span and Band/Interval Right values
Preset	0
Preset	5% of Meas Time
State Saved	Saved in instrument state.
Min	0
Max	100s
Initial S/W Revision	Prior to A.02.00
Modified at S/W Revision	A.03.00

Marker To

There is no 'Marker To' functionality supported in Waveform measurements. The front-panel key displays a blank menu when pressed.

Key Path	Front-panel key
Initial S/W Revision	Prior to A.02.00

Meas

See [“Meas” on page 1083](#) in the section "Common Measurement Functions" for more information.

Meas Setup

Displays the setup menu keys that enable you to control the parameters for the current measurement.

Key Path	Front-panel key
Initial S/W Revision	Prior to A.02.00

Average/Hold Num

Sets the number of sweeps (average counts) that are averaged. After the specified number of sweeps, the averaging mode (terminal control) setting determines the averaging action.

Key Path	Meas Setup
Mode	BASIC, PN, WCDMA, C2K, GSM, WIMAX OFDMA, TD-SCDMA, 1xEV-DO, DVB-T/H, DTMB (CTTB), ISDB-T, CMMB, LTE, LTETDD
Remote Command	[:SENSe] :WAVeform:AVERage:COUNT <integer> [:SENSe] :WAVeform:AVERage:COUNT? [:SENSe] :WAVeform:AVERage[:STATe] OFF ON 0 1 [:SENSe] :WAVeform:AVERage[:STATe] ?
Example	WAV:AVER:COUN 1001 WAV:AVER:COUN? WAV:AVER ON WAV:AVER?
Notes	You must be in a mode that includes the Waveform measurement to use this command. Use INSTRument:SElect to set the mode.
Preset	10 OFF
State Saved	Saved in instrument state.
Min	1
Max	20001
Initial S/W Revision	Prior to A.02.00
Modified at S/W Revision	A.03.00

Avg Mode

Enables you to set the averaging mode.

When set to Exponential (Exp) the measurement averaging continues using the specified number of

averages to compute each averaged value. The average is displayed at the end of each sweep.

When set to Repeat, the measurement resets the average counter each time the specified number of averages is reached.

Key Path	Meas Setup
Mode	BASIC, PN, WCDMA, C2K, GSM, WIMAX OFDMA, TD-SCDMA, 1xEV-DO, DVB-T/H, DTMB (CTTB), ISDB-T, CMMB, LTE, LTETDD
Remote Command	[:SENSE] :WAVeform:AVERage:TCONtrol EXPonential REPEAT [:SENSE] :WAVeform:AVERage:TCONtrol?
Example	WAV:AVER:TCON REP WAV:AVER:TCON?
Notes	You must be in a mode that includes the Waveform measurement to use this command. Use INSTRument:SElect to set the mode.
Preset	EXPonential
State Saved	Saved in instrument state.
Range	Exp Repeat
Initial S/W Revision	Prior to A.02.00
Modified at S/W Revision	A.03.00

Avg Type

Selects the type of averaging.

Key Path	Meas Setup
Mode	BASIC, PN, WCDMA, C2K, GSM, WIMAX OFDMA, TD-SCDMA, 1xEV-DO, DVB-T/H, DTMB (CTTB), ISDB-T, CMMB, LTE, LTETDD
Remote Command	[:SENSE] :WAVeform:AVERage:TYPE LOG MAXimum MINimum RMS SCALar [:SENSE] :WAVeform:AVERage:TYPE?
Example	WAV:AVER:TYPE MAX WAV:AVER:TYPE?
Notes	The SCPI selection of MAX and MIN are kept for BWCC, but they are removed from the front panel access because they are not an Average function. You must be in a mode that includes the Waveform measurement to use this command. Use INSTRument:SElect to set the mode.
Preset	RMS
State Saved	Saved in instrument state.

Waveform Measurement
Meas Setup

Range	Pwr Avg(RMS) Log-Pwr Avg(Video) Voltage Avg
Initial S/W Revision	Prior to A.02.00
Modified at S/W Revision	A.03.00

HW Averaging

Changes the number of time averages is to be made using hardware. This averaging is much faster than the standard averaging done in software. The hardware averaging is done on the complex voltage time trace data before any measurement application averaging is done. Both types of averaging (HW and SW) can be done on the same measurement data.

When time averaging is being done in HW, each trace update represents N fresh data acquisitions averaged together, where N is the number of averages. You cannot access the individual time data. Note that in the spectrum measurement this averaging is done prior to the standard averaging done within the application. Thus the yellow trace in this measurement shows the result of the time averaging. Subsequent averaging is orthogonal to this hardware based time averaging and its result is seen as the blue trace in this and other applications.

So it is possible to turn off the averaging within the application but still have the HW averaging set to a certain number. In another words, turning averaging off within the measurement will not affect HW averaging. If HW averaging needs to be turned off, simply set the HW Averaging parameter to 1.

Since it is time averaging, a trigger source something other than FreeRun should be used to avoid cancelling out the signal to be measured. It is most useful for a periodic signal with known periods.

Time Avg Num

Sets the number of HW averages to be executed per each data acquisition.

Key Path	Meas Setup
Mode	BASIC
Remote Command	[:SENSe] :WAVeform:AVERAge:TACount <integer> [:SENSe] :WAVeform:AVERAge:TACount?
Example	WAV:AVER:TAC 10 WAV:AVER:TAC?
Notes	This feature is only available with Pxa or when Option B40 is installed.
Preset	1
State Saved	Saved in instrument state.
State Saved	Saved in state
Min	1
Max	65535
Default Unit	Enter

Sample Rate

The user is able to set an arbitrary sample rate for the acquired data to be processed.

Key Path	Meas Setup
Mode	BASIC
Remote Command	[:SENSe] :WAVeform:SRATe <freq> [:SENSe] :WAVeform:SRATe?
Example	WAV:SRAT 1.3636 MHz
Couplings	The coupling between Sample Rate and IF Bw depends on Physics implementation.
Preset	125.0 kHz
Min	12.5 Hz
Max	(For Pxa or Option B40) Digital IF 10 MHz path: 12.5 MHz Digiral IF 25 MHz path: 31.25 MHz Digital IF 40 MHz path: 50 MHz Option B1X 140 MHz path: 175 MHz (For all other configuration) 10 MHz path: 15 MHz Option B25 25MHz path: 45 MHz
ParameterType	FrequencyParameter
Restriction and Notes	Command and query available with Pxa or when Option B40 is installed. For other configuration, only query is available. With a Swept DIF + Option B40 or B1X configuration the parameter is query only when the IF Path Selection is either 10 MHz or 25 MHz and the command is enabled when it is 140 MHz.

Sample Period (Aperture) Setting (Remote Command Only)

Returns the time between samples (sample period or aperture).

This value is RUI only and query only and coupled to the sample rate.

Parameter Name):	SamplePeriod
Mode:	BASIC
Remote Command:	[:SENSe] :WAVeform:APERture?
Example:	WAV:APER?
Notes:	SCPI only. Query only.

Waveform Measurement
Meas Setup

Couplings:	Coupled to Sample Rate by the following equation. $\text{Sample Period} = 1/(\text{Sample Rate})$
Preset:	1/(Sample Rate Default)
Min:	1/(Max Sample Rate)
Max:	1/(Min Sample Rate)

Meas Time

Sets how long the measurement is performed. X Scale only changes the representation of the display.

Key Path	Meas Setup
Mode	BASIC, PN, WCDMA, C2K, GSM, WIMAX OFDMA, TD-SCDMA, 1xEV-DO, DVB-T/H, DTMB (CTTB), ISDB-T, CMMB, LTE, LTETDD
Remote Command	[:SENSE] :WAVeform:SWEep:TIME <time> [:SENSE] :WAVeform:SWEep:TIME?
Example	WAV:SWE:TIME 50 ms WAV:SWE:TIME?
Notes	Specifies and returns how long the measurement is performed. It is the time record length of the measurement waveform. The Max time may be reduced when the sample frequency is high due to the memory limitation. You must be in a mode that includes the Waveform measurement to use this command. Use INSTRument:SElect to set the mode.
Preset	2.000000 ms
State Saved	Saved in instrument state.
Range	1.000 (s to 100.00 s)
Initial S/W Revision	Prior to A.02.00
Modified at S/W Revision	A.03.00

Meas Preset

Restores all the measurement parameters to their default values.

Key Path	Meas Setup
Mode	BASIC, PN, WCDMA, C2K, GSM, WIMAX OFDMA, TD-SCDMA, 1xEV-DO, DVB-T/H, DTMB (CTTB), ISDB-T, CMMB, LTE, LTETDD
Remote Command	:CONFigure:WAVeform
Example	CONF:WAV

Notes	Restore default values of all parameters. You must be in a mode that includes the Waveform measurement to use this command. Use INSTRument:SElect to set the mode.
Initial S/W Revision	Prior to A.02.00
Modified at S/W Revision	A.03.00

Advanced

Accesses a menu of “advanced” functions that are used for specific applications. These settings should not be changed for most measurements.

Key Path	Meas Setup
Initial S/W Revision	Prior to A.02.00

ADC Dither

Accesses the ADC Dither control menu.

Key Path	Meas Setup, Advanced
Initial S/W Revision	Prior to A.02.00

ADC Dither Auto

Sets ADC dithering to automatically select whether dithering is needed.

Key Path	Meas Setup, Advanced, ADC Dither
Mode	BASIC, PN, WCDMA, C2K, GSM, WIMAX OFDMA, TD-SCDMA, 1xEV-DO, DVB-T/H, DTMB (CTTB), ISDB-T, CMMB, LTE, LTETDD
Remote Command	[:SENSE] :WAVEform:ADC:DITHer:AUTO [:STATe] OFF ON 0 1 [:SENSE] :WAVEform:ADC:DITHer:AUTO [:STATe] ?
Example	WAV:ADC:DITH:AUTO ON WAV:ADC:DITH:AUTO?
Notes	The dither function improves linearity for low level signals, at the expense of a higher noise floor. You must be in a mode that includes the Waveform measurement to use this command. Use INSTRument:SElect to set the mode.
Preset	OFF
State Saved	Saved in instrument state.
Range	On Off
Initial S/W Revision	Prior to A.02.00

Modified at S/W Revision	A.03.00
--------------------------	---------

ADC Dither

Toggles the dither function On and Off. The dither function improves linearity for low level signals, at the expense of a higher noise floor.

The reduced clipping-to-noise ratio results in higher noise, because the clipping level of the ADC relative to the front terminals remains unchanged with the introduction of dither. The enhanced linearity is mostly improved scale fidelity.

With dither on, the third-order distortions are usually invisible for mixer levels below -35 dBm. With dither off, these distortions can be visible, with typical power levels of -110 dBm referred to the mixer. Detection nonlinearity can reach 1 dB for dither off at mixer levels around -70 dBm and lower, while the specified nonlinearity is many times smaller with dither on.

Key Path	Meas Setup, Advanced, ADC Dither
Mode	BASIC, PN, WCDMA, C2K, GSM, WIMAX OFDMA, TD-SCDMA, 1xEV-DO, DVB-T/H, DTMB (CTTB), ISDB-T, CMMB, LTE, LTETDD
Remote Command	[:SENSe] :WAVeform:ADC:DITHer [:STATE] OFF ON 0 1 [:SENSe] :WAVeform:ADC:DITHer [:STATE] ?
Example	WAV:ADC:DITH ON WAV:ADC:DITH?
Notes	The dither function improves linearity for low level signals, at the expense of a higher noise floor. . You must be in a mode that includes the Waveform measurement to use this command. Use INSTRument:SELEct to set the mode.
Preset	OFF
State Saved	Saved in instrument state.
Range	Auto Man
Backwards Compatibility SCPI	[:SENSe] :WAVeform:WBIF:ADC:DITHer [:SENSe] :WAVeform:PDITHer
Initial S/W Revision	Prior to A.02.00
Modified at S/W Revision	A.03.00

IF Gain

Sets the IF Gain function to Auto, Low Gain or High Gain. These settings affect sensitivity and IF overloads.

This only applies to the RF input. It does not apply to baseband I/Q input.

Key Path	Meas Setup, Advanced
----------	----------------------

Initial S/W Revision	Prior to A.02.00
----------------------	------------------

IF Gain Auto

Activates the auto rules for IF Gain

Key Path	Meas Setup, Advanced, IF Gain
Mode	BASIC, PN, WCDMA, C2K, GSM, WIMAX OFDMA, TD-SCDMA, 1xEV-DO, DVB-T/H, DTMB (CTTB), ISDB-T, CMMB, LTE, LTETDD
Remote Command	[:SENSE] :WAVEform:IF:GAIN:AUTO [:STATE] ON OFF 1 0 [:SENSE] :WAVEform:IF:GAIN:AUTO [:STATE] ?
Example	WAV:IF:GAIN:AUTO ON WAV:IF:GAIN:AUTO?
Notes	This only applies to the RF input. It does not apply to baseband I/Q input. You must be in a mode that includes the Waveform measurement to use this command. Use INSTRument:SElect to set the mode.
Preset	ON
State Saved	Saved in instrument state.
Range	On Off
Initial S/W Revision	Prior to A.02.00
Modified at S/W Revision	A.03.00

IF Gain State

Selects the range of IF gain.

Key Path	Meas Setup, Advanced, IF Gain
Mode	BASIC, PN, WCDMA, C2K, GSM, WIMAX OFDMA, TD-SCDMA, 1xEV-DO, DVB-T/H, DTMB (CTTB), ISDB-T, CMMB, LTE, LTETDD
Remote Command	[:SENSe] :WAVEform:IF:GAIN [:STATE] AUTOrange LOW HIGH [:SENSe] :WAVEform:IF:GAIN [:STATE] ?
Example	WAV:IF:GAIN HIGH WAV:IF:GAIN?
Notes	This only applies to the RF input and does not apply to baseband I/Q input. You must be in a mode that includes the Waveform measurement to use this command. Use INSTRument:SElect to set the mode.
Preset	AUTO
State Saved	Saved in instrument state.

Range	Autorange (Slower Follows Signals) Low (Best for Large Signals) High (Best Noise Level)
Readback Text	Autorange Low High
Initial S/W Revision	Prior to A.02.00
Modified at S/W Revision	A.03.00

IF Gain Offset

Sets the IF Gain offset for the 40MHz, 140MHz IF Paths in 2 dB step from -6 dB to +6 dB. Increasing the gain can increase the amplitude of small signals as long as you don't overdrive the hardware. Wideband gain should usually be adjusted after setting the input attenuation.

The IF Gain key is enabled for all IF Path selection but the IF Gain Offset is not activated when IF Path Selection is Narrow and IF Path Selection Narrow is either 10MHz or 25MHz.

Internally, the IF Gain value will change based on the current configuration of the HW. If the user chooses to offset this value, they may do so with this parameter. Hence the value specified is not an absolute value but relative to the current internal IF Gain setting.

For example:

IF Gain Low + IF Gain Offset +4dB = Total IF Gain of +4dB ($0 + 4 = 4$)

IF Gain High + IF Gain Offset +4 dB = Total IF Gain of +14dB ($10 + 4 = 14$)

IF Gain Low + IF Gain Offset -6dB = Total IF Gain of -6dB ($0 - 6 = -6$)

IF Gain High + IF Gain Offset -6dB = Total IF Gain of +6dB ($10 - 6 = 4$)

Thus the total IF Gain range when IF Gain Offset is available is a minimum of $0 - 6 = -6$ dB and a maximum of $10 + 6 = 16$ dB. The available IF Gain depends on the IF Path and center frequency. The maximum IF Gain may not be achievable at all times depending on the configuration.

Key Path	Meas Setup, Advanced, More 1of2
Remote Command	[:SENSE] :WAVEform:IF:GAIN:OFFSet <rel_amp1 > [:SENSE] :WAVEform:IF:GAIN:OFFSet?
Example	WAV:IF:GAIN:OFFS 2 Sets the IF Gain offset to 2
Couplings	If the IF Path Selection is B10M or B25M, then this feature is not available and is grayed out.
Preset	0
State Saved	Saved in instrument state
Min	-6
Max	+6
Default Unit	dB

Mode

See [“Mode” on page 1123](#) in the section "Common Measurement Functions" for more information.

Mode Setup

See “[Mode Setup](#)” on page 1141 in the section "Common Measurement Functions" for more information.

Peak Search

Places the selected marker on the trace point with the maximum y-axis value for that marker's trace and accesses a menu that enables you to select to do a minimum peak search.

Key Path	Front-panel key
Mode	BASIC, PN, WCDMA, C2K, GSM, WIMAX OFDMA, TD-SCDMA, 1xEV-DO, DVB-T/H, DTMB (CTTB), ISDB-T, CMMB, LTE, LTETDD
Remote Command	:CALCulate:WAVEform:MARKer [1] 2 3 4 5 6 7 8 9 10 11 12 : MAXimum
Example	CALC:WAV:MARK2:MAX
Notes	You must be in a mode that includes the Waveform measurement to use this command. Use INSTRument:SElect to set the mode.
Initial S/W Revision	Prior to A.02.00
Modified at S/W Revision	A.03.00

Next Peak

Moves the selected marker to the next highest local maximum with a value less than the current marker's.

Key Path	Peak Search
Mode	BASIC, PN, WCDMA, C2K, GSM, WIMAX OFDMA, TD-SCDMA, 1xEV-DO, DVB-T/H, DTMB (CTTB), ISDB-T, CMMB, LTE, LTETDD
Remote Command	:CALCulate:WAVEform:MARKer [1] 2 3 4 5 6 7 8 9 10 11 12 : MAXimum:NEXT
Example	CALC:WAV:MARK:MAX:NEXT
Notes	You must be in a mode that includes the Waveform measurement to use this command. Use INSTRument:SElect to set the mode.
Initial S/W Revision	Prior to A.02.00
Modified at S/W Revision	A.03.00

Min Search

Moves the selected marker to the minimum y-axis value on the current trace.

Key Path	Peak Search
Mode	BASIC, PN, WCDMA, C2K, GSM, WIMAX OFDMA, TD-SCDMA, 1xEV-DO, DVB-T/H, DTMB (CTTB), ISDB-T, CMMB, LTE, LTETDD

Waveform Measurement
Peak Search

Remote Command	:CALCulate:WAVeform:MARKer [1] 2 3 4 5 6 7 8 9 10 11 12 : MINimum
Example	CALC:WAV:MARK:MIN
Notes	You must be in a mode that includes the Waveform measurement to use this command. Use INSTRument:SElect to set the mode.
Initial S/W Revision	Prior to A.02.00
Modified at S/W Revision	A.03.00

Recall

See [“Recall” on page 153](#) in the section "Common Measurement Functions" for more information.

Restart

See “[Restart](#)” on page 1163 in the section "Common Measurement Functions" for more information.

Save

See [“Save” on page 170](#) in the section "Common Measurement Functions" for more information.

Single

See “[Single \(Single Measurement/Sweep\)](#)” on page 1169 in the section "Common Measurement Functions" for more information.

Source

See [“Source” on page 1171](#) in the section "Common Measurement Functions" for more information.

SPAN X Scale

Accesses a menu of functions that enable you to set the horizontal scale parameters.

Key Path	Front-panel key
Initial S/W Revision	Prior to A.02.00

Ref Value

Sets the reference value for time on the horizontal axis. When Auto Scaling is set to On, the displayed plots use a Scale/Div value determined by the analyzer, based on the measurement result.

Key Path	SPAN X Scale
Mode	BASIC, PN, WCDMA, C2K, GSM, WIMAX OFDMA, TD-SCDMA, 1xEV-DO, DVB-T/H, DTMB (CTTB), ISDB-T, CMMB, LTE, LTETDD
Remote Command	:DISPlay:WAVEform:VIEW[1] 2:WINDow[1]:TRACe:X[:SCALE]:RLEVEL <time> :DISPlay:WAVEform:VIEW[1] 2:WINDow[1]:TRACe:X[:SCALE]:RLEVEL?
Example	DISP:WAV:VIEW:WIND:TRAC:X:RLEV 10 ms DISP:WAV:VIEW:WIND:TRAC:X:RLEV?
Notes	You must be in a mode that includes the Waveform measurement to use this command. Use INSTRument:SElect to set the mode.
Couplings	If the Auto Scaling is set to On, this value is automatically determined by the measurement result. When you set this value manually, Auto Scaling automatically changes to Off.
Preset	0.00 s
State Saved	Saved in instrument state.
Min	-1.000 s
Max	10.00 s
Initial S/W Revision	Prior to A.02.00
Modified at S/W Revision	A.03.00

Scale/Div

Sets the horizontal scale by changing a time value per division.

Key Path	SPAN X Scale
----------	---------------------

Mode	BASIC, PN, WCDMA, C2K, GSM, WIMAX OFDMA, TD-SCDMA, 1xEV-DO, DVB-T/H, DTMB (CTTB), ISDB-T, CMMB, LTE, LTETDD
Remote Command	:DISPlay:WAVEform:VIEW[1] 2:WINDow[1]:TRACe:X[:SCALe]:PDIVision <time> :DISPlay:WAVEform:VIEW[1] 2:WINDow[1]:TRACe:X[:SCALe]:PDIVision?
Example	DISP:WAV:VIEW:WIND:TRAC:X:PDIV 500 us DISP:WAV:VIEW:WIND:TRAC:X:PDIV?
Notes	You must be in a mode that includes the Waveform measurement to use this command. Use INSTRument:SElect to set the mode.
Couplings	If the Auto Scaling is set to On, this value is automatically determined by the measurement result. When you set this value manually, Auto Scaling automatically changes to Off.
Preset	200.0 us
State Saved	Saved in instrument state.
Min	1.000 ns
Max	1.000 s
Initial S/W Revision	Prior to A.02.00
Modified at S/W Revision	A.03.00

Ref Position

Sets the reference position for the X axis to Left, Center or Right.

Key Path	SPAN X Scale
Mode	BASIC, PN, WCDMA, C2K, GSM, WIMAX OFDMA, TD-SCDMA, 1xEV-DO, DVB-T/H, DTMB (CTTB), ISDB-T, CMMB, LTE, LTETDD
Remote Command	:DISPlay:WAVEform:VIEW[1] 2:WINDow[1]:TRACe:X[:SCALe]:RPOSITION LEFT CENTer RIGHT :DISPlay:WAVEform:VIEW[1] 2:WINDow[1]:TRACe:X[:SCALe]:RPOSITION?
Example	DISP:WAV:VIEW:WIND:TRAC:X:RPOS LEFT DISP:WAV:VIEW:WIND:TRAC:X:RPOS?
Notes	Allows you to set the reference position to Left, Ctr (center) or Right. You must be in a mode that includes the Waveform measurement to use this command. Use INSTRument:SElect to set the mode.
Preset	LEFT
State Saved	Saved in instrument state.

Waveform Measurement
SPAN X Scale

Range	Left Ctr Right
Initial S/W Revision	Prior to A.02.00
Modified at S/W Revision	A.03.00

Auto Scaling

Toggles the scale coupling function between On and Off.

Key Path	SPAN X Scale
Mode	BASIC, PN, WCDMA, C2K, GSM, WIMAX OFDMA, TD-SCDMA, 1xEV-DO, DVB-T/H, DTMB (CTTB), ISDB-T, CMMB, LTE, LTETDD
Remote Command	:DISPlay:WAVeform:VIEW[1] 2 :WINDow[1] :TRACe:X[:SCALe]:COUPle 0 1 OFF ON :DISPlay:WAVeform:VIEW[1] 2 :WINDow[1] :TRACe:X[:SCALe]:COUPle?
Example	DISP:WAV:VIEW:WIND:TRAC:X:COUP ON DISP:WAV:VIEW:WIND:TRAC:X:COUP?
Notes	You must be in a mode that includes the Waveform measurement to use this command. Use INSTRument:SELEct to set the mode.
Couplings	When Auto Scaling is On and the Restart front-panel key is pressed, this function automatically determines the scale per division and reference values based on the measurement results. When you set a value to either Scale/Div or Ref Value manually, Auto Scaling automatically changes to Off.
Preset	1
State Saved	Saved in instrument state.
Range	On Off
Initial S/W Revision	Prior to A.02.00
Modified at S/W Revision	A.03.00

Sweep/Control

Accesses the Sweep menu that allows you to pause and restart the measurement.

See [“Sweep/Control” on page 1181](#) in the section "Common Measurement Functions" for more information.

Key Path	Front-panel key
Initial S/W Revision	Prior to A.02.00

Pause and Resume

Pauses a measurement after the current data acquisition is complete. When Paused, the label on the key changes to Resume. Pressing the Resume key resumes the measurement at the point it was at when paused.

See [“Pause/Resume” on page 1193](#) in the section "Common Measurement Functions" for more information.

Key Path	Sweep/Control
Initial S/W Revision	Prior to A.02.00

Trace/Detector

There is no 'Trace/Detector' functionality supported in the Waveform measurement. The front-panel key displays a blank menu when pressed.

Key Path	Front-panel key
Initial S/W Revision	Prior to A.02.00

Trigger

Accesses a menu of functions that enable you to select and control the trigger source for the current measurement

See [“Trigger” on page 1251](#) in the section "Common Measurement Functions" for information about all keys in this menu.

Key Path	Front-panel key
Initial S/W Revision	Prior to A.02.00

View/Display

Accesses a menu of functions that enable you to set up and control the display parameters for the current measurement.

This topic contains the following sections:

[“View Selection by name \(Remote Command Only\)” on page 902](#)

[“View Selection by number \(Remote Command Only\)” on page 902](#)

View Selection by name (Remote Command Only)

Selects the results view.

Key Path	View/Display
Mode	BASIC, PN, WCDMA, C2K, GSM, WIMAX OFDMA, TD-SCDMA, 1xEV-DO, DVB-T/H, DTMB (CTTB), ISDB-T, CMMB, LTE, LTETDD
Remote Command	:DISPlay:WAVeform:VIEW[:SElect] RFENvelope IQ :DISPlay:WAVeform:VIEW[:SElect]?
Example	DISP:WAV:VIEW RFEN DISP:WAV:VIEW?
Notes	You must be in a mode that includes the Waveform measurement to use this command. Use INSTRument:SElect to set the mode.
Preset	RFENveloper
State Saved	Saved in instrument state.
Range	RF Envelope IQ Waveform
Initial S/W Revision	Prior to A.02.00
Modified at S/W Revision	A.03.00

View Selection by number (Remote Command Only)

Displays the numeric values of the measurement results.

Mode	BASIC, PN, WCDMA, C2K, GSM, WIMAX OFDMA, TD-SCDMA, 1xEV-DO, DVB-T/H, DTMB (CTTB), ISDB-T, CMMB, LTE, LTETDD
Remote Command	:DISPlay:WAVeform:VIEW:NSElect <integer> :DISPlay:WAVeform:VIEW:NSElect?
Example	DISP:WAV:VIEW:NSEL 1 DISP:WAV:VIEW:NSEL?

Notes	You must be in a mode that includes the Waveform measurement to use this command. Use INSTRument:SElect to set the mode.
Preset	1
State Saved	Saved in instrument state.
Min	1
Max	2
Initial S/W Revision	Prior to A.02.00
Modified at S/W Revision	A.03.00

Key Path	Front-panel key
Initial S/W Revision	Prior to A.02.00

Display

Accesses a menu of functions that enable you to set the display parameters.

See [“Display” on page 1313](#) in the section "Common Measurement Functions" for more information.

Key Path	View/Display
Initial S/W Revision	Prior to A.02.00

RF Envelope

This view shows an example of the RF Envelope result for the waveform (time domain) measurements in the graph window. The measured values for the mean power and peak-to-mean power are shown in the text window.

Waveform Measurement
View/Display

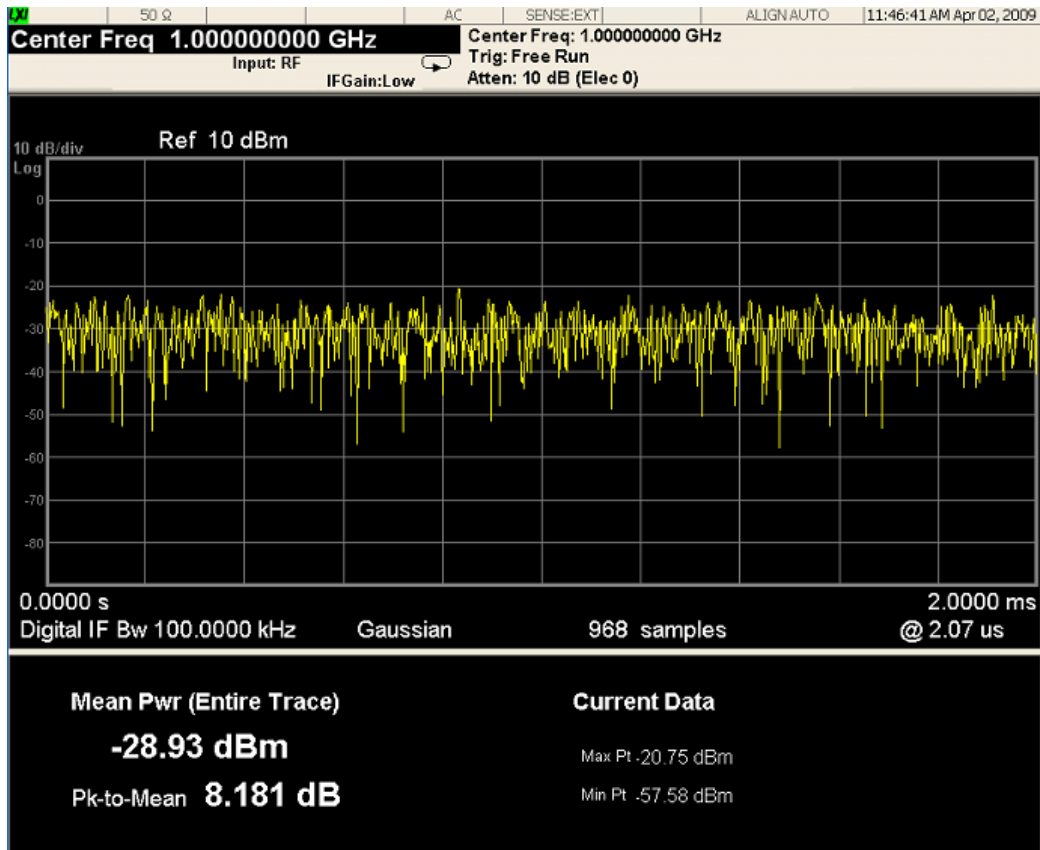

Numeric Results

Name	Type	Description	Unit	Format
Mean Pwr	Float64	The mean power (dBm). This is either the power across the entire trace, or the power between markers if the markers are enabled.	dBm	XX.XX dBm
Pk-to-Mean	Float64	This is the ratio of the maximum signal level to the mean power.	dB	XX.XX dB
Max Pt	Float64	The maximum of the most recently acquired data.	dBm	XX.XX dBm
Min Pt	Float64	The minimum of the most recently acquired data.	dBm	XX.XX dBm

Key Path	View/Display
Initial S/W Revision	Prior to A.02.00

I/Q Waveform

This view shows the I and Q signal waveforms in parameters of voltage versus time.

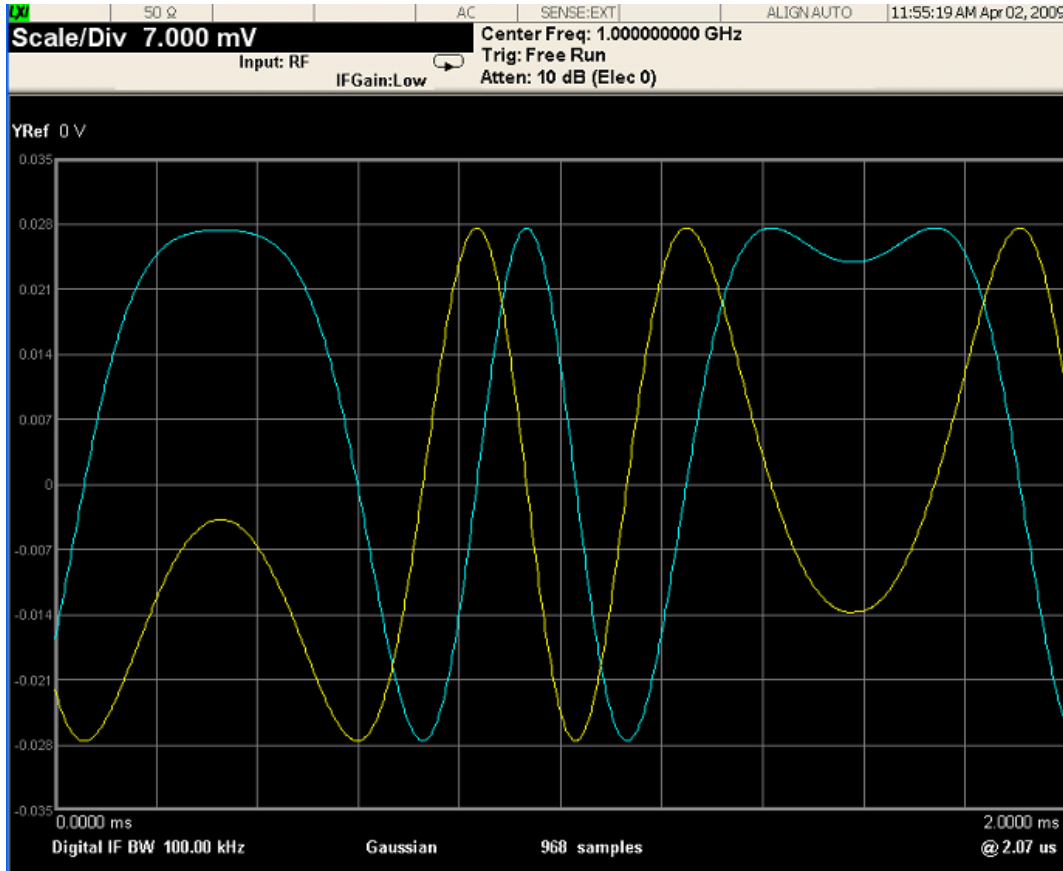

Key Path	View/Display
Initial S/W Revision	Prior to A.02.00

The key and command descriptions in this section describe functions that operate the same in multiple measurements and/or modes. This section is a library of functions that is referenced by many measurements and modes

To find the exact description and parameters for functions in a specific measurement, always look in the measurement section of this documentation. Pressing the front-panel key or softkey and then pressing the green Help key also provides the correct information.

NOTE

If you want to print the documentation, be sure to select this section and the measurement of interest to ensure having all the information you need. See [“Printing Acrobat Files” on page 103](#) for further instructions about printing.

AMPTD Y Scale

The Amplitude front-panel key activates the Amplitude menu and selects Reference Level or Reference Value (depending on the measurement) as the active function.

Some features in the Amplitude menu apply to multiple measurements; others apply only to specific measurements. Keys that only apply to some measurements are blanked or grayed out in measurements in which they are not supported

Key Path	Front-panel key
Initial S/W Revision	Prior to A.02.00

Reference Level

The Reference Level specifies the amplitude represented by the topmost graticule line.

Changing the reference level does not restart a measurement, because it is a display function only; instead it vertically ‘pans’ all displayed traces and markers to the new value. If a change to the reference level changes the attenuation value (e.g. through an auto coupling), then the measurement will be restarted.

See [“Amplitude Representations” on page 910](#)

Key Path	AMPTD Y Scale
Remote Command	:DISPlay:WINDow[1]:TRACe:Y[:SCALe]:RLEVel <real> :DISPlay:WINDow[1]:TRACe:Y[:SCALe]:RLEVel?
Example	DISP:WIND:TRAC:Y:RLEV 20 dBm Sets the reference level to 20 dBm, which displays in the current Y axis unit. For example, if the Y axis unit is dBμV, then 126.99 dBμV will be displayed.
Couplings	If you reduce the attenuation, the analyzer may have to lower the reference level to keep it below its allowed maximum. This allowed maximum level is specified in the “Max” row, below, along with other variables which affect it. When you increase attenuation, the reference level does not change.
Preset	0 dBm
State Saved	Saved in instrument state
Min	RefLevelMin = -170 dBm + RefLevelOffset - ExtGain.

AMPTD Y Scale

Max	<p>The maximum Ref Level is typically:</p> <p>+30 dBm + RL Offset – External Gain (for MXA and PXA)</p> <p>+23 dBm + RL Offset – External Gain (for EXA and CXA)</p> <p>This maximum value is determined by the maximum power that can be safely applied to the input circuitry. The actual maximum value at any given time may be even less than this, depending on other values including Mech Atten, Int Preamp Gain, Swept IF Gain, FFT IF Gain, Max Mixer Level, and the total attenuation currently available.</p>
Initial S/W Revision	Prior to A.02.00
Default Unit	Depends on the current selected Y axis unit

Amplitude Representations

The following is an illustration of the reference level and Y Axis scales under various conditions:

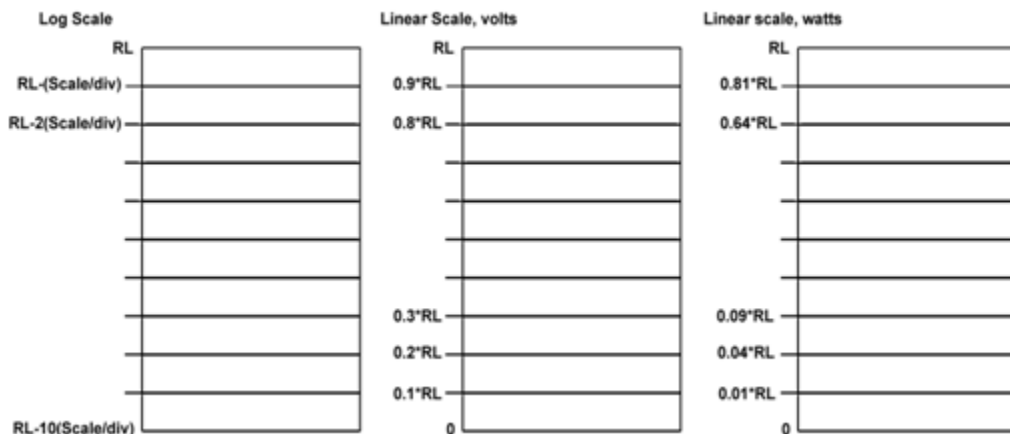

Attenuation

This menu controls the attenuator functions and interactions between the attenuation system components.

There are two attenuator configurations in the X-Series. One is a dual attenuator configuration consisting of a mechanical attenuator and an optional electronic attenuator. The other configuration uses a single attenuator with combined mechanical and electronic sections that controls all the attenuation functions. Different models in the X-Series come with different configurations.

See [“Dual Attenuator Configuration:”](#) on page 911.

See [“Single Attenuator Configuration:”](#) on page 911

Dual Attenuator Configuration:

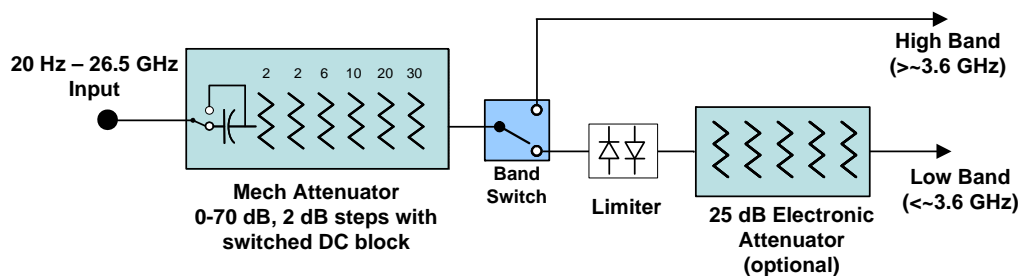

Single Attenuator Configuration:

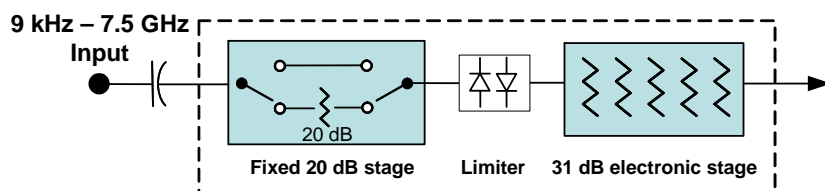

You can tell which attenuator configuration you have by pressing the Attenuation key, which (in most Modes) opens up the Attenuation menu. If the first key in the Attenuation menu says **Mech Atten** you have the dual attenuator configuration. If the first key says **Atten** you have the single attenuator configuration.

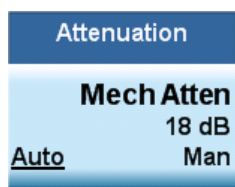

Dual Attenuator



Single Attenuator

In the single attenuator configuration, you control the attenuation with a single control, as the fixed stage has only two states. In the dual attenuator configuration, both stages have significant range so you are given separate control of the mechanical and electronic attenuator stages.

When you have the dual attenuator configuration, you may still have only a single attenuator, because unless you purchase the Electronic Attenuator option you will only have the mechanical attenuator.

Most Attenuation settings are the same for all measurements – they do not change as you change measurements.

Key Path	AMPTD Y Scale
Scope	Meas Global
Dependencies	In measurements which support the I/Q inputs, this key is unavailable when I/Q is the selected input, and is replaced by the Range key in that case.

AMPTD Y Scale

Readback Line	Contains a summary in [] brackets of the current total attenuation. See the descriptions of the “(Mech) Atten ” on page 912, “Enable Elec Atten” on page 914, and “Elec Atten” on page 916 keys for more detail on the contributors to the total attenuation. Note that when "Pre-Adjust for Min Clip" is on, this value can change at the start of every measurement.
Initial S/W Revision	Prior to A.02.00
Modified at S/W Revision	A.03.00

(Mech) Atten

This key is labeled **Mech Atten** in dual attenuator models and **Atten** in single attenuator models. In the dual attenuator configuration, this key only affects the mechanical attenuator.

This key lets you modify the attenuation applied to the RF input signal path. This value is normally auto coupled to the Ref Level, the Internal Preamp Gain, any External Gain that is entered, and the Max Mixer Level, as described in the table below.

See “Attenuator Configurations and Auto/Man” on page 913

Key Path	AMPTD Y Scale, Attenuation
Remote Command	[:SENSe]:POWER[:RF]:ATTenuation <rel_ampl> [:SENSe]:POWER[:RF]:ATTenuation? [:SENSe]:POWER[:RF]:ATTenuation:AUTO OFF ON 0 1 [:SENSe]:POWER[:RF]:ATTenuation:AUTO?
Example	POW:ATT 20 Dual attenuator configuration: sets the mechanical attenuator to 20 dB Single attenuator mode: sets the main attenuation to 20 dB (see below for definition of “main” attenuation). If the attenuator was in Auto, it sets it to Manual.
Dependencies	Some measurements do not support the Auto setting of (Mech) Atten . In these measurements, the Auto/Man selection is not available, and the Auto/Man line on the key disappears. In dual attenuator configurations, when the electronic attenuator is enabled, the mechanical attenuator has no auto setting and the Auto/Man line on the key disappears. The state of Auto/Man is remembered and restored when the electronic attenuator is once again disabled. This is described in more detail in the “Enable Elec Atten” on page 914 key description. See “Attenuator Configurations and Auto/Man” on page 913 for more information on the Auto/Man functionality of Attenuation.

Couplings	<p>When (Mech) Atten is in Auto, it uses the following algorithm to determine a value:</p> $\text{Atten} = \text{ReferenceLevel} + \text{PreAmpGain} + \text{ExternalGain} - \text{RefLevelOffset} - \text{MaxMixerLevel} + \text{IF Gain.}$ <p>Limit this value to be between 6 dB and the Max value. No value below 6 dB can ever be chosen by Auto.</p> <p>The resulting value is rounded up to the largest value possible given the attenuation step setting. That is, 50.01 dB would change to 60 dB (for a 10 dB attenuation step).</p> <p>The “IF Gain” term in the equation above is either 0 dB or +10 dB, depending on the settings of FFT IF Gain, Swept IF Gain, max Ref Level and the Auto/Man setting of Mech Atten.</p>
Preset	Auto
State Saved	Saved in instrument state
Min	<p>0 dB</p> <p>The attenuation set by this key cannot be decreased below 6 dB with the knob or step keys. To get to a value below 6 dB it has to be directly entered from the keypad or via SCPI. This protects from adjusting the attenuation to a dangerously small value which can put the instrument at risk of damage to input circuitry. However, if the current mechanical attenuation is below 6 dB it can be increased with the knob and step keys, but not decreased.</p>
Max	<p>CXA: 50 dB</p> <p>EXA: 60 dB</p> <p>MXA and PXA: 70 dB</p> <p>In the single attenuator configuration, the total of ATT and EATT cannot exceed 50 dB, so if the EATT is set to 24 dB first, the main attenuation cannot be greater than 26 dB and will be reduced accordingly; if the main attenuator is set to 40 dB first, EATT cannot be greater than 10 dB.</p>
Initial S/W Revision	Prior to A.02.00
Modified at S/W Revision	A.03.00

Attenuator Configurations and Auto/Man

As described in the Attenuation key description, there are two distinct attenuator configurations available in the X-Series, the single attenuator and dual attenuator configurations. In dual attenuator configurations, we have the mechanical attenuation and the electronic attenuation, and the current total attenuation is the sum of the electronic + mechanical attenuation. In single attenuator configurations, we refer to the attenuation set using the **(Mech) Atten** key (or POW:ATT SCPI) as the “main” attenuation; and the attenuation that is set by the SCPI command POW:EATT as the “soft” attenuation (the POW:EATT command is honored even in the single attenuator configuration, for compatibility purposes). Then the current total attenuation is the sum of the main + soft attenuation. See the **Elec Atten** key description for more on “soft” attenuation.

In the dual attenuator configuration, when the electronic attenuator is enabled, there is no Auto/Man

AMPTD Y Scale

functionality for the mechanical attenuator, and the third line of the key label (the Auto/Man line) disappears:

Mech Atten	
	0 dB
<u>Auto</u>	Man

Mech Atten	
	0 dB

Mech Atten when elec atten disabled
--

Mech Atten when elec atten enabled

vsd05

Enable Elec Atten

Enables the Electronic Attenuator in dual attenuator configurations. This key does not appear in single attenuator configurations, as in the single attenuator configuration there is no “electronic attenuator” there is only a single integrated attenuator (which has both a mechanical and electronic stage).

The electronic attenuator offers finer steps than the mechanical attenuator, has no acoustical noise, is faster, and is less subject to wear. These advantages primarily aid in remote operation and are negligible for front panel use. See [“Using the Electronic Attenuator: Pros and Cons” on page 916](#) for a detailed discussion of the pros and cons of using the electronic attenuator.

For the single attenuator configuration, for SCPI backwards compatibility, the “soft” attenuation feature replaces the dual attenuator configuration’s electronic attenuator. All the same couplings and limitations apply. See [“Attenuator Configurations and Auto/Man” on page 913](#)

See [“More Information” on page 915](#)

Key Path	AMPTD Y Scale, Attenuation
Remote Command	[:SENSe] :POWer [:RF] :EATTenuation:STATe OFF ON 0 1 [:SENSe] :POWer [:RF] :EATTenuation:STATe?
Example	POW:EATT:STAT ON
Dependencies	<p>This key only appears in the dual attenuator configuration. However, in the single attenuator configuration, EATT SCPI commands are accepted for compatibility with other X-series instruments and set a “soft” attenuation as described in “Attenuator Configurations and Auto/Man” on page 913</p> <p>The electronic attenuator (and the “soft” attenuation function provided in single attenuator configurations) is unavailable above 3.6 GHz. Therefore, if the Stop Frequency of the analyzer is > 3.6 GHz then the Enable Elec Atten key will be OFF and grayed out.</p> <p>If the Internal Preamp is on, meaning it is set to Low Band or Full, the electronic attenuator (and the “soft” attenuation function provided in single attenuator configurations) is unavailable. In this case the Enable Elec Atten key will be OFF and grayed out.</p> <p>If either of the above is true, if the SCPI command is sent, an error indicating that the electronic attenuator is unavailable will be sent.</p> <p>If the electronic/soft Attenuator is enabled, then the Stop Freq of the analyzer is limited to 3.6 GHz and the Internal Preamp is unavailable.</p>

Couplings	Enabling and disabling the Electronic Attenuator affects the setting of the Mechanical Attenuator (in dual attenuator configurations). This is described in more detail below this table.
Preset	OFF for Swept SA measurement; ON for all other measurements that support the electronic attenuator
State Saved	Saved in instrument state
Initial S/W Revision	Prior to A.02.00
Modified at S/W Revision	A.03.00

More Information

When the Electronic Attenuator is enabled, the Mechanical Attenuator transitions to a state in which it has no Auto function. Here are the rules for transitioning the Mechanical Attenuator:

When the Electronic Attenuation is enabled:

- In the dual attenuator configuration, the Mechanical Attenuator is initialized to 10 dB (this is its optimal performance setting). You can then set it as desired with SCPI, numeric keypad, step keys, or knob, and it behaves as it normally would in manual mode
- The Auto/Man state of (Mech) Atten is saved
- The Auto/Man line on the (Mech) Atten key disappears and the auto rules are disabled
- In the dual attenuator configuration, the Electronic Attenuator is set to 10 dB less than the previous value of the Mechanical Attenuator, within the limitation that it must stay within the range of 0 to 24 dB of attenuation.

Examples in the dual attenuator configuration:

- Mech Atten at 20 dB. Elec Atten enabled, Mech Atten set to 10 dB, and Elec Atten set to 10 dB. New total attenuation equals the value before Elec Atten enabled.
- Mech Atten at 0 dB. Elec Atten enabled, Mech Atten set to 10 dB, and Elec Atten set to 0 dB. New total attenuation does not equal the value before Elec Atten enabled.
- Mech Atten at 40 dB. Elec Atten enabled, Mech Atten set to 10 dB, and Elec Atten set to 24 dB. New total attenuation does not equal the value before Elec Atten enabled.

When the Electronic Attenuation is disabled:

- In the dual attenuator configuration, the Elec Atten key is grayed out (it never displays in the single attenuator configuration)
- The Auto/Man state of (Mech) Atten is restored
- If now in Auto, (Mech) Atten recouples
- If now in Man, (Mech) Atten is set to the value of total attenuation that existed before the Elec Atten was disabled. The resulting value is rounded up to the smallest value possible given the (Mech) Atten Step setting - (That is, 57 dB changes to 58 dB when (Mech) Atten Step is 2 dB.)

AMPTD Y Scale

Using the Electronic Attenuator: Pros and Cons

The electronic attenuator offers finer steps than the mechanical attenuator, has no acoustical noise, is faster, and is less subject to wear.

The “finer steps” advantage of the electronic attenuator is beneficial in optimizing the alignment of the analyzer dynamic range to the signal power in the front panel as well as remote use. Thus, you can achieve improved relative signal measurement accuracy. Compared to a mechanical attenuator with 2 dB steps, the 1 dB resolution of the electronic attenuator only gives better resolution when the odd-decibel steps are used. Those odd-decibel steps are less accurately calibrated than the even-decibel steps, so one trade off for this superior relative accuracy is reduced absolute amplitude accuracy.

Another disadvantage of the electronic attenuator is that the spectrum analyzer loses its “Auto” setting, making operation less convenient.

Also, the relationship between the dynamic range specifications (TOI, SHI, compression and noise) and instrument performance are less well-known with the electrical attenuator. With the mechanical attenuator, TOI, SHI and compression threshold levels increase dB-for-dB with increasing attenuation, and the noise floor does as well. With the electronic attenuator, there is an excess attenuation of about 1 to 3 dB between 0 and 3.6 GHz, making the effective TOI, SHI, and so forth, less well known. Excess attenuation is the actual attenuation relative to stated attenuation. Excess attenuation is accounted for in the analyzer calibration

Elec Atten

Controls the Electronic Attenuator in dual attenuator configurations. This key does not appear in single attenuator configurations, as the control of both the mechanical and electronic stages of the single attenuator is integrated into the single **Atten** key.

Key Path	AMPTD Y Scale, Attenuation
Remote Command	<code>[:SENSE] :POWER[:RF] :EATTenuation <rel_ampl></code> <code>[:SENSE] :POWER[:RF] :EATTenuation?</code>
Notes	Electronic Attenuation’s spec is defined only when Mechanical Attenuation is 6 dB.
Dependencies	This key only appears in the dual attenuator configuration. However, in the single attenuator configuration, EATT SCPI commands are accepted for compatibility with other X-series instruments and set a “soft” attenuation as described in “Attenuator Configurations and Auto/Man” on page 913 . The “soft” attenuation is treated as an addition to the “main” attenuation value set by the Atten softkey or the POW:ATT SCPI command and affects the total attenuation displayed on the Attenuation key and the Meas Bar. When Enable Elec Atten is off, the Elec Atten key is grayed out.
Preset	0 dB
State Saved	Saved in instrument state
Min	0 dB

Max	Dual attenuator configuration: 24 dB Single attenuator configuration: the total of ATT and EATT cannot exceed 50 dB, so if the EATT is set to 24 dB first, the main attenuation cannot be greater than 26 dB and will be reduced accordingly; if the main attenuator is set to 40 dB first, EATT cannot be greater than 10 dB
Initial S/W Revision	Prior to A.02.00
Modified at S/W Revision	A.03.00

Adjust Atten for Min Clip

Sets the combination of mechanical and electronic attenuation based on the current measured signal level so that clipping will be at a minimum.

This is an "immediate action" function, that is, it executes once, when the key is pressed.

This key is grayed out in measurements that do not support this functionality. The spectrum analyzer measurement, Swept SA, does not support this functionality.

Key Path	AMPTD Y Scale, Attenuation
Remote Command	[:SENSe] :POWer [:RF] :RANGe:OPTimize IMMEDIATE
Initial S/W Revision	Prior to A.02.00
Modified at S/W Revision	A.03.00

Pre-Adjust for Min Clip

If this function is on, it does the adjustment described under [“Adjust Atten for Min Clip” on page 917](#) each time a measurement restarts. Therefore, in Continuous measurement mode, it only executes before the first measurement.

In dual attenuator models, you can set **Elec+Mech Atten**, in which case both attenuators participate in the autoranging, or **Elec Atten Only**, in which case the mechanical attenuator does not participate in the autoranging. This latter case results in less wear on the mechanical attenuator and is usually faster.

This key is grayed out in measurements that do not support this functionality. The spectrum analyzer measurement, Swept SA, does not support this functionality.

Key Path	AMPTD Y Scale, Attenuation
Remote Command	[:SENSe] :POWer [:RF] :RANGe:OPTimize:ATTenuation OFF ELECTrical COMBined [:SENSe] :POWer [:RF] :RANGe:OPTimize:ATTenuation?
Notes	The SCPI parameter ELECTrical sets this function to On in single attenuator models. The SCPI parameter COMBined is mapped to ELECTrical in single attenuator models; if you send COMBined, it sets the function to On and returns ELEC to a query.
Preset	OFF for Swept SA measurement; ON for all other measurements that support Pre-Adjust for Min Clip

AMPTD Y Scale

State Saved	Saved in instrument state
Range	Dual attenuator models: Off Elec Atten Only Mech + Elec Atten Single attenuator models: Off On
Initial S/W Revision	Prior to A.02.00
Modified at S/W Revision	A.03.00

Remote Command	[:SENSE] :POWER[:RF] :RANGE:AUTO ON OFF 1 0 [:SENSE] :POWER[:RF] :RANGE:AUTO?
Notes	ON aliases to "Elec Atten Only" OFF aliases to "Off" The query returns true if not "Off"
Initial S/W Revision	Prior to A.02.00

(Mech) Atten Step

This controls the step size used when making adjustments to the input attenuation.

This key is labeled **Mech Atten Step** in dual attenuator models and **Atten Step** in single attenuator models. In the dual attenuator configuration, this key only affects the step size of the mechanical attenuator.

Key Path	AMPTD Y Scale, Attenuation
Remote Command	[:SENSE] :POWER[:RF] :ATTenuation:STEP[:INCREMENT] 10 dB 2 dB [:SENSE] :POWER[:RF] :ATTenuation:STEP[:INCREMENT] ?
Example	POW:ATT:STEP 2
Notes	This feature works like a 1-N choice from the front panel, but it takes a specific value (in dB) when used remotely. The only valid values are 2 and 10.
Dependencies	Blanked in CXA and EXA if option FSA (2 dB steps) is not present. If blanked, attempts to set it via SCPI will yield an "Option not present" error.
Couplings	When the attenuation step size changes, the current mechanical attenuation value is adjusted (if necessary) to be quantized to the new step size. That is, if step is set to 10 dB, mech atten is increased if necessary so it is a multiple of 10 dB
Preset	PXA and MXA: 2 dB EXA and CXA: 10 dB (2 dB with option FSA)
State Saved	Saved in instrument state

Initial S/W Revision	Prior to A.02.00
Modified at S/W Revision	A.03.00

Max Mixer Level

Controls the limitation on the Ref Level for a given attenuation setting, and therefore also interacts with the Auto rules for selecting the attenuation as a coupling from the reference level.

Key Path	AMPTD Y Scale, Attenuation
Remote Command	[:SENSE] :POWER [:RF] :MIXer :RANGe [:UPPer] <real> [:SENSE] :POWER [:RF] :MIXer :RANGe [:UPPer] ?
Example	POW:MIX:RANG -15 dBm
Preset	-10 dBm
State Saved	Saved in instrument state
Min	-50 dBm
Max	-10 dBm
Initial S/W Revision	Prior to A.02.00
Default Unit	Depends on the current selected Y axis unit, see Swept SA discussion of Y Axis Unit

Range

This key is only available when I/Q is the selected input. It replaces the Attenuation key in that case.

Each input channel (I and Q) has four internal gain ranges. The maximum allowed voltage in each gain range is slightly more than the nominal value, so the break point between ranges is a couple of millivolts higher than the nominal (setting a peak voltage of 0.502 mV will still map to the 0.5 V Peak range).

Gain Setting	Volts RMS	Volts Peak	Volts Peak - Peak	dBm (50W)	Break Point
0 dB	0.7071	1.0	2.0	10	n/a
6 dB	0.3536	0.5	1.0	4	0.502 V Peak
12 dB	0.1768	0.25	0.5	-2	0.252 V Peak
18 dB	0.0884	0.125	0.25	-8	0.127 V Peak

Key Path	AMPTD Y Scale
Notes	Visible only when the selected input is I/Q.
State Saved	No

AMPTD Y Scale

Readback Text	When Range is Auto, "[Auto]" When Range is Man and I & Q are the same, "[<range value>]" When Range is Man and I & Q are different: "[I: <I range value> Q: <Q range value>]" See I Range and Q Range for the <range value> enumeration definition.
Initial S/W Revision	Prior to A.02.00

Range Auto/Man

The Auto setting for Range causes the range to be set based on the Y Scale settings. When Range is “Auto”, the I & Q Range are set based on the top of the Y Scale when the Y scale is in dB units (for example, power), or to the max(abs(top), abs(bottom)) when the Y scale reference is not at the top of the screen.

Not all measurements support Range Auto/Man. If Auto is not supported in the current measurement, this key is grayed out and shows “Man” and MAN is returned to a SCPI query; but this does NOT change the Auto/Man setting for Range. When you go to a measurement that supports Auto, it goes back to Auto if it was previously in Auto mode.

Key Path	AMPTD Y Scale, Range
Scope	Meas Global
Remote Command	[:SENSe] :VOLTage:IQ:RANGe:AUTO OFF ON 0 1 [:SENSe] :VOLTage:IQ:RANGe:AUTO?
Example	Put the I Range and Q Range in manual. VOLT:IQ:RANG:AUTO OFF
Dependencies	If Auto is not supported, sending the SCPI command will generate an error.
Couplings	When in Auto, both I Range and Q Range are set to the same value, computed as follows: Maximum absolute value is computed for the Y Scale. The top and bottom of the graph are computed based on Ref Value, Scale/Div, and Ref Position. Formula: YMax = max(abs(top), abs(bottom)). The I Range and Q Range are then set to YMax.
Preset	ON
State Saved	Saved in instrument state
Range	Auto Man
Initial S/W Revision	Prior to A.02.00

Remote Command	[:SENSE] :POWER: IQ:RANGe:AUTO OFF ON 0 1 [:SENSE] :POWER: IQ:RANGe:AUTO?
Example	Put the I Range and Q Range in manual. POW:IQ:RANG:AUTO OFF
Notes	The POW:IQ:RANG:AUTO is an alternate form of the VOLT:IQ:RANG:AUTO command. This is to maintain consistency with I Range and Q Range, which support both the POWER and VOLTage forms of the command.
Preset	ON
Range	Auto Man
Initial S/W Revision	Prior to A.02.00

I Range

This is the internal gain range for the I channel when Input Path is I Only or Ind I/Q, and it is used for both the I and Q channels when the Input Path is I+jQ. See [“I/Q Gain Ranges” on page 924](#)I/Q Gain Ranges.

Key Path	AMPTD Y Scale, Range
Remote Command	[:SENSE] :VOLTage: IQ[:I] :RANGe[:UPPer] <voltage> [:SENSE] :VOLTage: IQ[:I] :RANGe[:UPPer] ?
Example	Set the I Range to 0.5 V Peak VOLT:IQ:RANG 0.5 V
Notes	The numeric entries are mapped to the smallest gain range whose break point is greater than or equal to the value, or 1 V Peak if the value is greater than 1 V.
Couplings	When Q Same as I is On, the I Range value will be copied to the Q Range. Changing the value will also set Range = Man.
Preset	1 V Peak
State Saved	Saved in instrument state
Range	1 V Peak 0.5 V Peak 0.25 V Peak 0.125 V Peak
Initial S/W Revision	Prior to A.02.00

Remote Command	[:SENSE] :POWER: IQ[:I] :RANGe[:UPPer] <ampl> [:SENSE] :POWER: IQ[:I] :RANGe[:UPPer] ?
Example	Set the I Range to 0.5 V Peak when Reference Z is 50Ω, and to 1.0 V Peak when Reference Z is 75Ω. POW:IQ:RANG 4 dBm

AMPTD Y Scale

Notes	<p>The POWER form of the command is provided for convenience. It maps to the same underlying gain range parameter as the VOLTage form of the command.</p> <p>The Reference Z (not the I channel Input Z) is used to convert the power to peak voltage, which is then used to set the I Range as with the VOLTage form of the command. The power values of the 4 range states (1V Peak, 0.5V Peak, 0.25V Peak, and 0.125V Peak) will vary with Reference Z. Here are some examples:</p> <p>50Ω: 10, 4, -2, -8</p> <p>75Ω: 8.2, 2.2, -3.8, -9.8</p> <p>600Ω: -0.8, -6.8, -12.8, -18.9</p>
Preset	10.0 dBm
Range	-20 dBm to 10 dBm
Min	-20 dBm
Max	10 dBm
Initial S/W Revision	Prior to A.02.00

Q Range

Accesses the Q Range menu.

Key Path	AMPTD Y Scale, Range
Readback Text	<p>Q Same as I 1 V Peak 0.5 V Peak 0.25 V Peak 0.125 V Peak</p> <p>When Q Same as I is On, the readback is "Q Same as I", otherwise it is the Q Range value.</p>
Initial S/W Revision	Prior to A.02.00

Q Same as I

Many, but not all, usages require the I and Q channels to have an identical setup. To simplify channel setup, the Q Same as I will cause the Q channel range to be mirrored from the I channel. That way you only need to set up one channel (the I channel). The I channel values are copied to the Q channel, so at the time Q Same as I is Off, the I and Q channel setups will be identical.

Key Path	AMPTD Y Scale, Range, Q Range
Remote Command	<p>[:SENSE] :VOLTage POWER: IQ: MIRRored OFF ON 0 1</p> <p>[:SENSE] :VOLTage POWER: IQ: MIRRored?</p>
Example	<p>Turn off the mirroring of I Range to Q Range.</p> <p>VOLT:IQ:MIRR OFF</p> <p>POW:IQ:MIRR OFF</p>
Couplings	When On, the I Range value is mirrored (copied) to the Q Range.

Preset	On
State Saved	Saved in instrument state.
Range	On Off
Readback Text	"Q Same as I" when On, otherwise none.
Initial S/W Revision	Prior to A.02.00

Q Range Value

This is the internal gain range for the Q channel. See “[I/Q Gain Ranges](#)” on page 924. I/Q Gain Ranges. The Q Range only applies to Input Path Q Only and Ind I/Q. For input I+jQ the I Range determines both I and Q channel range settings.

Key Path	AMPTD Y Scale, Range
Remote Command	[:SENSE] :VOLTage:IQ:Q:RANGE [:UPPer] <voltage> [:SENSE] :VOLTage:IQ:Q:RANGE [:UPPer] ?
Example	Set the Q Range to 0.5 V Peak VOLT:IQ:Q:RANG 0.5 V
Notes	The numeric entries are mapped to the smallest gain range whose break point is greater than or equal to the value, or 1 V Peak if the value is greater than 1 V. The Q Range is only used for Input Path Q Only and Ind I/Q. For input I+jQ the I Range determines both I and Q channel range settings.
Couplings	When Q Same as I is On, the I Range value will be copied to the Q Range and the range value keys are disabled. Changing the value will also set Range = Man.
Preset	1 V Peak
State Saved	Saved in instrument state
Range	1 V Peak 0.5 V Peak 0.25 V Peak 0.125 V Peak
Initial S/W Revision	Prior to A.02.00

Remote Command	[:SENSE] :POWER:IQ:Q:RANGE [:UPPer] <ampl> [:SENSE] :POWER:IQ:Q:RANGE [:UPPer] ?
Example	Will set the Q Range to 0.5 V Peak when Reference Z is 50Ω, and to 1.0 V Peak when Reference Z is 75Ω POW:IQ:Q:RANG 4 dBm

AMPTD Y Scale

Notes	<p>The POWER form of the command is provided for convenience. It maps to the same underlying gain range parameter as the VOLTage form of the command.</p> <p>The Reference Z (not the Q channel Input Z) is used to convert the power to peak voltage, which is then used to set the Q Range as with the VOLTage form of the command. The power values of the 4 range states (1V Peak, 0.5V Peak, 0.25V Peak, and 0.125V Peak) will vary with Reference Z. Here are some examples:</p> <p>50Ω: 10, 4, -2, -8</p> <p>75Ω: 8.2, 2.2, -3.8, -9.8</p> <p>600Ω: -0.8, -6.8, -12.8, -18.9</p>
Preset	10.0 dBm
Range	-20 dBm to 10 dBm
Min	-20 dBm
Max	10 dBm
Initial S/W Revision	Prior to A.02.00

I/Q Gain Ranges

1 V Peak

Set the channel gain state to 1 Volt Peak.

Key Path	AMPTD Y Scale, I Range Q Range
Initial S/W Revision	Prior to A.02.00

0.5 V Peak

Set the channel gain state to 0.5 Volt Peak.

Key Path	AMPTD Y Scale, I Range Q Range
Initial S/W Revision	Prior to A.02.00

0.25 V Peak

Set the channel gain state to 0.25 Volt Peak.

Key Path	AMPTD Y Scale, I Range Q Range
Initial S/W Revision	Prior to A.02.00

0.125 V Peak

Set the channel gain state to 0.125 Volt Peak.

Key Path	AMPTD Y Scale, I Range Q Range
----------	---

Initial S/W Revision	Prior to A.02.00
----------------------	------------------

Scale / Div

Sets the units per vertical graticule division on the display. This function is only available when Scale Type (Log) is selected and the vertical scale is power. When Scale Type (Lin) is selected, Scale/Div is grayed out.

Key Path	AMPTD Y Scale
Remote Command	:DISPlay:WINDow[1]:TRACe:Y[:SCALe]:PDIVision <rel_ampl> :DISPlay:WINDow[1]:TRACe:Y[:SCALe]:PDIVision?
Example	DISP:WIND:TRAC:Y:PDIV 5 DB
Dependencies	Scale/Div is grayed out in linear Y scale. Sending the equivalent SCPI command does change the Scale/Div, though it has no affect while in Lin.
Preset	10.00 dB / Div
State Saved	Saved in instrument state
Min	0.10 dB
Max	20 dB
Initial S/W Revision	Prior to A.02.00

Scale Type

Chooses a linear or logarithmic vertical scale for the display and for remote data readout.

When Scale Type (Log) is selected, the vertical graticule divisions are scaled in logarithmic units. The top line of the graticule is the Reference Level and uses the scaling per division Scale/Div to assign values to the other locations on the graticule.

When Scale Type (Lin) is selected, the vertical graticule divisions are linearly scaled with the reference level value at the top of the display and zero volts at the bottom. Each vertical division of the graticule represents one-tenth of the Reference Level.

NOTE The Y Axis Unit used for each type of display is set by pressing Y Axis Unit. The analyzer remembers separate Y Axis Unit settings for both Log and Lin.

Key Path	AMPTD Y Scale
Remote Command	:DISPlay:WINDow[1]:TRACe:Y[:SCALe]:SPACing LINear LOGarithmic :DISPlay:WINDow[1]:TRACe:Y[:SCALe]:SPACing?

AMPTD Y Scale

Example	DISP:WIND:TRAC:Y:SPAC LOG DISP:WIND:TRAC:Y:SPAC?
Dependencies	If Normalize is on, Scale Type forced to Log and is grayed out.
Couplings	Changing the Scale Type always sets the Y Axis unit to the last unit specified for the current amplitude scale. In other words, we restore the Y Axis unit setting appropriate per log/lin.
Preset	LOG
State Saved	Saved in instrument state
Initial S/W Revision	Prior to A.02.00

Presel Center

When this key is pressed, the centering of the preselector filter is adjusted to optimize the amplitude accuracy at the frequency of the selected marker. If the selected marker is not on when Presel Center is pressed, the analyzer will turn on the selected marker, perform a peak search, and then perform centering on the marker's center frequency. If the selected marker is already on and between the start and stop frequencies of the analyzer, the analyzer performs the preselector calibration on that marker's frequency. If the selected marker is already on, but outside the frequency range between Start Freq and Stop Freq, the analyzer will first perform a peak search, and then perform centering on the marker's center frequency.

The value displayed on the **Presel Adjust** key will change to reflect the new preselector tuning (see **Presel Adjust**).

A number of considerations should be observed to ensure proper operation. See [“Proper Preselector Operation” on page 927](#).

Key Path	AMPTD Y Scale
Remote Command	[:SENSE] :POWER [:RF] :PCENTER
Example	POW:PCEN
Notes	Note that the rules outlined above under the key description apply for the remote command as well as the key. The result of the command is dependent on marker position, and so forth. Any message shown by the key press is also shown in response to the remote command.
Dependencies	<ul style="list-style-type: none"> • Grayed out if the microwave preselector is off.) • If the selected marker's frequency is below Band 1, advisory 0.5001 is generated and no action is taken. • Grayed out if entirely in Band 0. • Blank in models that do not include a preselector, such as option 503. If the SCPI is sent in these instruments, it is accepted without error, and the query always returns 0.

Couplings	The active marker position determines where the centering will be attempted. If the analyzer is in a measurement such as averaging when centering is initiated, the act of centering the preselector will restart averaging but the first average trace will not be taken until the centering is completed.
Status Bits/OPC dependencies	When centering the preselector, *OPC will not return true until the process is complete and a subsequent measurement has completed, nor will results be returned to a READ or MEASure command. The Measuring bit should remain set while this command is operating and should not go false until the subsequent sweep/measurement has completed.
Initial S/W Revision	Prior to A.02.00
Modified at S/W Revision	A.03.00

Proper Preselector Operation

A number of considerations should be observed to ensure proper operation:

If the selected marker is off, the analyzer will turn on a marker, perform a peak search, and adjust the preselector using the selected marker's frequency. It uses the "highest peak" peak search method unqualified by threshold or excursion, so that there is no chance of a 'no peak found' error. It continues with that peak, even if it is the peak of just noise. Therefore, for this operation to work properly, there should be a signal on screen in a preselected range for the peak search to find.

If the selected marker is already on, the analyzer will attempt the centering at that marker's frequency. There is no preselector for signals below about 3.6 GHz, therefore if the marker is on a signal below 3.6 GHz, no centering will be attempted and an advisory message generated

In some models, the preselector can be bypassed. If it is bypassed, no centering will be attempted in that range.

Preselector Adjust

Allows you to manually adjust the preselector filter frequency to optimize its response to the signal of interest. This function is only available when "Presel Center" on page 926 is available.

For general purpose signal analysis, using Presel Center is recommended. Centering the filter minimizes the impact of long-term preselector drift. Presel Adjust can be used instead to manually optimize the preselector. One application of manual optimization would be to peak the preselector response, which both optimizes the signal-to-noise ratio and minimizes amplitude variations due to small (short-term) preselector drifting.

Key Path	AMPTD Y Scale
Scope	Meas Global
Remote Command	[:SENSe] :POWer [:RF] :PADJust <freq> [:SENSe] :POWer [:RF] :PADJust?

AMPTD Y Scale

Example	POW:PADJ 100KHz POW:PADJ?
Notes	The value on the key reads out to 0.1 MHz resolution.
Dependencies	<ul style="list-style-type: none"> • Grayed out if microwave preselector is off.) • Grayed out if entirely in Band 0. • Blank in models that do not include a preselector, such as option 503. If the SCPI is sent in these instruments, it is accepted without error, and the query always returns 0.
Preset	0 MHz
State Saved	The Presel Adjust value set by Presel Center , or by manually adjusting Presel Adjust , is not saved in Instrument State, and does not survive a Preset or power cycle.
Min	-500 MHz
Max	500 MHz
Backwards Compatibility SCPI	[:SENSe]:POWer[:RF]:MW:PADJust [:SENSe]:POWer[:RF]:MMW:PADJust (These were undocumented commands for PSA which X-Series will accept)
Initial S/W Revision	Prior to A.02.00
Modified at S/W Revision	A.03.00
Default Unit	Hz

Remote Command	[:SENSe]:POWer[:RF]:PADJust:PRESelector MWAVe MMWave EXTernal [:SENSe]:POWer[:RF]:PADJust:PRESelector?
Notes	[:SENSe]:POWer[:RF]:PADJust:PRESelector MWAVe MMWave EXTernal where: MWAV = 3–26 GHz MMWave = 26–50 GHz EXTernal = External Preselector Selection - PSA had multiple preselectors, and you could select which preselector to center. Since the X-Series will have only one preselector, the preselector selection softkey will no longer be available. However, in order to provide backward compatibility, we will support the remote command. The command form is a NOP The query will return MWAVE
Initial S/W Revision	Prior to A.02.00

Y Axis Unit

Displays the menu keys that enable you to change the vertical (Y) axis amplitude unit. The analyzer retains the entered Y Axis Unit separately for both Log and Lin amplitude scale types. For example, if Scale Type has been set to Log, and you set Y Axis Unit to dBm, pressing Scale Type (Log) sets the Y Axis Unit to dBm. If Scale Type has been set to Lin and you set Y Axis Unit to V, pressing Scale Type (Lin) sets the Y Axis Unit to V. Pressing Scale Type (Log) again sets the Y axis unit back to dBm.

NOTE	<p>The units of current (A, dBmA, dBuA) are calculated based on 50 ohms input impedance.</p> <p>All four of the EMI units (dBμA/m, dBμV/m, dBG, dBpT) are treated by the instrument exactly as though they were dBuV. The user must load an appropriate correction factor using Amplitude Corrections for accurate and meaningful results.</p> <p>If a SCPI command is sent to the analyzer that uses one of the EMI units as a terminator, the analyzer treats it as though DBUV had been sent as the terminator.</p>
-------------	--

Key Path	AMPTD Y Scale
Mode	SA
Scope	Meas Global
Remote Command	:UNIT:POWer DBM DBMV DBMA V W A DBUV DBUA DBUVM DBUAM DBPT DBG :UNIT:POWer?
Example	UNIT:POW dBmV UNIT:POW?
Notes	The Y axis unit has either logarithmic or linear characteristics. The set of units that is logarithmic consists of dBm, dBmV, dBmA, dB μ V, dB μ A, dB μ V/m, dB μ A/m, dBpT, and dBG. The set if units that is linear consists of V, W, and A. The chosen unit will determine how the reference level and all the amplitude-related outputs like trace data, marker data, etc. read out.

AMPTD Y Scale

Notes	<p>The settings of Y Axis Unit and Scale Type, affect how the data is read over the remote interface. When using the remote interface no unit is returned, so you must know what the Y axis unit is to interpret the results:</p> <p>Example 1, set the following:</p> <p>Scale Type (Log) Y Axis Unit, dBm Scale/Div, 1 dB Ref Level, 10 dBm</p> <p>This sets the top line to 10 dBm with each vertical division representing 1 dB. Thus, if a point on trace 1 is on the fifth graticule line from the top, it represents 5 dBm and will read out remotely as 5.</p> <p>Example 2, set the following:</p> <p>Scale Type (Lin) Y Axis Unit, Volts Ref Level, 100 mV (10 mV/div)</p> <p>This sets the top line to 100 mV and the bottom line to 0 V, so each vertical division represents 10 mV. Thus, if a point on trace 1 is on the fifth graticule line from the top, it represents 50 mV and will read out remotely as 50.</p>
Dependencies	<p>If an amplitude correction with an Antenna Unit other than None is applied and enabled, then that antenna unit is forced and the key with that unit is the only Y Axis Unit available. All other Y Axis Unit keys are grayed out.</p> <p>If an amplitude correction with an Antenna Unit other than None is applied and enabled, and you then turn off that correction or set Apply Corrections to No, the Y Axis Unit that existed before the Antenna Unit was applied is restored.</p>
Couplings	The analyzer retains the entered Y Axis Unit separately for both Log and Lin amplitude scale types
Preset	dBm for log scale, V for linear. The true 'preset' value is dBm, since at preset the Y Scale type is set to logarithmic.
State Saved	Saved in instrument state
Readback line	1-of-N selection
Initial S/W Revision	Prior to A.02.00
Modified at S/W Revision	A.02.00, A.04.00

dBm

Sets the amplitude unit for the selected amplitude scale (log/lin) to dBm.

Key Path	AMPTD Y Scale, Y Axis Unit
Example	UNIT:POW DBM

Dependencies	Grayed out if an Amplitude Correction with an Antenna Unit is ON.
Readback	dBm
Initial S/W Revision	Prior to A.02.00
Modified at S/W Revision	A.02.00

dBmV

Sets the amplitude unit for the selected amplitude scale (log/lin) to dBmV.

Key Path	AMPTD Y Scale, Y Axis Unit
Example	UNIT:POW DBMV
Dependencies	Grayed out if an Amplitude Correction with an Antenna Unit is ON.
Readback	dBmV
Initial S/W Revision	Prior to A.02.00
Modified at S/W Revision	A.02.00

dBmA

Sets the amplitude unit for the selected amplitude scale (log/lin) to dBmA.

Key Path	AMPTD Y Scale, Y Axis Unit
Example	UNIT:POW DBMA
Dependencies	Grayed out if an Amplitude Correction with an Antenna Unit is ON.
Readback	dBmA
Initial S/W Revision	Prior to A.02.00
Modified at S/W Revision	A.02.00

W

Sets the amplitude unit for the selected amplitude scale (log/lin) to watt.

Key Path	AMPTD Y Scale, Y Axis Unit
Example	UNIT:POW W
Dependencies	Grayed out if an Amplitude Correction with an Antenna Unit is ON.
Readback	W
Initial S/W Revision	Prior to A.02.00
Modified at S/W Revision	A.02.00

AMPTD Y Scale

V

Sets the amplitude unit for the selected amplitude scale (log/lin) to volt.

Key Path	AMPTD Y Scale, Y Axis Unit
Example	UNIT:POW V
Dependencies	Grayed out if an Amplitude Correction with an Antenna Unit is ON.
Readback	V
Initial S/W Revision	Prior to A.02.00
Modified at S/W Revision	A.02.00

A

Sets the amplitude unit for the selected amplitude scale (log/lin) to Ampere.

Key Path	AMPTD Y Scale, Y Axis Unit
Example	UNIT:POW A
Dependencies	Grayed out if an Amplitude Correction with an Antenna Unit is ON.
Readback	A
Initial S/W Revision	Prior to A.02.00
Modified at S/W Revision	A.02.00

dB μ V

Sets the amplitude unit for the selected amplitude scale (log/lin) to dB μ V.

Key Path	AMPTD Y Scale, Y Axis Unit
Example	UNIT:POW DBUV
Dependencies	Grayed out if an Amplitude Correction with an Antenna Unit is ON.
Readback	dB μ V
Initial S/W Revision	Prior to A.02.00
Modified at S/W Revision	A.02.00

dB μ A

Sets the amplitude unit for the selected amplitude scale (log/lin) to dB μ A.

Key Path	AMPTD Y Scale, Y Axis Unit
Example	UNIT:POW DBUA
Dependencies	Grayed out if an Amplitude Correction with an Antenna Unit is ON.

Readback	dB μ A
Initial S/W Revision	Prior to A.02.00
Modified at S/W Revision	A.02.00

dB μ V/m

Sets the amplitude unit for the selected amplitude scale (log/lin) to dB μ V/m. This is an antenna unit, and this key is grayed out unless a Correction with this Antenna Unit selected is ON. If this is the case, all of the other Antenna Units are grayed out.

Key Path	AMPTD Y Scale, Y Axis Unit
Example	UNIT:POW DBUVM
Dependencies	Grayed out if no Amplitude Correction with an Antenna Unit is on.
Readback	dB μ V/m
Initial S/W Revision	A.02.00

dB μ A/m

Sets the amplitude unit for the selected amplitude scale (log/lin) to dB μ A/m. This is an antenna unit, and this key is grayed out unless a Correction with this Antenna Unit selected is ON. If this is the case, all of the other Antenna Units are grayed out.

Key Path	AMPTD Y Scale, Y Axis Unit
Example	UNIT:POW DBUAM
Dependencies	Grayed out if no Amplitude Correction with an Antenna Unit is on.
Readback	dB μ A/m
Initial S/W Revision	A.02.00

dBpT

Sets the amplitude unit for the selected amplitude scale (log/lin) to dBpT. This is an antenna unit, and this key is grayed out unless a Correction with this Antenna Unit selected is ON. If this is the case, all of the other Antenna Units are grayed out.

Key Path	AMPTD Y Scale, Y Axis Unit
Example	UNIT:POW DBPT
Dependencies	Grayed out if no Amplitude Correction with an Antenna Unit is on.
Readback	dBpT
Initial S/W Revision	A.02.00

AMPTD Y Scale

dBG

Sets the amplitude unit for the selected amplitude scale (log/lin) to dBG. This is an antenna unit, and this key is grayed out unless a Correction with this Antenna Unit selected is ON. If this is the case, all of the other Antenna Units are grayed out.

Key Path	AMPTD Y Scale, Y Axis Unit
Example	UNIT:POW DBG
Dependencies	Grayed out if no Amplitude Correction with an Antenna Unit is on.
Readback	dBG
Initial S/W Revision	A.02.00

Reference Level Offset

Adds an offset value to the displayed reference level. The reference level is the absolute amplitude represented by the top graticule line on the display.

See [“More Information” on page 934](#)

Key Path	AMPTD Y Scale
Mode	SA
Scope	Meas Global
Remote Command	:DISPlay:WINDow[1]:TRACe:Y[:SCALe]:RLEVel:OFFSet <rel_ampl> :DISPlay:WINDow[1]:TRACe:Y[:SCALe]:RLEVel:OFFSet?
Example	DISP:WIND:TRAC:Y:RLEV:OFFS 12.7 Sets the Ref Level Offset to 12.7 dB. The only valid suffix is dB. If no suffix is sent, dB will be assumed.
Preset	0 dBm
State Saved	Saved in instrument state
Min	The range for Ref Lvl Offset is variable. It is limited to values that keep the reference level within the range of -327.6 dB to 327.6 dB.
Max	327.6 dB
Initial S/W Revision	Prior to A.02.00
Modified at S/W Revision	A.04.00

More Information

Offsets are used when gain or loss occurs between a device under test and the analyzer input. Thus, the signal level measured by the analyzer may be thought of as the level at the input of an external amplitude conversion device. Entering an offset does not affect the trace position or attenuation value, just the value

of the top line of the display and the values represented by the trace data. Thus, the values of exported trace data, queried trace data, marker amplitudes, trace data used in calculations such as N dB points, trace math, peak threshold, and so forth, are all affected by Ref Level Offset.

NOTE Changing the offset causes the analyzer to immediately stop the current sweep and prepare to begin a new sweep, but the data will not change until the trace data updates, because the offset is applied to the data as it is taken. If a trace is exported with a nonzero Ref Level Offset, the exported data will contain the trace data with the offset applied.

The maximum reference level available is dependent on the reference level offset. That is, Ref Level - Ref Level Offset must be in the range -170 to $+30$ dBm. For example, the reference level value range can be initially set to values from -170 dBm to 30 dBm with no reference level offset. If the reference level is first set to -20 dBm, then the reference level offset can be set to values of -150 to $+50$ dB.

If the reference level offset is first set to -30 dB, then the reference level can be set to values of -200 dBm to 0 dBm. In this case, the reference level is “clamped” at 0 dBm because the maximum limit of $+30$ dBm is reached with a reference level setting of 0 dBm with an offset of -30 dB. If instead, the reference level offset is first set to 30 dB, then the reference level can be set to values of -140 to $+60$ dBm.

μW Path Control

The **μW Path Control** functions include the **μW Preselector Bypass** (Option MPB) and **Low Noise Path** (Option LNP) controls in the High Band path circuits.

When the μW Preselector is bypassed, the user has better flatness, but will be subject to spurs from out of band interfering signals. When the Low Noise Path is enabled, the analyzer automatically switches around certain circuitry in the high frequency bands which can contribute to noise, when it is appropriate based on other analyzer settings.

For most applications, the preset state is Standard Path, which gives the best remote-control throughput, minimizes acoustic noise from switching and minimizes the risk of wearout in the hardware switches. For applications that utilize the wideband IF paths, the preset state is the μW Preselector Bypass path, if option MPB is present. This is because, when using a wideband IF such as the 140 MHz IF, the μW Preselector’s bandwidth can be narrower than the available IF bandwidth, causing degraded amplitude flatness and phase linearity, so it is desirable to bypass the preselector in the default case.

Users may choose Low Noise Path Enable. It gives a lower noise floor, especially in the 21 – 26.5 GHz region, though without improving many measures of dynamic range, and without giving the best possible noise floor. The preamp, if purchased and used, gives better noise floor than does the Low Noise Path, however its compression threshold and third-order intercept are much poorer than that of the non-preamp Low Noise Path. There are some applications, typically for signals around 30 dBm, for which the third-order dynamic range of the standard path is good enough, but the noise floor is not low enough even with 0 dB input attenuation. When the third-order dynamic range of the preamp path is too little and the noise floor of the standard path is too high, the Low Noise Path can provide the best dynamic range.

Key Path	AMPTD Y Scale
----------	---------------

AMPTD Y Scale

Mode	SA, BASIC, PNOISE, VSA
Scope	Meas Global
Remote Command	[:SENSE] :POWER [:RF] :MW:PATH STD LNPath MPBypass FULL [:SENSE] :POWER [:RF] :MW:PATH?
Example	:POW:MW:PATH LNP Enables the Low Noise path
Notes	<p>If a Presel Center is performed, the analyzer will momentarily switch to the Standard Path, regardless of the setting of µW Path Control</p> <p>The DC Block will always be switched in when the low noise path is switched in, to protect succeeding circuitry from DC. Note that this does not mean “when the low noise path is enabled” but when, based on the Low Noise Path rules, the path is actually switched in. This can happen when the selection is Low Noise Path Enable. In the case where the DC Block is switched in the analyzer is now AC coupled. However, if the user has selected DC coupling, the UI will still behave as though it were DC coupled, including all annunciation, warnings, status bits, and responses to SCPI queries. This is because, based on other settings, the analyzer could switch out the low noise path at any time and hence go back to being DC coupled.</p> <p>Alignment switching ignores the settings in this menu, and restores them when finished.</p>
Dependencies	Blanked in BBIQ,
Preset	All modes other than IQ Analyzer mode: STD IQ Analyzer mode: MPB option present and licensed: MPB MPB option not present and licensed: STD
State Saved	Save in instrument state
Readback	Value selected in the submenu
Initial S/W Revision	A.04.00

Standard Path

This path gives the best remote-control throughput, minimizes acoustic noise from switching and minimizes the risk of wear in the hardware switches, particularly in remote test scenarios where both low band and high band setups will follow in rapid succession.

In this path, the bypass of the low band/high band switch and microwave preamp is never activated, which can cause some noise degradation but preserves the life of the bypass switch.

Key Path	AMPTD Y Scale, µW Path Control
Example	:POW:MW:PATH STD
Readback Text	Standard Path
Initial S/W Revision	A.04.00

Low Noise Path Enable

You may choose Low Noise Path Enable, which gives a lower noise floor under some circumstances, particularly when operating in the 21–26.5 GHz region. With the Low Noise Path enabled, the low band/high band switch and microwave preamp are bypassed whenever all of the following are true:

- The analyzer is not in the Low Band, meaning:
- the start frequency is above 3.5 GHz and
- the stop frequency is above 3.6 GHz.
- the internal preamp is not installed or (if installed) is set to **Off** or **Low Band**

Note that this means that, when any part of a sweep is done in Low Band, the Low Noise Path is not used, whether or not the **Low Noise Path Enable** is selected in the user interface. Also, if the preamp is turned on, the Low Noise Path is not used, whether or not the **Low Noise Path Enable** is selected in the user interface. The only time the Low Noise Path is used is when **Low Noise Path Enable** is selected, the sweep is completely in High Band (> 3.6 GHz) and no preamp is in use.

See “[More Information](#)” on page 937

Key Path	AMPTD Y Scale, μW Path Control
Measurement	Swept SA
Example	:POW:MW:PATH LNP
Notes	<p>For measurements that use IQ acquisition, the low noise path is used when the Center Frequency is in High Band (> 3.6 GHz) and no preamp is in use.</p> <p>In other words, the rules above are modified to use only the center frequency to qualify which path to switch in.</p> <p>This is not the case for FFT’s in the Swept SA measurement; they use the same rules as swept measurements.</p>
Dependencies	<p>Key is blanked if current mode does not support it.</p> <p>Key is grayed out if mode supports it but current measurement does not support it.</p> <p>Unless Option LNP is present and licensed, key is blank and if SCPI command sent, error –241, "Hardware missing; Option not installed" is generated.</p>
Readback Text	Low Noise Path Enable
Initial S/W Revision	A.04.00

More Information

The user should understand that the Low Noise Path, while giving improved DANL, has the disadvantage of decreased TOI performance and decreased gain compression performance relative to the standard path.

The user should also understand that the bypass switch is a mechanical switch and has finite life; so if the **Low Noise Path** is enabled, it is possible to cause frequent cycling of this switch by frequently changing

AMPTD Y Scale

analyzer settings such that the above conditions hold true only some of the time. A user making tests of this nature should consider opting for the **Standard Path**, which will never throw the bypass switch, at the expense of some degraded noise performance.

The low noise path is useful for situations where the signal level is so low that the analyzer performance is dominated by noise even with 0 dB attenuation, but still high enough that the preamp option would have excessive third-order intermodulation or compression. The preamp, if purchased and used, gives better noise floor than does the “Low Noise Path.” However, its compression threshold and third-order intercept are much poorer than that of the non-preamp path. There are some applications, typically for signals around 30 dBm, for which the third-order dynamic range of the standard path is good enough, but the noise floor is not low enough even with 0 dB input attenuation. When the third-order dynamic range of the preamp path is too little and the noise floor of the standard path is too high, the Low Noise Path can provide the best dynamic range

The graph below illustrates the concept. It shows, in red, the performance of an analyzer at different attenuation settings, both with the preamp on and off, in a measurement that is affected by both analyzer noise and analyzer TOI. The green shows the best available dynamic range, offset by 0.5 dB for clarity. The blue shows how the best available dynamic range improves for moderate signal levels with the low noise path switched in. In this illustration, the preamp improves the noise floor by 15 dB while degrading the third-order intercept by 30 dB, and the low noise path reduces loss by 8 dB. The attenuator step size is 2 dB.

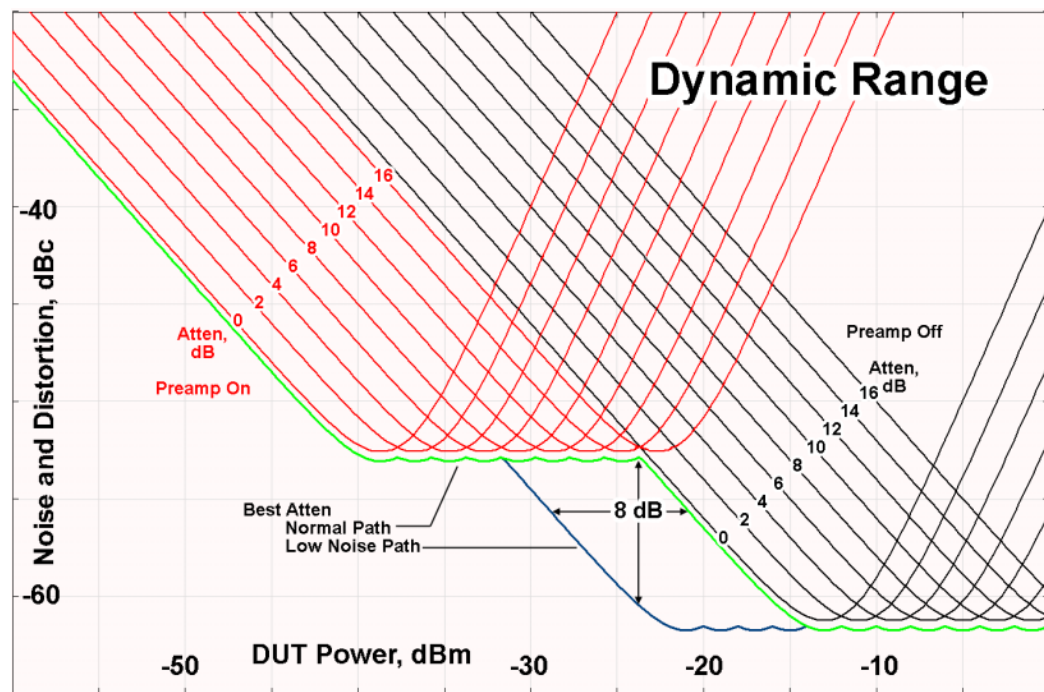

There are other times where selecting the low noise path improves performance, too. Compression-limited measurements such as finding the nulls in a pulsed-RF spectrum can profit from the low noise path in a way similar to the TOI-limited measurement illustrated. Accuracy can be improved when the low noise path allows the optimum attenuation to increase from a small amount like 0, 2 or 4 dB to a larger amount, giving better return loss at the analyzer input. Harmonic measurements, such as second and third harmonic levels, are much improved using the low noise path because of the superiority of that path for harmonic (though not intermodulation) distortion performance.

μW Preselector Bypass

This key toggles the preselector bypass switch for band 1 and higher. When the microwave preselect is on, the signal path is preselected. When the microwave preselector is off, the signal path is not preselected. The preselected path is the normal path for the analyzer.

The preselector is a tunable bandpass filter which prevents signals away from the frequency of interest from combining in the mixer to generate in-band spurious signals (images). The consequences of using a preselector filter are its limited bandwidth, the amplitude and phase ripple in its passband, and any amplitude and phase instability due to center frequency drift.

Option MPB or pre-selector bypass provides an unpreselected input mixer path for certain X-Series signal analyzers with frequency ranges above 3.6 GHz. This signal path allows a wider bandwidth and less amplitude variability, which is an advantage when doing modulation analysis and broadband signal analysis. The disadvantage is that, without the preselector, image signals will be displayed. Another disadvantage of bypassing the preselector is increased LO emission levels at the front panel input port.

Key Path	AMPTD Y Scale, μW Path Control
Example	:POW:MW:PATH MPB
Dependencies	Key is blanked if current mode does not support it. Key is grayed out if mode supports it but current measurement does not support it. Key is blank unless Option MPB is present and licensed. If SCPI command sent when MPB not present, error -241, "Hardware missing; Option not installed" is generated.
Readback Text	μW Preselector Bypass
Initial S/W Revision	A.04.00

Example	:POW:MW:PRES OFF Bypasses the microwave preselector
Preset	ON
Backwards Compatibility SCPI	[:SENSe]:POWer[:RF]:MW:PRESelector[:STATe] ON OFF 0 1 [:SENSe]:POWer[:RF]:MW:PRESelector[:STATe]?
Backwards Compatibility Notes	The ON parameter sets the STD path. The OFF parameter sets Path MPB.

Internal Preamp

Accesses a menu of keys that control the internal preamps. Turning on the preamp gives a better noise figure, but a poorer TOI to noise floor dynamic range. You can optimize this setting for your particular measurement.

The instrument takes the preamp gain into account as it sweeps. If you sweep outside of the range of the

AMPTD Y Scale

preamp the instrument will also account for that. The displayed result will always reflect the correct gain.

Key Path	AMPTD Y Scale
Scope	Meas Global
Remote Command	[:SENSE] :POWER [:RF] :GAIN [:STATe] OFF ON 0 1 [:SENSE] :POWER [:RF] :GAIN [:STATe] ?
Dependencies	Preamp is not available on all hardware platforms. If the preamp is not present or is unlicensed, the key is not shown. The preamp is not available when the electronic/soft attenuator is enabled.
Preset	OFF
State Saved	Saved in instrument state
Initial S/W Revision	Prior to A.02.00

Key Path	AMPTD Y Scale, Internal Preamp
Scope	Meas Global
Remote Command	[:SENSE] :POWER [:RF] :GAIN :BAND LOW FULL [:SENSE] :POWER [:RF] :GAIN :BAND ?
Dependencies	Preamp is not available on all hardware platforms. If the preamp is not present or is unlicensed, the key is not shown. If a POW:GAIN:BAND FULL command is sent when a low band preamp is available, the preamp band parameter is to LOW instead of FULL, and an "Option not installed" message is generated.
Preset	LOW
State Saved	Saved in instrument state
Initial S/W Revision	Prior to A.02.00

Off

Turns the internal preamp off

Key Path	AMPTD Y Scale, Internal Preamp
Example	:POW:GAIN OFF
Readback	Off
Initial S/W Revision	Prior to A.02.00

Low Band

Sets the internal preamp to use only the low band.

The frequency range of the installed (optional) low-band preamp is displayed in square brackets on the

Low Band key label.

Key Path	AMPTD Y Scale, Internal Preamp
Example	:POW:GAIN ON :POW:GAIN:BAND LOW
Readback	Low Band
Initial S/W Revision	Prior to A.02.00

Full Range

Sets the internal preamp to use its full range. The low band (0–3.6 GHz or 0–3GHz, depending on the model) is supplied by the low band preamp and the frequencies above low band are supplied by the high band preamp.

The frequency range of the installed (optional) preamp is displayed in square brackets on the **Full Range** key label. If the high band option is not installed the Full Range key does not appear.

Key Path	AMPTD Y Scale, Internal Preamp
Example	:POW:GAIN ON :POW:GAIN:BAND FULL
Readback	Full Range
Initial S/W Revision	Prior to A.02.00

AMPTD Y Scale

Auto Couple

The Auto Couple feature provides a quick and convenient way to automatically couple multiple instrument settings. This helps ensure accurate measurements and optimum dynamic range. When the Auto Couple feature is activated, either from the front panel or remotely, all parameters of the current measurement which have an Auto/Manual mode are set to Auto mode and all measurement settings dependent on (or coupled to) the Auto/Man parameters are automatically adjusted for optimal performance.

However, the Auto Couple key actions are confined to the current measurement only. It does not affect other measurements in the mode, and it does not affect markers, marker functions, or trace or display attributes.

See [“More Information” on page 943](#)

Key Path	Front-panel key
Remote Command	:COUPle ALL NONE
Example	:COUP ALL
Notes	:COUPle ALL puts all Auto/Man parameters in Auto mode (equivalent to pressing the Auto Couple key). :COUPLE NONE puts all Auto/Man parameters in manual mode. It decouples all the coupled instrument parameters and is not recommended for making measurements.
Initial S/W Revision	Prior to A.02.00

More Information

There are two types of functions that have Auto/Manual modes.

Auto/Man Active Function keys

An Auto/Man toggle key controls the binary state associated with an instrument parameter by toggling between "Auto" (where the parameter is automatically coupled to the other parameters it is dependent upon) and "Man" (where the parameter is controlled independent of the other parameters), as well as making the parameter the active function. The current mode is indicated on the softkey with either "Auto" or "Man" underlined as illustrated below.

Sweep Time	
66.24 ms	
<u>Auto</u>	Man

vsd07

Auto/Man 1-of-N keys

An Auto/Man 1-of-N key allows you to manually pick from a list of parameter values, or place the function in "Auto" in which case the value is automatically selected (and indicated) as shown below. If in Auto, Auto is underlined on the calling key. If in manual operation, manual is indicated on the calling key. But the calling key does not actually toggle the function, it simply opens the menu.

Auto Couple

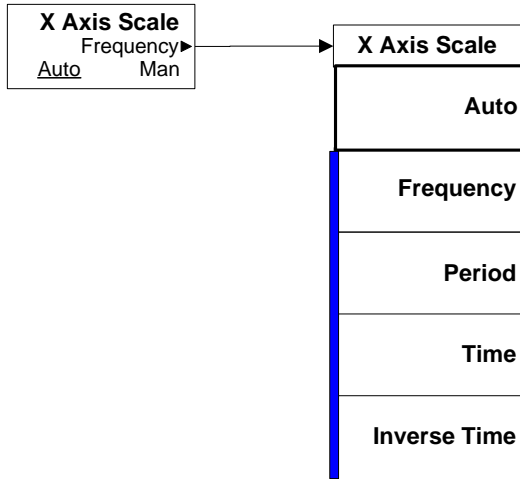

vsd08

BW

The BW key opens the bandwidth menu, which contains keys to control the Resolution Bandwidth and Video Bandwidth functions of the instrument.

The Resolution BW functions control filter bandwidth and filter type. There are two filter types, Gaussian and Flattop. The Gaussian filters have a response curve that is parabolic on a log scale. The Flattop filter shape is a close approximation of a rectangular filter.

NOTE The AVERAGE functions, which appeared in the BW menu in earlier analyzers, can now be found in the Trace menu and the Meas Setup menu. In the Trace menu, you may turn Trace Averaging on or off for the desired traces (rather than globally as in the past); and in the Meas Setup menu you may configure Averaging, by setting the Average Number and the Average Type.

Key Path	Front-panel key
Initial S/W Revision	Prior to A.02.00

Res BW

Activates the resolution bandwidth active function, which allows you to manually set the resolution bandwidth (RBW) of the analyzer. Normally, **Res BW** (Auto) selects automatic coupling of the Res BW to **Span** using the ratio set by the Span:3 dB RBW key. To decouple the resolution bandwidth, press Res BW until Man is underlined, or simply enter a different value for **Res BW**.

See [“More Information” on page 946](#)

Key Path	BW
Remote Command	[:SENSe]:BANDwidth BWIDth[:RESolution] <freq> [:SENSe]:BANDwidth BWIDth[:RESolution]? [:SENSe]:BANDwidth BWIDth[:RESolution]:AUTO OFF ON 0 1 [:SENSe]:BANDwidth BWIDth[:RESolution]:AUTO?
Example	BAND 1 KHZ BAND? BWID:AUTO ON BWID:AUTO?
Notes	For numeric entries, all RBW Types choose the nearest (arithmetically, on a linear scale, rounding up) available RBW to the value entered.
Notes	The setting and querying of values depends on the current bandwidth type.

BW

Dependencies	When in Zero Span with no EMI Standard selected, there is no Auto setting for Res BW. The Auto/Man line on the Res BW softkey disappears in this case, and if the SCPI command [:SENSe]:BWID[:RESolution]:AUTO ON is sent, it generates an error.
Couplings	Res BW is normally coupled to Span; if Res BW is set to Auto, as the Span decreases, so will the Res BW. Normally, in Zero Span, this coupling is turned off and Res BW has no Auto setting. When a CISPR or MIL EMI Standard is in use, the Res BW is coupled to Center Frequency and not to Span, and this is true even in Zero Span. Sweep time is coupled to RBW when in a non-zero span. If Sweep Time is set to Auto, then the sweep time is changed as the RBW changes, to maintain amplitude calibration. Video bandwidth (VBW) is normally coupled to RBW. If VBW is set to Auto, then the VBW is changed as the RBW changes, to maintain the ratio set by VBW:3 dB RBW. See the “ VBW:3dB RBW ” on page 948 key description.
Preset	3 MHz ON
State Saved	Saved in Instrument State
Min	1 Hz
Max	8 MHz is the max equivalent –3 dB RBW, which means that the named RBW (the one shown on the key etc) can actually exceed 8 MHz if using a filter other than –3 dB Gaussian
Initial S/W Revision	Prior to A.02.00
Default Unit	Hz

More Information

When the **Res BW** is manually selected, it may be returned to the coupled state by pressing the **Res BW** key until **Auto** is underlined. This may also be done by pressing Auto Couple or by performing a **Preset**.

When **Res BW** is set to **Auto**, the bandwidth selected depends on the Filter Type (see “Filter Type” below).

Only certain discrete resolution bandwidths are available. The available bandwidths are dependent on the **Filter Type** or the **EMC Standard**. If an unavailable bandwidth is entered with the numeric keypad, the closest available bandwidth is selected.

The zero-span case deserves some mention, because RBW is coupled to Span when in a swept (non-zero) span and in zero span there is normally no meaningful RBW coupling in Zero Span. However, when a MIL or CISPR EMC Standard is selected, there IS a meaningful coupling for RBW in Zero Span – in fact, it is coupled to Center Frequency, in order to make measurements according to the EMI specifications.

The annotation under RBW in the bottom left of the screen shows the type of filter or bandwidth that is being used. The following examples illustrate this:

–3 dB (Normal) filter BW: Res BW 300 Hz

-6 dB filter BW: Res BW (-6 dB) 422 Hz
 Noise filter BW: Res BW (Noise) 317 Hz
 Impulse filter BW: Res BW (Impulse) 444 Hz
 CISPR filter BW :Res BW (CISPR) 200 Hz
 MIL filter BW:Res BW (MIL) 1 kHz
 Flattop filter type:Res BW (Flattop) 300 Hz

Video BW

Lets you change the analyzer post-detection filter (VBW or “video bandwidth”) from 1 Hz to 8 MHz in approximately 10% steps. In addition, a wide-open video filter bandwidth may be chosen by selecting 50 MHz. The VBW is annotated at the bottom of the display, in the center.

NOTE An * is displayed next to the VBW annotation when certain detector types (Average, EMI Average, Quasi Peak, and RMS Average) are in use. This is because the VBW filter is out of the circuit for these detectors and does not affect any traces which use them. If there is any active trace using one of these detectors the * is displayed. See Normally, Video BW (Auto) selects automatic coupling of the Video BW filter to the resolution bandwidth filter using the ratio set by the VBW:3 dB RBW key. To decouple the video bandwidth, press Video BW until Man is underlined, or simply enter a new value. See [“Annotation Examples” on page 948.](#)

When the **Video BW** is manually selected, it may be returned to the coupled state by pressing the **Video BW** key until **Auto** is underlined. This may also be done by pressing Auto Couple or by performing a **Preset**.

Key Path	BW
Remote Command	[:SENSE] :BANDwidth BWIDth:VIDeo <freq> [:SENSE] :BANDwidth BWIDth:VIDeo? [:SENSE] :BANDwidth BWIDth:VIDeo:AUTO OFF ON 0 1 [:SENSE] :BANDwidth BWIDth:VIDeo:AUTO?
Example	BAND:VID 1 KHZ BAND:VID? BWID:VID:AUTO ON BWID:VID:AUTO?
Notes	For numeric entries, the analyzer chooses the nearest (arithmetically, on a linear scale, rounding up) available VBW to the value entered. The 50 MHz VBW is defined to mean “wide open”.
Notes	The values shown in this table reflect the conditions after a Mode Preset.

Dependencies	<p>Sometimes the displayed Video BW is not actually used to process the trace data:</p> <ul style="list-style-type: none"> • When the Average Detector is selected and Sweep Type is set to Swept, the video bandwidth filter cannot be used, because it uses the same hardware as the Average Detector. • When the Quasi-Peak, EMI Average or RMS Average detector is selected the VBW is implemented by the digital IF as part of the detector <p>When this is the case, the VBW still acts to change the Sweep Time, if Sweep Time is in Auto, and still affects the data on other traces for which this is not the case.</p>
Preset	3 MHz ON
State Saved	Saved in Instrument State
Min	1 Hz
Max	50 MHz
Initial S/W Revision	Prior to A.02.00
Modified at S/W Revision	A.02.00
Default Unit	Hz

Annotation Examples

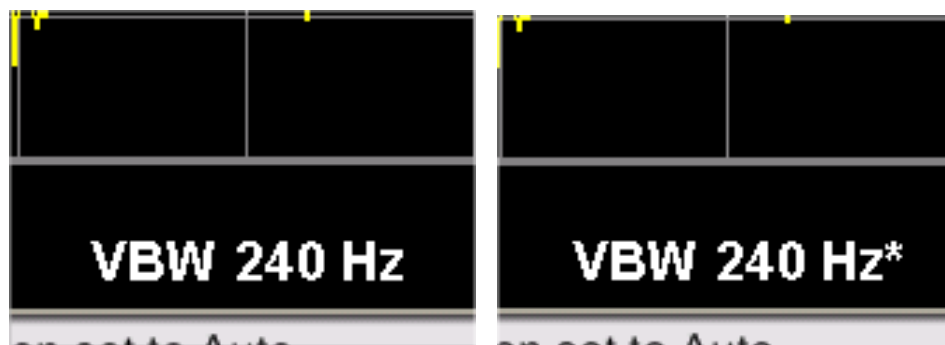

All active traces using VBW

One or more active traces not using VBW

VBW:3dB RBW

Selects the ratio between the video bandwidth and the equivalent 3 dB resolution bandwidth to be used for setting VBW when VBW is in Auto.

VBW:3dB RBW (Auto) selects automatic coupling of the VBW:3 dB RBW ratio to **Detector** using the rules described below in “Auto Rules” on page 949. To decouple the ratio, press VBW:3 dB RBW until Man is underlined, or simply enter a new value.

When the VBW:3dB RBW is manually selected, it may be returned to the coupled state by pressing the VBW:3 dB RBW key until **Auto** is underlined. This may also be done by pressing Auto Couple or by

performing a **Preset**.

Key Path	BW
Remote Command	[:SENSe]:BANDwidth BWIDth:VIDeo:RATio <real> [:SENSe]:BANDwidth BWIDth:VIDeo:RATio? [:SENSe]:BANDwidth BWIDth:VIDeo:RATio:AUTO OFF ON 0 1 [:SENSe]:BANDwidth BWIDth:VIDeo:RATio:AUTO?
Example	BAND:VID:RAT 2 BAND:VID:RAT? BAND:VID:RAT:AUTO 0 BAND:VID:RAT:AUTO?
Notes	The values shown in this table reflect the conditions after a Mode Preset.
Couplings	See “Coupling Auto Rules”
Preset	1 ON
State Saved	Saved in Instrument State
Min	0.00001
Max	3000000
Initial S/W Revision	Prior to A.02.00
Modified at S/W Revision	A.02.00

Auto Rules

The Auto Rules for the **VBW:3dB RBW** function follow.

First, if Source Mode is set to “Tracking”: Use 1.0

Otherwise, we go through the following list of detector numbers and find the lowest numbered detector being used on any active traces (traces for which Update is On):

1. Peak
2. Normal
3. Average
4. Sample
5. Negative Peak
6. EMI Average
7. Quasi Peak
8. RMS Average

BW

Use that detector to pick the ratio based on the following criteria:

1. If the detector is **Peak** and the EMC Standard is set to either CISPR or MIL, use 10.0 (we use wide VBWs to capture peak levels accurately).
2. Otherwise, if the detector is **Negative Peak**, use 1.0 (in the Negative Peak case, there are no known significant use models so we use a medium ratio).
3. Otherwise, if the detector is **Normal**, use 1.0.
4. Otherwise, if the detector is **Average**, and the span is nonzero, use 0.1. The use of a small ratio in Average detection is desirable because of its effect on the sweep time equations. The VBW filter is not actually in-circuit when the average detector is on. If the detector is Average, and the span is zero, use 10.0, which gives optimal behavior for Interval Markers in zero span.
5. Otherwise, if the detector is EMI Average, Quasi Peak or CISPR RMS, use 1.0. In fact this is a “don’t care” since no VBW is used for these detectors, as noted under “Dependencies” for the VBW key.
6. Otherwise, the detector is simply **Peak** or **Sample**. These two detectors can use the same rules. In these cases, if any active trace is in max hold or min hold, use 10.0, because Max and Min Hold operations will usually be intended to capture peaks and pits without smoothing from the VBW filter; otherwise, use 1.0 as a compromise, because you have not set the analyzer in a way that implies that you are measuring noise, pulsed-RF or CW signals, and for backward compatibility with earlier analyzers.

Note that because the above couplings depend on which traces are active, they are re-examined whenever any trace goes active or inactive, except when this leaves no traces active. Transitioning to the state where no traces are active should not affect the couplings; in that way, the annotation will always reflect the state of the last trace which was active.

Span:3dB RBW

Selects the ratio between span and resolution bandwidth.

Normally, Span:3dB RBW (Auto) selects a Span:3 dB RBW ratio of 106:1. If you manually enter the ratio, Man will become underlined, which enables you to manually select ratios more suitable for certain measurements.

When the Span:3dB RBW is manually selected, it may be returned to the coupled state by pressing the Span:3dB RBW key until **Auto** is underlined. This may also be done by pressing Auto Couple or by performing a **Preset**.

Key Path	BW
Remote Command	<pre>[:SENSe] :FREQuency:SPAN:BANDwidth[:RESolution] :RATio <integer> [:SENSe] :FREQuency:SPAN:BANDwidth[:RESolution] :RATio? [:SENSe] :FREQuency:SPAN:BANDwidth[:RESolution] :RATio:AUTO OFF ON 0 1 [:SENSe] :FREQuency:SPAN:BANDwidth[:RESolution] :RATio:AUTO?</pre>

Example	FREQ:SPAN:BAND:RAT 200 sets a ratio of 200:1, and turns off the auto coupling. FREQ:SPAN:BAND:RAT:AUTO ON FREQ:SPAN:BAND:RAT?
Notes	The values shown in this table reflect the conditions after a Mode Preset.
Dependencies	Grayed out when the EMC Standard is set to CISPR or MIL, since RBW is coupled to Center Frequency rather than Span in this case. If the grayed out key is pressed, an advisory message is generated. If the equivalent SCPI command is sent, the command is acted upon, but it doesn't affect the current measurement.
Preset	106 ON
State Saved	Saved in Instrument State
Min	2
Max	10000
Initial S/W Revision	Prior to A.02.00

RBW Control

Selects the type/shape for the resolution bandwidth filters. Historically, the Res BW filters in Agilent spectrum analyzers were Gaussian filters, specified using the –3 dB bandwidth of the filter. That is, a 10 MHz Res BW filter was a Gaussian shape with its –3 dB points 10 MHz apart. In the X-Series you can, using the **Filter BW** key, specify bandwidths other than the –3 dB bandwidth (–6 dB, Noise, Impulse) for the width of the Gaussian filters. Furthermore, the **Filter BW** menu lets you choose between a Gaussian and Flat Top filter shape, for varying measurement conditions.

Key Path	BW
Dependencies]The RBW Control key is grayed out if the EMC Standard is set to CISPR or MIL . In this case the Filter Type is always Gaussian; the Filter BW is chosen as appropriate for the filter and the standard.
Readback line	[<filter type>] or, if Filter Type is Gaussian, [Gaussian,<filter BW>]
Initial S/W Revision	Prior to A.02.00
Modified at S/W Revision	A.02.00

Filter Type

Besides the familiar Gaussian filter shape, there are certain special filter types, such as Flat Top, that are desirable under certain conditions. The **Filter Type** menu gives you control over these types.

BW

See “More Information” on page 952

Key Path	BW, RBW Control
Remote Command	[:SENSe] :BANDwidth BWIDth :SHAPE GAUSSian FLATtop [:SENSe] :BANDwidth BWIDth :SHAPE?
Example	BAND:SHAP GAUS
Notes	GAUSSian= Gaussian FLATtop = Flattop
Dependencies	When EMC Standard is set to CISPR or MIL , the Filter Type is always Gaussian
Preset	Auto Couple chooses the preset value
State Saved	Saved in State
Readback line	1-of-N selection
Initial S/W Revision	Prior to A.02.00
Modified at S/W Revision	A.02.00

More Information

Gaussian filters

When the Gaussian filter type is chosen, a set of 160 RBW filters are available whose shape is approximately Gaussian. The actual bandwidths used to realize the X-Series’s Gaussian filters are chosen to come as close as possible to a 24 step per decade series, within the limitations of the digital IF.

For Gaussian filters, the annotation at the bottom of the screen shows the filter bandwidth type (unless it is Normal). This will be shown parenthetically between the words “Res BW” and the value, for example

Res BW 10.0 Hz (Normal bandwidth)

Res BW (Impulse) 14.8 Hz (Impulse bandwidth)

Flattop filters

When the Flattop filter type is chosen, a new set of 134 RBW hardware settings are available. These settings realize filters that are approximately rectangular in shape. When this shape is chosen the filter bandwidth options are irrelevant and therefore unavailable.

The annotation at the bottom of the screen will show that the Flattop shape is being used, for example:

Res BW (Flattop) 10 Hz

Gaussian

Selects the Gaussian filter type. There are 160 of these RBWs. They are arranged in a 24-per-decade sequence from 1 Hz through 3 MHz, plus the 4, 5, 6 and 8 MHz settings.

Key Path	BW, RBW Control, Filter Type
----------	-------------------------------------

Example	BAND:SHAP GAUS
Notes	Parameter is GAUSSian. See remote command in section “Filter Type ” on page 951 .
Readback	Gaussian
Initial S/W Revision	Prior to A.02.00

Flattop

Selects the flat top filter type

Key Path	BW, RBW Control, Filter Type
Example	BAND:SHAP FLAT
Readback	Flattop
Initial S/W Revision	Prior to A.02.00

Filter BW

When using the Gaussian filters for certain types of applications it can be useful to be able to specify the filter width using points other than the –3 dB points. The Filter BW function allows you to pick the filter based on its –3 dB (Normal) bandwidth, its –6 dB bandwidth, its Noise bandwidth, or its Impulse bandwidth. Note that in all four cases the –3 dB bandwidth is the same. The filter does not change, but the way you specify it changes.

See “[More Information](#)” on [page 954](#)

Key Path	BW, RBW Control
Remote Command	[:SENSe] :BANDwidth BWIDth :TYPE DB3 DB6 IMPulse NOISe [:SENSe] :BANDwidth BWIDth :TYPE?
Example	BAND:TYPE NOIS
Notes	DB3 = –3 dB (Normal) DB6 = –6 dB IMPulse = Impulse NOISe = Noise
Dependencies	Grayed out if the Flattop filter type is selected. When EMC Standard is set to CISPR or MIL , the Filter BW is chosen as appropriate for the filter and the standard.
Preset	Auto Couple chooses the preset value
State Saved	Saved in State
Readback line	1-of-N selection
Initial S/W Revision	Prior to A.02.00

Modified at S/W Revision	A.02.00
--------------------------	---------

More Information

The analyzer provides four ways of specifying the bandwidth of a Gaussian filter:

1. The -3 dB bandwidth of the filter
2. The -6 dB bandwidth of the filter
3. The equivalent Noise bandwidth of the filter, which is defined as the bandwidth of a rectangular filter with the same peak gain which would pass the same power for noise signals.
4. The equivalent Impulse bandwidth of the filter, which is defined as the bandwidth of a rectangular filter with the same peak gain which would pass the same power for impulsive (narrow pulsed) signals.

The figure below shows the relationships of the various filter bandwidths for filters with the X-Series' shape factor (shape factor is defined as the ratio of the -60 dB bandwidth to the - 3 dB bandwidth):

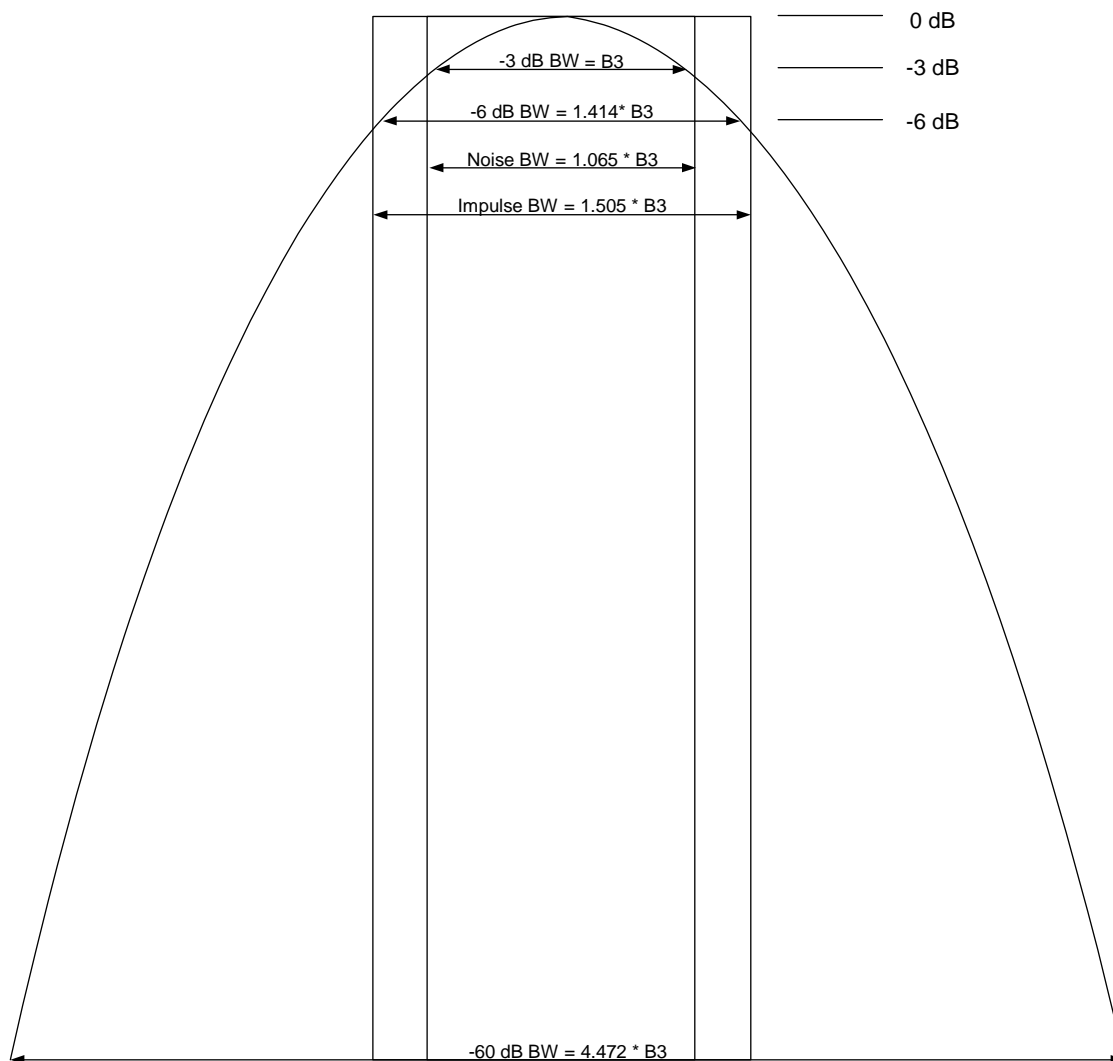

The Filter Type menu lets you choose the filter bandwidth (–3 dB, –6 dB, Noise or Impulse) that will be used when specifying the width of the filter. Note that for a given Gaussian filter, changing the filter bandwidth specification does not affect the filter width at all but only the means of specifying it. For example, the filter whose –3 dB bandwidth is 1.0 kHz is the same as the filter whose –6 dB bandwidth is 1.41 kHz, whose Noise bandwidth is 1.06 kHz, and whose Impulse bandwidth is 1.48 kHz. As you cycle through these various filter bandwidths the filter does not change, but the way the filter is annotated and the value which appears in the active function area and on the softkey does.

–3 dB (Normal)

Selects the normal gaussian-shaped bandwidths that are defined by their –3 dB bandwidths.

Key Path	BW, RBW Control, Filter BW
Example	BAND:TYPE DB3
Readback	–3 dB
Initial S/W Revision	Prior to A.02.00

–6 dB

Selects the filter bandwidths where the bandwidth is defined at the –6 dB points. This uses the normal RBW filters, but the value displayed on the key, active function line and screen annotation changes to reflect the –6 dB bandwidth instead of the –3 dB bandwidth.

Key Path	BW, RBW Control, Filter BW
Example	BAND:TYPE DB6
Readback	–6 dB
Initial S/W Revision	Prior to A.02.00

Noise

Selects the noise filter bandwidths. This uses the normal RBW filters, but the value displayed on the key, active function line and screen annotation changes to reflect the equivalent noise bandwidth, instead of the –3 dB bandwidth.

Key Path	BW, RBW Control, Filter BW
Example	BAND:TYPE NOIS
Readback	Noise
Initial S/W Revision	Prior to A.02.00

Impulse

Selects the impulse bandwidths. This uses the normal RBW filters, but the value displayed on the key, active function line and screen annotation changes to reflect the equivalent impulse bandwidth instead of

BW

the -3 dB bandwidth.

Key Path	BW, RBW Control, Filter BW
Example	BAND:TYPE IMP
Readback	Impulse
Initial S/W Revision	Prior to A.02.00

Cont (Continuous Measurement/Sweep)

Sets the analyzer for Continuous measurement operation. The single/continuous state is Meas Global so the setting will affect all measurements. If you are Paused, pressing **Cont** does a Resume.

Key Path	Front-panel key
Remote Command	:INITiate:CONTinuous OFF ON 0 1 :INITiate:CONTinuous?
Example	:INIT:CONT 0 puts analyzer in Single measurement operation. :INIT:CONT 1 puts analyzer in Continuous measurement operation
Preset	ON (Note that SYST:PRESet sets INIT:CONT to ON but *RST sets INIT:CONT to OFF)
State Saved	Saved in instrument state
Initial S/W Revision	Prior to A.02.00

In Swept SA Measurement (Spectrum Analysis Mode):

The analyzer takes repetitive sweeps, averages, measurements, etc., when in Continuous mode. When the average count reaches the Average/Hold Number the count stops incrementing, but the analyzer keeps sweeping. See the Trace/Detector section for the averaging formula used both before and after the Average/Hold Number is reached. The trigger condition must be met prior to each sweep. The type of trace processing for multiple sweeps, is set under the Trace/Detector key, with choices of **Trace Average**, **Max Hold**, or **Min Hold**.

In Other Measurements/Modes:

With **Avg/Hold Num** (in the **Meas Setup** menu) set to **Off** or set to **On** with a value of 1, a sweep is taken after the trigger condition is met; and the analyzer continues to take new sweeps after the current sweep has completed and the trigger condition is again met. However, with **Avg/Hold Num** set to **On** with a value >1, multiple sweeps (data acquisitions) are taken for the measurement. The trigger condition must be met prior to each sweep. The sweep is not stopped when the average count k equals the number N set for Avg/Hold Num is reached, but the number k stops incrementing. A measurement average usually applies to all traces, marker results, and numeric results. But sometimes it only applies to the numeric results.

If the analyzer is in Single measurement, pressing the **Cont** key does not change k and does not cause the sweep to be reset; the only action is to put the analyzer into Continuous measurement operation.

If it is already in continuous sweep:

- the INIT:CONT 1 command has no effect
- the INIT:CONT 0 command will place the analyzer in Single Sweep but will have no effect on the current sequence until k = N, at which point the current sequence will stop and the instrument will go to the idle state.

Cont (Continuous Measurement/Sweep)

FREQ Channel

Accesses a menu allowing you to set Frequency parameters for the current measurement. All measurements in CMMB mode have the same menu structure.

Key Path	Front-panel key
Initial S/W Revision	A.03.00

Channel

Sets the analyzer to a frequency that corresponds to the Channel Number. If the Center Freq value entered does not exactly correlate with the Channel, the displaying value will be '---'. Refer to [“Appendix A: Channel Identification Plans” on page 1323](#) for more details about the channel identification plans.

Key Path	FREQ Channel
Mode	CMMB
Remote Command	[:SENSE] :FREQuency:CHANnel:NUMBer <integer> [:SENSE] :FREQuency:CHANnel:NUMBer?
Example	FREQ:CHAN:NUMB 21 FREQ:CHAN:NUMB?
Dependencies	If the analyzer has multiple inputs and the selected input is BBIQ, this key will be grayed out and the displaying value will be '---'.
Couplings	Channel is coupled with Center Freq. A certain Channel corresponds to a certain value of Center Freq. If the Center Freq value entered does not exactly correlate with a Channel, the displaying value will be '---', and the returned value of the SCPI command 'FREQ:CHAN:NUMB?' is '-999'.
Preset	28
State Saved	Saved in instrument state.
Min	Depends on the selected channel table.
Max	Depends on the selected channel table.
Initial S/W Revision	A.03.00

Center Freq

Sets the center frequency. If the analyzer has multiple inputs (RF and IQ), the displayed value will be updated according to the selected input. SCPI commands are available to directly set the center frequency for a specific input. This key is coupled with Channel when the selected input is RF.

FREQ Channel

See also:

[“RF Center Freq” on page 961](#)

[“IQ Center Freq” on page 961](#)

Key Path	FREQ Channel
Mode	CMMB
Remote Command	[:SENSe] :FREQuency:CENTer <freq> [:SENSe] :FREQuency:CENTer?
Example	FREQ:CENT 1.0MHZ FREQ:CENT?
Couplings	Center Freq is coupled with Channel. A certain value of center frequency corresponds to a certain Channel. If the Channel changes, the Center Frequency will be changed to the frequency which is the center of the channel.
Preset	634.000000 MHz
State Saved	Saved in instrument state.
Min	-79.999995 MHz
Max	Hardware Dependent, for details, see “Maximum Frequency in X - Series Signal Analyzer” on page 960 .
Initial S/W Revision	A.03.00

Maximum Frequency in X - Series Signal Analyzer

The following table lists the maximum frequency in different X - Series signal analyzers.

Model numbers: N9020A, N9030A

Freq Option	Stop Freq after Mode Preset	Max Freq (can't tune above)
503	3.6 GHz	3.7 GHz
508	8.4 GHz	8.5 GHz
513	13.6 GHz	13.8 GHz
526	26.5 GHz	27.0 GHz

Model numbers: N9010A

Freq Option	Stop Freq after Mode Preset	Max Freq (can't tune above)
503	3.6 GHz	3.7 GHz

Freq Option	Stop Freq after Mode Preset	Max Freq (can't tune above)
507	7.0 GHz	7.1 GHz
513	13.6 GHz	13.8 GHz
526	26.5 GHz	27.0 GHz

Model numbers: N9000A

Freq Option	Stop Freq after Mode Preset	Max Freq (can't tune above)
503	3.0 GHz	3.08 GHz
507	7.5 GHz	7.58 GHz

RF Center Freq

SCPI command to specify the RF Center Frequency. This will always access the RF value, even when the selected input is not RF.

Key Path	FREQ Channel
Mode	CMMB
Remote Command	[:SENSE] :FREQuency:RF:CENTer <freq> [:SENSe] :FREQuency:RF:CENTer?
Example	FREQ:RF:CENt 1.0MHZ FREQ:RF:CENt?
Couplings	Center Freq is coupled with Channel. A certain value of center frequency corresponds to a certain Channel. If the Channel changes, the Center Frequency will be changed to the frequency which is the center of the channel.
Preset	634.000000 MHz
State Saved	Saved in instrument state.
Min	-79.999995 MHz
Max	Hardware Dependent, for details, see “Maximum Frequency in X - Series Signal Analyzer” on page 960.
Initial S/W Revision	A.03.00

IQ Center Freq

SCPI command to specify the I/Q Center Frequency. This will always access the I/Q value, even when

FREQ Channel

the selected input is not I/Q.

Key Path	FREQ Channel
Mode	CMMB
Remote Command	[:SENSE] :FREQuency:IQ:CENTer <freq> [:SENSE] :FREQuency:IQ:CENTer?
Example	FREQ:IQ:CENT 1.0MHZ FREQ:IQ:CENT?
Preset	0 Hz
State Saved	Saved in instrument state.
Min	-39.999995 MHz
Max	39.999995 MHz
Initial S/W Revision	A.03.00

Chan Step

Sets the step size for the Channel Number.

Key Path	FREQ Channel
Mode	CMMB
Remote Command	[:SENSE] :FREQuency:CHANnel:STEP <integer> [:SENSE] :FREQuency:CHANnel:STEP?
Example	FREQ:CHAN:STEP 1 FREQ:CHAN:STEP?
Dependencies	If the analyzer has multiple inputs and the selected input is BBIQ, this key will be grayed out.
Preset	1
State Saved	Saved in instrument state.
Min	1
Max	Depends on the selected channel table.
Initial S/W Revision	A.03.00

CF Step

Sets the step size for center frequency. If CF Step State is manual, you can set this value manually.

Key Path	FREQ Channel
----------	---------------------

Mode	CMMB
Remote Command	[:SENSE] :FREQuency:CENTer:STEP [:INCRe ment] <freq> [:SENSe] :FREQuency:CENTer:STEP [:INCRe ment] ? [:SENSe] :FREQuency:CENTer:STEP:AUTO ON OFF 1 0 [:SENSe] :FREQuency:CENTer:STEP:AUTO?
Example	FREQ:CENT:STEP 100KHZ FREQ:CENT:STEP? FREQ:CENT:STEP:AUTO OFF FREQ:CENT:STEP:AUTO?
Preset	8.00 MHz ON
State Saved	Saved in instrument state.
Min	1.0 kHz
Max	1 GHz
Initial S/W Revision	A.03.00

Channel Table

Allows you to choose the appropriate TV standard: NTSC-M, NTSC-J, NTSC-Brazil, PAL-M, PAL-B/G, PAL-D/K, or PAL-I. Refer to “[Appendix A: Channel Identification Plans](#)” on page 1323 for more details about the channel identification plans.

Key Path	FREQ Channel
Mode	CMMB
Remote Command	[:SENSE] :FREQuency:CHANnel:TABLE [:SELEct] MNTSc JNTSc BNTSc MPAL IPAL BPAL DPAL [:SENSe] :FREQuency:CHANnel:TABLE [:SELEct] ?
Example	FREQ:CHAN:TABL DPAL FREQ:CHAN:TABL?
Couplings	Couple with Channel. Setting Chan Table sets the range of Channel to the value corresponding to that Chan Table.
Preset	DPAL
State Saved	Saved in instrument state.
Range	NTSC-M NTSC-J NTSC-Brazil PAL-M PAL-I PAL-B/G PAL-D/K
Initial S/W Revision	A.03.00

FREQ Channel

NTSC-M

If the current TV standard is NTSC-M, you can choose the appropriate channel plans in NTSC-M standard: Standard Cable (STD), Broadcast Channel (AIR), HRC Cable (HRC) or IRC Cable (IRC). Refer to “[NTSC-M](#)” on page 1325 for more details about the channel identification plans.

Key Path	FREQ Channel, Chan Table
Mode	CMMB
Remote Command	[:SENSE] :FREQUency:CHANnel:TABLE:MNTSc [:SElect] STD AIR HRC IRC [:SENSE] :FREQUency:CHANnel:TABLE:MNTSc [:SElect] ?
Example	FREQ:CHAN:TABL:MNTS STD FREQ:CHAN:TABL:MNTS?
Preset	STD
State Saved	Saved in instrument state.
Range	STD AIR HRC IRC
Initial S/W Revision	A.03.00

NTSC-J

If the current TV standard is NTSC-J, you can choose the appropriate channel plans in NTSC-J standard: Japan Standard Cable (Cable) or Japan Broadcast channels (AIR). Refer to “[NTSC-J](#)” on page 1334 for more details about the channel identification plans.

Key Path	FREQ Channel, Chan Table
Mode	CMMB
Remote Command	[:SENSE] :FREQUency:CHANnel:TABLE:JNTSc [:SElect] CBL AIR [:SENSE] :FREQUency:CHANnel:TABLE:JNTSc [:SElect] ?
Example	FREQ:CHAN:TABL:JNTS AIR FREQ:CHAN:TABL:JNTS?
Preset	AIR
State Saved	Saved in instrument state.
Range	Cable AIR
Initial S/W Revision	A.03.00

NTSC-Brazil

If the current TV standard is NTSC-Brazil, you can choose the appropriate channel plans in NTSC-Brazil standard: NTSC-Brazil VHF or NTSC-Brazil UHF. Refer to “[NTSC-Brazil](#)” on page 1340

for more details about the channel identification plans.

Key Path	FREQ Channel, Chan Table
Mode	CMMB
Remote Command	[:SENSE] :FREQuency :CHANnel :TABLe :BNTSc [:SElect] VHF UHF [:SENSE] :FREQuency :CHANnel :TABLe :BNTSc [:SElect] ?
Example	FREQ:CHAN:TABL:BNTS VHF FREQ:CHAN:TABL:BNTS?
Preset	UHF
State Saved	Saved in instrument state.
Range	VHF UHF
Initial S/W Revision	A.06.00

PAL-M

If the current TV standard is PAL-M, you can choose the appropriate channel plans in PAL-M standard: Standard Cable (STD), Broadcast Channel (AIR), HRC Cable (HRC) or IRC Cable (IRC). Refer to [“PAL-M” on page 1343](#) for more details about the channel identification plans.

Key Path	FREQ Channel, Chan Table
Mode	CMMB
Remote Command	[:SENSE] :FREQuency :CHANnel :TABLe :MPAL [:SElect] STD AIR HRC IRC [:SENSE] :FREQuency :CHANnel :TABLe :MPAL [:SElect] ?
Example	FREQ:CHAN:TABL:MPAL STD FREQ:CHAN:TABL:MPAL?
Preset	STD
State Saved	Saved in instrument state.
Range	STD AIR HRC IRC
Initial S/W Revision	A.03.00

PAL-I

If the current TV standard is PAL-I, you can choose the appropriate channel plans in PAL-I standard: HRC Cable (HRC), VHF channels (VHF) or UHF channels (UHF). Refer to [“PAL-I” on page 1343](#) for more details about the channel identification plans.

Key Path	FREQ Channel, Chan Table
Mode	CMMB

FREQ Channel

Remote Command	[:SENSe] :FREQuency:CHANnel:TABLE:IPAL[:SElect] VHF UHF HRC [:SENSe] :FREQuency:CHANnel:TABLE:IPAL[:SElect]?
Example	FREQ:CHAN:TABL:IPAL HRC FREQ:CHAN:TABL:IPAL?
Preset	HRC
State Saved	Saved in instrument state.
Range	VHF UHF HRC
Initial S/W Revision	A.03.00

PAL-B/G

If the current TV standard is PAL-B/G, you can choose the appropriate channel plans in PAL-B/G standard: HRC Cable (HRC), VHF channels (VHF), UHF channels (UHF), S channels PAL-B/G Standard (S), S channels PAL-B/G Cable (S-Cable) or CENELEC channels (CENELEC). Refer to [“PAL-B/G” on page 1344](#) for more details about the channel identification plans.

Key Path	FREQ Channel, Chan Table
Mode	CMMB
Remote Command	[:SENSe] :FREQuency:CHANnel:TABLE:BPAL[:SElect] VHF UHF HRC S SCBL CEN [:SENSe] :FREQuency:CHANnel:TABLE:BPAL[:SElect]?
Example	FREQ:CHAN:TABL:BPAL HRC FREQ:CHAN:TABL:BPAL?
Preset	HRC
State Saved	Saved in instrument state.
Range	VHF UHF HRC S S-Cable CENELEC
Initial S/W Revision	A.03.00

PAL-D/K

If the current TV standard is PAL-D/K, you can choose the appropriate channel plans in PAL-D/K standard: China Broadcast Channels (DS) or China Standard Cable (Z). Refer to [“PAL-D/K \(8 MHz\)” on page 1359](#) for more details about the channel identification plans.

Key Path	FREQ Channel, Chan Table
Mode	CMMB
Remote Command	[:SENSe] :FREQuency:CHANnel:TABLE:DPAL[:SElect] DS Z [:SENSe] :FREQuency:CHANnel:TABLE:DPAL[:SElect]?

Example	FREQ:CHAN:TABL:DPAL DS FREQ:CHAN:TABL:DPAL?
Preset	DS
State Saved	Saved in instrument state.
Range	DS Z
Initial S/W Revision	A.03.00

Input/Output

The Input/Output features are common across multiple Modes and Measurements. These common features are described in this section. See the Measurement description for information on features that are unique.

The Input/Output key accesses the softkeys that control the Input/Output parameters of the instrument. In general, these are functions associated with external connections to the analyzer, either to the inputs or the outputs. Since these connections tend to be fairly stable within a given setup, in general the input/output settings do not change when you Preset the analyzer.

Other functions related to the input/output connections, but which tend to change on a measurement by measurement basis, can be found under the **Trigger** and **AMPTD Y Scale** keys. In addition, some of the digital I/O bus configurations can be found under the **System** key.

NOTE The functions in the Input/Output menu are "global" (common) to all Modes (applications). But individual Input/Output functions only appear in a Mode if they apply to that Mode. Functions that apply to a Mode but not to all measurements in the Mode may be grayed-out in some measurements.

[“Input/Output variables - Preset behavior” on page 969](#)

The Input Port selection is the first menu under the **Input/Output** key:

Key Path	Front-panel key
Remote Command	[:SENSe] :FEED RF AIQ IQ IONLy QONLy INDependent AREFERENCE [:SENSe] :FEED?
Preset	This setting is unaffected by a Preset or power cycle. It survives a Mode Preset and mode changes. It is set to RF on a "Restore Input/Output Defaults" or "Restore System Defaults->All"
State Saved	Saved in instrument state
Backwards Compatibility SCPI	The legacy parameter [:SENSe]:FEED AREFERENCE is aliased to the new command [:SENSe]:FEED:AREF REF50 for backwards compatibility. This causes the input to be switched to the 50 MHz calibrator.
Initial S/W Revision	Prior to A.02.00

Input/Output variables - Preset behavior

Virtually all the input/output settings are NOT a part of mode preset. They can be set to their default value by one of the three ways - by using the Restore Input/Output Defaults key on the first page of the input/output menu, by using the System->Restore System Defaults->Input/Output Settings or by using the System -> Restore System Defaults->All. Also, they survive a Preset and a Power cycle.

Input/Output

A very few of the Input/Output settings do respond to a Mode Preset; for example, if the Calibrator is on it turns off on a Preset, and if DC coupling is in effect it switches to AC on a Preset. These exceptions are made in the interest of reliability and usability, which overrides the need for absolute consistency. Exceptions are noted in the SCPI table for the excepted functions.

RF Input

Selects the front-panel RF input port to be the analyzer signal input. If RF is already selected, pressing this key accesses the RF input setup functions.

Key Path	Input/Output
Example	[[:SENSE]:FEED RF
Readback	The current input impedance settings are Readback to this key i.e. "XX, ZZ" where XX is AC or DC and ZZ is 50 or 75
Initial S/W Revision	Prior to A.02.00

Input Z Correction

Sets the input impedance for unit conversions. This affects the results when the y-axis unit is voltage or current units (dBmV, dB μ V, dB μ A, V, A), but not when it is power units (dBm, W). The impedance you select is for computational purposes only, since the actual impedance is set by internal hardware to 50 ohms. Setting the computational input impedance to 75 ohms is useful when using a 75 ohm to 50 ohm adapter to measure a 75 ohm device on an analyzer with a 50 ohm input impedance.

There are a variety ways to make 50 to 75 ohm transitions, such as impedance transformers or minimum loss pads. The choice of the solution that is best for your measurement situation requires balancing the amount of loss that you can tolerate with the amount of measurement frequency range that you need. If you are using one of these pads/adaptors with the **Input Z Corr** function, you might also want to use the **Ext Gain** key. This function is used to set a correction value to compensate for the gain (loss) through your pad. This correction factor is applied to the displayed measurement values.

Key Path	Input/Output, RF Input
Remote Command	[[:SENSE]:CORREction:IMPedance[:INPut][:MAGNitude] 50 75 [:SENSE]:CORREction:IMPedance[:INPut][:MAGNitude]?
Example	CORR:IMP 75 sets the input impedance correction to 75 ohms. CORR:IMP?
Preset	This is unaffected by a Preset but is set to 50 ohms on a "Restore Input/Output Defaults" or "Restore System Defaults->All" Some instruments/options may have 75 ohms available.
State Saved	Saved in instrument state
Readback	50 Ω or 75 Ω Current setting reads back to the RF key.
Initial S/W Revision	Prior to A.02.00

RF Coupling

Specifies alternating current (AC) or direct current (DC) coupling at the analyzer RF input port. Selecting AC coupling switches in a blocking capacitor that blocks any DC voltage present at the analyzer input. This decreases the input frequency range of the analyzer, but prevents damage to the input circuitry of the analyzer if there is a DC voltage present at the RF input.

In AC coupling mode, you can view signals below the corner frequency of the DC block, but below a certain frequency the amplitude accuracy is not specified. The frequency below which specifications do not apply is:

X-Series Model	Lowest Freq for meeting specs when AC coupled	Lowest Freq for meeting specs when DC coupled
N9000A	100 kHz	n/a
N9010A	10 MHz	9 kHz
N9020A	10 MHz	3 Hz
N9030A	10 MHz	3 Hz

Some amplitude specifications apply only when coupling is set to DC. Refer to the appropriate amplitude specifications and characteristics for your analyzer.

When operating in DC coupled mode, ensure protection of the analyzer input circuitry by limiting the DC part of the input level to within 200 mV of 0 Vdc. In AC or DC coupling, limit the input RF power to +30 dBm (1 Watt).

Key Path	Input/Output, RF Input
Remote Command	:INPut:COUPling AC DC :INPut:COUPling?
Example	INP:COUP DC
Dependencies	This key does not appear in models that are always AC coupled. When the SCPI command to set DC coupling is sent to these models, it results in the error “Illegal parameter value;This model is always AC coupled” In these models, the SCPI query INP:COUP? always returns AC.
Preset	AC
State Saved	Saved in instrument state.
Initial S/W Revision	Prior to A.02.00
Modified at S/W Revision	A.03.00

I/Q

This feature is not available unless the “[Baseband I/Q \(Option BBA\)](#)” on page 972 is installed.

Selects the front-panel I/Q input ports to be the analyzer signal input. If I/Q is already selected, pressing

Input/Output

this key accesses the I/Q setup menu.

Key Path	Input/Output
Mode	BASIC, CDMA2K, EDGE/GSM, TDSCDMA, VSA89601, WIMAX/OFDMA
Example	FEED AIQ
Notes	Not all measurements support the use of the I/Q signal input. When I/Q is selected in a measurement that does not support it, the "Meas invalid with I/Q inputs" error condition occurs.
Notes	<p>The parameters IQ IONLy QONLy are only supported for backwards compatibility. The E44406 SCPI has the following that corresponds to FEED:IQ:TYPE for X-Series.</p> <pre>[[:SENSe]:FEED IQ IONLy QONLy [:SENSe]:FEED?</pre> <p>[[:SENSe]:FEED IQ will set the I/Q path to IQ [:SENSe]:FEED IONLy will set the I/Q path to I Only [:SENSe]:FEED QONLy will set the I/Q path to QOnly</p> <hr/> <p>NOTE [:SENSe]:FEED? will not be backward compatible. The query [:SENSe]:FEED? will always returns AIQ whatever the type of legacy parameters IQ IONLy QONLy has been used.</p> <hr/>
Initial S/W Revision	Prior to A.02.00

Baseband I/Q (Option BBA)

The Baseband I/Q functionality is a hardware option. It is option BBA. If the option is not installed, none of the I/Q functionality is enabled.

The Baseband I/Q has four input ports and one output port. The input ports are I, I-bar, Q, and Q-bar. The I and I-bar together compose the I channel and the Q and Q-bar together compose the Q channel. Each channel has two modes of operation, Single-Ended (also called "unbalanced") and Differential Input (also called "balanced"). When in Single-Ended operation, only the main port (I or Q) is used and the complementary port (I-bar or Q-bar) is ignored. When in Differential Input mode, both main and complementary ports are used.

The input settings (range, attenuation, skew, impedance, external gain) apply to the channels, not the individual ports.

The system supports a variety of 1 M Ω input passive probes as well as the Agilent 113x Series active differential probes using the Infinimax probe interface.

The Agilent 113x Series active probes can be used for both single ended and differential measurements. In either case a single connection is made for each channel (on either the I or Q input). The input is automatically configured to 50 Ω single ended and the probe power is supplied through the Infinimax interface. The probe can be configured for a variety of input coupling and low frequency rejection

modes. In addition, a wide range of offset voltages and probe attenuation accessories are supported at the probe interface. The active probe has the advantage that it does not significantly load the circuit under test, even with unity gain probing.

With passive 1 M Ω probes, the probe will introduce a capacitive load on the circuit, unless higher attenuation is used at the probe interface. Higher attenuation reduces the signal level and degrades the signal-to-noise-ratio of the measurement. Passive probes are available with a variety of attenuation values for a moderate cost. Most Agilent passive probes can be automatically identified by the system, setting the input impedance setting required as well as the nominal attenuation. For single ended measurements a single probe is used for each channel. Other passive probes can be used, with the attenuation and impedance settings configured manually.

For full differential measurements, the system supports probes on each of the four inputs. The attenuation of the probes should be the same for good common mode rejection and channel match.

Both active and passive probes in single ended and differential configurations can be calibrated. This calibration uses the Cal Out BNC connection and a probe connection accessory. The calibration achieves excellent absolute gain flatness in a probed measurement. It matches both the gain and frequency response of the I and Q channels as well as any delay skew, resulting in high accuracy in derived measurements such as Error Vector Magnitude (EVM).

When a probe is connected a status message will be displayed. The message will indicate if calibration data is available or not. Calibration data is saved for each type of probe (including "none") for each port and will be reapplied whenever that type of probe is re-connected to the same port. For probes with EEPROM identification, the calibration data will be stored based on the unique probe identifier and will reapply data for that particular probe if it is available. The data will not follow a probe from one port to another. For probes without EEPROM identification, the instrument cannot distinguish between different probes of the same type and it will use the data from the last calibration for that probe type on that port.

When in differential mode, both the main and complementary probes are expected to be of the same type.

In some situations, the I and Q channels should be configured identically. In other situations it is convenient to control them independently. Some menus have a "Q Same as I" setting that will cause the Q channel configuration to mirror the I channel configuration, avoiding the overhead of double data entry when the channels should be the same.

The output port is for calibrating the I/Q input ports, although it can also be manually controlled.

There are two types of calibrations available: cable calibration and probe calibration. The cable calibration will guide the user through connecting each input port in turn. All ports must be calibrated together. The probe calibration is done for a specific channel (I or Q). If in Single-Ended mode, only the main port is calibrated. When in Differential Input mode, the user is guided through calibrating both main and complementary ports.

The front panel I/Q port LEDs indicate the current state of that port. On (green) indicates it is active, and off (dark) indicates it is not in use. For example, the Cal Out port LED is on if and only if there is signal coming out of that port.

The input is a context and some parameters have separate values for each context. The SCPI for these parameters has an optional "[:RF|IQ]" node. If the specific context is omitted, the command acts on the current input context's value. Here are the parameters that are input context sensitive:

- Center Frequency

Input/Output

- Trigger Source

It is important to distinguish between the I and Q input ports and the displayed I and Q data values. The I and Q input ports feed into a digital receiver that does digital tuning and filtering. The I and Q data seen by the user (either on the display or through SCPI) corresponds to the real ("I") and the imaginary ("Q") output from the digital receiver. When the input path is I+jQ or I Only and the center frequency is 0 Hz the I input ends up in as the real output from the receiver and appears as "I" data. Likewise, when the input path is I+jQ and the center frequency is 0 Hz, the Q input ends up as the imaginary output from the receiver and appears as "Q" data. However, when the input path is Q Only, the Q input is sent to the receiver as Q+j0, so the receiver output has the Q input coming out on the real output, and so in Q Only, the signal from the Q input port appears as the "I" data. Another situation where the I and Q data do not necessarily correspond directly to the I and Q inputs is when the center frequency is non-zero. The digital processing involved in the tuning is a complex operation. This will result in I Only data appearing as both "I" and "Q" data, the same as that signal would appear if seen through the RF input port.

I/Q Path

Selects which I/Q input channels are active. The LED next to each I/Q input port will be on when that port is active.

The analysis bandwidth for each channel is the same as that of the instrument. So, for example, the base N9020A has a bandwidth of 10 MHz. With I/Q input the I and Q channels would each have an analysis bandwidth of 10 MHz, giving 20 MHz of bandwidth when the I/Q Path is I+jQ. With option B25, the available bandwidth becomes 25 MHz, giving 25 MHz each to I and Q and 50 MHz to I+jQ.

I/Q voltage to power conversion processing is dependent on the I/Q Path selected.

- With I+jQ input we know that the input signal may not be symmetrical about 0 Hz, because it has a complex component. Therefore, above 0 Hz only the positive frequency information is displayed, and below 0 Hz only the negative frequency information is displayed.
- With all other Input Path selections, the input signal has no complex component and therefore is always symmetrical about 0 Hz. In this case, by convention, the power conversion shows the combined voltage for both the positive and negative frequencies. The information displayed below 0 Hz is the mirror of the information displayed above 0 Hz. This results in a power reading 6.02 dB higher (for both) than would be seen with only the positive frequency voltage. Note also that, in this case the real signal may have complex modulation embedded in it, but that must be recovered by further signal processing.

Key Path	Input/Output, I/Q
Remote Command	[:SENSE] :FEED:IQ:TYPE IQ IONLY QONLY INDEPENDENT [:SENSE] :FEED:IQ:TYPE?
Example	Set the input to be both the I and Q channels, combined as I + j * Q. FEED:IQ:TYPE IQ
Notes	The Independent I and Q selection is only available in GPVSA
Preset	IQ

State Saved	Yes This is unaffected by a Preset but is set to the default value on a "Restore Input/Output Defaults" or "Restore System Defaults->All"
Range	I+jQ I Only Q Only Independent I and Q
Readback Text	I+jQ I Only Q Only Ind I/Q
Initial S/W Revision	Prior to A.02.00

Remote Command	: INPut [1] : IQ:TYPE IQ I Q : INPut [1] : IQ:TYPE?
Preset	IQ
Initial S/W Revision	Prior to A.02.00

I+jQ

Sets the signal input to be both the I and Q channels. The I and Q channel data will be combined as $I + j * Q$.

Key Path	Input/Output, I/Q, I/Q Path
Example	Set the input to be both the I and Q channels, combined as $I + j * Q$. FEED:IQ:TYPE IQ
Initial S/W Revision	Prior to A.02.00

I Only

Sets the signal input to be only the I channel. The Q channel will be ignored. The data collected is still complex. When the center frequency is 0 the imaginary part will always be zero, but for any other center frequency both the real and imaginary parts will be significant.

Key Path	Input/Output, I/Q, I/Q Path
Example	Set the input to be only the I channel. FEED:IQ:TYPE IONL
Initial S/W Revision	Prior to A.02.00

Q Only

Sets the signal input to be only the Q channel. The I channel will be ignored. The Q channel will be sent to the digital receiver block as $Q+j0$. The receiver's output is still complex. When the center frequency is 0 the imaginary part will always be zero, but for any other center frequency both the real and imaginary parts will be significant. Note that since the receiver's real output is displayed as the "I" data, when the center frequency is 0, the Q Only input appears as the "I" data.

Key Path	Input/Output, I/Q, I/Q Path
----------	------------------------------------

Input/Output

Example	Set the input to be only the Q channel. FEED:IQ:TYPE QONL
Initial S/W Revision	Prior to A.02.00

Independent I and Q

Sets the signal input to be both the I and Q channels, but as independent inputs. It is equivalent to treating I as channel 1 and Q as channel 2 in an oscilloscope. Each channel's data is still complex. When the center frequency is 0 the imaginary part will always be zero, but for any other center frequency both the real and imaginary parts will be significant.

This selection is only available in VXA.

Key Path	Input/Output, I/Q, I/Q Path
Example	Turn on both I and Q channels and treat I as channel 1 and Q as channel 2. FEED:IQ:TYPE IND
Notes	The Independent I and Q selection is only available in GPVSA
Readback Text	Ind I/Q
Initial S/W Revision	Prior to A.02.00

I Setup

Access the channel setup parameters for the I channel.

Key Path	Input/Output, I/Q
Initial S/W Revision	Prior to A.02.00

I Differential Input

Selects differential input on or off for the I channel. For differential input (also called balanced input), the analyzer uses both main and complementary ports. When differential input is off (also called single-ended or unbalanced input), the analyzer uses only the main port.

Key Path	Input/Output, I/Q, I Setup
Remote Command	:INPut:IQ[:I]:DIFFerential OFF ON 0 1 :INPut:IQ[:I]:DIFFerential?
Example	Put the I channel in Differential Input mode INP:IQ:DIFF ON
Notes	When Differential Input = On, the analyzer will check for attenuation mismatches between the I and I-bar ports. If the difference in attenuation values exceeds 0.5 dB an error condition will be set.

Couplings	Some active probes include built-in differential capability. When one of these probes is sensed, this key is disabled. Since the differential capability is handled in the probe, the Analyzer will use only the main port and the key will show that the Analyzer's Differential Input mode is Off (indicating that the complementary port not in use). When Q Same as I is On, the value set for I will also be copied to Q.
Preset	Off
State Saved	Yes This is unaffected by a Preset but is set to the default value on a "Restore Input/Output Defaults" or "Restore System Defaults->All"
Range	Off On
Initial S/W Revision	Prior to A.02.00

Remote Command	: INPut [1] : IQ: BALanced [: STATE] OFF ON 0 1 : INPut [1] : IQ: BALanced [: STATE] ?
Notes	This backwards compatibility SCPI command was for an instrument without independent settings for the I and Q channels. Therefore, it is tied only to the I channel and does not provide an equivalent for the Q channel. For proper operation of the backwards compatibility command Q Same as I should be set to On.
Preset	OFF
Initial S/W Revision	Prior to A.02.00

I Input Z

Selects the input impedance for the I channel. The impedance applies to both the I and I-bar ports.

The input impedance controls the hardware signal path impedance match. It is not used for converting voltage to power. The voltage to power conversion always uses the Reference Z parameter. The Reference Z parameter applies to both I and Q channels.

Key Path	Input/Output, I/Q, I Setup
Remote Command	: INPut [1] : IQ [: I] : IMPedance LOW HIGH : INPut [1] : IQ [: I] : IMPedance?
Example	Set the I channel input impedance to 1 M Ω INP:IQ:IMP HIGH
Notes	LOW = 50 Ω , HIGH = 1 M Ω
Couplings	Input impedance is a built-in characteristic of a probe. Therefore, whenever a probe is sensed, this key is disabled and the value is set to match the probe. When no probe is sensed on Q and Q Same as I is On, the value set for I will also be copied to Q.

Input/Output

Preset	LOW
State Saved	Yes This is unaffected by a Preset but is set to the default value on a "Restore Input/Output Defaults" or "Restore System Defaults->All"
Range	50 Ω 1 M Ω
Initial S/W Revision	Prior to A.02.00

I Skew

Sets the skew factor for the I channel. The skew will shift the channel's data in time. Use this to compensate for differences in the electrical lengths of the input paths due to cabling.

Key Path	Input/Output, I/Q, I Setup
Remote Command	[:SENSE] :CORRection:IQ [:I] :SKEW <seconds> [:SENSE] :CORRection:IQ [:I] :SKEW?
Example	Delay the data for the I channel by 10 ns. CORR:IQ:SKEW 10 ns
Preset	0
State Saved	Yes This is unaffected by Preset but is set to the default value on a "Restore Input/Output Defaults" or "Restore System Defaults->All"
Range	0 s to 100 ns
Initial S/W Revision	Prior to A.02.00

I Probe

Access the probe setup parameters for the I channel. See ["I/Q Probe Setup" on page 982](#).

Key Path	Input/Output, I/Q, I Setup
State Saved	No
Readback Text	[<I port probe id>] This is reporting the type of probe sensed on the I port. There is no parameter for overriding what is sensed.
Initial S/W Revision	Prior to A.02.00

Combined Differential/Input Z (Remote Command Only)

This is Remote Command only (no front panel) and is for backwards compatibility only. It combines the

Differential Input and Input Z selections into a single SCPI command.

Remote Command	:INPut:IMPedance:IQ U50 B50 U1M B1M :INPut:IMPedance:IQ?
Example	:INPut:IMPedance:IQ U50 This is equivalent to the following two SCPI commands: :INP:IQ:DIFF OFF :INP:IQ:IMP 50
Notes	The enum values translate as follows: U50: Differential Input = Off, Input Z = 50Ω B50: Differential Input = On, Input Z = 50Ω U1M: Differential Input = Off, Input Z = 1 MΩ B1M: Differential Input = On, Input Z = 1 MΩ This command is for backwards compatibility. It combines the Input Z (50Ω or 1 MΩ) parameter with the Differential Input (Off = "Unbalanced", On = "Balanced") parameter into a single enumeration. This backwards compatibility SCPI command was for an instrument without independent settings for the I and Q channels. Therefore, it is tied only to the I channel and does not provide an equivalent for the Q channel. For proper operation of the backwards compatibility command Q Same as I should be set to On. Also, note the subtle difference between this SCPI command and the backwards compatibility command for Input Z. The Input Z SCPI has "IQ" before "IMP" while this command has that order reversed.
Couplings	This command does not have an independent parameter, but instead is tied to the Differential Input and Input Z parameters. The coupling for those parameters apply to this command too.
Preset	U50
Initial S/W Revision	Prior to A.02.00

Q Setup

Access the channel setup parameters for the Q channel.

Key Path	Input/Output, I/Q
Readback Text	When Q Same as I is On the readback is "Q Same as I".
Initial S/W Revision	Prior to A.02.00

Q Same as I

Many, but not all, usages require the I and Q channels have an identical setup. To simplify channel setup, the Q Same as I will cause the Q channel parameters to be mirrored from the I channel. That way your

Input/Output

only need to set up one channel (the I channel). The I channel values are copied to the Q channel, so at the time Q Same as I is turned off the I and Q channel setups will be identical. This does not apply to Probe settings or to parameters that determined by the probe.

Key Path	Input/Output, I/Q, Q Setup
Remote Command	:INPut:IQ:MIRROred OFF ON 0 1 :INPut:IQ:MIRROred?
Example	Turn off the mirroring of parameters from I to Q. INP:IQ:MIRR OFF
Couplings	Only displayed for the Q channel. When Yes, the I channel values for some parameters are mirrored (copied) to the Q channel. However, when a parameter is determined by the type of probe and a probe is sensed, the probe setting is always used and the I channel setting is ignored. The following parameters are mirrored: Differential Input (when not determined by probe) Input Z (when not determined by probe)
Preset	This is unaffected by a Preset but is set to the default value (Q Same as I set to "On") on a "Restore Input/Output Defaults" or "Restore System Defaults->All"
State Saved	Saved in instrument state.
Range	On Off
Readback Text	"Q Same as I" when On, otherwise none.
Initial S/W Revision	Prior to A.02.00

Q Differential Input

Selects differential input on or off for the Q channel. For differential input (also called balanced input), the analyzer uses both the Q and Q-bar ports. When differential input is off (also called single-ended or unbalanced input), the analyzer uses only the Q port.

Key Path	Input/Output, I/Q, Q Setup
Remote Command	:INPut:IQ:Q:DIFFerential OFF ON 0 1 :INPut:IQ:Q:DIFFerential?
Example	Put the Q channel in Differential Input mode INP:IQ:Q:DIFF ON
Notes	When Differential Input = On, the analyzer will check for attenuation mismatches between the Q and Q-bar ports. If the difference in attenuation values exceeds 0.5 dB an error condition will be set.

Couplings	Some active probes include built-in differential capability. When one of these probes is sensed, this key is disabled. Since the differential capability is handled in the probe, the Analyzer will use only the main port and the key will show that the Analyzer's Differential Input mode is Off (indicating that the complementary port not in use). When a differential probe is not sensed and Q Same as I is On, the value set for I will be copied to Q. This key is disabled when Q Same as I is On.
Preset	Off
State Saved	On This is unaffected by a Preset but is set to the default value on a "Restore Input/Output Defaults" or "Restore System Defaults->All"
Range	Off On
Initial S/W Revision	Prior to A.02.00

Q Input Z

Selects the input impedance for the Q channel. The impedance applies to both the Q and Q-bar ports.

The input impedance controls the hardware signal path impedance match. It is not used for converting voltage to power. The voltage to power conversion always uses the Reference Z parameter. The Reference Z parameter applies to both I and Q channels.

Key Path	Input/Output, I/Q, Q Setup
Remote Command	: INPut [1] : IQ:Q: IMPedance LOW HIGH : INPut [1] : IQ:Q: IMPedance?
Example	Set the Q channel input impedance to 1 M Ω INP:IQ:Q:IMP HIGH
Notes	LOW = 50 Ω HIGH = 1 M Ω
Couplings	Input impedance is a built-in characteristic of a probe. Therefore, whenever a probe is sensed, this key is disabled and the value is set to match the probe. When no probe is sensed and Q Same as I is On, the value set for I will also be copied to Q. This key is disabled when Q Same as I is On.
Preset	LOW
State Saved	On This is unaffected by Preset but is set to the default value on a "Restore Input/Output Defaults" or "Restore System Defaults->All"
Range	50 Ω 1 M Ω
Initial S/W Revision	Prior to A.02.00

Q Skew

Sets the skew factor for the Q channel. The skew will shift the channel's data in time. Use this to

Input/Output

compensate for differences in the electrical lengths of the input paths due to cabling and probes.

Key Path	Input/Output, I/Q, Q Setup
Remote Command	<code>[:SENSe] :CORRection:IQ:Q:SKEW <seconds></code> <code>[:SENSe] :CORRection:IQ:Q:SKEW?</code>
Example	Delay the data for the Q channel by 10 ns. <code>CORR:IQ:Q:SKEW 10 ns</code>
Preset	0
State Saved	Yes This is unaffected by a Preset but is set to the default value on a "Restore Input/Output Defaults" or "Restore System Defaults->All"
Range	0 s to 100 ns
Initial S/W Revision	Prior to A.02.00

Q Probe

Accesses the probe setup parameters for the Q channel. See [“I/Q Probe Setup” on page 982](#).

Key Path	Input/Output, I/Q, Q Setup
State Saved	No
Readback Text	<code>[<Q port probe id>]</code> This is reporting the type of probe sensed on the Q port. There is no parameter for overriding what is sensed.
Initial S/W Revision	Prior to A.02.00

I/Q Probe Setup

The set of I/Q probe setup parameters will change based on the type of probe that is sensed. All probe types have the Attenuation parameter, and all probe types can be calibrated. The remaining parameters are only available for some probe types and will not be shown when not available. The probe type is determined by and reported for only for the I and Q ports, never the I-bar or Q-bar ports. The menu title will be "`<ch>: <probe id>`", where "`<ch>`" is either "I" or "Q" and "`<probe id>`" is the type of probe. For example, for the I Probe setup with an Agilent 1130A probe connected to the I port, the title will be "I: 1130A".

Probe calibration data is stored for each probe type for each channel. When no probe is sensed, the probe type "Unknown" is used, and this is also treated like a probe type with its own calibration data. When a probe is changed, the calibration data for that probe type for that port is restored. An advisory message will be displayed showing the new probe type and the calibration status. The calibration data is stored permanently (survives a power cycle) and is not affected by a Preset or any of the Restore commands. When the probe has EEPROM identification (most newer Agilent probes have this), the calibration data is stored by probe serial number and port, so if you have two probes of the same type, the correct calibration data will be used for each. For probes that do not have EEPROM identification, the

calibration data is stored by probe type and port and the instrument cannot distinguish between different probes of the same type. In all cases (with or without EEPROM identification), the calibration data is port specific, so it will not follow a specific probe from port to port if the probe is moved.

The "Unknown" probe type is used whenever no probe is sensed. When no calibration data exists for "Unknown" the latest cable calibration data is used (see Section [“I/Q Guided Calibration” on page 987](#)).

Attenuation

The attenuation is part of the calibration data stored with the probe type and is initially the value that was returned by the last calibration. You can modify this value and any changes will be stored with the calibration data and will survive power cycles and presets. When a probe calibration is performed the attenuation value will be overwritten by the calibration.

Key Path	Input/Output, I/Q, I Setup Q Setup, I Probe Q Probe
Remote Command	[:SENSE] :CORRection:IQ:I Q:ATTenuation:RATio <real> [:SENSE] :CORRection:IQ:I Q:ATTenuation:RATIO?
Example	Set the attenuation for the current I probe to 100.00:1. CORR:IQ:I:ATT:RAT 100
Notes	Each probe type has its own attenuation setting. As probes are changed the attenuation value will reflect the new probe's setting. Changing the attenuation affects only the current probe type's setting and leaves all others unchanged.
Preset	Each probe type has its own default. The default for the "Unknown" probe type is 1:1.
State Saved	Saved with probe calibration data. It survives a power cycle and is not affected by a Preset or Restore.
Range	0.001 to 10000
Initial S/W Revision	Prior to A.02.00

Remote Command	[:SENSE] :CORRection:IQ:I Q:ATTenuation <rel_ampl> [:SENSE] :CORRection:IQ:I Q:ATTenuation?
Example	Set the attenuation for the current I probe type to 100.00:1. CORR:IQ:I:ATT 20 dB
Range	-60 dB to +80 dB
Initial S/W Revision	Prior to A.02.00

Offset

Some active probes have DC offset capability. When one of these probes is connected this control will be visible. The signal is adjusted for the DC offset before entering the analyzer's port. This allows for removal of a DC offset before hitting the analyzer's input port voltage limits. For example, a signal that varies 1 V peak-to-peak with a DC offset equal to the analyzer's max input voltage would exceed the input limits of the analyzer for half its cycle. Removing the DC offset allows the analyzer to correctly

Input/Output

process the entire signal.

Key Path	Input/Output, I/Q, I Setup Q Setup, I Probe Q Probe
Remote Command	:INPut:OFFSet:I Q <voltage> :INPut:OFFSet:I Q?
Example	Remove a DC offset of -0.5 V from the I channel input. INP:OFFS:I-0.5
Notes	Only some probe types support Offset. For those that do, each probe type has its own Offset setting. As probes are changed the Offset value will reflect the new probe's setting. Changing the Offset affects only the current probe type's setting and leaves all others unchanged.
Preset	0 V
State Saved	Saved with probe calibration data. It survives power cycle and is not affected by Preset or Restore.
Range	-18 V to +18 V
Initial S/W Revision	Prior to A.02.00

Coupling

Some probe types allow coupling to reject low frequencies. This will filter out the DC component of a signal that is composed of a DC bias plus some AC signal. This control is visible only for probe types that have this capability.

Key Path	Input/Output, I/Q, I Setup Q Setup, I Probe Q Probe
Remote Command	:INPut:COUPling:I Q DC LFR1 LFR2 :INPut:COUPling:I Q?
Example	Set the probe to low frequency rejection below 1.7 Hz. INP:COUP:I LFR1
Notes	Only some probe types support Coupling. For those that do, each probe type has its own Coupling setting. As probes are changed the Coupling value will reflect the new probe's setting. Changing the Coupling affects only the current probe type's setting and leaves all others unchanged.
Preset	DC
State Saved	Saved with probe calibration data. It survives a power cycle and is not affected by a Preset or Restore.
Range	DC AC 1.7 Hz LFR1 AC 0.14 Hz LFR2
Readback Text	DC LFR1 LFR2
Initial S/W Revision	Prior to A.02.00

DC

Turns off low frequency rejection, allowing signals down to DC.

Key Path	Input/Output, I/Q, I Setup Q Setup, I Probe Q Probe, Coupling
Example	Turn off low frequency rejection on the I channel INP:COUP:I DC
Initial S/W Revision	Prior to A.02.00

LFR1

Turns on low frequency rejection, rejecting signal component lower than 1.7 Hz.

Key Path	Input/Output, I/Q, I Setup Q Setup, I Probe Q Probe, Coupling
Example	Turn on low frequency rejection on the I channel for frequencies lower than 1.7 Hz INP:COUP:I LFR1
Initial S/W Revision	Prior to A.02.00

LFR2

Turns on low frequency rejection, rejecting signal component lower than 0.14 Hz.

Key Path	Input/Output, I/Q, I Setup Q Setup, I Probe Q Probe, Coupling
Example	Turn on low frequency rejection on the I channel for frequencies lower than 0.14 Hz INP:COUP:I LFR2
Initial S/W Revision	Prior to A.02.00

Calibrate

Invokes the guided probe calibration. The guided probe calibration is context sensitive and depends on the channel (I or Q) and the Differential Input state. The calibration is only performed on the selected channel. When Differential Input is on, both the probe attached to the main port and the probe attached to the complementary port are calibrated. When Differential Input is off, only the probe attached to the main port is calibrated. See [“I/Q Guided Calibration” on page 987](#).

Key Path	Input/Output, I/Q, I Setup Q Setup, I Probe Q Probe, Coupling
----------	--

Input/Output

Readback Text	The last calibration date, or if no calibration exists, "(empty)". Last: <cal date> <cal time> Example: Last: 8/22/2007 1:02:49 PM
Initial S/W Revision	Prior to A.02.00

Clear Calibration

Clears the calibration data for the current port and probe. It does not clear the data for other probe types or other ports. If the sensed probe has EEPROM identification, only the data for that specific probe is cleared. After this command has completed, the probe calibration state will be the same as if no probe calibration had ever been performed for the specified channel and probe. The probe attenuation will be the default value for that probe type and the Cable Calibration frequency response corrections will be used. This command is dependent on the Differential Input state. When Differential Input is on, both the data for the probe attached to the main port and the data for the probe attached to the complementary port are cleared. When Differential Input is off, only data for the probe attached to the main port is cleared.

Key Path	Input/Output, I/Q, I Setup Q Setup, I Probe Q Probe
Remote Command	:CALibration:IQ:PROBe:I Q:CLEar
Example	Clear the calibration data for the I channel and the current probe (with EEPROM identification) or probe type (without EEPROM identification). :CAL:IQ:PROBe:I:CLE
Initial S/W Revision	Prior to A.02.00

Reference Z

Sets the value of the impedance to be used in converting voltage to power for the I and Q channels. This does not change the hardware's path impedance (see "[I Input Z](#)" on page 977 Input Z).

Key Path	Input/Output, I/Q
Remote Command	:INPut:IMPedance:REFerence <integer> :INPut:IMPedance:REFerence?
Example	Set the I/Q reference impedance to 50 Ω INP:IMP:REF 50
Preset	50 Ω
State Saved	Yes This is unaffected by a Preset but is set to the default value on a "Restore Input/Output Defaults" or "Restore System Defaults->All"

Range	1 Ω to 1 M Ω
Initial S/W Revision	Prior to A.02.00

I/Q Cable Calibrate...

Invokes the guided cable calibration. The guided cable calibration steps the user through a calibration of all ports (I, I-bar, Q, and Q-bar) using just a cable (no probe attached). See “I/Q Cable Calibrate...” on page 988 for more information.

Key Path	Input/Output, I/Q
Initial S/W Revision	Prior to A.02.00

I/Q Guided Calibration

Calibrating the Baseband I/Q ports requires several steps and manual connections. The Guided Calibration will interactively step a user through the required steps, displaying diagrams to help with the connections. The steps will vary depending on the setup.

In the Guided Calibration windows, the date and time of the last calibration are displayed. If any of the items listed are displayed in yellow, this indicates that the calibration for that item is inconsistent with the latest calibration, and you should complete the entire calibration process before you exit the calibration.

I/Q Isolation Calibration

The I/Q Isolation Calibration must be run before calibrating any port with either the I/Q Cable Calibration or I/Q Probe Calibration. This calibration is performed with nothing connected to any of the front panel I/Q ports. This is the first step in both the I/Q Cable Calibration and the I/Q Probe Calibration.

Next

Perform the I/Q Isolation calibration.

Key Path	Input/Output, I/Q, I/Q Cable Calibration
Remote Command	:CALibration:IQ:ISOLation
Example	CAL:IQ:ISOL
Notes	All front panel I/Q ports must not be connected to anything.
Notes	All cables and probes should be disconnected from the I/Q ports before issuing the SCPI command.
State Saved	No.
Initial S/W Revision	Prior to A.02.00

Exit

Exits the calibration procedure. All ports calibrated before pressing Exit will use the newly acquired calibration

Input/Output

data.

Key Path	Input/Output, I/Q, I/Q Cable Calibration
Notes	Using the Exit button will not restore the calibration data to the state prior to entering the guided calibration. Once a port is calibrated the data is stored immediately and the only way to change it is to redo the calibration step. When the calibration may be left in an inconsistent state, a confirmation dialog will be displayed (see “Exit Confirmation” on page 999).
Initial S/W Revision	Prior to A.02.00

I/Q Isolation Calibration Time (Remote Command Only)

Returns the last date and time that the I/Q Isolation Calibration was performed. This is a remote query command only.

Remote Command	:CALibration:IQ:ISOLation:TIME?
Example	:CAL:IQ:ISOL:TIME?
Notes	This returns 6 integer values: year, month, day, hour, minute, second. When no calibration has been performed, all values will be 0.
Initial S/W Revision	A.02.00

I/Q Cable Calibrate...

The I/Q cable calibration creates correction data for each of the front panel I/Q ports. This calibration data is used whenever no probe specific calibration data is available. It is important that all ports are calibrated using the same short BNC cable so that the data is comparable from port to port.

The guided calibration (front panel only) will show connection diagrams and guide the user through the isolation calibration and calibrating each port. The calibration data for each port is stored separately, so as soon as a port is calibrated that data is saved and will be used. If a user presses "Exit" to exit the calibration process, the data for the ports already completed will still be used. It is recommended that a calibration be completed once started, or if exited, that it be properly done before the next use of the I/Q ports. The "Next" button will perform the calibration for the current port and then proceed to the next step in the calibration procedure. The "Back" button will return to the prior port in the procedure. Both softkeys and dialog buttons are supplied for ease of use. The dialog buttons are for mouse use and the softkeys for front panel use.

The calibration can also be done via SCPI, but no connection diagrams will be shown. The user will have to make the correct connections before issuing each port calibration command. Again, it is recommended that all ports be calibrated at the same time.

The instrument state remains as it was prior to entering the calibration procedure except while a port is actually being calibrated. Once a port is calibrated it returns to the prior state. A port calibration is in process only from the time the "Next" button is pressed until the next screen is shown. For SCPI, this corresponds to the time from issuing the CAL:IQ:FLAT:I|IB|Q|QB command until the operation is complete.

For example, if the prior instrument state is Cal Out = Off, Input = I+jQ, and Differential = Off, then up

until the time the "Next" button is pressed the I Input and Q Input LEDs are on and the Cal Out, I-bar Input and Q-bar Input LEDs are off. Once the "Next" button is pressed for the I port calibration, only the Cal Out and I Input LEDs will be on and the others will be off. When the screen progresses to the next step ("Next" button again enabled), the prior state is restored and only the I Input and Q Input LEDs are on (Cal Out is off again).

The last calibration date and time for each port will be displayed. Any calibrations that are more than a day older than the most recent calibration will be displayed with the color amber.

Key Path	Input/Output, I/Q
Initial S/W Revision	Prior to A.02.00

I Port

The I port calibration is performed with the front panel's I port connected via a short BNC cable to the Cal Out port. The guided calibration will show a diagram of the required connections.

Back

Return to the prior step in the calibration procedure.

Key Path	Input/Output, I/Q, Q Setup, Q Probe, Calibrate
Initial S/W Revision	Prior to A.02.00

Next

Perform the I port calibration.

Key Path	Input/Output, I/Q, I/Q Cable Calibrate...
Remote Command	:CALibration:IQ:FLATness:I
Example	CAL:IQ:FLAT:I
Notes	The recommended procedure is to use the same BNC cable to calibrate all I/Q ports. All I/Q ports should be calibrated sequentially during the procedure. The calibration data is saved as soon as the port is calibrated and will survive power cycles. It is not reset by any preset or restore data commands.
Notes	The I port must be connected to the Cal Out port before issuing the SCPI command.
State Saved	No.
Initial S/W Revision	Prior to A.02.00

Exit

Exit the calibration procedure. All ports calibrated before pressing Exit will use the newly acquired calibration data.

Key Path	Input/Output, I/Q, I/Q Cable Calibrate...
----------	--

Input/Output

Notes	Using the Exit button will not restore the calibration data to the state prior to entering the guided calibration. Once a port is calibrated the data is stored immediately and the only way to change it is to redo the calibration step. When the calibration may be left in an inconsistent state, a confirmation dialog will be displayed (see “Exit Confirmation” on page 999).
Initial S/W Revision	Prior to A.02.00

I-bar Port

The I-bar port calibration is performed with the front panel's I-bar port connected via a short BNC cable to the Cal Out port. The guided calibration will show a diagram of the required connections.

Back

Return to the prior step in the calibration procedure.

Key Path	Input/Output, I/Q, I/Q Cable Calibration
Notes	Using the Back button will not restore the calibration data to a prior state. Once a port is calibrated the data is stored immediately and the only way to change it is to redo the calibration step. The Back button allows the user to go back to a prior step to redo that calibration step.
Initial S/W Revision	Prior to A.02.00

Next

Perform the I-bar port calibration.

Key Path	Input/Output, I/Q, I/Q Cable Calibrate...
Remote Command	:CALibration:IQ:FLATness:IBAR
Example	CAL:IQ:FLAT:IBAR
Notes	The recommended procedure is to use the same BNC cable to calibrate all I/Q ports. All I/Q ports should be calibrated sequentially during the procedure. The calibration data is saved as soon as the port is calibrated and will survive power cycles. It is not reset by any preset or restore data commands.
Notes	The I-bar port must be connected to the Cal Out port before issuing the SCPI command.
State Saved	No
Initial S/W Revision	Prior to A.02.00

Exit

Exit the calibration procedure. All ports calibrated before pressing Exit will use the newly acquired calibration data.

Key Path	Input/Output, I/Q, I/Q Cable Calibrate...
----------	--

Notes	Using the Exit button will not restore the calibration data to the state prior to entering the guided calibration. Once a port is calibrated the data is stored immediately and the only way to change it is to redo the calibration step. When the calibration may be left in an inconsistent state, a confirmation dialog will be displayed (see “Exit Confirmation” on page 999).
Initial S/W Revision	Prior to A.02.00

Q Port

The Q port calibration is performed with the front panel's Q port connected via a short BNC cable to the Cal Out port. The guided calibration will show a diagram of the required connections.

Back

Return to the prior step in the calibration procedure.

Key Path	Input/Output, I/Q, I/Q Cable Calibrate...
Notes	Using the Back button will not restore the calibration data to a prior state. Once a port is calibrated the data is stored immediately and the only way to change it is to redo the calibration step. The Back button allows the user to go back to a prior step to redo that calibration step.
Initial S/W Revision	Prior to A.02.00

Next

Perform the Q port calibration.

Key Path	Input/Output, I/Q, I/Q Cable Calibrate...
Remote Command	:CALibration:IQ:FLATness:Q
Example	CAL:IQ:FLAT:Q
Notes	The recommended procedure is to use the same BNC cable to calibrate all I/Q ports. All I/Q ports should be calibrated sequentially during the procedure. The calibration data is saved as soon as the port is calibrated and will survive power cycles. It is not reset by any preset or restore data commands.
Notes	The Q port must be connected to the Cal Out port before issuing the SCPI command.
State Saved	No
Initial S/W Revision	Prior to A.02.00

Exit

Exit the calibration procedure. All ports calibrated before pressing Exit will use the newly acquired calibration data.

Key Path	Input/Output, I/Q, I/Q Cable Calibrate...
----------	--

Input/Output

Notes	Using the Exit button will not restore the calibration data to the state prior to entering the guided calibration. Once a port is calibrated the data is stored immediately and the only way to change it is to redo the calibration step. When the calibration may be left in an inconsistent state, a confirmation dialog will be displayed (see “Exit Confirmation” on page 999).
Initial S/W Revision	Prior to A.02.00

Q-bar Port

The Q-bar port calibration is performed with the front panel's Q-bar port connected via a short BNC cable to the Cal Out port. The guided calibration will show a diagram of the required connections.

Back

Return to the prior step in the calibration procedure.

Key Path	Input/Output, I/Q, I/Q Cable Calibrate...
Notes	Using the Back button will not restore the calibration data to a prior state. Once a port is calibrated the data is stored immediately and the only way to change it is to redo the calibration step. The Back button allows the user to go back to a prior step to redo that calibration step.
Initial S/W Revision	Prior to A.02.00

Next

Perform the Q-bar port calibration.

Key Path	Input/Output, I/Q, I/Q Cable Calibrate...
Remote Command	:CALibration:IQ:FLATness:QBAR
Example	CAL:IQ:FLAT:QBAR
Notes	The recommended procedure is to use the same BNC cable to calibrate all I/Q ports. All I/Q ports should be calibrated sequentially during the procedure. The calibration data is saved as soon as the port is calibrated and will survive power cycles. It is not reset by any preset or restore data commands.
Notes	The Q-bar port must be connected to the Cal Out port before issuing the SCPI command.
State Saved	No
Initial S/W Revision	Prior to A.02.00

Exit

Exit the calibration procedure. All ports calibrated before pressing Exit will use the newly acquired calibration data.

Key Path	Input/Output, I/Q, I/Q Cable Calibrate...
----------	--

Notes	Using the Exit button will not restore the calibration data to the state prior to entering the guided calibration. Once a port is calibrated the data is stored immediately and the only way to change it is to redo the calibration step. When the calibration may be left in an inconsistent state, a confirmation dialog will be displayed (see “Exit Confirmation” on page 999).
Initial S/W Revision	Prior to A.02.00

I/Q Cable Calibration Time (Remote Command Only)

Returns the last date and time that the I/Q Cable Calibration was performed for a specific port. This is a remote query command only.

Remote Command	:CALibration:IQ:FLATness:I IBAR Q QBAR:TIME?
Example	:CAL:IQ:FLAT:I:TIME?
Notes	This returns 6 integer values: year, month, day, hour, minute, second. When no calibration has been performed, all values will be 0.
Initial S/W Revision	A.02.00

I/Q Probe Calibration

The I/Q probe calibration creates correction data for one of the front panel I/Q channels. When the probe has EEPROM identification, the data is unique to that specific probe. When the probe does not have EEPROM identification, the data will be used for all probes of the same type. The data is also unique to the channel, so calibration data for the I channel will not be used for the Q channel and vice versa.

The guided calibration (front panel only) will show connection diagrams and guide the user through the I/Q Isolation Calibration and through calibrating each port. The calibration data for each port is stored separately, so as soon as a port is calibrated that data is saved and will be used. If a user presses "Exit" to exit the calibration process, the data for the port already completed will still be used. It is recommended that a calibration be completed once started, or if exited, that it be properly done before the next use of the probe. The "Next" button will perform the calibration for the current port and then proceed to the next step in the calibration procedure. The "Back" button will return to the prior port in the procedure. Both softkeys and dialog buttons are supplied for ease of use. The dialog buttons are for mouse use and the softkeys for front panel use.

The calibration can also be done via SCPI, but no connection diagrams will be shown. The user will have to make the correct connections before issuing each port calibration command. Again, it is recommended that all ports be calibrated at the same time.

For Active probes or when Differential is Off, only the main port is calibrated, otherwise both the main and complementary ports are calibrated.

The instrument state remains as it was prior to entering the calibration procedure except while a port is actually being calibrated. Once a port is calibrated it returns to the prior state. A port calibration is in process only from the time the "Next" button is pressed until the next screen is shown. For SCPI, this corresponds to the time from issuing the CAL:IQ:PROB:I|IB|Q|QB command until the operation is complete.

For example, if the prior instrument state is Cal Out = Off, Input = I+jQ, and Differential = Off, then up

Input/Output

until the time the "Next" button is pressed the I Input and Q Input LEDs are on and the Cal Out, I-bar Input and Q-bar Input LEDs are off. Once the "Next" button is pressed for the I port calibration, only the Cal Out and I Input LEDs will be on and the others will be off. When the screen progresses to the next step ("Next" button again enabled), the prior state is restored and only the I Input and Q Input LEDs are on (Cal Out is off again).

The last calibration date and time for each relevant port will be displayed. For passive probes with Differential On, any calibration that is more than a day older than the most recent calibration will be displayed with the color amber.

I Port

The I port calibration is performed with the probe body attached to the front panel's I port and the probe tip connected via an adapter to the Cal Out port. The guided calibration will show a diagram of the required connections.

Show Adapter

Show a connection diagram and instructions for the probe and adapter. See ["Show Adapter Screen" on page 998](#).

Key Path	Input/Output, I/Q, I Setup, I Probe, Calibrate
Notes	Either a passive or an active probe adapter diagram will be shown, depending on the type of probe attached.
Initial S/W Revision	Prior to A.02.00

Back

Return to the prior step in the calibration procedure.

Key Path	Input/Output, I/Q, Q Setup, Q Probe, Calibrate
Initial S/W Revision	Prior to A.02.00

Next

Perform the I port calibration.

Key Path	Input/Output, I/Q, I Setup, I Probe, Calibrate
Remote Command	<code>:CALibration:IQ:PROBE:I</code>
Example	<code>CAL:IQ:PROB:I</code>
Notes	The I port must be connected to the Cal Out port before issuing the SCPI command. The calibration data is saved as soon as the port is calibrated and will survive power cycles. It is not reset by any preset or restore data commands.
State Saved	No
Initial S/W Revision	Prior to A.02.00

Exit

Exit the calibration procedure. All ports calibrated before pressing Exit will use the newly acquired calibration data.

Key Path	Input/Output, I/Q, I Setup, I Probe, Calibrate
Notes	Using the Exit button will not restore the calibration data to the state prior to entering the guided calibration. Once a port is calibrated the data is stored immediately and the only way to change it is to redo the calibration step. When the calibration may be left in an inconsistent state, a confirmation dialog will be displayed (see “Exit Confirmation” on page 999).
Initial S/W Revision	Prior to A.02.00

I-bar Port

The I-bar port calibration is performed with the probe body attached to the front panel's I-bar port and the probe tip connected via an adapter to the Cal Out port. The I-bar probe calibration is only available for passive probes with Differential On. The guided calibration will show a diagram of the required connections.

Show Adapter

Show a connection diagram and instructions for the probe and adapter. See [“Show Adapter Screen” on page 998](#).

Key Path	Input/Output, I/Q, I Setup, I Probe, Calibrate
Notes	Either a passive or an active probe adapter diagram will be shown, depending on the type of probe attached.
Initial S/W Revision	Prior to A.02.00

Back

Return to the prior step in the calibration procedure.

Key Path	Input/Output, I/Q, I Setup, I Probe, Calibrate
Notes	Using the Back button will not restore the calibration data to a prior state. Once a port is calibrated the data is stored immediately and the only way to change it is to redo the calibration step. The Back button allows the user to go back to a prior step to redo that calibration step.
Initial S/W Revision	Prior to A.02.00

Next

Perform the I-bar port calibration.

Key Path	Input/Output, I/Q, I Setup, I Probe, Calibrate
Remote Command	:CALibration:IQ:PROBe:IBar
Example	CAL:IQ:PROB:IB

Input/Output

Notes	The I-bar port must be connected to the Cal Out port before issuing the SCPI command. The calibration data is saved as soon as the port is calibrated and will survive power cycles. It is not reset by any preset or restore data commands.
State Saved	No
Initial S/W Revision	Prior to A.02.00

Exit

Exit the calibration procedure. All ports calibrated before pressing Exit will use the newly acquired calibration data.

Key Path	Input/Output, I/Q, I Setup, I Probe, Calibrate
Notes	Using the Exit button will not restore the calibration data to the state prior to entering the guided calibration. Once a port is calibrated the data is stored immediately and the only way to change it is to redo the calibration step. When the calibration may be left in an inconsistent state, a confirmation dialog will be displayed (see “Exit Confirmation” on page 999).
Initial S/W Revision	Prior to A.02.00

Q Port

The Q port calibration is performed with the probe body attached to the front panel's Q port and the probe tip connected via an adapter to the Cal Out port. The guided calibration will show a diagram of the required connections.

Show Adapter

Show a connection diagram and instructions for the probe and adapter. See [“Show Adapter Screen” on page 998](#).

Key Path	Input/Output, I/Q, Q Setup, Q Probe, Calibrate
Notes	Either a passive or an active probe adapter diagram will be shown, depending on the type of probe attached.
Initial S/W Revision	Prior to A.02.00

Back

Return to the prior step in the calibration procedure.

Key Path	Input/Output, I/Q, Q Setup, Q Probe, Calibrate
Initial S/W Revision	Prior to A.02.00

Next

Perform the Q port calibration.

Key Path	Input/Output, I/Q, Q Setup, Q Probe, Calibrate
----------	---

Remote Command	:CALibration:IQ:PROBe:Q
Example	CAL:IQ:PROB:Q
Notes	The Q port must be connected to the Cal Out port before issuing the SCPI command. The calibration data is saved as soon as the port is calibrated and will survive power cycles. It is not reset by any preset or restore data commands.
State Saved	No
Initial S/W Revision	Prior to A.02.00

Exit

Exit the calibration procedure. All ports calibrated before pressing Exit will use the newly acquired calibration data.

Key Path	Input/Output, I/Q, Q Setup, Q Probe, Calibrate
Notes	Using the Exit button will not restore the calibration data to the state prior to entering the guided calibration. Once a port is calibrated the data is stored immediately and the only way to change it is to redo the calibration step. When the calibration may be left in an inconsistent state, a confirmation dialog will be displayed (see “Exit Confirmation” on page 999).
Initial S/W Revision	Prior to A.02.00

Q-bar Port

The Q-bar port calibration is performed with the probe body attached to the front panel's Q-bar port and the probe tip connected via an adapter to the Cal Out port. The Q-bar probe calibration is only available for passive probes with Differential On. The guided calibration will show a diagram of the required connections.

Show Adapter

Show a connection diagram and instructions for the probe and adapter. See [“Show Adapter Screen”](#) on page 998.

Key Path	Input/Output, I/Q, Q Setup, Q Probe, Calibrate
Notes	Either a passive or an active probe adapter diagram will be shown, depending on the type of probe attached.
Initial S/W Revision	Prior to A.02.00

Back

Return to the prior step in the calibration procedure.

Key Path	Input/Output, I/Q, Q Setup, Q Probe, Calibrate
Notes	Using the Back button will not restore the calibration data to a prior state. Once a port is calibrated the data is stored immediately and the only way to change it is to redo the calibration step. The Back button allows the user to go back to a prior step to redo that calibration step.

Input/Output

Initial S/W Revision	Prior to A.02.00
----------------------	------------------

Next

Perform the Q-bar port calibration.

Key Path	Input/Output, I/Q, Q Setup, Q Probe, Calibrate
Remote Command	:CALibration:IQ:PROBe:QBar
Example	CAL:IQ:PROB:QB
Notes	The Q-bar port must be connected to the Cal Out port before issuing the SCPI command. The calibration data is saved as soon as the port is calibrated and will survive power cycles. It is not reset by any preset or restore data commands.
State Saved	No
Initial S/W Revision	Prior to A.02.00

Exit

Exit the calibration procedure. All ports calibrated before pressing Exit will use the newly acquired calibration data.

Key Path	Input/Output, I/Q, Q Setup, Q Probe, Calibrate
Notes	Using the Exit button will not restore the calibration data to the state prior to entering the guided calibration. Once a port is calibrated the data is stored immediately and the only way to change it is to redo the calibration step. When the calibration may be left in an inconsistent state, a confirmation dialog will be displayed (see “Exit Confirmation” on page 999).
Initial S/W Revision	Prior to A.02.00

Show Adapter Screen

When one of the Probe Calibration Show Adapter buttons is pressed, a diagram of the probe with its adapter will be shown. Depending on the type of probe attached, either the Passive Probe Adapter or the Active Probe Adapter diagram will be shown.

I/Q Probe Calibration Time (Remote Command Only)

Return the last date and time that the I/Q Probe Calibration was performed for a specific port. This is a remote query command only.

Remote Command	:CALibration:IQ:PROBe:I IBAR Q QBAR:TIME?
Example	:CAL:IQ:PROB:I:TIME?
Notes	This returns 6 integer values: year, month, day, hour, minute, second. When no calibration has been performed, all values will be 0. The value is specific to both the port and probe, so the value will change as probes are connected or disconnected.

Initial S/W Revision	A.02.00
----------------------	---------

Exit Confirmation

When Exit is pressed during one of the calibration routines, the calibration may be in an inconsistent state with some of the ports having newly measured calibration data and others with old data. If this is the case, a dialog box will appear to confirm that the user really wants to exit. A "Yes" answer will exit the calibration procedure, leaving potentially inconsistent calibration data in place. A "No" answer will return to the calibration procedure.

RF Calibrator

Lets you choose a calibrator signal to look at or turns the calibrator "off" (switches back to the selected input). When one of the calibrator signals is selected, the analyzer routes that signal (an internal amplitude reference) to the analyzer, while leaving the main input selection (RF or I/Q) unchanged.

This function presets to OFF on a Mode Preset, which causes the internal circuitry to switch back to the selected input (RF or I/Q).

Key Path	Input/Output
Remote Command	[:SENSE] :FEED:AREFERENCE REF50 REF4800 OFF [:SENSE] :FEED:AREFERENCE?
Example	FEED:AREF REF50 selects the 50 MHz amplitude reference as the signal input. FEED:AREF REF4800 selects the 4.8 GHz amplitude reference as the signal input FEED:AREF OFF turns the calibrator "off" (switches back to the selected input – RF or I/Q)
Dependencies	Selecting an input (RF or I/Q) turns the Calibrator OFF. This is true whether the input is selected by the keys or with the [:SENSE]:FEED command. The 4.8 GHz internal reference is only available in some models and frequency range options. If the 4.8 GHz reference is not present, the 4.8 GHz softkey will be blanked, and if the REF4800 parameter is sent, the analyzer will generate an error.
Preset	OFF
State Saved	Saved in instruemnt state
Readback	Off, 50 MHz, 4.8 GHz

Input/Output

Backwards Compatibility SCPI	For ESA backwards compatibility, the legacy SCPI command CALibration:SOURce:STATe <boolean> (ESA's Amptd Ref Out SCPI) will still be supported and mapped as follows: When CALibration:SOURce:STATe ON is received [SENSe]:FEED:AREF REF50 will execute When CALibration:SOURce:STATe OFF is received [SENSe]:FEED:AREF OFF will execute When CALibration:SOURce:STATe? is received, 1 will be returned if any of the references is selected and 0 if the Calibrator is "Off"
Initial S/W Revision	Prior to A.02.00

50 MHz

Selects the 50 MHz internal reference as the input signal.

Key Path	Input/Output, RF Calibrator
Example	:FEED:AREF REF50
Readback	50 MHz
Initial S/W Revision	Prior to A.02.00

4.8 GHz

Selects the 4.8 GHz internal reference as the input signal.

Key Path	Input/Output, RF Calibrator
Example	:FEED:AREF REF4800
Dependencies	The 4.8 GHz internal reference is only available in some models and frequency range options. If the 4.8 GHz reference is not present, the 4.8 GHz softkey will be blanked, and if the REF4800 parameter is sent, the analyzer will generate an error.
Readback	4.8 GHz
Initial S/W Revision	Prior to A.02.00
Modified at S/W Revision	A.03.00

Off

Switches the input back to the selected input (RF or I/Q)

Key Path	Input/Output, RF Calibrator
Example	:FEED:AREF OFF
Readback	Off

Initial S/W Revision	Prior to A.02.00
----------------------	------------------

External Gain

Compensates for gain or loss in the measurement system outside the spectrum analyzer. The External Gain is subtracted from the amplitude readout (or the loss is added to the amplitude readout). So, the displayed signal level represents the signal level at the output of the device-under-test, which can be the input of an external device that provides gain or loss.

Entering an External Gain value does not affect the Reference Level, therefore the trace position on screen changes, as do all of values represented by the trace data. Thus, the values of exported trace data, queried trace data, marker amplitudes, trace data used in calculations such as N dB points, trace math, peak threshold, etc., are all affected by External Gain. Changing the External Gain, even on a trace which is not updating, will immediately change all of the above, without new data needing to be taken.

NOTE Changing the External Gain causes the analyzer to immediately stop the current sweep and prepare to begin a new sweep, but the data will not change until the trace data updates, because the offset is applied to the data as it is taken. If a trace is exported with a nonzero External Gain, the exported data will contain the trace data with the offset applied.

In the Spectrum Analyzer mode, a Preamp is the common external device providing gain or loss. In a measurement application mode like GSM or W-CDMA, the gain or loss could be from a BTS (Base Transceiver Station) or an MS (Mobile Station). So in the Spectrum Analyzer mode MS and BTS would be grayed out and the only choice would be Ext Preamp. Similarly in some of the digital communications applications, Ext Preamp will be grayed out and you would have a choice of MS or BTS.

Key Path	Input/Output
Couplings	The Ext Preamp, MS, and BS keys may be grayed out depending on which measurement is currently selected. If any of the grayed out keys are pressed, or the equivalent SCPI command is sent, an advisory message is generated.
Readback	1-of-N selection [variable]
Initial S/W Revision	Prior to A.02.00

Ext Preamp

This function is similar to the reference level offset function. Both affect the displayed signal level. Ref Lvl Offset is a mathematical offset only, no analyzer configuration is affected. Ext Preamp gain is used when determining the auto-coupled value of the Attenuator. The External Gain value and the Maximum Mixer Level settings are both part of the automatic setting equation for the RF attenuation setting. (10 dB of Attenuation is added for every 10 dB of External Gain.)

Note that the Ref Lvl Offset and Maximum Mixer Level are described in the Amplitude section. They are reset by the instrument Preset. The External Preamp Gain is reset by the "Restore Input/Output Defaults" or "Restore System Defaults->All functions. . The External Gain is subtracted from the amplitude readout so that the displayed signal level represents the signal level at the output of the

Input/Output

device-under-test, which is the input of the external device that is providing gain or loss.

Key Path	Input/Output, External Gain
Remote Command	[:SENSe] :CORRection:SA [:RF] :GAIN <rel_ampl> [:SENSe] :CORRection:SA [:RF] :GAIN?
Example	CORR:SA:GAIN 10 sets the Ext Gain value to 10 dB CORR:SA:GAIN -10 sets the Ext Gain value to -10 dB (that is, an attenuation of 10 dB)
Notes	Does not auto return.
Dependencies	The reference level limits are determined in part by the External Gain/Atten, Max Mixer Level, and RF Atten. This key is grayed out in Modes that do not support External Gain
Preset	This is unaffected by Preset but is set to 0 dB on a "Restore Input/Output Defaults" or "Restore System Defaults->All"
State Saved	Saved in instrument state
Min	-81.90 dB
Max	81.90 dB
Readback	Preamp Gain, <Ext Gain value> dB
Backwards Compatibility SCPI	[:SENSe] :CORRection:OFFSet [:MAGNitude]
Initial S/W Revision	Prior to A.02.00

MS

Sets an external gain/attenuation value for MS (Mobile Station) tests.

Key Path	Input/Output, External Gain
Remote Command	[:SENSe] :CORRection:MS [:RF] :GAIN <rel_ampl> [:SENSe] :CORRection:MS [:RF] :GAIN?
Example	CORR:MS:GAIN 10 sets the Ext Gain value to 10 dB CORR:MS:GAIN -10 sets the Ext Gain value to -10 dB (that is, a loss of 10 dB.)
Notes	Does not auto return.
Dependencies	The reference level limits are determined in part by the External Gain, Max Mixer Level, RF Atten This key is grayed out in modes that do not support MS.

Preset	This is unaffected by a Preset but is set to 0 dB on a "Restore Input/Output Defaults" or "Restore System Defaults->All"
State Saved	Saved in instrument state.
Min	-100 dB
Max	100 dB
Readback	MS, <Ext Gain value> dB
Backwards Compatibility SCPI	[[:SENSe]:CORRection:MS[:RF]:LOSS
Backwards Compatibility SCPI	[[:SENSe]:CORRection:MS[:RF]:LOSS <rel_ampl> [:SENSe]:CORRection:MS[:RF]:LOSS? Important notes regarding the alias commands: A positive value of <rel_ampl> in the above command means a loss and a negative value indicates a gain. So, for example, sending the command a) CORR:MS:LOSS 10 dB will set the value on the softkey and the active function to -10 dB since the softkey and the active function always show the Gain. The query CORR:MS:LOSS? returns 10 dB The query CORR:MS:GAIN? returns -10 dB b) CORR:MS:LOSS -10 dB will set the value on the softkey and the active function to 10 dB since the softkey and the active function always show the Gain The query CORR:MS:LOSS? returns -10 dB The query CORR:MS:GAIN? returns 10 dB
Initial S/W Revision	Prior to A.02.00

BTS

Sets an external attenuation value for BTS (Base Transceiver Station) tests.

Key Path	Input/Output, External Gain
Remote Command	[[:SENSe]:CORRection:BTS[:RF]:GAIN <rel_ampl> [:SENSe]:CORRection:BTS[:RF]:GAIN?
Example	CORR:BTS:GAIN 10 sets the Ext Gain value to 10 dB CORR:BTS:GAIN -10 sets the Ext Gain value to -10 dB (that is, a loss of 10 dB.)
Notes	Does not auto return.
Dependencies	The reference level limits are determined in part by the External Gain, Max Mixer Level, RF Atten This key is grayed out in modes that do not support BTS.

Input/Output

Preset	This is unaffected by a Preset but is set to 0 dB on a "Restore Input/Output Defaults" or "Restore System Defaults->All"
State Saved	Saved in instrument state.
Min	-100 dB
Max	100 dB
Readback	BTS, <Ext Gain value> dB
Backwards Compatibility SCPI	[::SENSE]:CORREction:BTS[:RF]:LOSS
Backwards Compatibility SCPI	[::SENSE]:CORREction:BTS[:RF]:LOSS <rel_ampl> [::SENSE]:CORREction:BTS[:RF]:LOSS? Important notes regarding the alias commands: A positive value of <rel_ampl> in the above command means a loss and a negative value indicates a gain. So, for example, sending the command a) CORR:BTS:LOSS 10 dB will set the value on the softkey and the active function to -10 dB since the softkey and the active function always show the Gain. The query CORR:BTS:LOSS? returns 10 dB The query CORR:BTS:GAIN? returns -10 dB b) CORR:BTS:LOSS -10 dB will set the value on the softkey and the active function to 10 dB since the softkey and the active function always show the Gain The query CORR:BTS:LOSS? returns -10 dB The query CORR:BTS:GAIN? returns 10 dB
Initial S/W Revision	Prior to A.02.00

I Ext Gain

This function affects only the I channel input, except when the Input Path is I+jQ. In I+jQ this setting is applied to both I and Q channel inputs. It is not available unless the Baseband I/Q option (BBA) is installed.

Key Path	Input/Output, External Gain
Remote Command	[::SENSE]:CORREction:IQ:I:GAIN <rel_ampl> [::SENSE]:CORREction:IQ:I:GAIN?
Example	Set the I Ext Gain to 10 dB CORR:IQ:I:GAIN 10 Set the I Ext Gain to -10 dB (that is, a loss of 10 dB.) CORR:IQ:I:GAIN -10
Notes	Not available unless option BBA is installed

Preset	0 dB This is unaffected by a Preset but is set to 0 dB on a "Restore Input/Output Defaults" or "Restore System Defaults->All"
State Saved	Saved in instrument state.
Min	-100 dB
Max	100 dB
Readback Text	I Gain, <I Ext Gain> dB
Initial S/W Revision	Prior to A.02.00

Q Ext Gain

This function affects only the Q channel input and only when the Input Path is not I+jQ. It is not available unless the Baseband I/Q option (BBA) is installed.

Key Path	Input/Output, External Gain
Remote Command	[:SENSE] :CORRection:IQ:Q:GAIN <rel_ampl> [:SENSE] :CORRection:IQ:Q:GAIN?
Example	Set the Q Ext Gain to 10 dB CORR:IQ:Q:GAIN 10 Set the Q Ext Gain to -10 dB (that is, a loss of 10 dB.) CORR:IQ:Q:GAIN -10
Notes	Not available unless option BBA is installed.
Preset	0 dB This is unaffected by a Preset but is set to 0 dB on a "Restore Input/Output Defaults" or "Restore System Defaults->All"
State Saved	Saved in instrument state.
Min	-100 dB
Max	100 dB
Readback Text	Q Gain, <I Ext Gain> dB
Initial S/W Revision	Prior to A.02.00

Restore Input/Output Defaults

This selection causes the group of settings and data associated with the **Input/Output** key to be a reset to their default values. In addition, when a Source is installed, licensed and selected, Restore Input/Output defaults will initiate a Source Preset.

This level of Restore System Defaults does not affect any other system settings or mode settings and does not cause a mode switch. All the features described in this section are reset using this key, including

Input/Output

Input Corrections and Data (described in the Corrections section).

Key Path	Input/Output
Example	:SYST:DEF INP presets all the Input/Output variables to their factory default values.
Notes	Refer to the Utility Functions for information about Restore System Defaults and the complete description of the :SYSTem:DEfault INPut: command.
Initial S/W Revision	Prior to A.02.00

Data Source

Gives you the choice of either using a hardware input signal as the input or raw data stored in a data storage buffer from an earlier acquisition. You can also share raw data across certain measurements that support this feature. The measurements must be capable of storing raw data. There are three choices under this menu. You can select "Inputs" which is the same as selecting one of the inputs from the input port, for example RF, AREF, I/Q, or IFALign. Selecting "Capture Buffer" allows you to use data that has been stored earlier in the same measurement or from a previous measurement using the "Current Meas -> Capture Buffer" feature. Selecting "Recorded Data" allows you to playback long data capture records stored in the record buffer.

When you make a recording (see [“Record Data Now” on page 1008](#)) or when you recall a recording (see the Recall section) the data source is automatically set to Recorded Data. You can toggle the data source between Inputs and the current Recording (if there is one). That is, the recording remains in memory until it is replaced by a new recording, or the application is closed.

Key Path	Input/Output
Remote Command	[:SENSe] :FEED:DATA INPut STORed RECorded [:SENSe] :FEED:DATA?
Example	FEED:DATA REC FEED:DATA?
Notes	INPutS = Inputs STORed = Capture Buffer RECorded = Record Data Buffer
Dependencies	Not all inputs are available in all modes. Unavailable keys are grayed out.
Preset	This is unaffected by Preset but is set to INPut on a "Restore Input/Output Defaults" or "Restore System Defaults->All"
State Saved	Saved in instrument state
Readback	Variable
Backwards Compatibility SCPI	[:SENSe]:FEED:SOURce INPut STORed [:SENSe]:FEED:SOURce?

Initial S/W Revision	Prior to A.02.00
----------------------	------------------

Inputs

Sets the measurement to use the input selections (RF, AREF, I/Q)

Key Path	Input/Output, Data Source
Example	FEED:DATA INP causes the measurement to look at the input selection
Notes	Does not auto return.
Readback	Inputs
Initial S/W Revision	Prior to A.02.00

Capture Buffer

Some WCDMA and demod measurements support this feature. This allows sharing of the raw data across certain measurements. If you want to make another measurement on the same signal, you would store that raw data using the "Current Meas -> Capture Buffer" key. Then the data is available for the next measurement to use. You must have raw data stored in the instrument memory before the Capture Buffer choice is available for use.

If you switch to a measurement that does not support this feature, then the instrument switches to use "Inputs" and grays out this key. If the grayed out key is pressed, it generates a message.

Key Path	Input/Output, Data Source
Example	FEED:DATA STOR causes stored measurement data to be used with a different measurement that supports this.
Notes	Does not auto return. This key is grayed out when you switch to a measurement that does not support this feature.
Dependencies	Grayed out in the SA measurement.
Readback	Stored Data
Initial S/W Revision	Prior to A.02.00

Recorded Data

Directs the instrument to get data from the record data buffer in the measurement, rather than from the RF Input Signal.

Key Path	Input/Output, Data Source
Example	FEED:DATA REC causes the measurement to extract data from the record data buffer.
Notes	Does not auto return.
Dependencies	Grayed out in the SA measurement.

Input/Output

Readback	Recorded Data
Initial S/W Revision	Prior to A.02.00

Current Meas -> Capture Buffer

Pressing this key stores the raw data of one measurement in the internal memory of the instrument where it can then be used by a different measurement by pressing "Stored Data". When raw data is stored, then the data source selection switch automatically changes to "Stored Data". Stored raw data cannot be directly accessed by a user. There is no save/recall function to save the raw data in an external media. However if you want to get the stored raw data, you must first perform a measurement using the stored raw data. Now you can access the used raw data, which is the same as stored raw data, using the FETCh or READ commands.

Key Path	Input/Output, Data Source
Remote Command	[:SENSe] :FEED:DATA:STORe
Example	FEED:DATA:STOR stores recorded data
Notes	This is command only, there is no query
Dependencies	Grayed out in the SA measurement.
Backwards Compatibility SCPI	[:SENSe] :FEED:SOURce:STORe
Initial S/W Revision	Prior to A.02.00

Record Data Now

This causes the data source to change to Inputs (if it is not already set) and a recording is made with the current instrument setup. The length of the recording must be specified in advance.

This key changes to **Abort Recording** once the recording process has started. It changes back when the recording is complete.

The following dialogs show the progress of the recording:

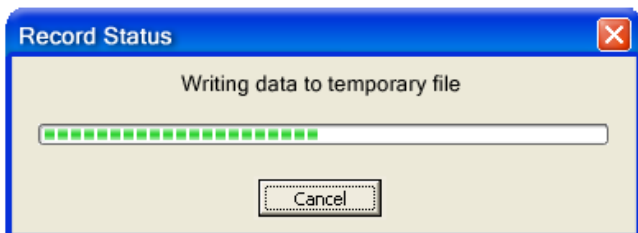
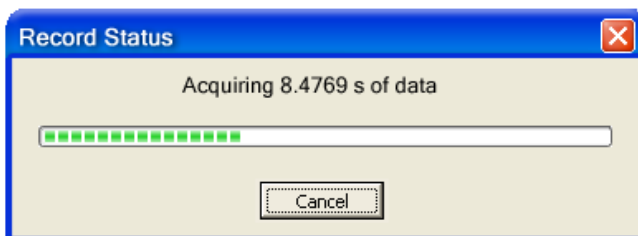

This key is also available in the Sweep/Control menu.

Key Path	Input/Output, Data Source
Mode	VSA
Remote Command	[:SENSe] :RECOrding:INITiate [:IMMediate]
Example	REC:INIT
Notes	This is command only, there is no query. See the Recall functionality to access previously saved data.
Dependencies	Grayed out in the SA measurement.
Couplings	Changes Data source to Recorded Data.
Initial S/W Revision	Prior to A.02.00

Key Path	Input/Output, Data Source
Remote Command	[:SENSe] :RECOrding:ABORt
Example	REC:ABOR
Notes	This is command only, there is no query. The command does nothing if it is sent when there is no recording in progress.
Initial S/W Revision	Prior to A.02.00

Record Length

This specifies the length of the next recording. (You cannot use this to modify the length of the current recording.) The length defaults to seconds, but you can also specify it in points at the current sample rate, or in time records at the current time record length.

Key Path	Input/Output, Data Source
Mode	VSA
Remote Command	[:SENSe] :RECOrding:LENGth <real>, SECOnds RECOrds POINts [:SENSe] :RECOrding:LENGth:STATe MAX MANUal [:SENSe] :RECOrding:LENGth:STATe?
Example	REC:LENG 20,REC REC:LENG 4.1E-4,SEC REC:LENG:STAT MAX REC:LENG:STAT?
Notes	There is no default unit. The unit must be specified. The length command does not have a query form. Length information is queried using the two commands following this table. If set to MAX, all of the available "recording memory" is used.

Input/Output

Preset	50 Records, Manual
State Saved	No
Min	0
Max	Depends on memory available.
Readback	<value><Seconds Points Records>
Initial S/W Revision	Prior to A.02.00

Mode	VSA
Remote Command	[:SENSe] :RECOrding:LENGth:VALue?
Example	REC:LENG:VAL?
Notes	Query Only Returns the first (numeric) parameter of the most recent [:SENSe]:RECOrding:LENGth command.
Preset	50 Records
Initial S/W Revision	Prior to A.02.00

Mode	VSA
Remote Command	[:SENSe] :RECOrding:LENGth:UNIT?
Example	REC:LENG:UNIT?
Notes	Query Only Returns the second parameter of the most recent [:SENSe]:RECOrding:LENGth command. Possible values are SEC REC POIN. If no second parameter was sent, then the return value is SEC.
Preset	RECOrcs
Initial S/W Revision	Prior to A.02.00

Corrections

This key accesses the Amplitude Corrections menu.

Amplitude Corrections arrays can be entered, sent over SCPI, or loaded from a file. They allow you to correct the response of the analyzer for various use cases. The X-series supports four separate Corrections arrays, each of which can contain up to 2000 points. They can be turned on and off individually and any or all can be on at the same time.

Trace data is in absolute units and corrections data is in relative units, but we want to be able to display trace data at the same time as corrections data. Therefore we establish a reference line to be used while building or editing a Corrections table. The reference line is halfway up the display and represents 0 dB of correction. It is labeled "0 dB CORREC". It is drawn in blue.

Corrections data is always in dB. Whatever dB value appears in the correction table represents the correction to be applied to that trace at that frequency. So if a table entry shows 30 dB that means we ADD 30 dB to each trace to correct it before displaying it.

In zero span, where the frequency is always the center frequency of the analyzer, we apply the (interpolated) correction for the center frequency to all points in the trace. In the event where there are two correction amplitudes at the center frequency, we apply the first one in the table.

Note that the corrections are applied as the data is taken; therefore, a trace in **View** (Update Off) will not be affected by changes made to the corrections table after the trace is put in **View**.

Key Path	Input/Output, Corrections
Mode	SA, DVB-T/H, DTMB, SEQAN, TDSCDMA
Dependencies	This key will only appear if you have the proper option installed in your instrument. Amplitude correction may not be available in all modes; if a mode does not support amplitude correction, the Corrections key should be blanked while in that mode. If an application supports corrections but the current measurement does not, then the key should be grayed out in that measurement
Preset	Corrections arrays are reset (deleted) by Restore Input/Output Defaults. They survive shutdown and restarting of the analyzer application, which means they will survive a power cycle.
Initial S/W Revision	A.02.00

Select Correction

Specifies the selected correction. The term "selected correction" is used throughout this document to specify which correction will be affected by the functions.

Key Path	Input/Output, Corrections
Mode	SA
Notes	The selected correction is remembered even when not in the correction menu.
Preset	Set to Correction 1 by Restore Input/Output Defaults
Readback	Correction 1 Correction 2 Correction 3 Correction 4 Correction 5 Correction 6
Initial S/W Revision	A.02.00

Correction On/Off

Turning the Selected Correction on allows the values in it to be applied to the data. This also automatically turns on "Apply Corrections" (sets it to ON), otherwise the correction would not take effect.

A new sweep is initiated if an amplitude correction is switched on or off. Note that changing, sending or loading corrections data does NOT directly initiate a sweep, however in general these operations will

Input/Output

turn corrections on, which DOES initiate a sweep.

Key Path	Input/Output, Corrections
Remote Command	[:SENSe] :CORRection:CSET [1] 2 3 4 5 6 [:STATe] ON OFF 1 0 [:SENSe] :CORRection:CSET [1] 2 3 4 5 6 [:STATe] ?
Example	SENS:CORR:CSET1 ON
Dependencies	Turning this on automatically turns on "Apply Corrections" Only the first correction array (Correction 1) supports antenna units. When this array is turned on, and it contains an Antenna Unit other than "None", the Y Axis Unit of the analyzer is forced to that Antenna Unit. All other Y Axis Unit choices are grayed out. Note that this means that a correction file with an Antenna Unit can only be loaded into the Corrections 1 register. Consequently only for Correction 1 does the dropdown in the Recall dialog include.ant, and if an attempt is made to load a correction file into any other Correction register which DOES contain an antenna unit, a Mass Storage error is generated. This command will generate an "Option not available" error unless you have the proper option installed in your instrument.
Preset	Not affected by a Preset. Set to OFF by Restore Input/Output Defaults
State Saved	Saved in instrument state.
Initial S/W Revision	A.02.00

Properties

Accesses a menu that lets you set the properties of the selected correction.

Key Path	Input/Output, Corrections
Initial S/W Revision	A.02.00

Select Correction

Specifies the selected correction. The term "selected correction" is used throughout this document to specify which correction will be affected by the functions.

Key Path	Input/Output, Corrections, Properties
Notes	The selected correction is remembered even when not in the correction menu.
Preset	Set to Correction 1 by Restore Input/Output Defaults.
Readback	Correction 1 Correction 2 Correction 3 Correction 4 Correction 5 Correction 6
Initial S/W Revision	A.02.00

Antenna Unit

For devices (like antennae) which make measurements of field strength or flux density, the correction array should contain within its values the appropriate conversion factors such that, when the data on the analyzer is presented in dB μ V, the display is calibrated in the appropriate units. The "Antenna Unit" used for the conversion is contained within the corrections array database. It may be specified by the user or loaded in from an external file or SCPI.

When an array with an Antenna Unit other than "None" is turned on, the Y Axis Unit of the analyzer is forced to that unit. When this array is turned on, and it contains an Antenna Unit other than "None", the Y Axis Unit of the analyzer is forced to that Antenna Unit., and all other Y Axis Unit choices are grayed out.

Antenna Unit does not appear in all Modes that support Corrections. Only the modes listed in the Mode row of the table below support Antenna Units.

Key Path	Input/Output, Corrections, Properties
Mode	SA
Remote Command	[:SENSe] :CORRection:CSET [1] 2 3 4 :ANTenna [:UNIT] GAUSS PTES1a UVM UAM NOConversion [:SENSe] :CORRection:CSET [1] 2 3 4 :ANTenna [:UNIT] ?
Example	CORR:CSET:ANT GAUS
Dependencies	Only the first correction array (Correction 1) supports antenna units. Note that this means that a correction file with an Antenna Unit can only be loaded into the Corrections 1 register. Consequently only for Correction 1 does the dropdown in the Recall dialog include.ant, and if an attempt is made to load a correction file into any other Correction register which DOES contain an antenna unit, a Mass Storage error is generated.
Preset	Unaffected by Preset. Set to NOC by Restore Input/Output Defaults
State Saved	Saved in State
Initial S/W Revision	A.02.00

dB μ V/m

Sets the antenna unit to dB μ V/m. If this correction is turned on, and Apply Corrections is on, the Y Axis Unit will then be forced to dB μ V/m and all other Y Axis Unit selections will be grayed out.

Key Path	Input/Output, Corrections, Properties, Antenna Unit
Example	:CORR:CSET2:ANT UVM
Readback	"dB μ V/m"
Initial S/W Revision	A.02.00

dB μ A/m

Sets the antenna unit to dB μ A/m. If this correction is turned on, and Apply Corrections is on, the Y Axis Unit will

Input/Output

then be forced to dB μ A/m and all other Y Axis Unit selections will be grayed out.

Key Path	Input/Output, Corrections, Properties, Antenna Unit
Example	:CORR:CSET2:ANT UVA
Readback	" dB μ A/m"
Initial S/W Revision	A.02.00

dBpT

Sets the antenna unit to dBpT. If this correction is turned on, and Apply Corrections is on, the Y Axis Unit will then be forced to dBpT and all other Y Axis Unit selections will be grayed out.

Key Path	Input/Output, Corrections, Properties, Antenna Unit
Example	:CORR:CSET3:ANT PTES
Readback	"dBpT"
Initial S/W Revision	A.02.00

dBG

Sets the antenna unit to dBG. If this correction is turned on, and Apply Corrections is on, the Y Axis Unit will then be forced to dBG and all other Y Axis Unit selections will be grayed out.

Key Path	Input/Output, Corrections, Properties, Antenna Unit
Example	:CORR:CSET:ANT GAUS
Readback	" dBG"
Initial S/W Revision	A.02.00

None

Selects no antenna unit for this Correction set. Thus no Y Axis unit will be forced.

Key Path	Input/Output, Corrections, Properties, Antenna Unit
Example	:CORR:CSET4:ANT NOC
Readback	"None"
Initial S/W Revision	A.02.00

Frequency Interpolation

This setting controls how the correction values per-bucket are calculated. We interpolate between frequencies in either the logarithmic or linear scale.

This setting is handled and stored individually per correction set.

See “Interpolation” on page 1015

Key Path	Input/Output, Corrections, Properties
Remote Command	[:SENSE] :CORRection:CSET [1] 2 3 4 5 6 :X:SPACing LINear LOGarithmic [:SENSe] :CORRection:CSET [1] 2 3 4 5 6 :X:SPACing?
Example	CORR:CSET:X:SPAC LIN
Preset	Unaffected by a Preset. Set to Linear by Restore Input/Output Defaults.
State Saved	Saved in instrument state.
Initial S/W Revision	A.02.00

Interpolation

For each bucket processed by the application, all of the correction factors at the frequency of interest (center frequency of each bucket) are summed and added to the amplitude. All trace operations and post processing treat this post-summation value as the true signal to use.

To effect this correction, the goal, for any particular start and stop frequency, is to build a correction trace, whose number of points matches the current Sweep Points setting of the instrument, which will be used to apply corrections on a bucket by bucket basis to the data traces.

For amplitudes that lie between two user specified frequency points, we interpolate to determine the amplitude value. You may select either linear or logarithmic interpolation between the frequencies.

If we interpolate on a log scale, we assume that the line between the two points is a straight line on the log scale. For example, let’s say the two points are (2,4) and (20,1). A straight line between them on a log scale looks like:

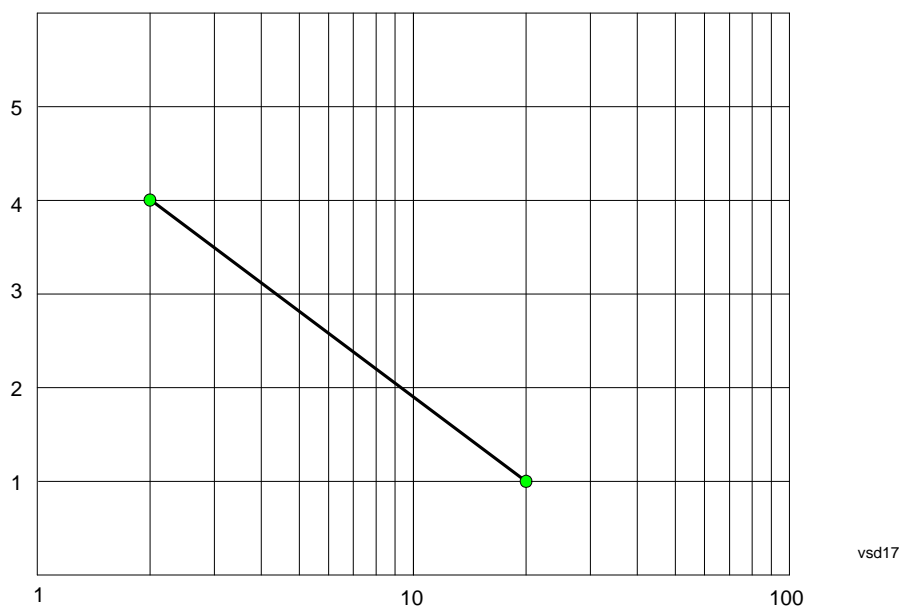

On a linear scale (like that of the spectrum analyzer), this translates to:

Input/Output

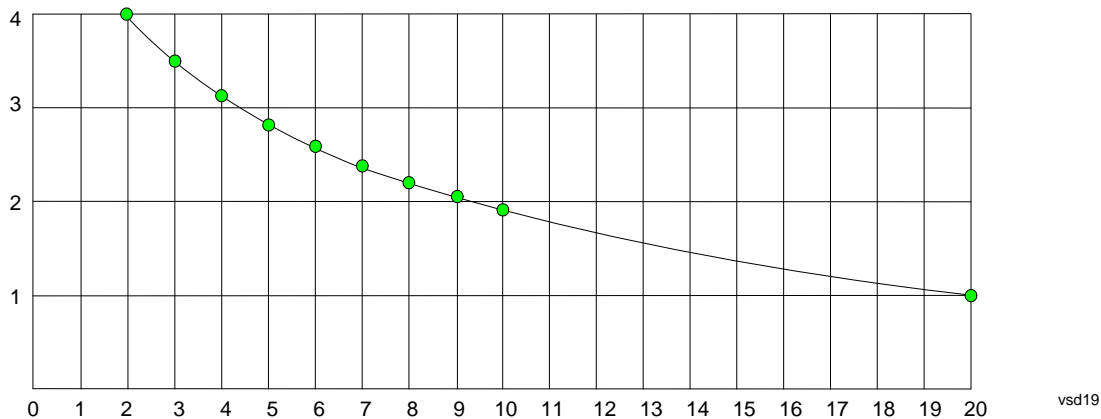

On the other hand, if we interpolate on a linear scale, we assume that the two points are connected by a straight line on the linear scale, as below:

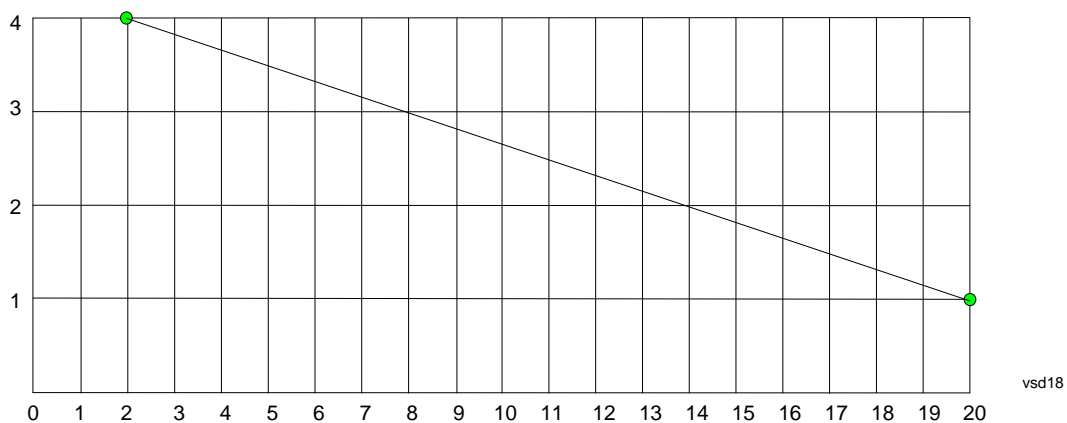

The correction to be used for each bucket is taken from the interpolated correction curve at the center of the bucket.

Description

Sets an ASCII description field which will be stored in an exported file. Can be displayed in the active function area by selecting as the active function, if desired to be in a screen dump.

Key Path	Input/Output, Corrections, Properties
Remote Command	[:SENSe]:CORRection:CSET [1] 2 3 4 5 6:DESCRiption "text" [:SENSe]:CORRection:CSET [1] 2 3 4 5 6:DESCRiption?
Example	:CORR:CSET1:DESC "11941A Antenna correction"
Notes	45 chars max; may not fit on display if max chars used
Preset	Unaffected by a Preset. Set to empty by Restore Input/Output Defaults
State Saved	Saved in instrument state.
Initial S/W Revision	A.02.00

Comment

Sets an ASCII comment field which will be stored in an exported file. Can be displayed in the active function area by selecting as the active function, if desired to be in a screen dump.

Key Path	Input/Output, Corrections, Properties
Remote Command	[:SENSe] :CORRection:CSET [1] 2 3 4 5 6 :COMMeNt "text" [:SENSe] :CORRection:CSET [1] 2 3 4 5 6 :COMMeNt?
Example	:CORR:CSET1:COMM "this is a comment"
Notes	45 chars max; may not fit on display if max chars used
Preset	Unaffected by Preset. Set to empty by Restore Input/Output Defaults
State Saved	Saved in instrument state
Initial S/W Revision	A.02.00

Edit

Invokes the integrated editing facility for this correction set.

When entering the menu, the editor window turns on, the selected correction is turned **On**, **Apply Corrections** is set to **On**, the amplitude scale is set to **Log**, and the Amplitude Correction (“Ampcor”) trace is displayed. The actual, interpolated correction trace is shown in green for the selected correction. Note that since the actual interpolated correction is shown, the correction trace may have some curvature to it. This trace represents only the correction currently being edited, rather than the total, accumulated amplitude correction for all amplitude corrections which are currently on, although the total, accumulated correction for all corrections which are turned on is still applied to the data traces.

Because corrections data is always in dB, but the Y-axis of the analyzer is in absolute units, it is necessary to establish a reference line for display of the Corrections data. The reference line is halfway up the display and represents 0 dB of correction. It is labeled “0 dB CORREC”. It is drawn in blue.

Corrections data is always in dB. Whatever dB value appears in the correction table represents the correction to be applied to that trace at that frequency. So if a table entry shows 30 dB that means we ADD 30 dB to each trace to correct it before displaying it. By definition all points are connected. If a gap is desired for corrections data, enter 0 dB.

Note that a well-designed Corrections array should start at 0 dB and end at 0 dB. This is because whatever the high end point is will be extended to the top frequency of the instrument, and whatever the low end point is will be extended down to 0 Hz. So for a Corrections array to have no effect outside its range, you should start and end the array at 0 dB.

NOTE The table editor will only operate properly if the analyzer is sweeping, because its updates are tied to the sweep system. Thus, you should not try to use the editor in single sweep, and it will be sluggish during compute-intensive operations like narrow-span FFT sweeps.

When exiting the edit menu (by using the **Return** key or by pressing an instrument front-panel key), the editor window turns off and the Ampcor trace is no longer displayed; however, **Apply Corrections**

Input/Output

remains **On**, any correction that was on while in the editor remains on, and the amplitude scale returns to its previous setting.

Corrections arrays are not affected by a Preset, because they are in the Input/Output system. They also survive shutdown and restarting of the analyzer application, which means they will survive a power cycle.

Key Path	Input/Output, Corrections
Initial S/W Revision	A.02.00

Navigate

Lets you move through the table to edit the desired point.

Key Path	Input/Output, Corrections, Edit
Notes	There is no value readback on the key
Min	1
Max	2000
Initial S/W Revision	A.02.00

Frequency

Lets you edit the frequency of the current row.

Key Path	Input/Output, Corrections, Edit
Notes	There is no value readback on the key.
Min	0
Max	1 THz
Initial S/W Revision	A.02.00

Amplitude

Lets you edit the Amplitude of the current row.

Key Path	Input/Output, Corrections, Edit
Notes	There is no value readback on the key.
Min	-1000 dB
Max	1000 dB
Initial S/W Revision	A.02.00

Insert Point Below

Inserts a point below the current point. The new point is a copy of the current point and becomes the

current point. The new point is not yet entered into the underlying table, and the data in the row is displayed in light gray.

Key Path	Input/Output, Corrections, Edit
Initial S/W Revision	A.02.00

Delete Point

Deletes the currently-selected point, whether or not that point is being edited, and selects the Navigate functionality. The point following the currently-selected point (or the point preceding if there is none) will be selected.

Key Path	Input/Output, Corrections, Edit
Initial S/W Revision	A.02.00

Scale X Axis

Matches the X Axis to the selected Correction, as well as possible. Sets the Start and Stop Frequency to contain the minimum and maximum Frequency of the selected Correction. The range between Start Frequency and Stop Frequency is 12.5% above the range between the minimum and maximum Frequency, so that span exceeds this range by one graticule division on either side. If in zero-span, or there is no data in the Ampcor table, or the frequency range represented by the table is zero, no action is taken. Standard clipping rules apply if the value in the table is outside the allowable range for the X axis.

Key Path	Input/Output, Corrections, Edit
Initial S/W Revision	A.02.00

Delete Correction

Deletes the correction values for this set. When this key is pressed a prompt is placed on the screen that says "Please press Enter or OK key to delete correction. Press ESC or Cancel to close this dialog." The deletion is only performed if you press OK or Enter; if so, after the deletion, the informational message "Correction deleted" appears in the MSG line.

Key Path	Input/Output, Corrections
Remote Command	[:SENSE] :CORRection:CSET [1] 2 3 4 5 6 :DELeTe
Example	CORR:CSET:DEL CORR:CSET1:DEL CORR:CSET4:DEL
Notes	Pressing this key when no corrections are present is accepted without error.
Initial S/W Revision	A.02.00

Apply Corrections

Applies amplitude corrections which are marked as ON to the measured data. If this is set to OFF, then

Input/Output

no amplitude correction sets will be used, regardless of their individual on/off settings. If set to ON, the corrections that are marked as ON (see “Correction On/Off” on page 1011) are used.

Key Path	Input/Output, Corrections
Remote Command	[:SENSe] :CORRection:CSET:ALL [:STATe] ON OFF 1 0 [:SENSe] :CORRection:CSET:ALL [:STATe] ?
Example	SENS:CORR:CSET:ALL OFF This command makes sure that no amplitude corrections are applied, regardless of their individual on/off settings.
Preset	Not affected by Preset. Set to OFF by Restore Input/Output Defaults
State Saved	Saved in instrument state.
Initial S/W Revision	A.02.00

Delete All Corrections

Erases all correction values for all 4 Amplitude Correction sets.

When this key is pressed a prompt is placed on the screen that says “Please press Enter or OK key to delete all corrections. Press ESC or Cancel to close this dialog.” The deletion is only performed if you press OK or Enter; if so, after the deletion, the informational message “All Corrections deleted” appears in the MSG line.

Key Path	Input/Output, Corrections
Remote Command	[:SENSe] :CORRection:CSET:ALL:DELeTe
Example	CORR:CSET:ALL:DEL
Initial S/W Revision	A.02.00

Set (Replace) Data (Remote Command Only)

The command takes an ASCII series of alternating frequency and amplitude points, each value separated by commas.

The values sent in the command will totally replace all existing correction points in the specified set.

An Ampcor array can contain 2000 points maximum.

Remote Command	[:SENSe] :CORRection:CSET [1] 2 3 4 5 6 :DATA <freq> , <ampl> , . . . [:SENSe] :CORRection:CSET [1] 2 3 4 5 6 :DATA ?
Example	CORR:CSET1:DATA 10000000,-1.0,20000000,1.0 This defines two correction points at (10 MHz, -1.0 dB) and (20 MHz, 1.0 dB) for correction set 1.

Preset	Empty after Restore Input/Output Defaults. Survives a shutdown or restart of analyzer application (including a power cycle).
State Saved	Saved in instrument state.
Min	Freq: 0 Hz Amptd: -1000 dBm
Max	Freq: 1 THz Amptd: +1000 dBm
Initial S/W Revision	A.02.00

Merge Correction Data (Remote Command Only)

The command takes an ASCII series of alternating frequency and amplitude points, each value separated by commas. The difference between this command and Set Data is that this merges new correction points into an existing set.

Any new point with the same frequency as an existing correction point will replace the existing point's amplitude with that of the new point.

An Ampcor array can contain 2000 total points, maximum.

Remote Command	<code>[:SENSE] :CORRection:CSET [1] 2 3 4 5 6 :DATA:MERGe <freq>, <ampl>, ...</code>
Example	<code>CORR:CSET1:DATA:MERGE 15000000,-5.0,25000000,5.0</code> This adds two correction points at (15 MHz, -5.0 dB) and (25 MHz, 5.0 dB) to whatever values already exist in correction set 1.
Preset	Empty after Restore Input/Output Defaults. Survives shutdown/restart of analyzer application (including power cycle)
Min	Freq: 0 Hz Amptd: -1000 dBm
Max	Freq: 1 THz Amptd: +1000 dBm
Initial S/W Revision	A.02.00

Freq Ref In

Specifies the frequency reference as being the internal reference, external reference or sensing the presence of an external reference.

When the frequency reference is set to internal, the internal 10 MHz reference is used even if an external reference is connected.

When the frequency reference is set to external, the instrument will use the external reference. However, if there is no external signal present, or it is not within the proper amplitude range, an error condition detected message is generated. When the external signal becomes valid, the error is cleared.

Input/Output

If Sense is selected, the instrument checks whether a signal is present at the external reference connector and will automatically switch to the external reference when a signal is detected. When no signal is present, it automatically switches to the internal reference. No message is generated as the reference switches between external and internal. The monitoring of the external reference occurs approximately on 1 millisecond intervals, and never occurs in the middle of a measurement acquisition, only at the end of the measurement (end of the request).

If for any reason the instrument's frequency reference is not able to obtain lock, Status bit 2 in the Questionable Frequency register will be true and an error condition detected message is generated. When lock is regained, Status bit 2 in the Questionable Frequency register will be cleared and an error message is cleared will be sent.

If an external frequency reference is being used, you must enter the frequency of the external reference if it is not exactly 10 MHz. The External Ref Freq key is provided for this purpose.

Key Path	Input/Output
Remote Command	[:SENSe] :ROSCillator :SOURce :TYPE INTernal EXTernal SENSe [:SENSe] :ROSCillator :SOURce :TYPE?
Preset	This is unaffected by a Preset but is set to SENSe on a "Restore Input/Output Defaults" or "Restore System Defaults->All".
State Saved	Saved in instrument state.
Status Bits/OPC dependencies	STATus:QUEStionable:FREQuency bit 2 set if unlocked.
Initial S/W Revision	Prior to A.02.00

Remote Command	[:SENSe] :ROSCillator :SOURce?
Notes	The query [SENSe]:ROSCillator:SOURce? returns the current switch setting. This means: <ol style="list-style-type: none"> 1. If it was set to SENSe but there is no external reference so the instrument is actually using the internal reference, then this query returns INTernal and not SENSe. 2. If it was set to SENSe and there is an external reference present, the query returns EXTernal and not SENSe. 3. If it was set to EXTernal, then the query returns "EXTernal" 4. If it was set to INTernal, then the query returns INTernal
Preset	SENSe
Backwards Compatibility SCPI	The query [:SENSe]:ROSCillator:SOURce? was a query-only command in ESA which always returned whichever reference the instrument was using. The instrument automatically switched to the ext ref if it was present. In PSA (which had no sensing) the command [:SENSe]:ROSCillator:SOURce set the reference (INT or EXT), so again its query returned the actual routing. Thus the query form of this command is 100% backwards compatible with both instruments.

Initial S/W Revision	Prior to A.02.00
Remote Command	[:SENSE] :ROSCillator:SOURce INTernal EXTernal
Notes	([:SENSe]:ROSCillator:SOURce:TYPE INTernal EXTernal and directly sets the routing to either internal or external.)
Initial S/W Revision	Prior to A.02.00

Sense

The external reference is used if a valid signal is sensed at the Ext Ref input. Otherwise the internal reference is used.

Key Path	Input/Output, Freq Ref In
Example	:ROSC:SOUR:TYPE SENS
Readback	Sense
Initial S/W Revision	Prior to A.02.00

Internal

The internal reference is used.

Key Path	Input/Output, Freq Ref In
Example	:ROSC:SOUR:TYPE INT
Readback	Internal
Initial S/W Revision	Prior to A.02.00

External

The external reference is used.

Key Path	Input/Output, Freq Ref In
Example	:ROSC:SOUR:TYPE EXT
Readback	External
Initial S/W Revision	Prior to A.02.00

Ext Ref Freq

This key tells the analyzer the frequency of the external reference. When the external reference is in use (either because the reference has been switched to External or because the Reference has been switched to Sense and there is a valid external reference present) this information is used by the analyzer to determine the internal settings needed to lock to that particular external reference signal.

For the instrument to stay locked, the value entered must be within 5 ppm of the actual external reference

Input/Output

frequency. So it is important to get it close, or you risk an unlock condition.

Note that this value only affects the instrument's ability to lock. It does not affect any calculations or measurement results. See "Freq Offset" in the Frequency section for information on how to offset frequency values.

Key Path	Input/Output, Freq Ref In
Remote Command	[:SENSe] :ROSCillator :EXTernal :FREQuency <freq> [:SENSe] :ROSCillator :EXTernal :FREQuency?
Example	ROSC:EXT:FREQ 20 MHz sets the external reference frequency to 20 MHz, but does not select the external reference. ROSC:SOUR:TYPE EXT selects the external reference.
Notes	Still available with Internal selected, to allow setup for when External is in use.
Preset	This is unaffected by a Preset but is set to 10 MHz on a "Restore Input/Output Defaults" or "Restore System Defaults->All"
Min	CXA: 10 MHz EXA: 10 MHz MXA: 1 MHz PXA: 1 MHz
Max	CXA: 10 MHz EXA: 10 MHz MXA: 50 MHz PXA: 50 MHz
Initial S/W Revision	Prior to A.02.00
Default Unit	Hz

External Reference Lock BW

This control lets you adjust the External Reference phase lock bandwidth. This control is available in some models of the X-Series.

The PXA variable reference loop bandwidth allows an external reference to be used and have the analyzer close-in phase noise improved to match that of the reference. This could result in an improvement of tens of decibels. The choice of "Wide" or "Narrow" affects the phase noise at low offset frequencies, especially 4 to 400 Hz offset. When using an external reference with superior phase noise, we recommend setting the external reference phase-locked-loop bandwidth to wide (60 Hz), to take advantage of that superior performance. When using an external reference with inferior phase noise performance, we recommend setting that bandwidth to narrow (15 Hz). In these relationships, inferior and superior phase noise are with respect to 134 dBc/Hz at 30 Hz offset from a 10 MHz reference. Because most reference sources have phase noise behavior that falls off at a rate of 30 dB/decade, this is

usually equivalent to 120 dBc/Hz at 10 Hz offset.

Key Path	Input/Output, Freq Ref In
Scope	Mode Global
Remote Command	[:SENSe] :ROSCillator: BANDwidth WIDE NARRow [:SENSe] :ROSCillator: BANDwidth?
Example	ROSC: BAND WIDE
Dependencies	This key only appears in analyzers equipped with the required hardware.
Preset	This is unaffected by a Preset but is set to Narrow on a "Restore Input/Output Defaults" or "Restore System Defaults -> All"
State Saved	Saved in Input/Output state.
Initial S/W Revision	A.04.00

External Ref Coupling

Only appears with option ERC installed and licensed.

This function lets you couple the sweep system of the analyzer to the state of the External Reference. If **Normal** is selected, data acquisition proceeds regardless of the state of the External Reference. When you select **Ext Ref Out Of Range Stops Acquisition**, the data acquisition (sweep or measurement) stops when either the "521, External ref out of range" or the "503, Frequency Reference unlocked" error is asserted. Note that this will only take place if the **Freq Ref In** selection is **External**.

With the acquisition stopped, the data display will stop updating (even if this occurs in the middle of a sweep or measurement) and no data will be returned to a READ? or MEASure? query; that is, these queries will not complete because the analyzer will not respond to them. Furthermore, no response will be generated to a *WAI? or *OPC? query.

Proper SCPI sequences are shown below, which will always fail to return if the acquisition stops during the requested sweep or measurement. Note that, for predictable operation of this function, it is best to operate the analyzer in single measurement mode (INIT:CONT OFF), because if operating in continuous mode, the analyzer may respond to the above queries even after the acquisition stops, with data left over from the previous acquisition.

```
:INIT:CONT OFF
```

```
:INIT:IMM;*OPC?
```

```
--
```

```
:INIT:CONT OFF
```

```
:INIT:IMM;*WAI?
```

```
--
```

```
:INIT:CONT OFF
```

```
:READ?
```

Input/Output

--

:INIT:CONT OFF

:MEASure?

When the acquisition ceases, in addition to the error condition(s) described above, an error message will be generated informing you that the acquisition has ceased due to an invalid external reference. This message will stay on the screen while the acquisition is suspended.

External reference problem.
Data acquisition suspended.
To resume data acquisition, fix the
problem and press the Restart key
OR
Press the following keys:
Input/Output, More 1 of 2, Freq Ref In,
External Ref Coupling, Normal
OR
Input/Output, More 1 of 2,
Freq Ref In, Internal

If you press the Restart key this message will be taken off the screen and a new acquisition will be attempted; if the External Reference problem persists the message will go right back up. You can also take the message down by changing back to the **Normal** setting of Sweep/Ext Ref Coupling, or by pressing **Freq Ref In, Internal**, or **Freq Ref In, Sense**, or **Restore Input/Output Defaults**.

The setting of **External Ref Coupling** is persistent across power-cycling and is not reset with a Preset. It is reset to the default state (**Normal**) when **Restore Input/Output Defaults** is invoked, which will also restart normal data acquisition.

The detection of invalid external reference is under interrupt processing. If the external reference becomes invalid then returns to valid in too short a time, no error condition will be detected or reported and therefore the acquisition will not be stopped.

Key Path	Input/Output, Freq Ref In
Mode	All
Remote Command	[[:SENSE]:ROSCillator:COUpling NORMAL NACquisition [:SENSE]:ROSCillator:COUpling?
Preset	This setting is persistent: it survives power-cycling or a Preset and is reset with Restore Input/Output defaults.
State Saved	Not saved in instrument state
Readback	Normal Stop Acq
Initial S/W Revision	A.02.00

Output Config

Accesses keys that configure various output settings, like the frequency reference output, trigger output and analog output.

Key Path	Input/Output
Initial S/W Revision	Prior to A.02.00

Trig Out (1 and 2)

Select the type of output signal that will be output from the rear panel Trig 1 Out or Trig 2 Out connectors.

Key Path	Input/Output, Output Config
Remote Command	:TRIGger TRIGger1 TRIGger2[:SEquence]:OUTPut HSWP MEASuring MAIN GATE GTRigger OEVEN SPOint SSweep S SETtled S1Marker S2Marker S3Marker S4Marker OFF :TRIGger TRIGger1 TRIGger2[:SEquence]:OUTPut?
Example	TRIG:OUTP HSWP TRIG2:OUTP GATE
Dependencies	The second Trigger output (Trig 2 Out) does not appear in all models; in models that do not support it, the Trig 2 Out key is blanked, and sending the SCPI command for this output generates an error, "Hardware missing; Not available for this model number" In models that do not support the Trigger 2 output, this error is returned if trying to set Trig 2 Out and a query of Trig 2 Out returns OFF.
Preset	Trigger 1: Sweeping (HSWP) Trigger 2: Gate This is unaffected by a Preset but is preset to the above values on a "Restore Input/Output Defaults" or "Restore System Defaults->All"
State Saved	Saved in instrument state
Initial S/W Revision	Prior to A.02.00

Polarity

Sets the output to the Trig 1 Out or Trig 2 Out connector to trigger on either the positive or negative polarity.

Key Path	Input/Output, Output Config, Trig 1/2 Output
Remote Command	:TRIGger TRIGger1 TRIGger2[:SEquence]:OUTPut:POLarity POSitive NEGative :TRIGger TRIGger1 TRIGger2[:SEquence]:OUTPut:POLarity?
Example	TRIG1:OUTP:POL POS

Input/Output

Preset	This is unaffected by a Preset but is set to POSitive on a "Restore Input/Output Defaults" or "Restore System Defaults->All"
State Saved	Saved in instrument state
Initial S/W Revision	Prior to A.02.00

Sweeping (HSWP)

Selects the Sweeping Trigger signal to be output to the Trig 1 Out or Trig 2 Out connector when a measurement is made. This signal has historically been known as "HSWP" (High = Sweeping), and is 5 V TTL level with 50 ohm output impedance."

Key Path	Input/Output, Output Config, Trig 1/2 Output
Example	TRIG1:OUTP HSWP
Readback	Sweeping
Initial S/W Revision	Prior to A.02.00

Measuring

Selects the Measuring trigger signal to be output to the Trig 1 Out or Trig 2 Out connector. This signal is true while the Measuring status bit is true.

Key Path	Input/Output, Output Config, Trig 1/2 Output
Example	TRIG1:OUTP MEAS
Readback	Measuring
Initial S/W Revision	Prior to A.02.00

Main Trigger

Selects the current instrument trigger signal to be output to the Trig 1 Out or Trig 2 Out connector.

Key Path	Input/Output, Output Config, Trig 1/2 Output
Example	TRIG1:OUTP MAIN
Readback	Main Trigger
Initial S/W Revision	Prior to A.02.00

Gate Trigger

Selects the gate trigger signal to be output to the Trig 1 Out or Trig 2 Out connector. This is the source of the gate timing, not the actual gate signal.

Key Path	Input/Output, Output Config, Trig 1/2 Output
Example	TRIG1:OUTP GTR

Readback	Gate Trigger
Initial S/W Revision	Prior to A.02.00

Gate

Selects the gate signal to be output to the Trig 1 Out or Trig 2 Out connector. The gate signal has been delayed and its length determined by delay and length settings. When the polarity is positive, a high on the Trig 1 Out or Trig 2 Out represents the time the gate is configured to pass the signal.

Key Path	Input/Output, Output Config, Trig 1/2 Output
Example	TRIG1:OUTP GATE
Readback	Gate
Initial S/W Revision	Prior to A.02.00

Odd/Even Trace Point

Selects either the odd or even trace points as the signal to be output to the Trig 1 Out or Trig 2 Out connector when performing swept spectrum analysis. When the polarity is positive, this output goes high during the time the analyzer is sweeping past the first point (Point 0) and every other following trace point. The opposite is true if the polarity is negative.

Key Path	Input/Output, Output Config, Trig 1/2 Output
Example	TRIG1:OUTP OEV
Readback	Odd/Even
Initial S/W Revision	Prior to A.02.00

Off

Selects no signal to be output to the Trig 1 Out or Trig 2 Out connector.

Key Path	Input/Output, Output Config, Trig 1/2 Output
Example	TRIG1:OUTP OFF
Readback	Off
Initial S/W Revision	Prior to A.02.00

Analog Out

This menu lets you control which signal is fed to the “Analog Out” connector on the analyzer rear panel.

See [“More Information” on page 1030](#)

Key Path	Input/Output, Output Config
----------	------------------------------------

Input/Output

Remote Command	:OUTPut:ANALog OFF SVIDeo LOGVideO LINVideO DAUDio :OUTPut:ANALog?
Example	OUTP:ANAL SVIDeo ! causes the analog output type to be Screen Video
Preset	OFF
Preset	This is unaffected by Preset but is set to DAUDio on a "Restore Input/Output Defaults" or "Restore System Defaults->All
State Saved	Saved in Input/Output State
Readback line	1-of-N selection [variable]
Backwards Compatibility Notes	Prior to A.04.00, OFF was the default functionality except when in the Analog Demod application or with Tune and Listen, in which case it was DAUDio, and there was no selection menu. So for backwards compatibility, Auto (:OUTP:ANAL:AUTO ON) will duplicate the prior behavior. The DNWB and SANalyzer parameters, which were legal in PSA but perform no function in the X-Series, are accepted without error.
Initial S/W Revision	A.04.00

More Information

The table below gives the range for each output.

Analog Out	Nominal Range exc. (10% overrange)	Scale Factor	Notes
Off	0 V		
Screen Video	0 – 1 V open circuit	10%/division	8566 compatible
Log Video	0 – 1 V terminated	1/(192.66 dB/V)	dB referenced to mixer level, 1V out for –10 dBm at the mixer.
Linear Video	0 – 1 V terminated	100%/V	Linear referenced to Ref Level, 1 V out for RF envelope at the Ref Level.
Demod Audio	(varies with analyzer setting)		

Auto

Selects the Auto state for the Analog Output menu. In this state, the Analog Output will automatically be set to the most sensible setting for the current mode or measurement.

If you make a selection manually from the Analog Out menu, this selection will remain in force until you change it (or re-select Auto), even if you go to a mode or measurement for which the selected output does not apply.

Key Path	Input/Output, Output Config, Analog Out
----------	--

Remote Command	OUTPut :ANALog :AUTO OFF ON 0 1 OUTPut :ANALog :AUTO?
Example	OUTP:ANAL:AUTO ON
Preset	ON
State Saved	Saved in Input/Output State
Initial S/W Revision	A.04.00

Off

Turns off the analog output.

Key Path	Input/Output, Output Config, Analog Out
Example	OUTP:ANAL OFF ! causes the analog output to be off
Readback Text	Off
Initial S/W Revision	A.04.00

Screen Video

Selects the analog output to be the screen video signal. In this mode, the pre-detector data is output to the Analog Out connector. The output looks very much like the trace displayed on the analyzer's screen, and depends on the Log/Lin display Scale, Reference Level, and dB per division, but is not influenced by the selected detector or any digital flatness corrections or trace post-processing (like Trace Averaging).

Note that this mode is similar to the Analog Output of the HP 8566 family and the Video Out (opt 124) capability of the Agilent PSA analyzer (E444x), although there are differences in the behavior.

See [“Backwards Compatibility:” on page 1032](#).

Key Path	Input/Output, Output Config, Analog Out
Example	OUTP:ANAL SVID
Dependencies	<p>Because the Screen Video output uses one of the two IF processing channels, only one detector is available while Screen Video is selected. All active traces will change to use the same detector as the selected trace when Screen Video is activated.</p> <p>Screen Video output is not available while any EMI Detector is selected (Quasi Peak, RMS Average or EMI Average), because these detectors use both IF processing channels. Consequently, if the user chooses an EMI Detector, there will be no Screen Video output.</p> <p>The output holds at its last value during an alignment and during a marker count and during retrace (after a sweep and before the next sweep starts).</p> <p>This function depends on optional capability; the key will be blanked and the command will generate an “Option not available” error unless you have Option YAV or YAS licensed in your instrument.</p>

Input/Output

Couplings	Screen Video output changes while in FFT Sweeps, so for measurements that use exclusively FFT Sweeps, or if the user manually chooses FFT Sweeps, the Screen Video output will look different than it does in swept mode.
Readback Text	Screen Video
Initial S/W Revision	A.04.00

Backwards Compatibility:

The Screen Video function is intended to be very similar to the 8566 Video Output and the PSA Option 124. However, unlike the PSA, it is not always on; it must be switched on by the Screen Video key. Also, unlike the PSA, there are certain dependencies (detailed above) – for example, the Quasi Peak Detector is unavailable when Screen Video is on.

Futhermore, the PSA Option 124 hardware was unipolar and its large range was padded to be exactly right for use as a Screen Video output. In the X-Series, the hardware is bipolar and has a wider range to accommodate the other output choices. Therefore, the outputs won't match up exactly and users may have to modify their setup when applying the X-Series in a PSA application.

Log Video (RF Envelope, Ref=Mixer Level)

Selects the analog output to be the log of the video signal. In this mode, the pre-detector data is output to the Analog Out connector with a Log scaling. The output is referenced to the current level at the mixer, does not depend on display settings like Reference Level or dB per division, and it is not influenced by the selected detector or any digital flatness corrections or trace post-processing (like Trace Averaging), but does change with input attenuation.

The output is designed so that full scale (1 V) corresponds to –10 dBm at the mixer. The full range (0–1 V) covers 192.66 dB ; thus, 0 V corresponds to –202.66 dBm at the mixer.

Key Path	Input/Output, Output Config, Analog Out
Example	OUTP:ANAL LOGV
Dependencies	<p>Because the Log Video output uses one of the two IF processing channels, only one detector is available while Screen Video is selected. All active traces will change to use the same detector as the selected trace when Log Video is activated.</p> <p>Log Video output is not available while any EMI Detector is selected (Quasi Peak, RMS Average or EMI Average), because these detectors use both IF processing channels. Consequently, if the user chooses an EMI Detector, there will be no Log Video output.</p> <p>The output holds at its last value during an alignment, during a marker count, and during retrace (after a sweep and before the next sweep starts).</p> <p>This function depends on optional capability. The key will be blanked and the command will generate an “Option not available” error unless you have Option YAV licensed in your instrument.</p>
Couplings	Log Video output changes while in FFT Sweeps, so for measurements that use exclusively FFT Sweeps, or if the user manually chooses FFT Sweeps, the Log Video output will look different than it does in swept mode.

Readback Text	Log Video
Initial S/W Revision	A.04.00

Linear Video (RF Envelope, Ref=Ref Level)

Selects the analog output to be the envelope signal on a linear (voltage) scale. In this mode, the pre-detector data is output to the Analog Out connector with a Linear scaling. The output is based on the current Reference Level, and is not influenced by the selected detector or any digital flatness corrections or trace post-processing (like Trace Averaging).

The scaling is set so that 1 V output occurs with an instantaneous video level equal to the reference level, and 0 V occurs at the bottom of the graticule. This scaling gives you the ability to control the gain without having another setup control for the key. But it requires you to control the look of the display (the reference level) in order to control the analog output.

This mode is ideal for looking at Amplitude Modulated signals, as the linear envelope effectively demodulates the signal.

Key Path	Input/Output, Output Config, Analog Out
Example	OUTP:ANAL LINV
Dependencies	<p>Because the Linear Video output uses one of the two IF processing channels, only one detector is available while Linear Video is selected. All active traces will change to use the same detector as the selected trace when Log Video is activated.</p> <p>Linear Video output is not available while any EMI Detector is selected (Quasi Peak, RMS Average or EMI Average), because these detectors use both IF processing channels. Consequently, if the user chooses an EMI Detector, there will be no Linear Video output.</p> <p>The output holds at its last value during an alignment and during a marker count and during retrace (after a sweep and before the next sweep starts).</p> <p>This function depends on optional capability; the key will be blanked and the command will generate an “Option not available” error unless you have Option YAV licensed in your instrument.</p>
Couplings	Linear Video output changes while in FFT Sweeps, so for measurements that use exclusively FFT Sweeps, or if the user manually chooses FFT Sweeps, the Linear Video output will look different than it does in swept mode.
Readback Text	Linear Video
Initial S/W Revision	A.04.00

Demod Audio

Selects the analog output to be the demodulation of the video signal.

When Demod Audio is selected, the demodulated audio signal appears at this output whenever the Analog Demod application is demodulating a signal or when **Analog Demod Tune and Listen** is operating in the Swept SA measurement.

Input/Output

When Analog Out is in the Auto state, this output is auto-selected when in the Analog Demod mode or when **Analog Demod Tune and Listen** is operating in the Swept SA measurement.

If any other Analog Output is manually selected when in the Analog Demod mode or when **Analog Demod Tune and Listen** is operating in the Swept SA measurement, a warning message appears in the status message bar.

Key Path	Input/Output, Output Config, Analog Out
Example	OUTP:ANAL DAUD
Dependencies	<p>This key only appears if the Analog Demod application (N9063A) or Option EMC is installed and licensed, otherwise the key will be blanked and the command will generate an “Option not available” error.</p> <p>The output holds at its last value during an alignment and during a marker count. It is not held between sweeps, in order for Tune and Listen to work properly.</p> <p>When Demod Audio is the selected Analog Output:</p> <ul style="list-style-type: none">• all active traces are forced to use the same detector.• CISPR detectors (QPD, EMI Avg, RMS Avg) are unavailable
Readback Text	Demod Audio
Initial S/W Revision	Prior to A.02.00 (this was the default functionality, and there was no selection)
Modified at S/W Revision	A.04.00

I/Q Cal Out

The Baseband I/Q "Cal Out" port can be turned on with either a 1 kHz or a 250 kHz square wave. This can be turned on independent of the input selection. A Preset will reset this to Off.

Key Path	Input/Output, Output Config
Remote Command	:OUTPut : IQ:OUTPut IQ1 IQ250 OFF :OUTPut : IQ:OUTPut?
Example	OUTP:IQ:OUTP IQ1
Couplings	An I/Q Cable Calibration or an I/Q Probe Calibration will change the state of the Cal Out port as needed by the calibration routine. When the calibration is finished the I/Q Cal Out is restored to the pre-calibration state.
Preset	Off
State Saved	Saved in instrument state.
Range	1 kHz Square Wave 250 kHz Square Wave Off
Readback Text	1 kHz 250 kHz Off
Initial S/W Revision	Prior to A.02.00

1 kHz Square Wave

Turns on the 1 kHz square wave signal at the Cal Out port. This choice is only available with option BBA.

Key Path	Input/Output, Output Config, I/Q Cal Out
Readback	I/Q 1kHz
Initial S/W Revision	Prior to A.02.00

250 kHz Square Wave

Turns on the 250 kHz square wave signal at the Cal Out port. This choice is only available with option BBA.

Key Path	Input/Output, Output Config, I/Q Cal Out
Readback	I/Q 250kHz
Initial S/W Revision	Prior to A.02.00

Off

Turns off the signal at the Cal Out port. This choice is only available with option BBA.

Key Path	Input/Output, Output Config, I/Q Cal Out
Readback	Off
Initial S/W Revision	Prior to A.02.00

Digital Bus (Narrowband)

This menu allows you to configure the LVDS connector located on the rear panel of the instrument. It is a unidirectional link of real time data at a 90 MSa/s rate. The ADC is sampling a 22.5 MHz IF.

The data that appears on this port is raw, uncorrected ADC samples, unless you have option RTL. With option RTL, you get fully corrected I/Q data.

This connector will only be active when the Narrowband IF Path is currently in use.

Key Path	Input/Output, Output Config, Digital Out
Initial S/W Revision	A.04.00

Bus Out On/Off

When Bus Out is on, all acquisitions are streamed to the output port including acquisitions for internal purposes such as Alignment; internal processing and routing of acquisitions continues as usual and is unaffected by the state of Bus Out.

Input/Output

When Bus Out is off, no signal appears on the LVDS port.

Key Path	Input/Output, Output Config, Digital Out, Digital Bus
Scope	Mode Global
Remote Command	:OUTPut:DBUS [1] [:STATe] ON OFF 1 0 :OUTPut:DBUS [1] [:STATe] ?
Example	OUTP:DBUS ON
Preset	This is unaffected by a Preset but is set to Off on a "Restore Input/Output Defaults" or "Restore System Defaults -> All"
State Saved	Saved in Input/Output State
Initial S/W Revision	Prior to A.02.00
Modified at S/W Revision	A.04.00

Aux IF Out

This menu controls the signals that appear on the SMA output on the rear panel labeled "AUX IF OUT":

Key Path	Input/Output, Output Config
Remote Command	:OUTPut:AUX SIF AIF LOGVideo OFF :OUTPut:AUX?
Preset	This is unaffected by a Preset but is set to OFF on a "Restore Input/Output Defaults" or "Restore System Defaults->All"
State Saved	Saved in Input/Output state
Readback line	1-of-N selection [variable]
Backwards Compatibility Notes	In the PSA, the IF output has functionality equivalent to the "Second IF" function in the X-Series' Aux IF Out menu. In the X-Series, it is necessary to switch the Aux IF Out to "Second IF" to get this functionality, whereas in PSA it is always on, since there are no other choices. Hence a command to switch this function to "Second IF" will have to be added by customers migrating from PSA who use the IF Output in PSA.
Initial S/W Revision	A.04.00

Second IF

In this mode the 2nd IF output is routed to the rear panel connector. The annotation on the key shows the current 2nd IF frequency in use in the analyzer.

The frequency of the 2nd IF depends on the current IF signal path as shown in the table below:

IF Path Selected	Frequency of “Second IF” Output
10 MHz	322.5 MHz
25 MHz	322.5 MHz
40 MHz	250 MHz
140 MHz	300 MHz

The signal quality, such as signal to noise ratio and phase noise, are excellent in this mode.

Key Path	Input/Output, Output Config, Aux IF Out
Example	OUTP:AUX SIF causes the aux output type to be Second IF
Readback Text	Second IF
Initial S/W Revision	A.04.00

Arbitrary IF

In this mode the 2nd IF output is mixed with a local oscillator and mixer to produce an arbitrary IF output between 10 MHz and 75 MHz with 500 kHz resolution. The phase noise in this mode will not be as good as in **Second IF** mode.

The IF output frequency is adjustable, through an active function which appears on the Arbitrary IF selection key, from 10 MHz to 75 MHz with 500 kHz resolution.

The bandwidth of this IF output varies with band and center frequency, but is about 40 MHz at the –3 dB width. When the output is centered at lower frequencies in its range, signal frequencies at the bottom of the bandwidth will “fold”. For example, with a 40 MHz bandwidth (20 MHz half-bandwidth), and a 15 MHz IF center, a signal –20 MHz relative to the spectrum analyzer center frequency will have a relative response of about –3 dB with a frequency 20 MHz below the 15 MHz IF center. This –5 MHz frequency will fold to become a +5 MHz signal at the IF output. Therefore, lower IF output frequencies are only useful with known band-limited signals.

Key Path	Input/Output, Output Config, Aux IF Out
Example	OUTP:AUX AIF causes the aux output type to be the Arbitrary IF
Readback Text	Arbitrary IF
Initial S/W Revision	A.04.00

Key Path	Input/Output, Output Config, Aux IF Out
Scope	Mode Global

Input/Output

Remote Command	:OUTPut:AUX:AIF <value> :OUTPut:AUX:AIF?
Example	:OUTP:AUX:AIF 50 MHZ
Preset	This is unaffected by a Preset but is set to 70 MHz on a "Restore Input/Output Defaults" or "Restore System Defaults->All"
State Saved	Saved in Input/Output State
Min	10 MHz
Max	75 MHz
Initial S/W Revision	A.04.00
Default Unit	Hz

Fast Log Video

In this mode the 2nd IF output is passed through a log amp and the log envelope of the IF signal is sent to the rear panel. The open circuit output level varies by about 25 mV per dB, with a top-of-screen signal producing about 1.6 Volts. The output impedance is nominally 50 ohms.

This mode is intended to meet the same needs as Option E4440A-H7L Fast Rise Time Video Output on the Agilent E4440A PSA Series, allowing you to characterize pulses with fast rise times using standard measurement suites on modern digital scopes.

Key Path	Input/Output, Output Config, Aux IF Out
Example	OUTP:AUX LOGVideo causes the aux output type to be Fast Log Video
Dependencies	The output is off during an alignment but not during a marker count, and is not blanked during retrace (after a sweep and before the next sweep starts).
Readback Text	Fast Log Video
Initial S/W Revision	A.04.00

Off

In this mode nothing comes out of the "AUX IF OUT" connector on the rear panel. The connector appears as an open-circuit (that is, it is not terminated in any way).

Key Path	Input/Output, Output Config, Aux IF Out
Example	OUTP:AUX OFF causes the aux output type to be off
Readback Text	Off
Initial S/W Revision	A.04.00

Marker

See “Marker Control Mode” on page 1039.

See “Setting the Marker X Axis Value” on page 1040.

See “Setting the Marker X Position in Trace Points” on page 1040.

See “Setting the Marker Y Axis Value” on page 1042.

The Marker key accesses the Marker menu. A marker can be placed on a trace to allow the value of the trace at the marker point to be determined precisely. The functions in this menu include a 1-of-N selection of the control mode Normal, Delta, Fixed, or Off for the selected marker. If the selected marker is Off, pressing Marker sets it to Normal and places it at the center of the screen on the trace determined by the Marker Trace rules.

Markers may also be used in pairs to read the difference (or delta) between two data points. They can be used in Marker Functions to do advanced data processing, or to specify operating points in functions like Signal Track and N dB Points.

The command in the table below selects the marker and sets the marker control mode as described under **Normal**, **Delta**, **Fixed** and **Off**, below. All interactions and dependencies detailed under the key description are enforced when the remote command is sent.

Key Path	Front-panel key
Remote Command	:CALCulate:MARKer [1] 2 3 4 5 6 7 8 9 10 11 12 :MODE POSITION DELTA FIXed OFF :CALCulate:MARKer [1] 2 3 4 5 6 7 8 9 10 11 12 :MODE?
Preset	OFF (all markers)
State Saved	The marker control mode is saved in instrument state
Backwards Compatibility SCPI	:CALCulate:MARKer[1] 2 3 4 5 6 7 8 9 10 11 12:MODE SPAN BAND These parameters are aliased to POSITION if sent. A query does not reflect them.
Initial S/W Revision	Prior to A.02.00

Marker Control Mode

There are four control modes for markers:

Normal (POSITION) - A marker that can be moved to any point on the X Axis by specifying its X Axis value, and whose absolute Y Axis value is then the value of the trace point at that X Axis value.

Delta (DELTA) - A marker that can be moved to any point on the X Axis by specifying its X Axis offset from a reference marker, and whose absolute Y Axis value is then the value of the trace point at that X Axis value.

Fixed (FIXed) - A marker whose X Axis and Y Axis values may be directly or indirectly specified by you, but whose Y Axis value remains fixed, once specified, and does not follow the trace. Fixed markers

Marker

are useful as reference markers for Delta markers, as operands in a Peak Search operation, and as arbitrary reference points settable by you. These markers are represented on the display by an “X” rather than a diamond.

Off (OFF) - A marker which is not in use.

In the Swept SA measurement, the Preset control mode is **Off** for all markers.

Setting the Marker X Axis Value

The command below sets the marker X Axis value in the current marker X Axis Scale unit. In each case the marker that is addressed becomes the selected marker. It has no effect (other than to cause the marker to become selected) if the control mode is **Off**, but it is the SCPI equivalent of entering an X value if the control mode is **Normal**, **Delta**, or **Fixed**.

Remote Command	:CALCulate:MARKer [1] 2 3 4 5 6 7 8 9 10 11 12 :X <freq> :CALCulate:MARKer [1] 2 3 4 5 6 7 8 9 10 11 12 :X?
Notes	<p>If no suffix is sent it will use the fundamental units for the current marker X Axis Scale. If a suffix is sent that does not match the current marker X Axis Scale unit, an invalid suffix error will be generated.</p> <p>If the specified marker is Fixed and a Marker Function is on, a message is generated. If the key is pressed, an advisory message is generated. If the equivalent SCPI command is sent, this same message is generated as part of a “-221, Settings conflict” warning.</p> <p>The query returns the marker’s absolute X Axis value if the control mode is Normal or Fixed. It returns the offset from the marker’s reference marker if the control mode is Delta. The query is returned in the fundamental units for the current marker X Axis scale: Hz for Frequency and Inverse Time, seconds for Period and Time. If the marker is Off the response is not a number.</p>
Preset	After a preset, if X is queried with no value sent first, the center of screen value will be returned. This will depend on the frequency range of the instrument. 13.255 GHz is correct for the 26 GHz instruments only (Option 526).
Min	$-\infty$ (minus infinity)
Max	$+\infty$ (plus infinity). Unlike legacy analyzers, where the markers were forced to be on screen, X-Series marker values are not limited and do not clip
Backwards Compatibility SCPI	:CALCulate:MARKer [1] 2 3 4 :X:CENTer
Initial S/W Revision	Prior to A.02.00
Default Unit	determined by X Axis Scale

Setting the Marker X Position in Trace Points

The command below sets the marker X position in trace points. It has no effect if the marker control mode is **Off**. But it is the SCPI equivalent of entering a value if the control mode is **Normal** or **Delta** or **Fixed** – except the setting is in trace points rather than X Axis Scale units.

NOTE The entered value in Trace Points is immediately translated into the current X Axis Scale units for setting the value of the marker. The marker's value in X Axis Scale Units, NOT trace points, will be preserved if a change is made to the X Axis scale settings. Thus, if you use this command to place a marker on bucket 500, which happens at that time to correspond to 13 GHz, and then you change the Start Frequency so that bucket 500 is no longer 13 GHz, the marker will stay at 13 GHz, NOT at bucket 500! This is important to realize as it differs from the behavior of past Agilent analyzers.

Remote Command	:CALCulate:MARKer [1] 2 3 4 5 6 7 8 9 10 11 12 :X:POSition <real> :CALCulate:MARKer [1] 2 3 4 5 6 7 8 9 10 11 12 :X:POSition?
Notes	If the specified marker is Fixed and a Marker Function is on, a message is generated. If the key is pressed, an advisory message is generated. If the equivalent SCPI command is sent, this same message is generated as part of a “-221, Settings conflict” warning. The query returns the marker's absolute X Axis value in trace points if the control mode is Normal or Fixed . It returns the offset from the marker's reference marker in trace points if the control mode is Delta . The value is returned as a real number, not an integer, corresponding to the translation from X Axis Scale units to trace points
Preset	After a preset, if X is queried with no value sent first, the center of screen value will be returned. So if per default, the number of Trace points is 1001, the center value will be 500.
Min	0
Max	Number of trace points – 1
Backwards Compatibility SCPI	:CALCulate:MARKer[1] 2 3 4:X:POSition:CENTer
Backwards Compatibility SCPI	The legacy command, :CALCulate:MARKer[n]:X:POSition:CENTer <param> was used to control the center point between the Delta and Reference marker in trace points (buckets) in Span Pair mode. In the new system, this is equivalent to simply setting the marker position in trace points. So this command is aliased to the command :CALCulate:MARKer[n]:X:POSition <param> <hr/> NOTE The UP/DOWN parameters will increment/decrement by one bucket. This will require a conversion to buckets and back. <hr/>
Initial S/W Revision	Prior to A.02.00

Marker

Default Unit	unitless
--------------	----------

Setting the Marker Y Axis Value

The command below selects the marker and sets the marker Y Axis value; the default unit is the current Y Axis unit. It has no effect (other than selecting the marker) unless the marker control mode is **Fixed**.

Remote Command	:CALCulate:MARKer [1] 2 3 4 5 6 7 8 9 10 11 12 :Y <real> :CALCulate:MARKer [1] 2 3 4 5 6 7 8 9 10 11 12 :Y?
Example	CALC:MARK2:MODE POS turns on marker 2 as a normal marker. CALC:MARK2:X 20 GHZ moves marker 2 to 20 GHz if X Axis Scale is Frequency. If X Axis Scale is Time, the -131 invalid suffix error is generated.
Preset	Trace value at center of screen. There is no way to predict what this will be after a preset.
Min	$-\infty$ (minus infinity)
Max	$+\infty$ (plus infinity)
Initial S/W Revision	Prior to A.02.00

Select Marker

Specifies the selected marker. The term “selected marker” is used throughout this document to specify which marker will be affected by the functions.

Key Path	Marker
Notes	The selected marker is remembered even when not in the Marker menu and is used if a Search is done or a Band Function is turned on or for Signal Track or Continuous Peak.
Preset	Marker 1
State Saved	The number of the selected marker is saved in instrument state.
Initial S/W Revision	Prior to A.02.00

Normal

Sets the control mode for the selected marker to **Normal** and turns on the active function for setting its value. If the selected marker was **Off**, it is placed at the center of the screen on the trace specified by the marker’s Trace attribute.

A Normal mode (POSition type) marker can be moved to any point on the X Axis by specifying its X Axis value. Its absolute Y Axis value is then the value of the trace point at that X Axis value.

Key Path	Marker
Example	:CALC:MARK:MODE POS sets Marker 1 to Normal.

Notes	See the description under the “ Marker” key.
Couplings	<ul style="list-style-type: none"> The marker addressed by this command becomes the selected marker on the front panel.
State Saved	The marker control mode (Normal, Delta, Fixed, Off) and X Axis value are saved in instrument state.
Initial S/W Revision	Prior to A.02.00

Delta

Sets the control mode for the selected marker to Delta and turns on the active function for setting its delta value. If the selected marker was **Off**, it is placed at the center of the screen on the trace specified by the marker’s Trace attribute.

In Delta mode the marker result shows the relative result between the selected (Delta) marker and its reference marker. A delta marker can be moved to any point on the X Axis by specifying its X Axis offset from a reference marker. Its absolute Y Axis value is then the value of the trace point at that X Axis value.

Key Path	Marker
Example	:CALC:MARK:MODE DELT sets marker 1 to Delta.
Notes	See the description under the “ Marker” key.
State Saved	The marker control mode (Normal, Delta, Fixed, Off) and X Axis value are saved in instrument state
Initial S/W Revision	Prior to A.02.00

Fixed

See [“Fixed Marker X Axis Value”](#) on page 1044.

See [“Fixed Marker Y Axis Value”](#) on page 1044.

Sets the control mode for the selected marker to Fixed. A fixed marker is fixed in the sense that it stays where you place it. It can be directly moved in both X and Y. It can be moved with a Peak Search. It can also be indirectly moved by re-zeroing the delta if it is a relative marker. If it is moved, it again becomes fixed at the X Axis point it moved to and it has a Y-axis result that it took on when it moved there. If a Normal or Delta marker is changed to Fixed it becomes fixed at the X Axis point it was at, and with the Y-axis result it had when it was set to Fixed.

In Fixed mode the marker result shows:

- If no Marker Function is on, the absolute X Axis and Y axis value of the marker
- If a Marker Function is on, the X Axis value and the Y-axis function result the marker had when it became fixed.

Marker

Fixed Marker X Axis Value

Key Path	Marker, Fixed
Example	:CALC:MARK:MODE FIX sets Marker 1 to Fixed.
Notes	See the description under the “ Marker” key, above.
Dependencies	<p>You cannot directly set the X or Y value of a Fixed marker which has a marker function turned on. If an attempt is made to actually adjust it while a Marker Function is on, a message is generated. If the key is pressed, an advisory message is generated. If the equivalent SCPI command is sent, this same message is generated as part of a “–221, Settings conflict” warning.</p> <p>You cannot directly set the Y value of a Fixed marker while Normalize is turned on. If an attempt is made to do so while Normalize is on, a message is generated. If the key is pressed, an advisory message is generated. If the equivalent SCPI command is sent, this same message is generated as part of a “–221, Settings conflict” warning.</p>
State Saved	The marker control mode (Normal, Delta, Fixed, Off) and X and Y Axis values are saved in instrument state
Initial S/W Revision	Prior to A.02.00

Fixed Marker Y Axis Value

Key Path	Marker, Fixed
Example	:CALC:MARK:MODE FIX sets Marker 1 to Fixed.
Notes	See the description under the Marker key.
Dependencies	<p>You cannot directly set the X or Y value of a Fixed marker which has a marker function turned on. If an attempt is made to actually adjust it while a Marker Function is on, a message is generated. If the key is pressed, an advisory message is generated. If the equivalent SCPI command is sent, this same message is generated as part of a “–221, Settings conflict” warning.</p>
State Saved	The marker control mode (Normal, Delta, Fixed, Off) and X and Y Axis values are saved in instrument state
Initial S/W Revision	Prior to A.02.00
Default Unit	depends on the current selected Y axis unit

Off

Turns off the selected marker and its marker function setting, if any. However, Off does not affect which marker is selected.

Key Path	Marker
Example	:CALC:MARK:MODE OFF sets Marker 1 to Off.

Notes	See the description under the “ Marker” key.
State Saved	The marker control mode (Normal, Delta, Fixed, Off) is saved in instrument state
Initial S/W Revision	Prior to A.02.00

Properties

Opens a menu used to set certain properties of the selected marker.

Key Path	Marker
Initial S/W Revision	Prior to A.02.00

Select Marker

Duplicate of the **Select Marker** key under **Marker**. Selecting a marker here causes the same marker to be selected under **Marker**. (That is, there is only one “selected marker”.)

Relative To

Selects the marker that the selected marker will be relative to (its reference marker).

Every marker has another marker to which it is relative. This marker is referred to as the “reference marker” for that marker. This attribute is set by the **Marker, Properties, Relative To** key. The marker must be a **Delta** marker to make this attribute relevant. If it is a **Delta** marker, the reference marker determines how the marker is controlled and how its value is displayed. A marker cannot be relative to itself.

Key Path	Marker, Properties
Remote Command	:CALCulate:MARKer [1] 2 3 4 5 6 7 8 9 10 11 12:REFerence <integer> :CALCulate:MARKer [1] 2 3 4 5 6 7 8 9 10 11 12:REFerence ?
Example	CALC:MARK1:REF 2 sets the marker 1 reference marker to 2 and turns marker 1 on as a delta marker.
Notes	A marker cannot be relative to itself so that choice is grayed out. If the grayed out key is pressed, an advisory message is generated. If the equivalent SCPI command is sent, this same message is generated as part of a “–221, Settings conflict” warning. See error –221.2200 in Master Error Messages: X-Series document for exact error text.
Notes	This command causes the marker specified with the subopcode to become selected. Range (for SCPI command): 1 to 12. If the range is exceeded the value is clipped.

Marker

Couplings	The act of specifying the selected marker's reference marker makes the selected marker a Delta marker. If the reference marker is off it is turned on in Fixed mode at the delta marker location.
Preset	The preset default "Relative To" marker (reference marker) is the next higher numbered marker (current marker +1). For example, if marker 2 is selected, then it's default reference marker is marker 3. The exception is marker 12, which has a default reference of marker 1. Set to the defaults by using Restore Mode Defaults . This is not reset by Marker Off , All Markers Off , or Preset .
State Saved	Saved in instrument state. Not affected by Marker Off and hence not affected by Preset or power cycle.
Min	1
Max	12
Status Bits/OPC dependencies	none Default (selected when Restore Mode Defaults is pressed): next higher numbered marker or 1 if marker 12.
Initial S/W Revision	Prior to A.02.00

X Axis Scale (formerly Readout)

Accesses a menu that enables you to affect how the X Axis information for the selected marker is displayed in the marker area (top-right of display) and the active function area of the display, and how the marker is controlled. The available settings for the X Axis Scale are Frequency, Period, Time, and Inverse Time.

See "[More Information](#)" on page 1047.

Key Path	Marker, Properties
Remote Command	:CALCulate:MARKer [1] 2 3 4 5 6 7 8 9 10 11 12 :X:READout FREQuency TIME ITIME PERiod :CALCulate:MARKer [1] 2 3 4 5 6 7 8 9 10 11 12 :X:READout ? :CALCulate:MARKer [1] 2 3 4 5 6 7 8 9 10 11 12 :X:READout :AUTO ON OFF 1 0 :CALCulate:MARKer [1] 2 3 4 5 6 7 8 9 10 11 12 :X:READout :AUTO?
Example	CALC:MARK3:X:READ TIME sets the marker 3 X Axis Scale to Time.
Notes	This command causes the specified marker to become selected.
Preset	AUTO Marker Preset (selected when a marker is turned Off): Auto (see below). In most measurements the Auto settings results in Frequency being the preset readout.

State Saved	Saved in instrument state
Initial S/W Revision	Prior to A.02.00

More Information

The **X Axis Scale** of a marker is the scale of its X Axis value. This affects the units displayed in the Marker Result block and used to specify the marker's X Axis location. The X Axis Scale is specified using the **Marker, Properties, X Axis Scale** key.

All markers in swept spans have both a time and frequency value. Which of these is used for the result display, and for positioning the marker, depends on the **X Axis Scale** setting. The **X Axis Scale** setting can be **Frequency** or **Time**, as well as the reciprocal of either (**Period** or **Inverse Time**). There is also an **Auto** setting - when in **Auto**, a marker's **X Axis Scale** changes whenever the domain of the trace, upon which it set, changes. All choices for **X Axis Scale** are allowed. Note that this behavior differs from the behavior in previous instruments: previously the instrument remembered a different **X Axis Scale** (formerly called **Readout**) for each domain, and the choices of **X Axis Scale** were restricted. These restrictions were based on the current domain of the instrument.

Auto

When in Auto, the X-Axis Scale is **Frequency** if the Marker Trace is a frequency domain trace, **Time** if the Marker Trace is a time domain trace. When in Auto, if the marker changes traces, or the domain of the trace the marker is on changes, the auto result is re-evaluated. If the X Axis Scale is chosen manually, that Scale is used regardless of the domain of the trace.

Key Path	Marker, Properties, X Axis Scale
Example	CALC:MARK2:X:READ:AUTO ON sets the marker 2 X-axis scaling to automatically select the most appropriate units.
Initial S/W Revision	Prior to A.02.00

Frequency

Sets the marker X Axis scale to Frequency, displaying the absolute frequency of a normal marker or the frequency of the delta marker relative to the reference marker. Frequency is the auto setting for frequency domain traces.

If Frequency is selected for a time domain trace, all of the points in the trace will show the same value. Attempting to use the knob or step keys to adjust the X Axis value of the marker or entering an X Axis value from the numeric keypad or remotely will have no effect but will generate no error.

Key Path	Marker, Properties, X Axis Scale
Example	CALC:MARK2:X:READ:FREQ sets the marker 2 X Axis scale to Frequency.
Notes	1-of-N readback is Frequency
State Saved	The X Axis Scale setting is saved in instrument state.
Initial S/W Revision	Prior to A.02.00

Marker

Period

Sets the marker X Axis scale to Period, displaying the reciprocal of the frequency of the marker, or the reciprocal of the frequency separation of the two markers in a delta-marker mode. The units are those of time (sec, msec, etc). If the markers are at the same frequency in a delta marker mode, the result will be the reciprocal of 0, which is infinitely large. The display will show “---” and a SCPI query will return infinity.

If Period is selected for a time domain trace, all of the points in the trace will show the same value. Attempting to use the knob or step keys to adjust the X Axis value of the marker or entering an X Axis value from the numeric keypad or remotely will have no effect but will generate no error.

Key Path	Marker, Properties, X Axis Scale
Example	CALC:MARK2:X:READ PER sets the marker 2 X Axis scale to Period.
Notes	1-of-N readback is Period
State Saved	The X Axis Scale setting is saved in instrument state.
Initial S/W Revision	Prior to A.02.00

Time

Sets the marker X Axis scale to Time, displaying the time interval between a normal marker and the start of a sweep or the time of the delta marker relative to the reference marker. Time is the auto setting for time domain traces. In a delta-marker mode it is the (sweep) time interval between the two markers.

Key Path	Marker, Properties, X Axis Scale
Example	CALC:MARK2:X:READ TIME sets the marker 2 X Axis Scale to Time..
Notes	1-of-N readback is Time
Couplings	Frequency domain traces taken in FFT mode have no valid time data. Therefore when Time is selected for markers on such traces, the X Axis value is taken as the appropriate percentage of the displayed sweep time, which is a calculated estimate.
State Saved	The X Axis Scale setting is saved in instrument state
Initial S/W Revision	Prior to A.02.00

Inverse Time

Sets the marker X Axis scale to Inverse Time, displaying the reciprocal time. It is useful in a delta mode to show the reciprocal of (sweep) time between two markers. This function is only meaningful when on a time domain trace and in the **Delta** control mode. If the markers are at the same X Axis value, the time between them is 0, so the reciprocal of sweep time is infinitely large. The display will show “---” and a SCPI query will return infinity.

Key Path	Marker, Properties, X Axis Scale
Example	:CALC:MARK2:X:READ ITIM sets the marker 2 X Axis scale to Inverse Time.

Notes	1-of-N readback is Inverse Time
Couplings	Frequency domain traces taken in FFT mode have no valid time data. Therefore when Inverse Time is selected for markers on such traces, the X Axis value is undefined, shows as “---” and returns not a number to a query.
State Saved	The X Axis Scale setting is saved in instrument state
Initial S/W Revision	Prior to A.02.00

Marker Trace

Selects the trace that you want your marker to be placed on. A marker is associated with one and only one trace. This trace is used to determine the placement, result, and X Axis Scale of the marker. All markers have an associated trace, even **Fixed** markers; it is from that trace that they determine their attributes and behaviors, and it is to that trace that they go when they become Normal or Delta markers.

See [“Auto Init On” on page 1050.](#)

See [“Auto Init Rules Flowchart” on page 1050.](#)

See [“Auto Init OFF” on page 1050.](#)

Key Path	Marker, Properties
Remote Command	:CALCulate:MARKer [1] 2 3 4 5 6 7 8 9 10 11 12 :TRACe 1 2 3 4 5 6 :CALCulate:MARKer [1] 2 3 4 5 6 7 8 9 10 11 12 :TRACe?
Example	CALC:MARK1:TRAC 2 places marker 1 on trace 2.
Notes	A marker may be placed on a blanked and/or inactive trace, even though the trace is not visible and/or updating. An application may register a trace name to be displayed on the key instead of a trace number.
Couplings	The state of Marker Trace is not affected by the Auto Couple key. If a Marker Trace is chosen manually, Auto Init goes to Off for that marker. Sending the remote command causes the addressed marker to become selected.
Preset	Presets on Preset or All Markers Off
State Saved	The Marker Trace and state of Auto Init for each marker is saved in instrument state.
Min	1
Max	6
Readback line	[TraceN, Auto Init] or [TraceN, Manual] where N is the trace number to which the marker is currently assigned.
Initial S/W Revision	Prior to A.02.00

Marker

Auto Init On

When **Auto Init** is true, the marker's trace attribute is re-determined automatically by the analyzer whenever the marker turns on (Normal, Delta or Fixed) from an Off state. (The trace attribute is also determined for all markers that are on, whenever **Auto Init** is turned on).

When the marker moves between traces the marker's X position in trace points is retained as it moves. For moving between active traces this generally means the x-axis value of the marker will not change. But for moving to or from an inactive trace, the x-axis value will take on that of the new trace at the bucket the marker was on the old trace (and is still on, on the new trace, since the bucket doesn't change).

Note this is true even if the marker is off screen. Thus, a marker that is at the center of the screen on the old trace stays at the center of the screen on the new trace. A marker that is off screen one whole screen to the left on the old trace remains off screen one whole screen to the left on the new trace – even if this means it will be at negative time!

Marker Trace is set to 1, and Auto Init is set to On, on a Preset or All Markers Off.

Auto Init Rules Flowchart

The following flowchart depicts the Auto Init rules:

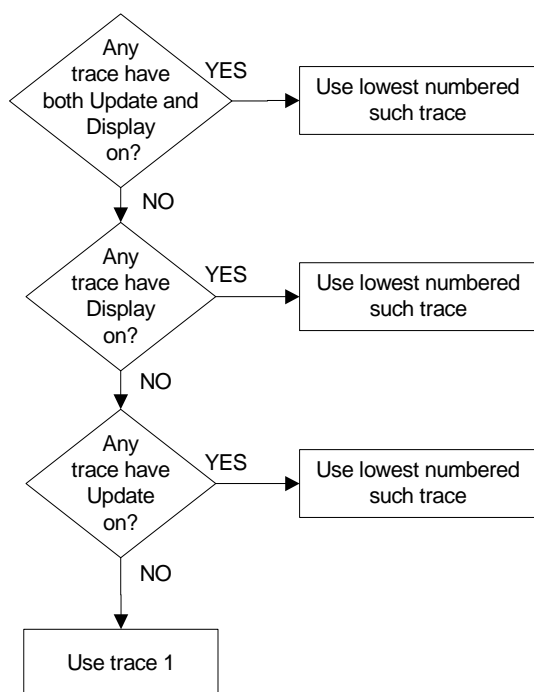

This flowchart makes it clear that putting all lower-numbered traces in View is the simplest way to specify which trace you want the markers to go to when they turn on. For example, if you want all Markers to go to trace 2 when they turn on, put trace 1 in View.

Auto Init OFF

This command associates the marker with the specified trace and turns Marker Trace, Auto Init OFF for that marker. If the marker is not **Off** it moves the marker from the trace it was on to the new trace. If the marker is **Off** it stays off but is now associated with the specified trace.

The query returns the number of the trace on which the marker is currently placed, even if that marker is in Auto mode.

Remote Command	:CALCulate:MARKer [1] 2 3 4 5 6 7 8 9 10 11 12 :TRACe:AUTO OFF ON 0 1 :CALCulate:MARKer [1] 2 3 4 5 6 7 8 9 10 11 12 :TRACe:AUTO?
Notes	Turning Marker Trace Auto Init off has no effect on the trace on which the marker is currently placed. The response to the query will be 0 if OFF, 1 if ON.
Couplings	The state of Auto Init is not affected by the Auto Couple key. Auto Init is set to True on a Preset or All Markers Off. If Auto Init is set to On for a marker and that marker is on, that marker's Marker Trace is immediately set according to the above flowchart. Sending the remote command causes the addressed marker to become selected.
Preset	ON
Initial S/W Revision	Prior to A.02.00

Lines

When on, displays a vertical line of graticule height and a horizontal line of graticule width, intersecting at the indicator point of the marker (that is, the center of the X or the bottom tip of the diamond. The lines are blue in color.

If the marker is off screen the lines should be extended from the marker so that they go thru the screen area if possible. This is really useful for off screen Fixed markers as it lets you see their amplitude even though they are off the X Axis.

Key Path	Marker, Properties
Remote Command	:CALCulate:MARKer [1] 2 3 4 5 6 7 8 9 10 11 12 :LINES[:STATE] OFF ON 0 1 :CALCulate:MARKer [1] 2 3 4 5 6 7 8 9 10 11 12 :LINES[:STATE] ?
Example	:CALC:MARK2:LIN:ON turns Lines on for marker 2.
Couplings	Sending the remote command causes the addressed marker to become selected.
Preset	OFF
State Saved	Saved in State
Initial S/W Revision	Prior to A.02.00

Marker

Marker Table

When set to On the display is split into a measurement window and a marker data display window. For each marker which is on, information is displayed in the data display window, which includes the marker number, control mode, trace number, X axis scale, X axis value, and the Y-axis result. Additional information is shown for markers which have marker functions turned on.

Turning the Marker Table on turns the Peak Table off and vice versa.

Key Path	Marker
Remote Command	:CALCulate:MARKer:TABLE[:STATe] OFF ON 0 1 :CALCulate:MARKer:TABLE[:STATe]?
Example	CALC:MARK:TABL ON turns on the marker table.
Preset	OFF
State Saved	Whether the marker table is on is saved in instrument state
Initial S/W Revision	Prior to A.02.00

Marker Count

Accesses the marker count menu.

Key Path	Marker
Readback line	[On] if count on for the selected marker, [Off] if it is off.
Initial S/W Revision	Prior to A.02.00

Counter

Turns the marker frequency counter on and off. The selected marker is counted, and if the selected marker is a delta marker and its reference marker is not fixed, the reference marker is counted as well.

See [“Understanding the Marker Counter”](#) on page 1054.

See [“Query Count Value”](#) on page 1053.

Key Path	Marker, Marker Count
Remote Command	:CALCulate:MARKer[1] 2 3 4 5 6 7 8 9 10 11 12:FCOunt[:S TATE] OFF ON 0 1 :CALCulate:MARKer[1] 2 3 4 5 6 7 8 9 10 11 12:FCOunt[:S TATE]?
Example	CALC:MARK2:FCO ON selects marker 2, turns it on, and turns on the counter CALC:MARK2:FCO:X? returns the counted frequency.

Notes	<p>Fixed markers are not counted, but a Fixed marker will have a count stored in it if it is selected or is the reference marker for the selected marker. The count already in the marker is stored when the marker becomes fixed and if there is none or the marker moves (for example, Pk Search) it is counted and stored after the next sweep.</p> <p>If a Fixed marker has a count stored in it, that count will be displayed when the marker is selected, and used as the reference count when that marker is a reference marker.</p> <p>If a Fixed marker has a count stored in it, that count will be deleted if the marker X is adjusted.</p> <p>If a Fixed marker has a count stored in it, and a Search function is performed using the Fixed marker, while the counter is on, the count stored in the marker will be updated.</p> <p>If a Fixed marker has a count stored in it, and is a reference marker, and the reference is moved to a valid trace point by re-zeroing the delta (by pressing Delta again or sending the DELTA SCPI command), while the counter is on, the count stored in the marker will be updated.</p>
Notes	This command causes the specified marker to become selected.
Dependencies	Marker Count is unavailable (grayed out and Off) if the Gate function is on.
Couplings	<p>If the selected marker is Off when the counter is turned on, the selected marker is set to Normal and placed at center of screen on the trace determined by the Marker Trace rules.</p> <p>If a marker which is OFF is selected while the counter is on, the counter remains on, but since the marker is off, the count is undefined. In this case the analyzer will return not a number to a SCPI count query.</p> <p>The counter is turned OFF when the selected marker is turned OFF.</p>
Preset	OFF
State Saved	The state of the counter (on/off) is saved in instrument state. In the case of Fixed markers, the count stored in the marker is saved in instrument state.
Initial S/W Revision	Prior to A.02.00

Query Count Value

Queries the frequency count. The query returns the absolute count unless the specified marker is in Delta mode, then it returns the relative count. If the marker is off, or the marker is on but the counter is off, the analyzer will return not a number to a SCPI count query. A marker with no stored count, or a non-**Fixed** marker on a stored trace, will also return not a number to a SCPI count query. Note this result may simply mean that the first sweep after the counter turned on has not yet completed.

Remote Command	:CALCulate:MARKer [1] 2 3 4 5 6 7 8 9 10 11 12 :FCount :X?
Notes	This query does NOT cause the specified marker to become selected.
Initial S/W Revision	Prior to A.02.00

Marker

Understanding the Marker Counter

See [“Counting Off-screen Markers”](#) on page 1054.

See [“Delta Marker”](#) on page 1054.

See [“Fixed Markers”](#) on page 1054.

See [“More Information on "Counter"”](#) on page 1055.

Using the internal counter we can count the frequency of a marker, but we cannot count while we are actually sweeping. So, once we are done with a sweep, we move to the selected marker frequency and count that frequency. Then, if the marker is a Delta marker, the count is also taken for its reference marker. The count is actually performed by moving the LO to the frequency (or frequencies in the case of a delta marker) we wish to count. The count is executed on a marker by marker basis and no further count is taken until after the next sweep (even if the marker moves before another sweep has completed).

The Marker Count is taken by tuning the instrument to the frequency of the marker and counting the IF, with the instrument not sweeping. The count is adjusted for display by adding or subtracting it (as appropriate) from the LO frequency, so that you see a count that represents the signal frequency. This is true even if External Mixing is on. Since all this happens between sweeps, you never see the instrument retuning to do the counts.

If you wish to see the entered frequency of a counted marker it will appear in the active function area when that marker is selected (for Fixed markers, you have to press the Marker, Fixed key to select Fixed markers and then press it a second time to view or adjust the x or y marker values).

Counting Off-screen Markers

If the selected marker is off the X-axis the instrument can still be tuned to the marker (unless it is outside the range of the instrument), so the count can still be displayed. This means you can see a count for an off-screen marker even though there may be no valid Y-value for the marker. If the marker frequency is outside the range of the instrument, the display will show three dashes in the count block (---), and not a number is returned to a SCPI count query.

Delta Marker

When a Delta Marker is selected while Marker Count is on:

1. If the reference marker is not a fixed marker, the display shows the difference between the count of the selected marker and the count of the reference marker
2. If the reference marker is a fixed marker and there is a count stored in the marker (because Marker Count was on when the marker became a fixed marker), the display shows the difference between the count at the marker and the count stored in the reference marker.

Marker Count works in zero span as well as in Swept SA. The instrument tunes to the frequency of the selected marker, which, for active zero span traces, is simply the center frequency of the analyzer.

Fixed Markers

Fixed markers have a count stored in them that is generally kept fixed and not updated. If a fixed marker is selected, or used as a reference, the signal at the marker frequency is not counted; rather the stored count is seen or used as the reference. The count is stored, if Count is on, when the marker becomes fixed

or when, while fixed, the marker is moved by re-zeroing the reference (if it is the reference marker) or via a peak search (since both of these, by definition, use valid trace data). The count stored in a Fixed marker is lost if the counter is turned off, if the marker is moved to an inactive trace, or if the marker is moved by adjusting its x-value.

More Information on "Counter"

When the counter is on, the count (or the delta count) for the selected marker is displayed.

The invalid data indicator (*) will turn on until the completion of the first count.

Marker Count frequency readings are corrected using the **Freq Offset** function (in some previous analyzers, they were not). Note however that Marker Delta readings are not corrected, as any offset would be applied to both.

In zero span on active traces the counter continues to function, counting any signal near the center frequency of the analyzer.

NOTE No signal farther from the marker frequency than the Res BW will be seen by the counter.

The above command turns on or off the frequency counter. If the specified marker number in the command is not the selected marker, it becomes the selected marker. If the specified marker number is not on, FCount ON sets it to Normal and places it at center of screen on the trace determined by the Marker Trace rules. Once the marker count is on, it is on for any selected marker, not just for the one used in the command. A 1 is returned to the state query only if marker count is on and the specified number is the selected marker. The invalid data indicator (*) will turn on until the completion of the first count but this does not keep a value from being returned.

Gate Time

Controls the length of time during which the frequency counter measures the signal frequency. Longer gate times allow for greater averaging of signals whose frequency is “noisy”, though the measurement takes longer. If the gate time is an integer multiple of the length of a power-line cycle (20 ms for 50 Hz power, 16.67 ms for 60 Hz power), the counter rejects incidental modulation at the power line rate. The shortest gate time that rejects both 50 and 60 Hz modulation is 100 ms, which is the value chosen in Auto, or on Preset or when Auto Couple is pressed.

The start time of the Gate Time of the counter must be controlled by the same trigger parameters as controls the sweep. Thus, if the Trigger is not in Free Run, the counter gate must not start until after the trigger is received and delayed.

Key Path	Marker Function, Marker Count
----------	-------------------------------

Marker

Remote Command	<pre>:CALCulate:MARKer [1] 2 3 4 5 6 7 8 9 10 11 12 :FCOunt :GAT etime <time> :CALCulate:MARKer [1] 2 3 4 5 6 7 8 9 10 11 12 :FCOunt :GAT etime? :CALCulate:MARKer [1] 2 3 4 5 6 7 8 9 10 11 12 :FCOunt :GAT etime:AUTO OFF ON 0 1 :CALCulate:MARKer [1] 2 3 4 5 6 7 8 9 10 11 12 :FCOunt :GAT etime:AUTO?</pre>
Example	:CALC:MARK2:FCO:GAT 1e-2 sets the gate time for Marker 2 to $10^{(-2)}$ s = 10 ms.
Notes	When Auto Couple is pressed, Gate Time is set to 100 ms.
Notes	This command causes the specified marker to become selected.
Preset	100 ms ON
State Saved	Saved in instrument state.
Min	1 us
Max	500 ms
Initial S/W Revision	Prior to A.02.00

Couple Markers

When this function is true, moving any marker causes an equal X Axis movement of every other marker which is not Fixed or Off. By “equal X Axis movement” we mean that we preserve the difference between each marker’s X Axis value (in the fundamental x-axis units of the trace that marker is on) and the X Axis value of the marker being moved (in the same fundamental x-axis units).

Note that Fixed markers do not couple. They stay where they were while all the other markers move. Of course, if a Fixed marker is being moved, all the non-fixed markers do move with it.

This may result in markers going off screen.

Key Path	Marker
Remote Command	<pre>:CALCulate:MARKer:COUPle [:STATe] OFF ON 0 1 :CALCulate:MARKer:COUPle [:STATe] ?</pre>
Example	:CALC:MARK:COUP ON sets Couple Markers on.
Preset	Off, presets on Mode Preset and All Markers Off
State Saved	Saved in instrument state
Initial S/W Revision	Prior to A.02.00

All Markers Off

Turns off all markers. See Marker, “Off” on page 1044.

Key Path	Marker
Remote Command	:CALCulate:MARKer:AOff
Example	CALC:MARK:AOff turns off all markers.
Couplings	sets the selected marker to 1.
Preset	n/a.
Initial S/W Revision	Prior to A.02.00

Marker

Marker Function

The Marker Function key opens up a menu of softkeys that allow you to control the Marker Functions of the instrument. Marker Functions perform post-processing operations on marker data. Band Functions are Marker Functions that allow you to define a band of frequencies around the marker. The band defines the region of data used for the numerical calculations. These marker functions also allow you to perform mathematical calculations on trace and marker data and report the results of these calculations in place of the normal marker result.

NOTE Unlike regular markers, marker function markers are not placed directly on the trace. They are placed at a location which is relative to the result of the function calculation.

See [“More Information”](#) on page 1059.

See [“Fixed marker functions”](#) on page 1060.

See [“Interval Markers”](#) on page 1060.

Key Path	Front-panel key
Remote Command	:CALCulate:MARKer [1] 2 3 4 5 6 7 8 9 10 11 12 :FUNCTION NOISE BPOWER BDENSity OFF :CALCulate:MARKer [1] 2 3 4 5 6 7 8 9 10 11 12 :FUNCTION?
Notes	Sending this command selects the subpcoded marker The marker function result is queried in the same fashion as the Marker Result, as outlined in the Marker section, with the CALC:MARK:Y? command.
Dependencies	Fixed markers: It is not possible to change the Band Function for a Fixed marker; so all of the Band Function keys are grayed out for a Fixed marker. If a marker function was already on when the marker became Fixed then the selected Band Function is shown but cannot be changed. Therefore, you cannot directly set the X or Y value of a Fixed marker which has a marker function turned on. To turn off the function, turn off the marker.
Preset	OFF
State Saved	The band function for each marker is saved in Instrument State
Initial S/W Revision	Prior to A.02.00

More Information

The units to be used for displaying Marker Function results in Delta mode vary depending on what is the reference marker and what it is referenced to.

Marker Functions are different from Measurements, which automatically perform complex sequences of setup, data acquisition, and display operations in order to measure specified signal characteristics.

Marker Function

Marker Functions are specified for each individual marker and may be turned on individually for each marker.

The **Marker Fctn** menu controls which marker functions are turned on and allows you to adjust setup parameters for each function. The Marker Functions are **Marker Noise**, **Band/Interval Power**, and **Band/Interval Density**, only one of which can be on for a given marker.

If the selected marker is off, pressing Marker Fctn sets it to Normal and places it at the center of the display on the trace determined by the Marker Trace rules. However, if the selected marker was **Off**, **Marker Function Off** had to be the selected function, and it remains so even after the marker is thus turned on, although you may then change it.

Fixed marker functions

In the case of a fixed marker, it is not possible to turn on or change a band function. This is because a Fixed marker holds the value it had when it became fixed; the trace it was on may keep on changing, so the function value, which depends on trace data, could not be calculated on an ongoing basis.

It is possible to have a Marker Function on for a Fixed marker, in the case where a function was already on when the marker became Fixed. In this case the function value will be retained in the marker. It is also possible to have a Marker Function on for a Fixed marker in the case when the marker was off and was turned on as **Fixed** because **Delta** was pressed to create a reference marker - in which case the marker function, marker function width, Y Axis value and marker function result that the **Delta** marker had when **Delta** was pressed are copied into the Fixed marker. If **Delta** is pressed again, causing the fixed reference marker to move to the delta marker's position, the marker function, marker function width, Y Axis value and marker function result that the **Delta** marker had when **Delta** was pressed are again copied into the fixed reference marker.

If a Marker Function is on for a Fixed marker, the marker's reported value is derived by the function. Therefore you cannot directly set the X or Y value of a Fixed marker which has a marker function turned on. Indirect setting as detailed above or when a Peak Search is performed is allowed, as the Fixed marker is always placed on a trace and can derive its function value from the trace at the moment when it is placed.

Interval Markers

What is an interval marker? The band power marker computes the total power within a span in a nonzero span. The results computation must include the RBW. The interval power marker measures the average power across some time interval in zero span.

Interval Density is defined to be Interval Power divided by Bn. Bn is the noise bandwidth of the RBW filter, as noted and used within the Band Power computation.

Select Marker

See ["Select Marker" on page 1042](#).

Marker Noise

Turns on the Marker Noise function for the selected marker, making it a noise marker. If the selected marker is off, it is turned on in **Normal** mode and located at the center of the screen.

When **Marker Noise** is selected while in the **Marker Function Off** state, the **Band Span** or **Interval**

Span is initialized to 5% of the screen width.

When **Marker Noise** is on, the marker's Y Axis Result is the average noise level, normalized to a 1 Hz noise power bandwidth, in the band specified under the **Band Adjust** key.

See [“More Information” on page 1061](#).

See [“Off-trace Markers” on page 1061](#).

Key Path	Marker Function
Example	<p>CALC:MARK:FUNC NOIS turns on marker 1 as a noise marker.</p> <p>CALC:MARK:FUNC? returns the current marker function for the marker specified. In this case it returns the string: NOIS.</p> <p>CALC:MARK:Y? returns the y-axis value of the Marker Noise function for marker 1 (if Marker Noise is ON for marker 1). Note that the delta value when the Y axis unit is Watt is the square of the delta value when the Y axis unit is Volt. For example, when the percent ratio with Y axis unit in Volt is 0.2, the percent ratio with Y axis unit in Watt will be $0.22 = 0.04$. When you read the value out remotely you have to know whether your Y Axis Unit is log (dB), linear (V or A), or power (W).</p>
Notes	See the description under the ““Marker Function” on page 1059” key.
Dependencies	Fixed markers: It is not possible to change the Band Function for a Fixed marker; so all of the Band Function keys are grayed out for a Fixed marker.
Couplings	<p>Average detector and Power Averaging auto selected when Marker Noise on</p> <p>If the selected (specified) marker is off, selecting Marker Noise via front panel or SCPI will turn the marker on.</p>
Initial S/W Revision	Prior to A.02.00

More Information

To guarantee accurate data for noise-like signals, a correction for equivalent noise bandwidth is made by the analyzer. The **Marker Noise** function accuracy is best when the detector is set to Average or Sample, because neither of these detectors will peak-bias the noise. The trade off between sweep time and variance of the result is best when Average Type is set to Power Averaging. Therefore, Auto coupling chooses the Average detector and Power Averaging when Marker Noise is on. Though the Marker Noise function works with all settings of detector and Average Type, using the positive or negative peak detector gives less accurate measurement results.

Off-trace Markers

If a **Normal** or **Delta** noise marker is so near to the left or right edge of the trace that some of the band is off the trace, then it uses only that subset of the Band Width that is on-trace. If the marker itself is off-trace, its value becomes undefined.

Neither band/interval power nor band/interval density markers are defined if any part of the band is off-trace (unless they are Fixed with a stored function value in them), except that when the edges of the bandwidth are trivially off-screen, due to mathematical limitations in the analyzer or in the controlling computer, the result will still be considered valid.

Marker Function

Band/Interval Power

Turns on the Band/Interval Power function for the selected marker. If the selected marker is off it is turned on in **Normal** marker and located at the center of the screen.

When **Band/Interval Power** is selected while in the **Marker Function Off** state, the **Band Span** or **Interval Span** is initialized to 5% of the screen width.

If the detector mode for the detector on the marker's trace is set to Auto, the average detector is selected. If the Average type is set to Auto, Power Averaging is selected. Other choices for the detector or Average type will usually cause measurement inaccuracy.

Key Path	Marker Function
Example	<p>CALC:MARK:FUNC BPOW turns on marker 1 as a band power marker.</p> <p>CALC:MARK2:FUNC? returns the current setting of marker function for marker 2. In this case it returns the string: BPOW.</p> <p>CALC:MARK:Y? returns the y-axis value of the Band Power function for marker 1. Note that the delta value when the Y axis unit is Watt is the square of the delta value when the Y axis unit is Volt. For example, when the percent ratio with Y axis unit in Volt is 0.2, the percent ratio with Y axis unit in Watt will be $0.22 = 0.04$. When you read the value out remotely you have to know whether your Y Axis Unit is log (dB), linear (V or A), or power (W).</p>
Notes	See the description under the “Marker Function” on page 1059 key, above.
Dependencies	Fixed markers: It is not possible to change the Band Function for a Fixed marker; so all of the Band Function keys are grayed out for a Fixed marker.
Couplings	<p>If the detector mode for the detector on the marker's trace is set to Auto, the average detector is selected. If the Average type is set to Auto, Power Averaging is selected.</p> <p>If the selected (specified) marker is off, selecting Band Power via front panel or SCPI will turn the marker on.</p>
Initial S/W Revision	Prior to A.02.00

Band/Interval Density

Turns on the Band/Interval Density function for the selected marker. If the selected marker is off it is turned on in **Normal** marker mode and located at the center of the screen.

When **Band/Interval Density** is selected while in the **Marker Function Off** state, the **Band Span** or **Interval Span** is initialized to 5% of the screen width.

See [“More Information” on page 1063](#).

See [“What is band/interval density?” on page 1063](#)

Key Path	Marker Function
----------	-----------------

Example	<p>CALC:MARK:FUNC BDEN turns on marker 1 as a band density marker.</p> <p>CALC:MARK:FUNC? returns the current setting of band function for the marker specified. In this case it returns the string: BDEN.</p> <p>CALC:MARK:Y? returns the y-axis value of the Band Density function for marker 1. Note that the delta value when the Y axis unit is Watt is the square of the delta value when the Y axis unit is Volt. For example, when the percent ratio with Y axis unit in Volt is 0.2, the percent ratio with Y axis unit in Watt will be $0.2^2 = 0.04$. When you read the value out remotely you have to know whether your Y Axis Unit is log (dB), linear (V or A), or power (W).</p>
Notes	<p>The zero-width case is treated as one bucket wide although it shows a width of 0.</p> <p>When the trace the marker is on crosses domains, the width crosses domains as well, to remain the same percentage of the trace</p>
Notes	See the description under the ““ Marker Function ” on page 1059” key, above.
Dependencies	Fixed markers: It is not possible to change the Band Function for a Fixed marker; so all of the Band Function keys are grayed out for a Fixed marker.
Couplings	<p>If the detector mode for the detector on the marker’s trace is set to Auto, the average detector is selected. If the Average type is set to Auto, Power Averaging is selected.</p> <p>If the selected (specified) marker is off, selecting Band Density via front panel or SCPI will turn the marker on.</p>
State Saved	n/a.
Initial S/W Revision	Prior to A.02.00

More Information

It may seem like the band density marker function is exactly like a function of a noise marker with variable width. But they are somewhat different. The Noise markers assume that the signal to be measured is noise-like. Based on this assumption, we can actually make reasonable measurements under very nonideal conditions: any detector may be used, any averaging type, any VBW. In contrast, the Band Power and Band Density markers make no assumption about the statistics of the signal.

If the detector mode for the detector on the marker’s trace is set to Auto, the average detector is selected. If the Average type is set to Auto, Power Averaging is selected. Other choices for the detector or Average type will usually cause measurement inaccuracy.

What is band/interval density?

On frequency domain traces, the average density across a band is the total band power divided by the bandwidth over which it is measured.

On time domain traces, interval density is the average power in the interval divided by the noise bandwidth of the RBW of the trace.

Marker Function

Marker Function Off

Turns off band functions for the selected marker.

Key Path	Marker Function
Example	:CALC:MARK:FUNC OFF turns off marker functions for marker 1
Notes	See the description under the “Marker” on page 1039 key, above.
Dependencies	Fixed markers: It is not possible to change the Band Function for a Fixed marker; so all of the Band Function keys are grayed out for a Fixed marker, including Off
Couplings	Turning off the marker function has no effect on the band span nor does it turn the marker off.
Initial S/W Revision	Prior to A.02.00

Band Adjust

Opens a menu that lets you set the width or left or right edges of the band.

It is legal to change the width of the band even if there is no marker function on. Generally this can only happen by sending the SCPI command since access to the menu is restricted if no marker function is on.

Key Path	Marker Function
Dependencies	If the marker is Fixed, Band Adjust is grayed out. If the marker function is Off, Band Adjust is grayed out.
Couplings	If any of the Band Adjust functions are the active function, the wings and arms of the selected marker display in green; otherwise they display in white.
Initial S/W Revision	Prior to A.02.00

Band/Interval Span

Sets the width of the span for the selected marker.

It is legal to change the width of the band even if there is no marker function on. Generally this can only happen by sending the SCPI command since access to the menu is restricted if no marker function is on.

In the table below, $\text{sweep_width} = \max(1, \text{sweep_points} - 1)$ and sweep_points is the number of sweep points, set in the **Sweep** menu.

Key Path	Marker Function, Band Adjust
Remote Command	:CALCulate:MARKer [1] 2 3 4 5 6 7 8 9 10 11 12 :FUNCTION: BAND:SPAN <freq> :CALCulate:MARKer [1] 2 3 4 5 6 7 8 9 10 11 12 :FUNCTION: BAND:SPAN?

Example	:CALC:MARK12:FUNC:BAND:SPAN 20 MHz sets the band span of marker 12 to 20 MHz :CALC:MARK:FUNC:BAND:SPAN? queries the band span of Marker 1
Notes	Units are those of the trace's domain, Hz for frequency domain, s for time domain.
Notes	<p>Sending this command selects the subopcoded marker</p> <p>The unit of the parameter must match the current domain of the trace the selected marker is on, or an invalid suffix error will be generated. If no unit is sent the fundamental unit for the trace domain will be used (Hz for freq domain traces, s for time domain traces).</p> <p>Note that all the values provided in this table are only valid for frequency domain traces. If the current domain of the trace is time domain, values and unit will be different. In frequency domain, the Preset value is dependant on the frequency range of the instrument. The default value 1.3245 GHz is appropriate only if the instrument is a 26.5 GHz instrument (Option 526). In a 26.5 GHz Instrument, the default span is 26.49 GHz, so 5% of the span corresponds to 1.3245 GHz.</p>
Couplings	<p>Changing the Band/Interval Span necessarily changes the Band/Interval Left and Band/Interval Right values</p> <p>Band/Interval Span is set to 0 when the marker is turned off</p> <p>Band/Interval Span is set to 5% of span when any marker function is turned on if and only if it is zero at that time</p>
Preset	If 0, set to 5% of span, when a marker function is turned on
State Saved	Saved in Instrument State
Min	0 Hz
Max	Infinity. Unlike legacy analyzers, where the markers were forced to be on screen, X-Series marker values are not limited and do not clip
Backwards Compatibility SCPI	:CALCulate:MARKer[1] 2 3 4:X:SPAN
Initial S/W Revision	Prior to A.02.00

Band/Interval Left

Sets the left edge frequency or time for the band of the selected marker. The right edge is unaffected.

It is legal to change the width of the band even if there is no marker function on. Generally this can only happen by sending the SCPI command since access to the menu is restricted if no marker function is on.

In the table below, $\text{sweep_width} = \max(1, \text{sweep_points} - 1)$ and sweep_points is the number of sweep points, set in the **Sweep** menu.

Key Path	Marker Function, Band Adjust
----------	-------------------------------------

Marker Function

Remote Command	<pre>:CALCulate:MARKer[1] 2 3 4 5 6 7 8 9 10 11 12:FUNCTION: BAND:LEFT <freq></pre> <pre>:CALCulate:MARKer[1] 2 3 4 5 6 7 8 9 10 11 12:FUNCTION: BAND:LEFT?</pre>
Example	<pre>:CALC:MARK12:FUNC:BAND:LEFT 20 GHz</pre> sets the left edge of the band span of marker 12 to 20 GHz <pre>:CALC:MARK:FUNC:BAND:LEFT?</pre> queries the band span of Marker 1
Notes	Units are those of the trace's domain, Hz for frequency domain, s for time domain. When the left edge is moved, the right edge stays anchored; thus, the marker's frequency will change.
Notes	<p>Sending this command selects the subopcoded marker</p> <p>The unit of the parameter must match the current domain of the trace the selected marker is on, or an invalid suffix error will be generated. If no unit is sent the fundamental unit for the trace domain will be used (Hz for freq domain traces, s for time domain traces).</p> <p>Note that all the values provided in this table are only valid for frequency domain traces. If the current domain of the trace is time domain, values and unit will be different. In frequency domain, the Preset value is dependant on the frequency range of the instrument. The default value 1.3245 GHz is appropriate only if the instrument is a 26.5 GHz instrument (Option 526). In a 26.5 GHz Instrument, the default span is 26.49 GHz, so 5% of the span corresponds to 1.3245 GHz.</p>
Couplings	<p>Changing the Band/Interval Left necessarily changes the Band/Interval Span and Band/Interval Center values</p> <p>Band/Interval Span is set to 0 when the marker is turned off so that means Band/Interval Left is set to the center value at this time</p> <p>Band/Interval Span is set to 5% of span when any marker function is turned on if and only if it is zero at that time</p>
Preset	If 0, Band/Interval Span is set to 5% of span, when a marker function is turned on, which affects Band/Interval Left
State Saved	Saved in Instrument State
Min	0 Hz
Max	Infinity. Unlike legacy analyzers, where the markers were forced to be on screen, X-Series marker values are not limited and do not clip
Backwards Compatibility SCPI	<pre>:CALCulate:MARKer[1] 2 3 4:X:STARt</pre> <p>(This legacy command was used to control the Reference marker in Delta Pair/Band Pair mode, and is aliased to the new command.)</p>
Initial S/W Revision	Prior to A.02.00

Band/Interval Right

Sets the right edge frequency or time for the band of the selected marker. The left edge is unaffected

In the table below, $\text{sweep_width} = \max(1, \text{sweep_points} - 1)$ and sweep_points is the number of sweep points, set in the **Sweep** menu.

It is legal to change the width of the band even if there is no marker function on. Generally this can only happen by sending the SCPI command since access to the menu is restricted if no marker function is on.

Key Path	Marker Function, Band Adjust
Remote Command	:CALCulate:MARKer [1] 2 3 4 5 6 7 8 9 10 11 12 :FUNction: BAND:RIGHT <freq> :CALCulate:MARKer [1] 2 3 4 5 6 7 8 9 10 11 12 :FUNction: BAND:RIGHT?
Example	:CALC:MARK12:FUNC:BAND:RIGHT 20 GHz sets the right edge of the band span of marker 12 to 20 GHz :CALC:MARK:FUNC:BAND:RIGHT? queries the band span of Marker 1
Notes	Units are those of the trace's domain, Hz for frequency domain, s for time domain. When the right edge is moved, the left edge stays anchored; thus, the marker's frequency will change.
Notes	Sending this command selects the subcoded marker The unit of the parameter must match the current domain of the trace the selected marker is on, or an invalid suffix error will be generated. If no unit is sent the fundamental unit for the trace domain will be used (Hz for freq domain traces, s for time domain traces). Note that all the values provided in this table are only valid for frequency domain traces. If the current domain of the trace is time domain, values and unit will be different. In frequency domain, the Preset value is dependant on the frequency range of the instrument. The default value 1.3245 GHz is appropriate only if the instrument is a 26.5 GHz instrument (Option 526). In a 26.5 GHz Instrument, the default span is 26.49 GHz, so 5% of the span corresponds to 1.3245 GHz.
Couplings	Changing the Band/Interval Right necessarily changes the Band/Interval Span and Band/Interval Center values Band/Interval Span is set to 5% of span when any marker function is turned on if and only if it is zero at that time
Preset	If 0, Band/Interval Span is set to 5% of span, when a marker function is turned on, which affects Band/Interval Right
State Saved	Saved in Instrument State
Min	0 Hz
Max	Infinity. Unlike legacy analyzers, where the markers were forced to be on screen, X-Series marker values are not limited and do not clip

Marker Function

Backwards Compatibility SCPI	:CALCulate:MARKer[1] 2 3 4:X:STOP (This legacy command was used to control the Delta marker in Delta Pair/Band Pair mode, and is aliased to the new command. For compatibility. Note that if you were using the old command for Band Power measurements it will work just fine.)
Initial S/W Revision	Prior to A.02.00

Measure at Marker

This key and all the keys in this menu only appear with Option EMC installed and licensed.

This key opens up a menu which contains the Measure at Marker functions. This key only appears with option EMC installed.

Key Path	Marker Function
Initial S/W Revision	A.02.00

Measure at Marker

When this key is pressed, the analyzer executes one Measure at Marker function and then returns. Measure at Marker goes to the frequency of the selected marker and takes a reading with each of the three detectors selected in the Detectors menu, using the dwell times specified there, then displays the readings in a window on the display, using the current Y-Axis Unit.

When the Measure at Marker is complete, the analyzer restores all settings to their pre-Measure-at-Marker values and normal sweeps resume.

Key Path	Marker Function, Measure at Marker
Remote Command	:CALCulate:MARKer[1] 2 3 4 5 6 7 8 9 10 11 12:FUNction:MAMarker?
Example	:CALC:MARK2:FUNC:MAM? Performs a Measure at Marker function at Marker 2's current frequency and, when completed, returns the results of the measure at marker window in a query

Notes	<p>This query command returns comma separated values for the 3 specified detectors and the frequency value of the marker. If a Detector is off or if no measurement has yet completed, -999.0 will be returned. This can happen, for example, if you are operating with too large a value of (span/sweep points) and the Measure at Marker function does not execute but instead puts up the advisory message, “Span per point too large, narrow span or increase RBW or number of points” (see below).</p> <p>The size of the return data array is fixed at 4. The elements are:</p> <ol style="list-style-type: none"> 1. Detector 1 value (if off, -999.0 for backwards compatibility) 2. Detector 2 value (if off, -999.0 for backwards compatibility) 3. Detector 3 value (if off, -999.0 for backwards compatibility) 4. Frequency of Marker <p>If a sweep is in process when this function executes it aborts, and restarts after the function is complete.</p> <p>This command is not backwards compatible with the E7400 and PSA option 239 so the Backwards Compatibility command is included.</p>
Dependencies	<p>If BW & Avg Type is in Autocoupled state, the (up to three) measurements taken by Measure at Marker are taken with Auto Coupled settings for the functions in the BW menu, even if those functions are in manual.</p>
Couplings	<p>If the specified Marker is not on, the analyzer turns it on at center of screen and does a peak search before performing the function.</p>
Status Bits/OPC dependencies	<p>OPC goes true when the measurement is complete</p>
Backwards Compatibility SCPI	<p>:MEASure:EMI:MARKer[1] 2 3 4 5 6 7 8 9 10 11 12?</p> <p>(Performs a Measure at Marker function at specified marker’s current frequency and returns the results)</p>
Initial S/W Revision	<p>A.02.00</p>

Measure at Marker presents its information in a separate window which normally appears in the upper right of the display but can be repositioned to the upper left.

Marker Function

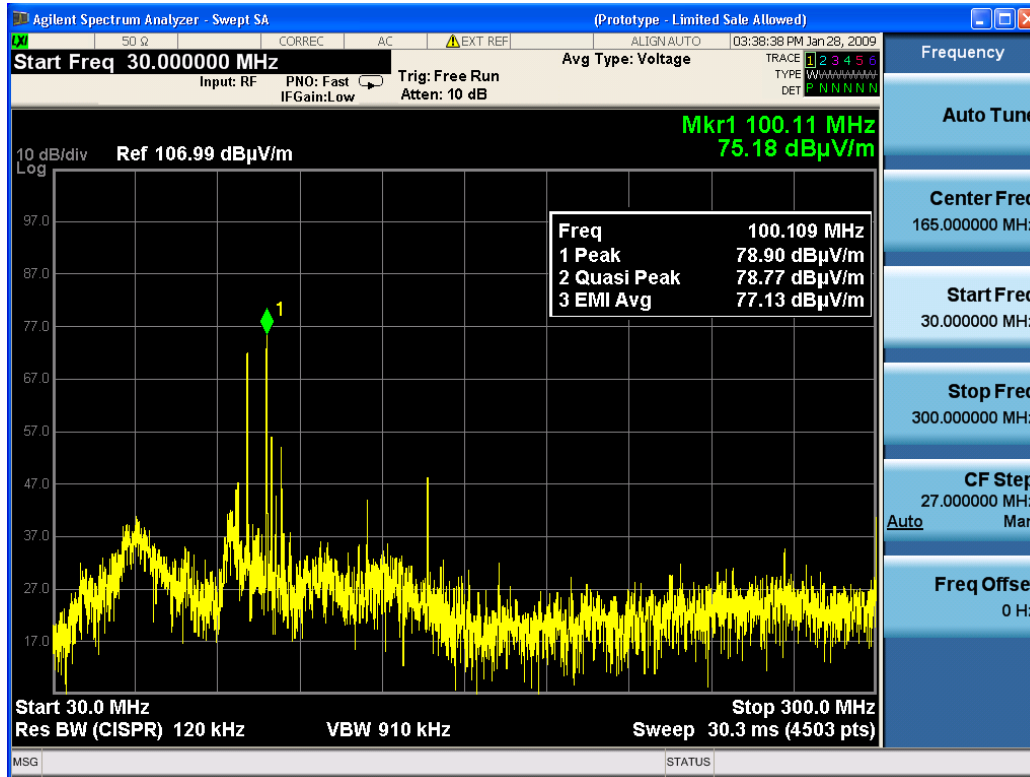

The Measure at Marker box shows the detector name for the selected detectors and “Off” for those not selected. The names used are:

Name	Detector
Normal	Normal
Peak	Peak
Sample	Sample
Neg Peak	Negative Peak
RMS	Average detector with Power Average (RMS)
Log Avg	Average detector with Log-Pwr Average
VoltageAvg	Average detector with Voltage Average
Quasi Peak	Quasi Peak
EMI Avg	EMI Average
RMS Avg	RMS Average

The marker frequency is shown in the “Freq” field. The measured value is shown for all detectors except those that are “Off.” For these, --- is displayed. The current Y-Axis unit is used, and the precision that is used for the detector value displays is exactly the same as for the Marker. The precision used for the Frequency display is six significant digits.

The sequence of steps in the measurement is as follows:

- Any sweep in progress is aborted.
- If in Zero Span, the Center Frequency is used as the frequency at which to take the reading, since in Zero Span, all markers are by definition at the Center Frequency
- If not in Zero Span:
 - If the selected marker is Off, it is first turned on in the center of the screen and a peak search performed.
 - If the selected marker is on, but offscreen, it is first moved to the center of the screen and a peak search performed. .
 - A frequency “zoom” function is performed to determine the frequency of the selected marker to the required precision. If you are operating with too large a value of (span/sweep points) then the Measure at Marker window will not display, but instead an advisory message, “Span per point too large, narrow span or increase RBW or number of points”. This means you have chosen a combination of RBW, span and sweep points that makes each trace point much wider than the RBW, so that the trace point in which the signal appears is an inadequately precise measure of its frequency—for example, with a 30 MHz to 1000 MHz span, 601 trace points and 120 kHz RBW, each trace point is 13 times as wide as the RBW. In this case, a SCPI query of the results will yield -999 dBm for each detector.
 - If the zoom is successful, the analyzer goes to zero span at this frequency
- Each detector is then read in successive single-point zero span sweeps, using a sweep time equal to the specified dwell time. The value displayed by Measure at Marker represents the maximum value output by the detector during the dwell time Autocoupled bandwidth and average type settings are used for each detector unless the **BW & Avg Type** key is set to **As Set**, in which case the current bandwidth and average type settings are used.
- Each result is then displayed in the measure at marker window as it becomes available.
- The analyzer returns to its pre-Measure at Marker span and settings after executing a Measure at Marker function, including Bandwidth, Avg Type, and EMC Std - regardless of the setting of **BW & Avg Type**
- Finally, if the sweep had to be aborted, the aborted sweep is restarted.

While the function is executing, all the fields except Freq show --- for their values until the measurement is complete for that detector. As each detector is read, an informational message is displayed in the status line, for example,

Measuring with detector 1 (Peak) with RBW=120 kHz

After the last detector, the status line is cleared.

Meas at Marker Window

This key opens a menu which controls the Measure at Marker window.

Key Path	Marker Function, Measure at Marker
----------	---

Marker Function

Readback	In square brackets, the state of the window then the window position, separated by commas, as [On, Left]
Initial S/W Revision	A.02.00

Window

This key turns the Measure at Marker window on and off. It turns on automatically when Measure at Marker is initiated and turns off on a Preset. If the Window is turned on without a Measure at Marker result, --- is displayed for each result for which the detector is not “Off”.

Key Path	Marker Function, Measure at Marker, Meas at Marker Window
Remote Command	:DISPlay:WINDow:MAMarker[:STATe] ON OFF 1 0 :DISPlay:WINDow:MAMarker[:STATe]?
Example	:DISP:WIND:MAM ON
Couplings	The window turns on automatically when Measure at Marker is initiated and turns off on a Preset.
Preset	Off
State Saved	Saved in instrument state
Readback Text	On Off
Initial S/W Revision	A.02.00

Position

This key controls the placement of the Measure at Marker window on the display.

Key Path	Marker Function, Measure at Marker, Meas at Marker Window
Remote Command	:DISPlay:WINDow:MAMarker:POSition LEFT RIGHT :DISPlay:WINDow:MAMarker:POSition?
Example	:DISP:WIND:MAM:POS RIGH
Preset	Right
State Saved	Saved in instrument state
Readback Text	Left Right
Initial S/W Revision	A.02.00

Detectors

This key opens up a menu that allows you to configure the detectors to be used for the Measure at Marker reading. Any of the analyzer’s detectors can be used for each of the three detectors, or any of the three can be turned off. The dwell time for each detector is also settable.

When performing a Meas at Marker, the dwell time settings that you select will depend on the characteristics of the emission you are measuring. The default dwell time (200 ms) should work well for

typical EUT emissions, but sometimes you will encounter emissions for which the defaults are not optimal. This is especially the case for emissions that vary slowly over time or have a slow repetition rate. By lengthening the dwell times you can increase the likelihood of accurately measuring these low repetition rate signals.

When Measure at marker is activated, the receiver makes a zero span measurement for each of the (up to) three detectors selected, using the Dwell Time set for each detector. If the signal's repetition period is greater than 200 ms (the default setting), the dwell time should be increased to capture at least two and preferably more repetitions of the signal. Additionally, if you do not need or do not wish to use a detector to make a measurement, that specific detector may be turned off.

If the Measure at Marker window is being displayed, and one of the detectors is changed, any value being displayed for that detector changes to “---“ until the next successful reading from that detector.

Key Path	Marker Function, Measure at Marker,
Remote Command	:CALCulate:MAMarker:DETECTOR [1] 2 3 OFF NORMAL AVERAGE POSITIVE SAMPLE NEGATIVE QPEAK EVERAGE RAVERAGE :CALCulate:MAMarker:DETECTOR [1] 2 3?
Example	:CALC:MAM:DET2 QPE Sets the detector for measure at marker detector 2 to Quasi peak :CALC:MAM:DET OFF Sets the detector for measure at marker detector 1 to Off
State Saved	Saved in instrument state
Initial S/W Revision	A.02.00

Key Path	Marker Function, Measure at Marker,
Remote Command	:CALCulate:MAMarker:DETECTOR [1] 2 3:DWELL <dwell time> :CALCulate:MAMarker:DETECTOR [1] 2 3:DWELL?
Example	:CALC:MAM:DET2:DWELL 500 ms Sets the detector for measure at marker detector 2 to dwell for 500 ms
State Saved	Saved in instrument state
Backwards Compatibility SCPI	[:SENSE]:EMI:MEASURE:DETECTOR:DWELL <dwell time> ! Sets all of the detectors dwell time to the specified amount
Initial S/W Revision	A.02.00

Detector 1

This menu lets you select the detector to be used for Detector 1, or turn Detector 1 off. This is a 1-of-N menu that shows the normal list of detectors, but with the “Auto” key replaced by “Off”.

Key Path	Marker Function, Measure at Marker, Detectors
----------	---

Marker Function

Remote Command	See “Detectors” on page 1072.
Example	:CALC:MAM:DET QPE Sets the detector for measure at marker detector 1 to Quasi peak :CALC:MAM:DET OFF Sets the detector for measure at marker detector 1 to Off
Preset	Peak
State Saved	Saved in instrument state
Readback Text	Detector name
Initial S/W Revision	A.02.00

Detector 2

This menu lets you select the detector to be used for Detector 2, or turn Detector 2 off. This is a 1-of-N menu that shows the normal list of detectors, but with the “Auto” key replaced by “Off”.

Key Path	Marker Function, Measure at Marker, Detectors
Remote Command	See “Detectors” on page 1072.
Example	:CALC:MAM:DET2 QPE Sets the detector for measure at marker detector 2 to Quasi peak :CALC:MAM:DET2 OFF Sets the detector for measure at marker detector 2 to Off
Preset	Quasi Peak
State Saved	Saved in instrument state
Readback Text	Detector name
Backwards Compatibility SCPI	[:SENSe]:EMI:MEASure:DETEctor:QPEak[:STATe] OFF ON 0 1 ! If sent with On as a parameter, sets detector 2 to Quasi Peak ! If sent with Off as a parameter, sets detector 2 to Off
Initial S/W Revision	A.02.00

Detector 3

This menu lets you select the detector to be used for Detector 3, or turn Detector 3 off. This is a 1-of-N menu that shows the normal list of detectors, but with the “Auto” key replaced by “Off”.

Key Path	Marker Function, Measure at Marker, Detectors
Remote Command	See “Detectors” on page 1072.

Example	:CALC:MAM:DET3 QPE Sets the detector for measure at marker detector 1 to Quasi peak :CALC:MAM:DET3 OFF Sets the detector for measure at marker detector 1 to Off
Preset	EMI Average
State Saved	Saved in instrument state
Readback Text	Detector name
Backwards Compatibility SCPI	[:SENSe]:EMI:MEASure:DETECTOR:AVERAge[:STATe] OFF ON 0 1 ! If sent with On as a parameter, sets detector 3 to EMI Average ! If sent with Off as a parameter, sets detector 3 to Off
Initial S/W Revision	A.02.00

Detector 1 Dwell Time

This is the time specified by the user to dwell while taking the measurement for detector 1. The minimum allowed dwell time is based on the current detector. If “Off” is selected for detector 1, this key is grayed out and shows 200 ms.

Key Path	Marker Function, Measure at Marker, Detectors
Remote Command	See “ Detectors ” on page 1072.
Example	:CALC:MAM:DET:DWEL 400 ms Sets the dwell time for detector 1 to 400 ms
Preset	200 ms
State Saved	Saved in instrument state
Min	1 ms
Max	60 s
Initial S/W Revision	A.02.00
Default Unit	s

Detector 2 Dwell Time

This is the time specified by the user to dwell while taking the measurement for detector 2. The minimum allowed dwell time is based on the current detector. If “Off” is selected for detector 2, this key is grayed out and shows 200 ms.

Key Path	Marker Function, Measure at Marker, Detectors
Remote Command	See “ Detectors ” on page 1072.

Marker Function

Example	:CALC:MAM:DET2:DWEL 400 ms Sets the dwell time for detector 2 to 400 ms
Preset	200 ms
State Saved	Saved in instrument state
Min	1 ms
Max	60 s
Initial S/W Revision	A.02.00
Default Unit	s

Detector 3 Dwell Time

This is the time specified by the user to dwell while taking the measurement for detector 3. The minimum allowed dwell time is based on the current detector. If “Off” is selected for detector 3, this key is grayed out and shows 200 ms.

Key Path	Marker Function, Measure at Marker, Detectors
Remote Command	See “Detectors” on page 1072 .
Example	:CALC:MAM:DET3:DWEL 400 ms Sets the dwell time for detector 1 to 400 ms
Preset	200 ms
State Saved	Saved in instrument state
Min	1 ms
Max	60 s
Initial S/W Revision	A.02.00
Default Unit	s

BW & Avg Type

This key controls the type of bandwidth and average type coupling used in Measure at Marker.

If set to “Autocoupled”, then the RBW and Average Type are selected by the instrument during the Measure at Marker function, according to the normal Autocouple rules, regardless of whether RBW and Average Type are currently in Auto. If set to “As Set”, then the current value for RBW and Average Type are used (which of course, could also be “Auto”).

Here are the details of the two modes:

If **BW & Avg Type** is set to **Autocoupled**, **Measure at Marker** behaves as follows:

1. The **EMC Std** changes to CISPR if any of the CISPR detectors (EMI Avg, RMS Avg, QPD) becomes selected; for all other detectors, the value of **EMC Std** that existed before Measure at Marker is used.
2. **RBW** autocouples throughout Measure at Marker, even if **RBW** is set to **Manual**. The autocouple

rules are based on whatever the instantaneous setting of EMC Std, Span, and Center Freq are.

If **BW & Avg Type** is set to **As Set, Measure at Marker** behaves as follows:

1. The **EMC Std** never changes; so if it is set to **None** it stays at **None** throughout, even if one of the CISPR detectors is selected.
2. If **RBW** is set to **Auto**, then **RBW** autocouples throughout Measure at Marker. The autocouple rules are based on whatever the setting of EMC Std, Span, and Center Freq are.
3. If **RBW** is set to **Manual**, the RBW never changes at all throughout Measure at Marker, it stays at the value to which it was set before Measure at Marker began.

The analyzer returns to its pre-Measure at Marker span and settings after executing a Measure at Marker function, including Bandwidth, Avg Type, and EMC Std.

It is important to note that, when RBW is coupled to Frequency, as it is when **EMC Std** is anything but “None”, for all EMI measurements, the frequency it is coupled to for Measure at Marker is the MARKER frequency, not the Center Frequency.

Key Path	Marker Function, Measure at Marker
Remote Command	:CALCulate:MAMarker:COUpling ON OFF 1 0 :CALCulate:MAMarker:COUpling?
Example	:CALC:MAM:COUP ON
Preset	Autocoupled
State Saved	Saved in instrument state
Readback Text	Autocoupled As Set
Initial S/W Revision	A.02.00

Center Presel On/Off

This key controls the automatic centering of the preselector for the Measure at Marker function.

When Center Presel is On, the first step in performing the Measure at Marker function is to perform a Presel Center. This is not performed if the microwave preselector is off, or the selected marker’s frequency is below Band 1. If the function is not performed, no message is generated.

Key Path	Marker Function, Measure at Marker
Remote Command	:CALCulate:MAMarker:PCENter ON OFF 1 0 :CALCulate:MAMarker:PCENter?
Example	:CALC:MAM:PCEN ON
Dependencies	Blank in models that do not include a preselector, such as option 503. If the SCPI is sent in these instruments, it is accepted without error, and the query always returns 0.
Preset	On

Marker Function

Backwards Compatibility SCPI	[:SENSE]:EMI:MEASure:PCENter[:STATE] OFF ON 0 1 [:SENSE]:EMI:MEASure:PCENter[:STATE]?
Initial S/W Revision	A.02.00

Marker To

The Marker -> key accesses menu keys that can copy the current marker value into other instrument parameters (for example, Center Freq). The currently selected marker is made the active function on entry to this menu (if the currently selected marker is not on when you press this front panel key, it will be turned on at the center of the screen as a normal type marker and then made the active function).

The **Marker ->** (or Marker To) feature is used to quickly assign a marker's x- or y-axis value to another parameter. For example, if a marker's x-axis value is 500 MHz and y-axis value is -20 dBm, pressing **Mkr -> CF** would assign 500 MHz to **Center Freq** and pressing **Mkr ->Ref Lvl** would assign -20 dBm to **Ref Level**.

Key Path	Front-panel key
Notes	All Marker To functions executed from the front panel use the selected marker's values, while all Marker To remote commands specify in the command which marker's value to use. Consistent with other remote marker commands, sending a Marker To remote command will never change which marker is selected.
Initial S/W Revision	Prior to A.02.00

Mkr->CF

Sets the center frequency of the analyzer to the frequency of the selected marker. The marker stays at this frequency, so it moves to the center of the display. In delta marker mode, this function sets the center frequency to the x-axis value of the delta marker. When the frequency scale is in log mode, the center frequency is not at the center of the display.

If the currently selected marker is not on when this key is pressed, it will be turned on at the center of the screen as a normal type marker.

Key Path	Marker ->
Remote Command	:CALCulate:MARKer [1] 2 3 4 5 6 7 8 9 10 11 12 [:SET] :CENTer
Example	CALC:MARK2:CENT sets the CF of the analyzer to the value of marker 2.
Notes	Sending this command selects the subopcoded marker If specified marker is off, this command will turn it on at the center of the screen as a normal type marker.
Dependencies	This function is not available (key is grayed out) when x-axis is the time domain
Couplings	All the usual couplings associated with setting Center Frequency apply (see the Frequency Section).
Initial S/W Revision	Prior to A.02.00

Marker To

Mkr->CF Step

Sets the center frequency (CF) step size of the analyzer to the marker frequency, or in a delta-marker mode, to the frequency difference between the delta and reference markers.

If the currently selected marker is not on when this key is pressed, it will be turned on at the center of the screen as a normal type marker.

Key Path	Marker ->
Remote Command	:CALCulate:MARKer [1] 2 3 4 5 6 7 8 9 10 11 12 [:SET] :STEP
Example	CALC:MARK1:STEP sets the CF step to the value (or delta value) of marker 1.
Notes	Sending this command selects the subopcoded marker If specified marker is off, this command will turn it on at the center of the screen as a normal type marker.
Dependencies	This function is not available (key is grayed out) when x-axis is the time domain
Couplings	All the usual couplings associated with setting CF Step apply (see “FREQ Channel” on page 959).
Initial S/W Revision	Prior to A.02.00

Mkr->Start

Changes the start frequency to the frequency of the selected marker. The marker stays at this frequency, so it moves to the left edge of the display. In delta marker mode, this function sets the start frequency to the x-axis value of the delta marker.

If the currently selected marker is not on when this key is pressed, it will be turned on at the center of the screen as a normal type marker.

Key Path	Marker ->
Remote Command	:CALCulate:MARKer [1] 2 3 4 5 6 7 8 9 10 11 12 [:SET] :START
Example	CALC:MARK1:STAR sets the start frequency to the value (or delta value) of marker 1.
Notes	Sending this command selects the subopcoded marker If specified marker is off, this command will turn it on at the center of the screen as a normal type marker.
Dependencies	This function is not available (key is grayed out) when x-axis is the time domain
Couplings	All the usual couplings associated with setting Start Frequency apply.
Initial S/W Revision	Prior to A.02.00

Mkr->Stop

Changes the stop frequency to the frequency of the selected marker. The marker stays at this frequency, so it moves to the right edge of the display. In delta marker mode, this function sets the stop frequency to the x-axis value of the delta marker.

If the currently selected marker is not on when this key is pressed, it will be turned on at the center of the screen as a normal type marker.

Key Path	Marker ->
Remote Command	:CALCulate:MARKer [1] 2 3 4 5 6 7 8 9 10 11 12 [:SET] :STOP
Example	CALC:MARK3:STOP sets the stop frequency to the value (or delta value) of marker 3.
Notes	Sending this command selects the subcoded marker If specified marker is off, this command will turn it on at the center of the screen as a normal type marker.
Dependencies	This function is not available (key is grayed out) when x-axis is the time domain
Couplings	All the usual couplings associated with setting Stop Frequency apply.
Initial S/W Revision	Prior to A.02.00

MkrΔ->Span

Sets the start and stop frequencies to the values of the delta markers. That is, it moves the lower of the two marker frequencies to the start frequency and the higher of the two marker frequencies to the stop frequency. The marker mode is unchanged and the two markers (delta and reference) end up on opposite edges of the display.

Key Path	Marker ->
Remote Command	:CALCulate:MARKer [1] 2 3 4 5 6 7 8 9 10 11 12 [:SET] :DEL Ta:SPAN
Example	CALC:MARK2:DELT:SPAN sets the start and stop frequencies to the values of marker 2 and its reference marker.
Notes	Sending this command selects the subcoded marker
Dependencies	This function is only available when the selected marker is a delta marker. Otherwise the key is grayed out. In addition, this function is not available when x-axis is the time domain
Couplings	All the usual couplings associated with setting Span apply (see “Span ” on page 1173).
Backwards Compatibility SCPI	:CALCulate:MARKer[1] 2 3 4 5 6 7 8 9 10 11 12[:SET]:SPAN

Marker To

Initial S/W Revision	Prior to A.02.00
----------------------	------------------

Mkr Δ ->CF

Sets the center frequency to the frequency difference between the selected marker and its reference marker. The marker is then changed to a Normal marker and placed at the center of span.

Key Path	Marker ->
Remote Command	:CALCulate:MARKer [1] 2 3 4 5 6 7 8 9 10 11 12 [:SET] :DEL Ta:CENTer
Example	CALC:MARK2:CENt sets the CF of the analyzer to the value of marker 2.
Notes	Sending this command selects the subcoded marker
Dependencies	This function is only available when the selected marker is a delta marker. Otherwise the key is grayed out. In addition, this function is not available when x-axis is the time domain
Initial S/W Revision	Prior to A.02.00

Mkr->Ref Lvl

Sets the reference level to the amplitude value of the selected marker, moving the marked point to the reference level (top line of the graticule). The marker's mode (Normal, Delta, Fixed) doesn't matter in this case. For example, given a delta marker, if the delta marker is the selected marker, its amplitude is applied to the reference level. If the reference marker is selected, its amplitude is applied to the reference level.

If the currently selected marker is not on when this key is pressed, it will be turned on at the center of the screen as a normal type marker, and its amplitude applied to the reference level.

Key Path	Marker ->
Remote Command	:CALCulate:MARKer [1] 2 3 4 5 6 7 8 9 10 11 12 [:SET] :RLE Vel
Example	CALC:MARK2:RLEV sets the reference level of the analyzer to the amplitude of marker 2.
Notes	Sending this command selects the subcoded marker If specified marker is off, this command will turn it on at the center of the screen as a normal type marker.
Couplings	All the usual couplings associated with setting Reference Level apply.
Initial S/W Revision	Prior to A.02.00

Meas

The information in this section is common to all measurements. For key and remote command information for a specific measurement, refer to the section that describes the measurement of interest.

Measurements available under the Meas key are specific to the current Mode.

When viewing Help for measurements, note the following:

NOTE Operation for some keys differs between measurements. The information displayed in Help pertains to the current measurement. To see how a key operates in a different measurement, exit Help (press the Cancel Esc key), select the measurement, then reenter Help (press the Help key) and press that key.

Key Path	Front-panel key
Initial S/W Revision	Prior to A.02.00

Remote Measurement Functions

This section contains the following topics:

[“Measurement Group of Commands” on page 1084](#)

[“Current Measurement Query \(Remote Command Only\)” on page 1086](#)

[“Limit Test Current Results \(Remote Command Only\)” on page 1087](#)

[“Data Query \(Remote Command Only\)” on page 1087](#)

[“Calculate/Compress Trace Data Query \(Remote Command Only\)” on page 1087](#)

[“Calculate Peaks of Trace Data \(Remote Command Only\)” on page 1092](#)

[“Format Data: Numeric Data \(Remote Command Only\)” on page 1094](#)

[“Format Data: Byte Order \(Remote Command Only\)” on page 1095](#)

Initial S/W Revision	Prior to A.02.00
----------------------	------------------

Measurement Group of Commands

Measure Commands:

:MEASure:<measurement>[n]?

This is a fast single-command way to make a measurement using the factory default instrument settings. These are the settings and units that conform to the Mode Setup settings (e.g. radio standard) that you have currently selected.

- Stops the current measurement (if any) and sets up the instrument for the specified measurement using the factory defaults
- Initiates the data acquisition for the measurement
- Blocks other SCPI communication, waiting until the measurement is complete before returning results.
- If the function does averaging, it is turned on and the number of averages is set to 10.
- After the data is valid it returns the scalar results, or the trace data, for the specified measurement. The type of data returned may be defined by an [n] value that is sent with the command.

The scalar measurement results will be returned if the optional [n] value is not included, or is set to 1. If the [n] value is set to a value other than 1, the selected trace data results will be returned. See each command for details of what types of scalar results or trace data results are available.

ASCII is the default format for the data output. (Older versions of Spectrum Analysis and Phase Noise mode measurements only use ASCII.) The binary data formats should be used for handling large blocks of data since they are smaller and faster than the ASCII format. Refer to the FORMat:DATA command for more information.

If you need to change some of the measurement parameters from the factory default settings you can set up the measurement with the CONFigure command. Use the commands in the SENSE:<measurement> and CALCulate:<measurement> subsystems to change the settings. Then you can use the READ? command to initiate the measurement and query the results.

If you need to repeatedly make a given measurement with settings other than the factory defaults, you can use the commands in the SENSE:<measurement> and CALCulate:<measurement> subsystems to set up the measurement. Then use the READ? command to initiate the measurement and query results.

Measurement settings persist if you initiate a different measurement and then return to a previous one. Use READ:<measurement>? if you want to use those persistent settings. If you want to go back to the default settings, use MEASure:<measurement>?.

Configure Commands:

Measure Commands:**:CONFigure:<measurement>**

This command stops the current measurement (if any) and sets up the instrument for the specified measurement using the factory default instrument settings. It does not initiate the taking of measurement data unless INIT:CONTInuous is ON. If you change any measurement settings after using the CONFigure command, the READ command can be used to initiate a measurement without changing the settings back to their defaults.

In the Swept SA measurement in Spectrum Analyzer mode the CONFigure command also turns the averaging function on and sets the number of averages to 10 for all measurements.

:CONFigure:NDEFault<measurement> stops the current measurement and changes to the specified measurement. It does not change the settings to the defaults. It does not initiate the taking of measurement data unless INIT:CONTInuous is ON.

The **CONFigure?** query returns the current measurement name.

The **CONFigure:CATalog?** query returns a quoted string of all measurement names in the current mode. For example, "SAN, CHP, OBW, ACP, PST, TXP, SPUR, SEM, LIST".

Fetch Commands:**:FETCh:<measurement>[n]?**

This command puts selected data from the most recent measurement into the output buffer. Use FETCh if you have already made a good measurement and you want to return several types of data (different [n] values, for example, both scalars and trace data) from a single measurement. FETCh saves you the time of re-making the measurement. You can only FETCh results from the measurement that is currently active, it will not change to a different measurement. An error is reported if a measurement other than the current one, is specified.

If you need to get new measurement data, use the READ command, which is equivalent to an INITiate followed by a FETCh.

The scalar measurement results will be returned if the optional [n] value is not included, or is set to 1. If the [n] value is set to a value other than 1, the selected trace data results will be returned. See each command for details of what types of scalar results or trace data results are available. The binary data formats should be used for handling large blocks of data since they are smaller and transfer faster than the ASCII format. (FORMat:DATA)

FETCh may be used to return results other than those specified with the original READ or MEASure command that you sent.

INITiate Commands:

Measure Commands:	
:INITiate:<measurement>	
<p>This command is not available for measurements in all the instrument modes:</p> <ul style="list-style-type: none"> • Initiates a trigger cycle for the specified measurement, but does not output any data. You must then use the FETCh<meas> command to return data. If a measurement other than the current one is specified, the instrument will switch to that measurement and then initiate it. • For example, suppose you have previously initiated the ACP measurement, but now you are running the channel power measurement. If you send INIT:ACP? it will change from channel power to ACP and will initiate an ACP measurement. • Does not change any of the measurement settings. For example, if you have previously started the ACP measurement and you send INIT:ACP? it will initiate a new ACP measurement using the same instrument settings as the last time ACP was run. • If your selected measurement is currently active (in the idle state) it triggers the measurement, assuming the trigger conditions are met. Then it completes one trigger cycle. Depending upon the measurement and the number of averages, there may be multiple data acquisitions, with multiple trigger events, for one full trigger cycle. It also holds off additional commands on GPIB until the acquisition is complete. 	
READ Commands:	
:READ:<measurement>[n]?	
<ul style="list-style-type: none"> • Does not preset the measurement to the factory default settings. For example, if you have previously initiated the ACP measurement and you send READ:ACP? it will initiate a new measurement using the same instrument settings. • Initiates the measurement and puts valid data into the output buffer. If a measurement other than the current one is specified, the instrument will switch to that measurement before it initiates the measurement and returns results. <p>For example, suppose you have previously initiated the ACP measurement, but now you are running the channel power measurement. Then you send READ:ACP? It will change from channel power back to ACP and, using the previous ACP settings, will initiate the measurement and return results.</p> <ul style="list-style-type: none"> • Blocks other SCPI communication, waiting until the measurement is complete before returning the results <p>If the optional [n] value is not included, or is set to 1, the scalar measurement results will be returned. If the [n] value is set to a value other than 1, the selected trace data results will be returned. See each command for details of what types of scalar results or trace data results are available. The binary data formats should be used when handling large blocks of data since they are smaller and faster than the ASCII format. (FORMat:DATA)</p>	

Initial S/W Revision	Prior to A.02.00
----------------------	------------------

Current Measurement Query (Remote Command Only)

This command returns the name of the measurement that is currently running.

Remote Command	:CONFigure?
-----------------------	-------------

Example	CONF?
Initial S/W Revision	Prior to A.02.00

Limit Test Current Results (Remote Command Only)

Queries the status of the current measurement limit testing. It returns a 0 if the measured results pass when compared with the current limits. It returns a 1 if the measured results fail any limit tests.

Remote Command	:CALCulate:CLIMits:FAIL?
Example	CALC:CLIM:FAIL? queries the current measurement to see if it fails the defined limits. Returns a 0 or 1: 0 it passes, 1 it fails.
Initial S/W Revision	Prior to A.02.00

Data Query (Remote Command Only)

Returns the designated measurement data for the currently selected measurement and subopcode.

n = any valid subopcode for the current measurement. See the measurement command results table for your current measurement, for information about what data is returned for the subopcodes.

This command uses the data setting specified by the FORMat:BORDER and FORMat:DATA commands and can return real or ASCII data. (See the format command descriptions under Input/Output in the Analyzer Setup section.)

Remote Command	:CALCulate:DATA [n] ?
Notes	The return trace depends on the measurement. In CALCulate:<meas>:DATA[n], n is any valid subopcode for the current measurement. It returns the same data as the FETCh:<measurement>? query where <measurement> is the current measurement.
Initial S/W Revision	Prior to A.02.00

Calculate/Compress Trace Data Query (Remote Command Only)

Returns compressed data for the currently selected measurement and sub-opcode [n].

n = any valid sub-opcode for that measurement. See the MEASure:<measurement>? command description of your specific measurement for information on the data that can be returned.

The data is returned in the current Y Axis Unit of the analyzer. The command is used with a sub-opcode <n> (default=1) to specify the trace. With trace queries, it is best if the analyzer is not sweeping during the query. Therefore, it is generally advisable to be in Single Sweep, or Update=Off.

This command is used to compress or decimate a long trace to extract and return only the desired data. A typical example would be to acquire N frames of GSM data and return the mean power of the first burst

Meas

in each frame. The command can also be used to identify the best curve fit for the data.

Remote Command	:CALCulate:DATA<n>:COMPRESS? BLOCk CFIT MAXimum MINimum MEAN DMEan RMS RMSCubed SAMP le SDEVIation PPHase [,<soffset>[,<length>[,<roffset>[,<rlimit>]]]]
Example	To query the mean power of a set of GSM bursts: Supply a signal that is a set of GSM bursts. Select the IQ Waveform measurement (in IQ Analyzer Mode). Set the sweep time to acquire at least one burst. Set the triggers such that acquisition happens at a known position relative to a burst. Then query the mean burst levels using, CALC:DATA2:COMP? MEAN,24e-6,526e-6 (These parameter values correspond to GSM signals, where 526e-6 is the length of the burst in the slot and you just want 1 burst.)
Notes	The command supports 5 parameters. Note that the last 4 (<soffset>,<length>,<roffset>,<rlimit>) are optional. But these optional parameters must be entered in the specified order. For example, if you want to specify <length>, then you must also specify <soffset>. See details below for a definition of each of these parameters. This command uses the data in the format specified by FORMat:DATA, returning either binary or ASCII data.
Initial S/W Revision	Prior to A.02.00

- **BLOCk** or block data - returns all the data points from the region of the trace data that you specify. For example, it could be used to return the data points of an input signal over several timeslots, excluding the portions of the trace data that you do not want. (This is x,y pairs for trace data and I,Q pairs for complex data.)
- **CFIT** or curve fit - applies curve fitting routines to the data. <soffset> and <length> are required to define the data that you want. <roffset> is an optional parameter for the desired order of the curve equation. The query will return the following values: the x-offset (in seconds) and the curve coefficients ((order + 1) values).

MIN, MAX, MEAN, DME, RMS, RMSC, SAMP, SDEV and PPH return one data value for each specified region (or <length>) of trace data, for as many regions as possible until you run out of trace data (using <roffset> to specify regions). Or they return the number of regions you specify (using <rlimit>) ignoring any data beyond that.

- **MINimum** - returns the minimum data point (x,y pair) for the specified region(s) of trace data. For I/Q trace data, the minimum magnitude of the I/Q pairs is returned.
- **MAXimum** - returns the maximum data point (x,y pair) for the specified region(s) of trace data. For I/Q trace data, the maximum magnitude of the I/Q pairs is returned.

NOTE MEAN - returns a single value that is the arithmetic mean of the data point values

(in dB/ dBm) for the specified region(s) of trace data. For I/Q trace data, the mean of the magnitudes of the I/Q pairs is returned. See the following equations.

If the original trace data is in dB, this function returns the arithmetic mean of those log values, not log of the mean power which is a more useful value. The mean of the log is the better measurement technique when measuring CW signals in the presence of noise. The mean of the power, expressed in dB, is useful in power measurements such as Channel Power. To achieve the mean of the power, use the RMS option.

Equation 1

Mean Value of Data Points for Specified Region(s)

$$\text{MEAN} = \frac{1}{n} \sum_{X_i \in \text{region}(s)} X_i \quad \text{vsd27-1}$$

where X_i is a data point value, and n is the number of data points in the specified region(s).

Equation 2

Mean Value of I/Q Data Pairs for Specified Region(s)

$$\text{MEAN} = \frac{1}{n} \sum_{X_i \in \text{region}(s)} |X_i| \quad \text{vsd27-2}$$

where $|X_i|$ is the magnitude of an I/Q pair, and n is the number of I/Q pairs in the specified region(s).

- DMEan - returns a single value that is the mean power (in dB/ dBm) of the data point values for the specified region(s) of trace data. See the following equation:

Equation 3

DMEan Value of Data Points for Specified Region(s)

$$\text{DME} = 10 \times \log_{10} \left(\frac{1}{n} \sum_{X_i \in \text{region}(s)} 10^{\frac{X_i}{10}} \right) \quad \text{vsd27-3}$$

- RMS - returns a single value that is the average power on a root-mean-squared voltage scale (arithmetic rms) of the data point values for the specified region(s) of trace data. See the following equation.

NOTE

For I/Q trace data, the rms of the magnitudes of the I/Q pairs is returned. See the following equation.

This function is very useful for I/Q trace data. However, if the original trace data is in dB, this function returns the rms of the log values which is not usually needed.

Meas

Equation 4 RMS Value of Data Points for Specified Region(s)

$$\text{RMS} = \sqrt{\frac{1}{n} \sum_{X_i \in \text{region}(s)} X_i^2}$$

vsd27-4

where X_i is a data point value, and n is the number of data points in the specified region(s).

Equation 5 RMS Value of I/Q Data Pairs for Specified Region(s)

$$\text{RMS} = \sqrt{\frac{1}{n} \sum_{X_i \in \text{region}(s)} X_i X_i^*}$$

vsd27-5

where X_i is the complex value representation of an I/Q pair, X_i^* its conjugate complex number, and n is the number of I/Q pairs in the specified region(s).

Once you have the rms value for a region of trace data (linear or I/Q), you may want to calculate the mean power. You must convert this rms value (peak volts) to power in dBm:

$$10 \times \log[10 \times (\text{rms value})^2]$$

- **SAM**PlE - returns the first data value (x,y pair) for the specified region(s) of trace data. For I/Q trace data, the first I/Q pair is returned.
- **SDE**Viation - returns a single value that is the arithmetic standard deviation for the data point values for the specified region(s) of trace data. See the following equation.

For I/Q trace data, the standard deviation of the magnitudes of the I/Q pairs is returned. See the following equation.

Equation 6 Standard Deviation of Data Point Values for Specified Region(s)

$$\text{SDEV} = \sqrt{\frac{1}{n} \sum_{X_i \in \text{region}(s)} (X_i - \bar{X})^2}$$

vsd27-7

where X_i is a data point value, \bar{X} is the arithmetic mean of the data point values for the specified region(s), and n is the number of data points in the specified region(s).

$$\text{SDEV} = \sqrt{\frac{1}{n} \sum_{X_i \in \text{region}(s)} (|X_i| - \bar{X})^2}$$

vsd27-8

where $|X_i|$ is the magnitude of an I/Q pair, \bar{X} is the mean of the magnitudes for the specified region(s), and n is the number of data points in the specified region(s).

- PPHase - returns the x,y pairs of both rms power (dBm) and arithmetic mean phase (radian) for every specified region and frequency offset (Hz). The number of pairs is defined by the specified number of regions. This parameter can be used for I/Q vector (n=0) in Waveform (time domain) measurement and all parameters are specified by data point in PPHase.

The rms power of the specified region may be expressed as:

$$\text{Power} = 10 \times \log [10 \times (\text{RMS I/Q value})] + 10.$$

The RMS I/Q value (peak volts) is:

$$\sqrt{\frac{1}{n} \sum_{X_i \in \text{region}} X_i X_i^*}$$

vsd27-9

where X_i is the complex value representation of an I/Q pair, X_i^* its conjugate complex number, and n is the number of I/Q pairs in the specified region.

The arithmetic mean phase of the specified region may be expressed as:

$$\frac{1}{n} \sum_{Y_i \in \text{region}} Y_i$$

vsd27-10

where Y_i is the unwrapped phase of I/Q pair with applying frequency correction and n is the number of I/Q pairs in the specified region.

The frequency correction is made by the frequency offset calculated by the arithmetic mean of every specified region's frequency offset. Each frequency offset is calculated by the least square method against the unwrapped phase of I/Q pair.

Sample Trace Data - Constant Envelope

(See below for explanation of variables.)

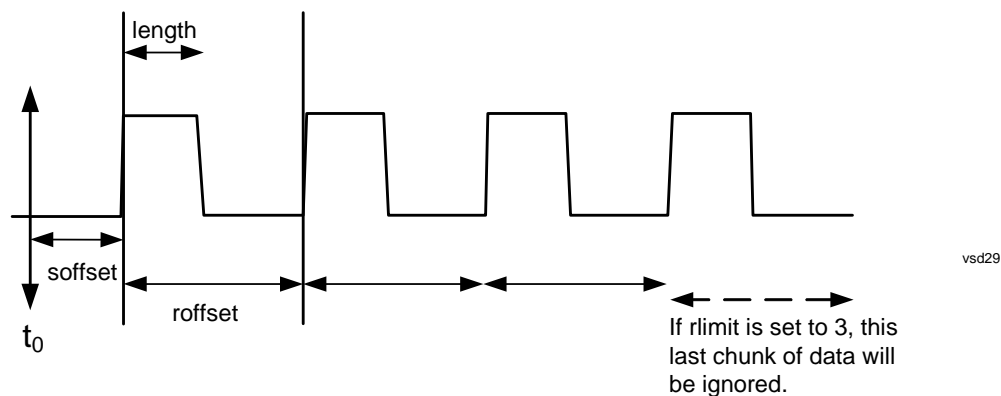

Sample Trace Data - Not Constant Envelope

(See below for explanation of variables.)

Meas

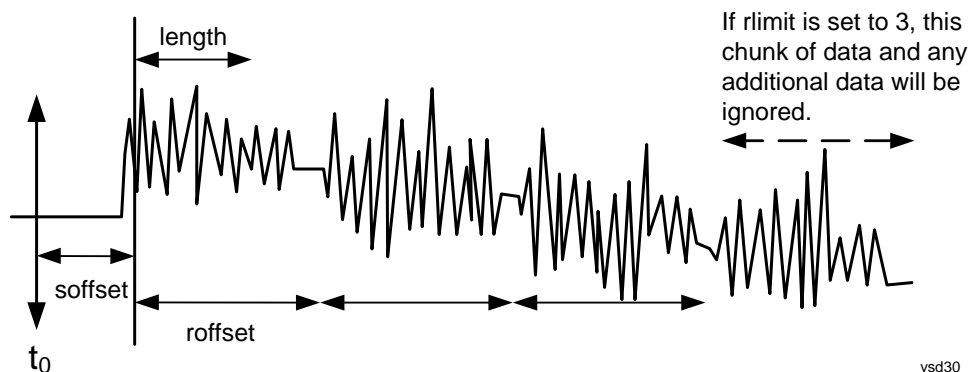

<soffset> - start offset is an optional real number. (It is in seconds for time-domain traces, and is a dimensionless index 0 to Npoints - 1, for frequency-domain traces). It specifies the amount of data at the beginning of the trace that will be ignored before the decimation process starts. It is the time or frequency change from the start of the trace to the point where you want to start using the data. The default value is zero.

<length> - is an optional real number. (It is in seconds for time-domain traces, and is a dimensionless index 0 to Npoints - 1, for frequency-domain traces). It defines how much data will be compressed into one value. This parameter has a default value equal to the current trace length.

<roffset> - repeat offset is an optional real number. (It is in seconds for time-domain traces, and is a dimensionless index 0 to Npoints - 1, for frequency-domain traces). It defines the beginning of the next field of trace elements to be compressed. This is relative to the beginning of the previous field. This parameter has a default value equal to the <length> variable. Note that this parameter is used for a completely different purpose when curve fitting (see CFIT above).

<rlimit> - repeat limit is an optional integer. It specifies the number of data items that you want returned. It will ignore any additional items beyond that number. You can use the Start offset and the Repeat limit to pick out exactly what part of the data you want to use. The default value is all the data.

Calculate Peaks of Trace Data (Remote Command Only)

Returns a list of all the peaks for the currently selected measurement and sub-opcode [n]. The peaks must meet the requirements of the peak threshold and excursion values.

n = any valid sub-opcode for the current measurement. See the MEASure:<measurement> command description of your specific measurement for information on the data that can be returned.

The command can only be used with specific sub-opcodes with measurement results that are trace data. Both real and complex traces can be searched, but complex traces are converted to magnitude in dBm. In many measurements the sub-opcode n=0, is the raw trace data which cannot be searched for peaks. And Sub-opcode n=1, is often calculated results values which also cannot be searched for peaks.

This command uses the data setting specified by the FORMat:BORDER and FORMat:DATA commands and can return real or ASCII data. If the format is set to INT,32, it returns REAL,32 data.

The command has four types of parameters:

- Threshold (in dBm)
- Excursion (in dB)

- Sorting order (amplitude, frequency, time)
- Optional in some measurements: Display line use (all, > display line, < display line)

<p>Remote Command</p>	<p>For Swept SA measurement:</p> <pre>:CALCulate:DATA[1] 2 3 4 5 6 : PEAKs? <threshold>, <excursion> [, AMPLitude FREQuency TIME [, ALL GTDLine LTDLine]]</pre> <p>For most other measurements:</p> <pre>:CALCulate:DATA[1] 2 3 4 5 6 : PEAKs? <threshold>, <excursion> [, AMPLitude FREQuency TIME]</pre>
<p>Example</p>	<p>Example for Swept SA measurement in Spectrum Analyzer Mode:</p> <p>CALC:DATA4:PEAK? -40,10,FREQ,GTDL This will identify the peaks of trace 4 that are above -40 dBm, with excursions of at least 10 dB. The peaks are returned in order of increasing frequency, starting with the lowest frequency. Only the peaks that are above the display line are returned.</p> <p>Query Results 1:</p> <p>With FORMat:DATA REAL,32 selected, it returns a list of floating-point numbers. The first value in the list is the number of peak points that are in the following list. A peak point consists of two values: a peak amplitude followed by its corresponding frequency (or time).</p> <p>If no peaks are found the peak list will consist of only the number of peaks, (0).</p>

<p>Notes</p>	<p><n> - is the trace that will be used</p> <p><threshold> - is the level below which trace data peaks are ignored. Note that the threshold value is required and is always used as a peak criterion. To effectively disable the threshold criterion for this command, provide a substantially low threshold value such as -200 dBm. Also note that the threshold value used in this command is independent of and has no effect on the threshold value stored under the Peak Criteria menu.</p> <p><excursion> - is the minimum amplitude variation (rise and fall) required for a signal to be identified as peak. Note that the excursion value is required and is always used as a peak criterion. To effectively disable the excursion criterion for this command, provide the minimum value of 0.0 dB. Also note that the excursion value used in this command is independent of and has no effect on the excursion value stored under the Peak Criteria menu.</p> <p>Values must be provided for threshold and excursion. The sorting and display line parameters are optional (defaults are AMPLitude and ALL).</p> <p>Note that there is always a Y-axis value for the display line, regardless of whether the display line state is on or off. It is the current Y-axis value of the display line which is used by this command to determine whether a peak should be reported</p> <p>Sorting order:</p> <p>AMPLitude - lists the peaks in order of descending amplitude, with the highest peak first (default if optional parameter not sent)</p> <p>FREQUENCY - lists the peaks in order of occurrence, left to right across the x-axis.</p> <p>TIME - lists the peaks in order of occurrence, left to right across the x-axis.</p> <p>Peaks vs. Display Line:</p> <p>ALL - lists all of the peaks found (default if optional parameter not sent).</p> <p>GTDLIne (greater than display line) - lists all of the peaks found above the display line.</p> <p>LTDLine (less than display line) - lists all of the peaks found below the display line.</p>
<p>Initial S/W Revision</p>	<p>Prior to A.02.00</p>

Format Data: Numeric Data (Remote Command Only)

This command specifies the format of the trace data input and output. It specifies the formats used for trace data during data transfer across any remote port. It affects only the data format for setting and querying trace data for the :TRACe[:DATA], TRACe[:DATA]?, :CALCulate:DATA[n]? and FETCh:SANalyzer[n]? commands and queries.

<p>Remote Command</p>	<p>:FORMat [:TRACe] [:DATA] ASCii INTeger, 32 REAL, 32 REAL, 64</p> <p>:FORMat [:TRACe] [:DATA] ?</p>
------------------------------	---

Notes	<p>The query response is:</p> <p>ASCIi: ASC,8</p> <p>REAL,32: REAL,32</p> <p>REAL,64: REAL,64</p> <p>INTeger,32: INT,32</p> <p>When the numeric data format is REAL or ASCII, data is output in the current Y Axis unit. When the data format is INTeger, data is output in units of m dBm (.001 dBm).</p> <p>Note that the INT,32 format is only applicable to the command, TRACe:DATA. This preserves backwards compatibility for the Swept SA measurement. For all other commands/queries which honor FORMat:DATA, if INT,32 is sent the analyzer will behave as though it were set to REAL,32.</p> <p>The INT,32 format returns binary 32-bit integer values in internal units (m dBm), in a definite length block.</p>
Dependencies	<p>Sending a data format spec with an invalid number (for example, INT,48) generates no error. The analyzer simply uses the default (8 for ASCII, 32 for INTeger, 32 for REAL).</p> <p>Sending data to the analyzer which does not conform to the current FORMat specified, results in an error.</p>
Preset	ASCIi
Initial S/W Revision	Prior to A.02.00

The specs for each output type follow:

ASCIi - Amplitude values are in ASCII, in the current Y Axis Unit, one ASCII character per digit, values separated by commas, each value in the form:

SX.YYYYYEsZZ

Where:

S = sign (+ or -)

X = one digit to left of decimal point

Y = 5 digits to right of decimal point

E = E, exponent header

s = sign of exponent (+ or -)

ZZ = two digit exponent

REAL,32 - Binary 32-bit real values in the current Y Axis Unit, in a definite length block.

REAL,64 - Binary 64-bit real values in the current Y Axis Unit, in a definite length block.

Format Data: Byte Order (Remote Command Only)

This command selects the binary data byte order for data transfer and other queries. It controls whether

Meas

binary data is transferred in normal or swapped mode. This command affects only the byte order for setting and querying trace data for the :TRACe[:DATA], TRACe[:DATA]? , :CALCulate:DATA[n]? and FETCh:SANalyzer[n]? commands and queries.

By definition any command that says it uses FORMat:DATA uses any format supported by FORMat:DATA.

The NORMal order is a byte sequence that begins with the most significant byte (MSB) first, and ends with the least significant byte (LSB) last in the sequence: 1|2|3|4. SWAPped order is when the byte sequence begins with the LSB first, and ends with the MSB last in the sequence: 4|3|2|1.

Remote Command	:FORMat:BORDER NORMAL SWAPped :FORMat:BORDER?
Preset	NORMAL
Initial S/W Revision	Prior to A.02.00

Meas Setup

The Meas Setup key opens a menu of softkeys that allow you to control the most important parameters for the current measurement.

NOTE In the Meas Setup menu you may configure Averaging, by setting the Average Number and the Average Type.

Key Path	Front-panel key
Initial S/W Revision	Prior to A.02.00

Average/Hold Number

Sets the terminal count number N for **Average**, **Max Hold** and **Min Hold** trace types. This number is an integral part of how the average trace is calculated. Basically, increasing N results in a smoother average trace.

See [“More Information” on page 1097](#).

See [“AVER:CLE command” on page 1097](#).

Key Path	Meas Setup
Remote Command	[:SENSe] :AVERage:COUNT <integer> [:SENSe] :AVERage:COUNT?
Couplings	Restarting any of these functions (Average , Max Hold or Min Hold) restarts all of them, as there is only one count.
Preset	100
State Saved	Saved in instrument state
Min	1
Max	10000
Status Bits/OPC dependencies	See “Sweep/Control” on page 1181 for a discussion of the Sweeping, Measuring, Settling and OPC bits, and the Hi Sweep line. All are affected when a sequence is reset.
Initial S/W Revision	Prior to A.02.00

More Information

AVER:CLE command

The AVER:CLE command (below) resets the average/hold count and does an INIT:IMM, which begins

Meas Setup

another set of sweeps when trigger conditions are satisfied. It only does this if an active trace is in Average or Hold type.

Remote Command	[:SENSe] :AVERAge :CLEAr
Example	AVER:COUN 100 AVER:CLE sets the current count (k and K) to 1 and restarts the averaging process.
Notes	When the instrument receives this command it performs an INIT:IMM, if and only if there is an active trace in Max Hold, Min Hold, or Average type.
Initial S/W Revision	Prior to A.02.00
Default Unit	Enter

Average Type

Lets you control the way averaging is done by choosing one of the following averaging scales: log-power (video), power (RMS), or voltage averaging. Also lets you choose Auto Average Type (default).

When performing Trace Averaging, , the equation that is used to calculate the averaged trace depends on the average type. See the descriptions for the keys which select each Average Type (“[Log-Pwr Avg \(Video\)](#)” on page 1100, “[Pwr Avg \(RMS\)](#)” on page 1100, or “[Voltage Avg](#)” on page 1101) for details on these equations.

See “[More Information](#)” on page 1099.

Key Path	Meas Setup
Remote Command	[:SENSe] :AVERAge :TYPE :AUTO OFF ON 0 1 [:SENSe] :AVERAge :TYPE :AUTO?
Preset	ON
State Saved	Saved in Instrument State
Readback line	1-of-N selection as Log-Pwr (Video) for Log-Pwr (Video) Avg Pwr (RMS) for Power Avg Voltage for Voltage
Initial S/W Revision	Prior to A.02.00

Remote Command	[:SENSe] :AVERAge :TYPE RMS LOG SCALAr [:SENSe] :AVERAge :TYPE?
-----------------------	--

Notes	Parameters map to avg types as: RMS = Pwr (RMS) Avg LOG = Log-Pwr (Video) Avg SCALAr = Voltage Avg
Preset	LOG
Backwards Compatibility SCPI	[[:SENSe]:AVERAge:TYPE LINear sets Scalar averaging [:SENSe]:AVERAge:TYPE VOLTage sets Scalar averaging [:SENSe]:AVERAge:TYPE VIDEo sets Log-Power averaging [:SENSe]:AVERAge:TYPE LPOWer sets Log-Power averaging [:SENSe]:AVERAge:TYPE POWEr sets RMS averaging
Initial S/W Revision	Prior to A.02.00

More Information

When you select log-power averaging, the measurement results are the average of the signal level in logarithmic units (decibels). When you select power average (RMS), all measured results are converted into power units before averaging and filtering operations, and converted back to decibels for displaying. Remember: there can be significant differences between the average of the log of power and the log of the average power.

These are the averaging processes within a spectrum analyzer and all of them are affected by this setting:

Trace averaging (see [“Trace/Detector” on page 1211](#)) averages signal amplitudes on a trace-to-trace basis. The average type applies to all traces in Trace Average (it is not set on a trace-by-trace basis).

Average detector (see [“Trace/Detector” on page 1211](#)) averages signal amplitudes during the time or frequency interval represented by a particular measurement point.

Noise Marker (see [“Marker Function” on page 1059](#)) averages signal amplitudes across measurement points to reduce variations for noisy signals.

VBW filtering (see [“BW” on page 945](#)) adds video filtering which is a form of averaging of the video signal.

When **Auto** is selected, the analyzer chooses the type of averaging (see below). When one of the average types is selected manually, the analyzer uses that type regardless of other analyzer settings, and shows **Man** on the **Average Type** softkey.

Auto

Chooses the optimum type of averaging for the current instrument measurement settings.

Key Path	Meas setup, Average Type
Example	AVER:TYPE:AUTO ON
Notes	See Average Type , above

Meas Setup

Couplings	<p>Here are the auto-select rules for Average Type:</p> <p>Auto selects Voltage Averaging if the Detector for any active trace is EMI Average or QPD or RMS Average; otherwise it selects Power (RMS) Averaging if a Marker Function (Marker Noise, Band/Intvl Power) is on, or Detector is set to Man and Average; otherwise if Amplitude, Scale Type is set to Lin it selects Voltage Averaging; otherwise, if the EMC Standard is set to CISPR, it selects Voltage; otherwise Auto selects Log-Power Average.</p> <p>Note that these rules are only applied to active traces. Traces which are not updating do not impact the auto-selection of Average Type.</p>
State Saved	Saved in instrument state
Readback	The type auto-selected is displayed in the readback line on the Average Type key
Initial S/W Revision	Prior to A.02.00

Log-Pwr Avg (Video)

Selects the logarithmic (decibel) scale for all filtering and averaging processes. This scale is sometimes called “Video” because it is the most common display and analysis scale for the video signal within a spectrum analyzer. This scale is excellent for finding CW signals near noise, but its response to noise-like signals is 2.506 dB lower than the average power of those noise signals. This is compensated for in the Marker Noise function.

The equation for trace averaging on the log-pwr scale is shown below, where K is the number of averages accumulated. (In continuous sweep mode, once K has reached the Average/Hold Number, K stays at that value, providing a continuous running average.)

$$\text{New avg} = ((K-1)\text{Old avg} + \text{New data})/K$$

Assumes all values in decibel scale.

Key Path	Meas setup, Average Type
Example	AVER:TYPE LOG
Notes	See ““Average Type” on page 1098”
Couplings	See ““Auto” on page 1099”
Readback	Log-Pwr (Video)
Initial S/W Revision	Prior to A.02.00

Pwr Avg (RMS)

In this average type, all filtering and averaging processes work on the power (the square of the magnitude) of the signal, instead of its log or envelope voltage. This scale is best for measuring the true time average power of complex signals. This scale is sometimes called RMS because the resulting voltage is proportional to the square root of the mean of the square of the voltage.

In the equation for averaging on this scale (below), K is the number of averages accumulated. (In continuous sweep mode, once K has reached the Average/Hold Number, K stays at that value, providing

a running average.)

$$\text{New avg} = 10 \log \left(\frac{1}{K} \left((K-1) \left(\frac{10 \text{Old avg}}{10} \right) + 10 \text{New data} \right) \right)$$

Equation assumes all values are in the decibel scale.

Key Path	Meas setup, Average Type
Example	AVER:TYPE RMS
Notes	See “Average Type” on page 1098
Couplings	See “Auto” on page 1099
Readback	Pwr (RMS)
Initial S/W Revision	Prior to A.02.00

Voltage Avg

In this Average type, all filtering and averaging processes work on the voltage of the envelope of the signal. This scale is good for observing rise and fall behavior of AM or pulse-modulated signals such as radar and TDMA transmitters, but its response to noise-like signals is 1.049 dB lower than the average power of those noise signals. This is compensated for in the **Marker Noise** function.

In the equation for averaging on this scale (below), K is the number of averages accumulated. (In continuous sweep mode, once K has reached the Average/Hold Number, K stays at that value.)

$$\text{New avg} = 20 \log \left(\frac{1}{K} \left((K-1) \left(\frac{10 \text{Old avg}}{20} \right) + 10 \text{New data} \right) \right)$$

Equation assumes all values are in the decibel scale.

Key Path	Meas setup, Average Type
Example	AVER:TYPE SCAL
Notes	See “Average Type” on page 1098
Couplings	See “Auto” on page 1099
Readback	Pwr (RMS)
Initial S/W Revision	Prior to A.02.00

N dB Points

Turns N dB points on and off and allows you to set the N dB value. N dB uses the selected marker. If the selected marker is not on when N dB is turned on, the selected marker turns on, as a Normal marker, at center screen, and is used by N dB.

See [“N dB Points Results Query” on page 1102](#).

See [“More Information” on page 1102](#).

Key Path	Meas Setup
----------	-------------------

Meas Setup

Remote Command	:CALCulate:BWIDth BANDwidth:NDB <rel_ampl> :CALCulate:BWIDth BANDwidth:NDB? :CALCulate:BWIDth BANDwidth[:STATE] OFF ON 0 1 :CALCulate:BWIDth BANDwidth[:STATE]?
Notes	If the selected marker is turned Off it turns off N dB Points. N DB Points is unaffected by Auto Couple
Preset	Off, 3.01 dB OFF
Preset	Off, 3.01 dB OFF
State Saved	The on/off status and the offset value are both saved in instrument state.
Min	-140 dB
Max	-0.01 dB
Initial S/W Revision	Prior to A.02.00

N dB Points Results Query

Remote Command	:CALCulate:BWIDth BANDwidth:RESult?
Example	:CALC:MARK:AOFF set selected marker to 1 :CALC:MARK:MAX put marker 1 on peak :CALC:BWID ON turn on N dB for the selected marker (1) :CALC:BWID:NDB-3.01 set the offset to -3.01 dB :CALC:BWID:RES? Query the result
Notes	-100 returned if invalid reading
Initial S/W Revision	Prior to A.02.00

More Information

A marker should be placed on the peak of interest before turning on N dB points. The N dB points function looks for the two points on the marker's trace closest to the marker's X Axis value that are N dB below the marker's amplitude, one above and the other below the marker's X Axis value. (That is, one point is to the right and one is to the left of the selected marker.) The selected N dB value is called the offset. The function reports the frequency difference (for frequency domain traces) or time difference (for time domain traces) between those two points.

Each point is identified by a horizontal arrow pointing towards the marker, next to the trace. The arrows used by the N dB Points function will be as shown in the figure below (where each square represents one pixel). They point in, horizontally, at the trace below a peak, on either side of its skirts. There is one pixel between the arrow and the trace

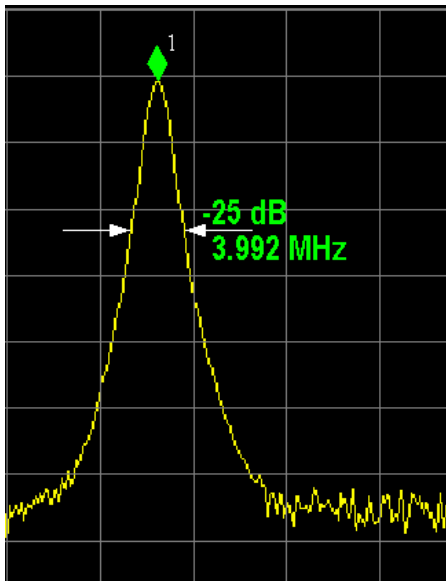

N dB Points can be used to measure the bandwidth of a signal; it is commonly used in conjunction with a tracking generator to measure filter bandwidths.

In one of the common use cases, the marker is placed on a peak, and the arrows are displayed N dB down the skirt from the marker on either side of the peak. The N dB value and the frequency difference between the two arrows is displayed around the arrow as shown in the figure above. Normally this displays on the right hand arrow, but if this would place any part of the text offscreen to the right then it displays on the left arrow.

If the analyzer is unable to find data that is N dB below the marker on either side of the marker, the arrows are displayed at the indicator point of the marker, no value (---) will be displayed as the result and -100 Hz returned remotely (see figure below):



Some sample N dB scenarios are shown below, to illustrate how the function works in various cases. In each case, the two-headed blue arrow represents N dB of amplitude.

Meas Setup

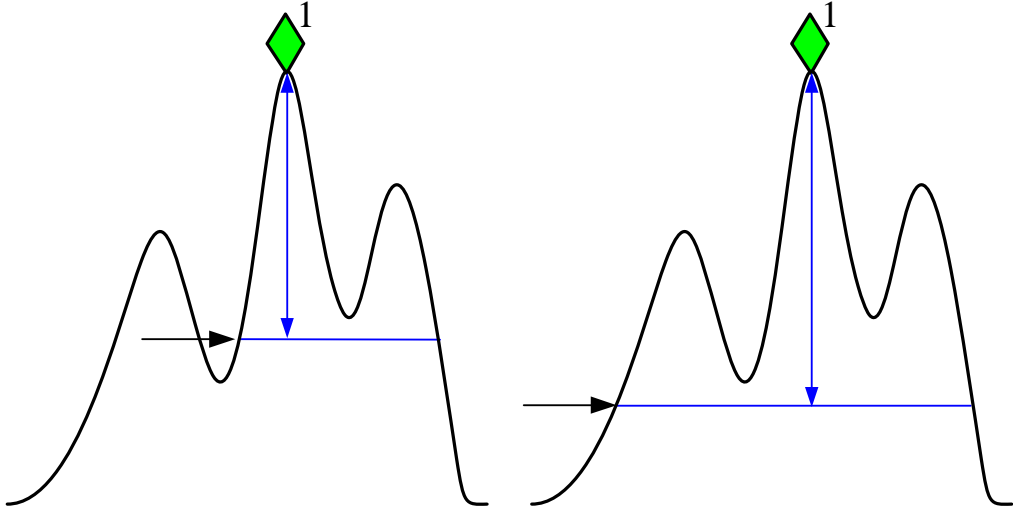
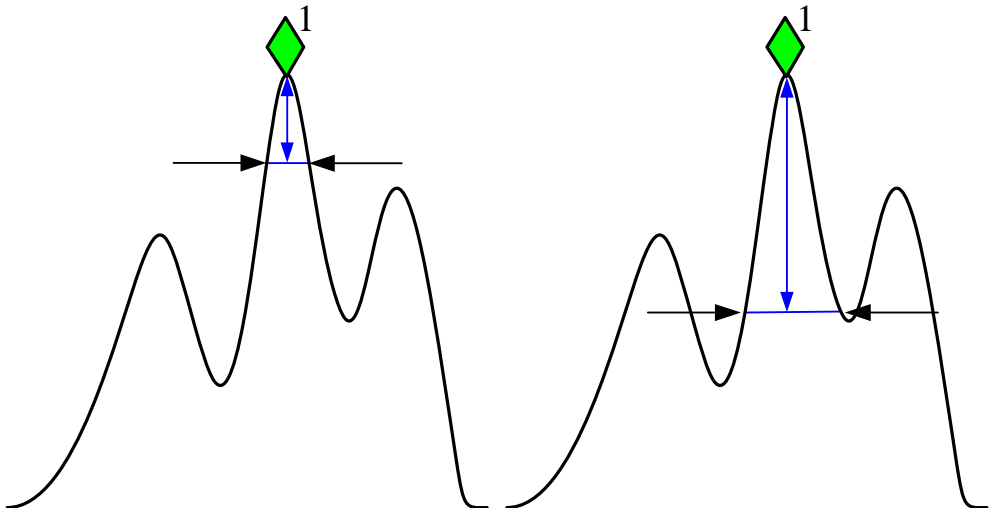

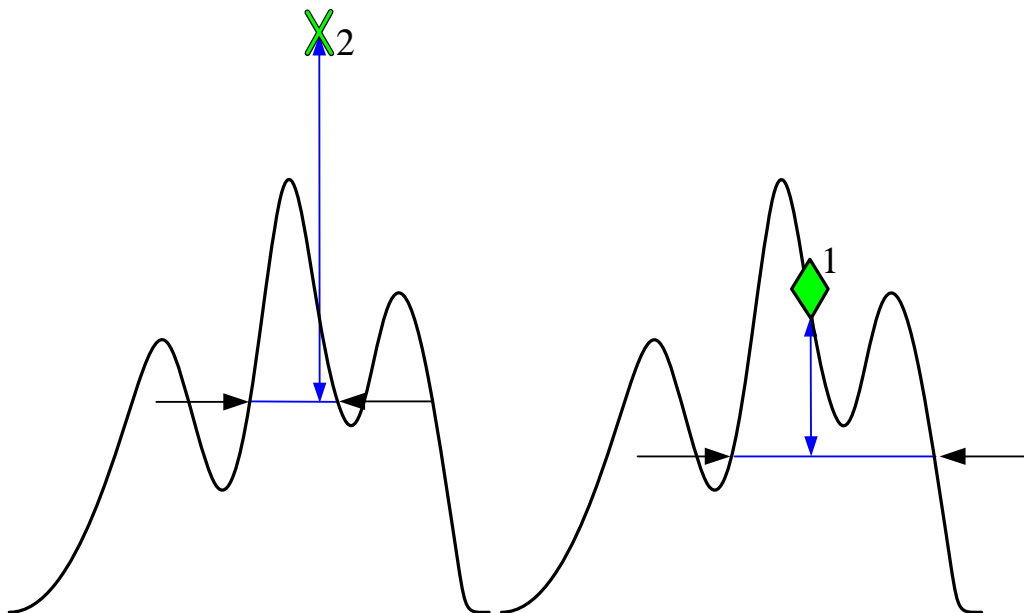

PhNoise Opt

Selects the LO (local oscillator) phase noise behavior for various desired operating conditions.

Remote Command	[:SENSE] :FREQUENCY:SYNTHESIS [:STATE] 1 2 3 [:SENSE] :FREQUENCY:SYNTHESIS [:STATE] ?
Example	FREQ:SYNT 2 selects optimization for best wide offset phase noise
Notes	Parameter: <ol style="list-style-type: none"> 1. optimizes phase noise for small frequency offsets from the carrier. 2. optimizes phase noise for wide frequency offsets from the carrier. 3. optimizes LO for tuning speed (In PXA, the local oscillator hardware provides for extra-low phase noise at the expense of some speed. In these models, the “fast tuning” option lets you go faster at the expense of some noise. In all other models, the fastest possible tuning is the same as the close-in phase noise setting; in those models, the settings for option 1 are used if option 3 is selected.)
Dependencies	Does not appear in all models. The key is blank in those models, but the SCPI command is accepted for compatibility (although no action is taken).
Preset	Because this function is in Auto after preset, and because Span after preset > 314.16 kHz (see Auto rules, next section) the state of this function after Preset will be 2
Initial S/W Revision	Prior to A.02.00
Modified at S/W Revision	A.02.00

Meas Setup

Auto

Selects the LO (local oscillator) phase noise behavior to optimize dynamic range and speed for various instrument operating conditions.

The X-Series has two grades of LO; a high performance LO that gives the best phase noise performance; and a medium-performance LO that gives excellent performance.

In models with the high performance LO, Auto will choose:

Fast Tuning whenever Span > 44.44 MHz or RBW > 1.9 MHz or if Source Mode is set to “Tracking”

otherwise, if center frequency is < 195 kHz OR ALL of the following are true:

CF >= 1 MHz AND Span <= 1.3 MHz AND RBW <= 75 kHz

then Best Close in Phase Noise;

otherwise, Best Wide-offset Phase Noise

In models with the medium-performance LO, Auto will choose:

Fast Tuning whenever Span > 12.34 MHz or RBW > 250 kHz or if Source Mode is set to “Tracking”

otherwise, if center frequency is < 25 kHz OR ALL of the following are true:

CF >= 1 MHz AND Span <= 141.4 kHz AND RBW <= 5 kHz

then **Best Close in Phase Noise**;

otherwise, **Best Wide-offset Phase Noise**

In units whose hardware does not provide for an extra-fast tuning option, the settings for Fast Tuning are the same as Best Close-in, so in those models you will see no difference between these settings.

These rules apply whether in swept spans, zero span, or FFT spans.

Key Path	Meas Setup, PhNoise Opt
Remote Command	[:SENSe] :FREQuency:SYNTHeSis:AUTO [:STATe] OFF ON 0 1 [:SENSe] :FREQuency:SYNTHeSis:AUTO [:STATe] ?
Example	FREQ:SYNT:AUTO ON
Preset	ON
State Saved	Saved in instrument state.
Initial S/W Revision	Prior to A.02.00

Best Close-in P Noise

The LO phase noise is optimized for smaller offsets from the carrier, at the expense of phase noise farther out.

Key Path	Meas Setup, PhNoise Opt
Example	FREQ:SYNT 1

Couplings	The frequency below which the phase noise is optimized is model dependent: CXA: n/a EXA: [offset <20 kHz] MXA: [offset <20 kHz] PXA: [offset <140 kHz]
Readback	Close-in. If manually selected the “Man” will be underlined. The actual frequency offset within which noise is optimized is shown with in square brackets, as this can vary depending on the hardware set in use. For example, in some analyzers this annotation appears as [offset <20 kHz]
Initial S/W Revision	Prior to A.02.00

Best Wide-offset P Noise

The LO phase noise is optimized for wider offsets from the carrier. Optimization is especially improved for offsets from 70 kHz to 300 kHz. Closer offsets are compromised and the throughput of measurements (especially remote measurements where the center frequency is changing rapidly), is reduced.

Key Path	Meas Setup, PhNoise Opt
Example	FREQ:SYNT 2
Couplings	The frequency below which the phase noise is optimized is model dependent: CXA: n/a EXA: [offset >30 kHz] MXA: [offset >30 kHz] PXA: [offset >160 kHz]
Readback	Wide-offset. If manually selected the “Man” will be underlined. The actual frequency offset beyond which noise is optimized is shown with in square brackets, as this can vary depending on the hardware set in use. For example, in some analyzers this annotation appears as [offset >30 kHz]
Initial S/W Revision	Prior to A.02.00

Fast Tuning

In this mode, the LO behavior compromises phase noise at many offsets from the carrier in order to allow rapid measurement throughput when changing the center frequency or span. The term “fast tuning” refers to the time it takes to move the local oscillator to the start frequency and begin a sweep; this setting does not impact the actual sweep time in any way.

In this mode in PXA, the LO behavior compromises phase noise at offsets below 4 MHz in order to improve measurement throughput. The throughput is especially affected when moving the LO more than 2.5 MHz and up to 10 MHz from the stop frequency to the next start frequency.

Meas Setup

(In models whose hardware does not provide for a fast tuning option, the settings for Best Close-in P Noise are used if Fast Tuning is selected. This gives the fastest possible tuning for that hardware set.)

Key Path	Meas Setup, PhNoise Opt
Example	FREQ:SYNT 3
State Saved	Saved in instrument state.
Readback	Fast Tuning. Also, the “Man” must be underlined.
Initial S/W Revision	Prior to A.02.00

ADC Dither

Accesses the menu to control the ADC Dither function. The dither function enhances linearity for low level signals at the expense of reduced clipping-to-noise ratio. The reduced clipping-to-noise ratio results in higher noise, because we work to ensure that the clipping level of the ADC relative to the front terminals remains unchanged with the introduction of dither, and this results in reduced ADC dynamic range. So making measurements with ADC dither gives you better amplitude linearity, but turning ADC dither off gives you a lower noise floor (better sensitivity).

With dither on, the third-order distortions are usually invisible for mixer levels below –35 dBm. With dither off, these distortions can be visible, with typical power levels of –110 dBm referred to the mixer. Detection nonlinearity can reach 1 dB for dither off at mixer levels around –70 dBm and lower, while the specified nonlinearity is many times smaller with dither on.

When ADC Dither is on, the linearity of low-level signals is improved. The enhanced linearity is mostly improved scale fidelity. The linearity improvements of dither are most significant for RBWs of 3.9 kHz and less in swept mode, and FFT widths of 4 kHz and less in FFT mode.

The increased noise due to turning dither on is most significant in low band (0 to 3.6 GHz) with IF Gain set to Low, where it can be about 0.2 dB.

Key Path	Meas Setup
Remote Command	[:SENSe] :ADC:DITHer [:STATe] OFF ON HIGH [:SENSe] :ADC:DITHer [:STATe] ?
Example	ADC:DITH:HIGH Sets the ADC dither setting to High ADC:DITH ON Sets the ADC dither setting to Medium In older instruments the “Medium” key was labeled “On” and the SCPI for this setting is NOT changing.
Dependencies	In some models, the “High” parameter is not available. In some instruments, the HIGH parameter is honored and the HIGH state set, and returned to a query, but the Medium dither level is actually used.
Preset	AUTO

Backwards Compatibility SCPI	The old command [:SENSe]:ADC:DITHer AUTO is aliased to [:SENSe]:ADC:DITHer:AUTO[:STATe] ON; because of this, the [:SENSe]:ADC:DITHer function cannot be a true Boolean, so the query, [:SENSe]:ADC:DITHer? returns OFF or ON (not 1 or 0 like a true Boolean)
Initial S/W Revision	Prior to A.02.00
Modified at S/W Revision	A.02.00

Auto

Sets the ADC dither to automatic. The analyzer then chooses the dither level according to which is most likely to be the best selection, based on other settings within the digital IF.

When in Auto, the analyzer sets the dither to Medium whenever the effective IF Gain is Low by this definition of IF Gain = Low:

- When Sweep Type = Swept, IF Gain = Low whenever Swept IF Gain is set to Low Gain, whether by autocoupling or manual selection.
- When Sweep Type = FFT, IF Gain = Low whenever FFT IF Gain is set to "Low Gain," which cannot happen by autocoupling.

Whenever the IF Gain is not low by this definition, Auto sets the dither to Off.

Key Path	Meas Setup, ADC Dither
Remote Command	[:SENSe] :ADC:DITHer:AUTO[:STATe] OFF ON 0 1 [:SENSe] :ADC:DITHer:AUTO[:STATe] ?
Example	ADC:DITH:AUTO ON
Preset	ON
State Saved	Saved in instrument state
Readback	The "Auto" is underlined, and the readback value is whatever setting is auto-selected
Initial S/W Revision	Prior to A.02.00

High (Best Log Accy)

When ADC dither is set to High, the scale fidelity is especially good, most notably the relative scale fidelity. The tradeoff is that there is a modest loss of noise floor performance, up to about a decibel.

Key Path	Meas setup, ADC Dither
Example	ADC:DITH:HIGH
Readback	If manually selected, the readback is High, with the "Man" underlined
Initial S/W Revision	A.02.00

Meas Setup

Medium (Log Accy)

The Medium setting of ADC Dither (known as “On” in earlier versions of the instrument software) improves the linearity of low-level signals at the expense of some noise degradation.

Key Path	Meas setup, ADC Dither
Example	ADC:DITH:ON
Readback	If manually selected, the readback is Medium, with the “Man” underlined
Initial S/W Revision	Prior to A.02.00
Modified at S/W Revision	A.02.00

Off (Best Noise)

When ADC Dither is Off, the instrument noise floor is improved, because without the need to make room for the dither, you get a lower noise floor and better sensitivity.

Key Path	Meas setup, ADC Dither
Example	ADC:DITH:OFF
Readback	If manually selected, the readback is Off, with the “Man” underlined.
Initial S/W Revision	Prior to A.02.00

Swept IF Gain

To take full advantage of the RF dynamic range of the analyzer, there is an added switched IF amplifier with approximately 10 dB of gain. When you can turn it on without overloading the analyzer, the dynamic range is always better with it on than off. The **Swept IF Gain** key can be used to set the IF Gain function to Auto, or to High Gain (the extra 10 dB), or to Low Gain. These settings affect sensitivity and IF overloads.

This function is only active when in Swept sweeps. In FFT sweeps, the FFT IF Gain function is used instead.

Key Path	Meas Setup
Remote Command	[:SENSe] : IF : GAIN : SWEPT [:STATe] OFF ON 0 1 [:SENSe] : IF : GAIN : SWEPT [:STATe] ?
Example	IF:GAIN:SWEP ON
Notes	where ON = high gain OFF = low gain

Couplings	<p>The ‘auto’ rules for Swept IF Gain depend on attenuation, preamp state, start and stop frequency and the setting of FFT IF Gain. Set the Swept IF Gain to High (On) when the total input attenuation is 0 dB, the preamp is off, the start frequency is 10 MHz or more, and the FFT IF Gain is autocoupled, or manually set to Autorange, or manually set to High. Also set the Swept IF Gain to High (On) when the total input attenuation is 2 dB or less, the preamp is on, the start frequency is 10 MHz or more, and the stop frequency is 3.6 GHz or less and the FFT IF Gain is autocoupled, or manually set to Autorange, or manually set to High. Under all other circumstances, set the Swept IF Gain to Low (Off).</p> <p>If the sweep type is Swept, the start frequency of the instrument is less than 10 MHz, and you put Swept IF Gain in Manual On, a warning condition is generated and remains in effect as long as this condition exists. The warning message is about a possible IF overload.</p> <p>As with most parameters with an AUTO state, AUTO COUPLE sets it to Auto, and setting any specific value (for example on or off) will set the AUTO state to false.</p>
Preset	<p>Auto after a Preset which yields Off unless the Preamp is on.</p> <p>Auto and Off after Meas Preset.</p>
State Saved	Saved in instrument state.
Readback Line	High Gain or Low Gain
Initial S/W Revision	Prior to A.02.00

Auto

Activates the auto rules for Swept IF Gain

Key Path	Meas setup
Remote Command	<pre>[:SENSE] :IF:GAIN:SWEPT:AUTO[:STATe] OFF ON 0 1 [:SENSE] :IF:GAIN:SWEPT:AUTO[:STATe] ?</pre>
Example	IF:GAIN:SWEP:AUTO ON
Preset	ON
Initial S/W Revision	Prior to A.02.00

Low Gain (Best for Large Signals)

Forces Swept IF Gain to be off.

Key Path	Meas setup, ADC Ranging
Example	IF:GAIN:SWEP OFF
State Saved	Saved in instrument state.
Readback	Low Gain

Meas Setup

Initial S/W Revision	Prior to A.02.00
----------------------	------------------

High Gain (Best Noise Level)

Forces Swept IF Gain to be on.

Key Path	Meas setup, ADC Ranging
Example	IF:GAIN:SWEP ON
Dependencies	The High setting for Swept IF Gain is grayed out when FFT IF Gain is manually set to Low (not when Low is chosen by the auto-rules).
State Saved	Saved in instrument state.
Readback	High Gain
Initial S/W Revision	Prior to A.02.00

FFT IF Gain

Accesses the keys to set the ranging in the digital IF when doing FFT sweeps. When in Autorange mode, the IF checks its range once for every FFT chunk, to provide the best signal to noise ratio. You can specify the range for the best FFT speed, and optimize for noise or for large signals.

When the sweep type is FFT and this function is in Autorange, the IF Gain is set ON initially for each chunk of data. The data is then acquired. If the IF overloads, then the IF Gain is set OFF and the data is re-acquired. Because of this operation, the Auto setting uses more measurement time as the instrument checks/resets its range. You can get faster measurement speed by forcing the range to either the high or low gain setting. But you must know that your measurement conditions will not overload the IF (in the high gain range) and that your signals are well above the noise floor (for the low gain range), and that the signals are not changing.

Key Path	Meas Setup
Remote Command	[:SENSe] : IF : GAIN : FFT [: STATe] AUTOrange LOW HIGH [:SENSe] : IF : GAIN : FFT [: STATe] ?
Couplings	As with most parameters with an AUTO state, AUTO COUPLE sets it to Auto, which then picks AUTOrange, and setting any specific value (AUTOrange, LOW or HIGH) will set the AUTO state to false.
Preset	AUTOrange
State Saved	Saved in instrument state.
Readback Line	Autorange, High Gain or Low Gain
Initial S/W Revision	Prior to A.02.00

Auto

Allows the instrument to pick the FFT IF Gain method as appropriate. This “Auto” state is set by the

Auto Couple key, and it puts it in Autorange.

Key Path	Meas setup
Remote Command	[:SENSE] : IF:GAIN:FFT:AUTO [:STATe] OFF ON 0 1 [:SENSe] : IF:GAIN:FFT:AUTO [:STATe] ?
Example	IF:GAIN:FFT:AUTO ON
Preset	ON
State Saved	Saved in instrument state.
Backwards Compatibility SCPI	DISPlay:WINDow[1]:TRACe:Y[:SCALe]:LOG:RANGe:AUTO
Initial S/W Revision	Prior to A.02.00

Autorange (Slower – Follows Signals)

Turns the ADC ranging to automatic which provides the best signal to noise ratio. Autorange is usually preferred over the manual range choices.

Key Path	Meas setup, FFT IF Gain
Example	IF:GAIN:FFT AUORange
State Saved	Saved in instrument state.
Readback	Autorange
Initial S/W Revision	Prior to A.02.00

Low Gain (Best for Large Signals)

Forces FFT IF Gain to be off.

Key Path	Meas setup, FFT IF Gain
Example	IF:GAIN:FFT LOW
State Saved	Saved in instrument state.
Readback	Low Gain
Initial S/W Revision	Prior to A.02.00

High Gain (Best Noise Level)

Forces FFT IF Gain to be on.

Key Path	Meas setup, FFT IF Gain
Example	IF:GAIN:FFT HIGH
Dependencies	The High setting for FFT IF Gain is grayed out when Swept IF Gain is manually set to Low (not when Low is chosen by the auto-rules).

Meas Setup

State Saved	Saved in instrument state.
Readback	High Gain
Initial S/W Revision	Prior to A.02.00

Analog Demod Tune & Listen

The Analog Demod Tune & Listen key opens the Analog Demod menu which contains keys to turn the demod function on and off and select modulation type. This key only appears if the N9063A Analog Demod personality is installed and licensed, or if Option EMC is installed and licensed.

When the function is on (set to AM, FM, or PM), the demodulated signal is fed to the analyzer's speaker. Muting and volume control functions are done through the standard Windows speaker volume control interface.

Key Path	Meas Setup
Remote Command	[:SENSE] :DEMod AM FM PM OFF [:SENSE] :DEMod?
Example	DEM AM turns amplitude demodulation function ON
Dependencies	When Tune & Listen is turned on, all active traces are forced to use the same detector. CISPR detectors (QPD, EMI Avg, RMS Avg) and Tune & Listen are mutually exclusive. No sound output will be heard if one of these detectors is selected.
Preset	OFF
State Saved	Saved in instrument state.
Initial S/W Revision	Prior to A.02.00
Modified at S/W Revision	A.02.00

AM

Pressing this key, when it is not selected, selects and activates the AM demodulation function. Pressing it a second time branches to the AM Demod menu where AM demodulation settings can be adjusted.

Key Path	Meas Setup, Analog Demod Tune&Listen
State Saved	Saved in instrument state.
Initial S/W Revision	Prior to A.02.00

Channel BW (AM Demod)

Sets the RBW setting used by the hardware during the demodulation period in nonzero spans. Note that this is a separate parameter only for the demodulation function and does not affect the RBW setting in the BW menu which is used during the normal sweep. The flat top filter type must be used during the demodulation period. A 5 kHz Video Bandwidth filter is used.

In Zero Span, the instrument's RBW & VBW filters are used for the demodulation; thus, the Channel BW (and RBW filter type) will match those of the instrument. This allows gap-free listening. The Channel BW key is grayed out and the value displayed on the key matches the current RBW of the instrument. Upon leaving zero span, the non-zero-span setting of Channel BW is restored as well as the flattop filter type.

Key Path	Meas Setup, Analog Demod Tune&Listen, AM
Remote Command	[:SENSe] :DEMod:AM:BANDwidth:CHANnel <freq> [:SENSe] :DEMod:AM:BANDwidth:CHANnel?
Example	DEM:AM:BAND:CHAN 200 kHz
Notes	This key/command is grayed out in zero span.
Dependencies	Unavailable in zero span.
Couplings	In zero span only, the value is set equal to the instrument's current RBW value and it displays that value on the softkey, but the softkey is grayed out.
Preset	30 kHz
State Saved	Saved in instrument state.
Min	390 Hz
Max	8 MHz
Initial S/W Revision	Prior to A.02.00
Default Unit	Hz

FM

Pressing this key, when it is not selected, selects and activates the FM demodulation function. Pressing it a second time branches to the FM Demod menu where FM demodulation settings can be adjusted.

Key Path	Meas Setup, Analog Demod Tune&Listen
Example	DEM FM turns frequency demodulation function ON
State Saved	Saved in instrument state.
Initial S/W Revision	Prior to A.02.00

Channel BW (FM Demod)

Sets the RBW setting used by the hardware during the demodulation period in nonzero spans. Note that this is a separate parameter only for the demodulation function and does not affect the RBW setting in the BW menu which is used during the normal sweep. The flat top filter type must be used during the demodulation period. A 5 kHz Video Bandwidth filter is used.

In Zero Span, the instrument's RBW & VBW filters are used for the demodulation; thus, the Channel BW (and RBW filter type) will match those of the instrument. This allows gap-free listening. The Channel BW key is grayed out and the value displayed on the key matches the current RBW of the instrument. Upon leaving zero span, the previous setting of Channel BW and the flattop filter type are

Meas Setup

restored.

Key Path	Meas Setup, Analog Demod Tune&Listen, FM
Remote Command	[:SENSe] :DEMod:FM:BANDwidth:CHANnel <freq> [:SENSe] :DEMod:FM:BANDwidth:CHANnel?
Example	DEM:FM:BAND:CHAN 200 MHz
Notes	This key / command is grayed out in zero span
Dependencies	Unavailable in zero span.
Couplings	In zero span only, the value is set equal to the instrument's current RBW value and it displays that value on the softkey, but the softkey is grayed out.
Preset	150 kHz
State Saved	Saved in instrument state.
Min	390 Hz
Max	8 MHz
Initial S/W Revision	Prior to A.02.00
Default Unit	Hz

De-emphasis (FM Demod only)

The De-emphasis setting controls a single-pole filter (6 dB/octave roll off), usually to counter intentional pre-emphasis in the transmitter. When De-emphasis state is OFF the hardware digital filter is bypassed, otherwise the setting is applied

The De-emphasis softkey is only available when FM is the demod selected. It is grayed out for AM and PM.

Key Path	Meas Setup, Analog Demod Tune & Listen, FM
Remote Command	[:SENSe] :DEMod:FM:DEEMphasis OFF US25 US50 US75 US750 [:SENSe] :DEMod:FM:DEEMphasis?
Example	DEM:FM:DEEM US75 DEM:FM:DEEM?
Dependencies	Only available in FM. Grayed out for AM and PM.
Preset	US75 (recommended for US commercial FM 75 μ s pre-emphasis)
State Saved	Saved in instrument state.
Readback line	1-of-N selection
Initial S/W Revision	Prior to A.02.00

Off

This setting bypasses the De-emphasis filter.

Key Path	Meas Setup, Analog Demod Tune&Listen, FM, De-emphasis
Example	DEM:FM:DEEM OFF
Readback	Off
Initial S/W Revision	Prior to A.02.00

25 μ s

Sets the De-emphasis time constant to 25 μ s.

Key Path	Meas Setup, Analog Demod Tune&Listen, FM, De-emphasis
Example	DEM:FM:DEEM US25
Readback	25 μ s
Initial S/W Revision	Prior to A.02.00

50 μ s

Sets the De-emphasis time constant to 50 μ s.

Key Path	Meas Setup, Analog Demod Tune&Listen, FM, De-emphasis
Example	DEM:FM:DEEM US50
Readback	50 μ s
Initial S/W Revision	Prior to A.02.00

75 μ s

Sets the De-emphasis time constant to 75 μ s.

Key Path	Meas Setup, Analog Demod Tune&Listen, FM, De-emphasis
Example	DEM:FM:DEEM US75
Readback	75 μ s
Initial S/W Revision	Prior to A.02.00

750 μ s

Sets the De-emphasis time constant to 750 μ sec.

Key Path	Meas Setup, Analog Demod Tune&Listen, FM, De-emphasis
Example	DEM:FM:DEEM US750

Meas Setup

Readback	750 μ s
Initial S/W Revision	Prior to A.02.00

PM

Pressing this key, when it is not selected, selects and activates the PM demodulation function. Pressing it a second time branches to the PM Demod menu where PM demodulation settings can be adjusted.

Key Path	Meas Setup, Analog Demod Tune&Listen
Example	DEM PM turns Phase demodulation function ON
State Saved	Saved in instrument state.
Initial S/W Revision	Prior to A.02.00

Channel BW (PM Demod)

Sets the RBW setting used by the hardware during the demodulation period in nonzero spans. Note that this is a separate parameter only for the demodulation function and does not affect the RBW setting in the BW menu which is used during the normal sweep. The flat top filter type must be used during the demodulation period. A 5 kHz Video Bandwidth filter is used.

In Zero Span, the instrument's RBW & VBW filters are used for the demodulation; thus, the Channel BW (and RBW filter type) will match those of the instrument. This allows gap-free listening. The Channel BW key is grayed out and the value displayed on the key matches the current RBW of the instrument. Upon leaving zero span, the previous setting of Channel BW and the flattop filter type are restored.

Key Path	Meas Setup, Analog Demod Tune&Listen, M
Remote Command	[:SENSE] :DEMod:PM:BANDwidth:CHANnel <freq> [:SENSE] :DEMod:PM:BANDwidth:CHANnel?
Example	DEM:PM:BAND:CHAN 200 MHz
Notes	This key / command is grayed out in zero span
Dependencies	Unavailable in zero span.
Couplings	In zero span only, the value is set equal to the instrument's current RBW value and it displays that value on the softkey, but the softkey is grayed out.
Preset	100 kHz
State Saved	Saved in instrument state.
Min	390 Hz
Max	8 MHz
Initial S/W Revision	Prior to A.02.00
Default Unit	Hz

Off

Pressing this key, turns the demodulation function off.

Key Path	Meas Setup, Analog Demod Tune&Listen
Example	DEM OFF turns the demodulation function OFF
State Saved	Saved in instrument state.
Initial S/W Revision	Prior to A.02.00

Demod Time

Sets the amount of time the instrument demodulates the signal after each sweep. The demodulated signal can be heard through the speaker during demodulation. In zero span, demodulation can be performed continuously, making this parameter not applicable, hence it is grayed out in zero span.

Key Path	Meas Setup, Analog Demod Tune&Listen
Remote Command	[:SENSe] :DEMod:TIME <time> [:SENSe] :DEMod:TIME?
Example	DEM:TIME 500 ms DEM:TIME?
Notes	This key / command is grayed out in zero span
Dependencies	Unavailable in zero span.
Preset	500 ms
State Saved	Saved in instrument state.
Min	2 ms
Max	100 s
Initial S/W Revision	Prior to A.02.00

Demod State (Remote Command Only)

Sets or queries the state of the Analog Demod Tune and Listen function. Setting the state to ON with this command will select AM demodulation by default and activate it (turn it on).

The response to the query is determined by the current setting of [:SENSe] :DEMod AM|FM|PM|OFF. The response will be 1 if AM, FM, PM are selected, or 0 if OFF is selected..

Remote Command	[:SENSe] :DEMod:STATe OFF ON 0 1 [:SENSe] :DEMod:STATe?
Preset	OFF
Initial S/W Revision	Prior to A.02.00

Meas Setup

Noise Source

This menu allows you to turn the noise source power on or off when making manual noise figure measurements. It is included in the Spectrum Analyzer Mode as an adjunct to the full controls that are available in the Noise Figure Mode. It is only available in the Swept SA measurement of the Spectrum Analyzer Mode.

See “[More Information](#)” on page 1120.

Key Path	Meas Setup
Remote Command	:SOURce:NOISe:TYPE NORMal SNS :SOURce:NOISe:TYPE?
Example	SOUR:NOIS:TYPE NORM
Couplings	If no SNS is connected, this parameter will be set to “Normal” When Type is set to “SNS” and the SNS is disconnected, this parameter gets bumped to “Normal” When an SNS is not connected, the SNS type will be grayed (disabled).
Preset	Normal
State Saved	Saved in instrument state.
Range	Normal SNS
Remote Compatibility Info	In previous Noise Figure analysis applications, this command could optionally be preceded with the :SENSe keyword. The optional :SENSe keyword is no longer supported.
Initial S/W Revision	Prior to A.02.00

More Information

There are 2 types of noise sources: a Smart Noise Source (SNS), and a "Normal" noise source - e.g. 346 series. This menu allows the user to control both. The SNS has its own connector on the rear of the analyzer and when it is connected the user can then select it from the “Type” 1 of N, allowing the State parameter to then control the SNS. The "Normal" source is controlled by a BNC connector that supplies 28V. If SNS is NOT connected then the “state” parameter controls the "Normal" noise source 28V BNC port. If both are connected the “Type” parameter will determine which source the “State” parameter will control. Two sources can never be controlled together. The “SNS attached” SCPI query detailed below can be used remotely to determine if an SNS is connected. SNS functionality is limited to turning on and off only. The SNS ENR data and temperature cannot be queried, unless the Noise Figure application is installed. The SNS ENR data is issued in printed form when an SNS is purchased or can be read from the analyzer’s Noise Figure application if installed, or other Agilent noise figure instruments that support the SNS (NFA and ESA with option 219).

When first entering the Swept SA measurement the “State” will be set to OFF and the 28v BNC drive and SNS turned off to ensure the two are in sync. When the Swept SA measurement is exited, the “State” parameter will be set to OFF and the 28v BNC and SNS drive turned off.

For making manual noise figure measurements the following setup is recommended:

- Set the SPAN to Zero
- Set attenuation to 0 dB
- Set the PRE-AMP ON
- Set the RBW to 4MHz
- Set the Detector to AVERAGE
- Set the sweep time to 16ms - sets the variance correctly for good results.
- Set a Band/Interval Power Marker function and set the interval over the full width of trace i.e. Left to 0s and Right to 16ms

State

This key turns the Noise Source on and off.

Key Path	Meas Setup
Remote Command	:SOURce:NOISe[:STATe] ON OFF 1 0 :SOURce:NOISe[:STATe] ?
Example	SOUR:NOIS OFF
Couplings	<ol style="list-style-type: none"> 1. If an SNS is connected, and the Type is set to SNS, this parameter turns the SNS on and off. 2. When an SNS is not connected this parameter turns the BNC 28V output on and off. 3. When the SA mode is first entered this parameter is set to OFF and the 28v drive turned OFF. 4. When the SA mode is exited this parameter is set to OFF and the 28v drive turned OFF.
Preset	OFF
State Saved	Saved in instrument state.
Remote Compatibility Info	In previous Noise Figure analysis applications, this command could optionally be preceded with the :SENSe keyword. The optional :SENSe keyword is no longer supported.
Initial S/W Revision	Prior to A.02.00

SNS Attached (Remote Command Only)

If an Smart Noise Source (SNS) is present this command will return 1 otherwise it will return 0.

Remote Command	:SOURce:NOISe:SNS:ATTached?
Example	SOUR:NOIS:SNS:ATT?
Preset	OFF

Meas Setup

State Saved	No
Remote Compatibility Info	In previous Noise Figure analysis applications, this command could optionally be preceded with the :SENSe keyword. The optional :SENSe keyword is no longer supported.
Initial S/W Revision	Prior to A.02.00

Meas Preset

This key returns the Meas Local variables in the Swept SA measurement to their preset values. This is the same as sending the SCPI command CONF:SAN.

The only exception is Limits On/Off, which is a persistent Meas Local variable. It will be set to Off by a Mode Preset but not by Meas Preset.

Key Path	Meas Setup
Initial S/W Revision	Prior to A.02.00

Mode

The Mode key allows you to select the available measurement applications or “Modes”. Modes are a collection of measurement capabilities packaged together to provide an instrument personality that is specific to your measurement needs. Each application software product is ordered separately by Model Number and must be licensed to be available. Once an instrument mode is selected, only the commands that are valid for that mode can be executed.

NOTE Key operation can be different between modes. The information displayed in Help is about the current mode.

To access Help for a different Mode you must first exit Help (by pressing the Cancel (Esc) key). Then select the desired mode and re-access Help.

For more information on Modes, preloading Modes, and memory requirements for Modes, see “[More Information](#)” on page 1124

Key Path	Front-panel key
Remote Command	:INSTrument [:SElect] SA BASIC WCDMA CDMA2K EDGE GSM PNOISE CDMA1XEV CWLAN WIMAX OFDMA CWIMAX OFDM VSA VSA89601 LTE IDEN WIMAX FIXED LTE TDD TDSCDMA NFIGURE ADEMOD DVB DTMB ISDBT CMMB RLC SCPI LC BT :INSTrument [:SElect] ?
Example	:INST SA
Notes	The available parameters are dependent upon installed and licensed applications resident in the instrument. Parameters given here are an example, specific parameters are in the individual Application. A list of the valid mode choices is returned with the INST:CAT? Query.
Preset	Not affected by Preset. Set to SA following Restore System Defaults, if SA is the default mode.
State Saved	Saved in instrument state
Initial S/W Revision	Prior to A.02.00
Help Map ID	2670

Example	:INST 'SA'
Notes	NOTE: The query is not a quoted string. It is an enumeration as indicated in the Instrument Select table above. The command must be sequential: i.e. continued parsing of commands cannot proceed until the instrument select is complete and the resultant SCPI trees are available.

Mode

Backwards Compatibility SCPI	:INSTrument[:SElect] 'SA' 'PNOISE' 'EDGE' 'GSM' 'BASIC'
Initial S/W Revision	Prior to A.02.00
Help Map ID	0

More Information

The Mode name appears on the banner after the word “Agilent” followed by the Measurement Title. For example, for the Spectrum Analyzer mode with the Swept Sa measurement running:



It is possible to specify the order in which the Modes appear in the Mode menu, using the Configure Applications utility (**System, Power On, Configure Applications**). It is also possible, using the same utility, to specify a subset of the available applications to load into memory at startup time, which can significantly decrease the startup time of the analyzer. During runtime, if an application that is not loaded into memory is selected (by either pressing that applications Mode key or sending that applications :INST:SEL command over SCPI), there will be a pause while the Application is loaded. During this pause a message box that says “Loading application, please wait...” is displayed.

Each application (Mode) that runs in the X-Series signal analyzers consumes virtual memory. The various applications consume varying amounts of virtual memory, and as more applications run, the memory consumption increases. Once an application is run, some of its memory remains allocated even when it is not running, and is not released until the analyzer program (xSA.exe) is shut down.

Agilent characterizes each Mode and assigns a memory usage quantity based on a conservative estimate. There is a limited amount of virtual memory available to applications (note that this is virtual memory and is independent of how much physical RAM is in the instrument). The instrument keeps track of how much memory is being used by all loaded applications – which includes those that preloaded at startup, and all of those that have been run since startup.

When you request a Mode that is not currently loaded, the instrument looks up the memory estimate for that Mode, and adds it to the residual total for all currently loaded Modes. If there is not enough virtual memory to load the Mode, a dialog box and menu will appear that gives you four options:

Close and restart the analyzer program without changing your configured preloads. This may free up enough memory to load the requested Mode, depending on your configured preloads

Clear out all preloads and close and restart the analyzer program with only the requested application preloaded, and with that application running. This choice is guaranteed to allow you to run the requested application; but you will lose your previously configured preloads. In addition, there may be little or no room for other applications, depending on the size of the requested application.

Bring up the Configure Applications utility in order to reconfigure the preloaded apps to make room for the applications you want to run (this will then require restarting the analyzer program with your new configuration). This is the recommended choice because it gives you full flexibility to select exactly what you want.

Exit the dialog box without doing anything, which means you will be unable to load the application you requested.

In each case except 4, this will cause the analyzer software to close, and you will lose all unsaved traces

and results.

If you attempt to load a mode via SCPI that will exceed memory capacity, the Mode does not load and an error message is returned:

```
-225, "Out of memory; Insufficient resources to load Mode (mode name) "
```

where “mode name” is the SCPI parameter for the Mode in question, for example, SA for Spectrum Analyzer Mode

Application Mode Number Selection (Remote Command Only)

Select the measurement mode by its mode number. The actual available choices depend upon which applications are installed in your instrument. The modes appear in this table by NSEL number, which is not the same as their order in the Mode menu (see [“Detailed List of Options” on page 1130](#) for the mode order).

Mode	:INSTRument:NSElect <integer>	:INSTRument[:SElect] <parameter>
Spectrum Analyzer	1	SA
I/Q Analyzer (Basic)	8	BASIC
WCDMA with HSDPA/HSUPA	9	WCDMA
cdma2000	10	CDMA2K
GSM/EDGE/EDGE Evo	13	EDGE GSM
Phase Noise	14	PNOISE
1xEV-DO	15	CDMA1XEV
Combined WLAN	19	CWLAN
802.16 OFDMA (WiMAX/WiBro)	75	WIMAXOFDMA
Combined Fixed WiMAX	81	CWIMAXOFDM
Vector Signal Analyzer (VXA)	100	VSA
89601 VSA	101	VSA89601
LTE	102	LTE
iDEN/WiDEN/MotoTalk	103	IDEN
802.16 OFDM (Fixed WiMAX)	104	WIMAXFIXED
LTE TDD	105	LTETDD
TD-SCDMA with HSPA/8PSK	211	TDSCDMA
Noise Figure	219	NFIGURE
Bluetooth	228	BT
Analog Demod	234	ADEMOM

Mode

Mode	:INSTRument:NSElect <integer>	:INSTRument[:SElect] <parameter>
DVB-T/H	235	DVB
DTMB (CTTB)	236	DTMB (CTTB)
ISDB-T	239	ISDBT
CMMB	240	CMMB
Remote Language Compatibility	266	RLC
SCPI Language Compatibility	270	SCPILC

Remote Command	:INSTRument:NSElect <integer> :INSTRument:NSElect?
Example	:INST:NSEL 1
Notes	SA mode is 1 The command must be sequential: i.e. continued parsing of commands cannot proceed until the instrument select is complete and the resultant SCPI trees are available.
Preset	Not affected by Preset. Set to default mode (1 for SA mode) following Restore System Defaults.
State Saved	Saved in instrument state
Initial S/W Revision	Prior to A.02.00
Help Map ID	0

Application Mode Catalog Query (Remote Command Only)

Returns a string containing a comma separated list of names of all the installed and licensed measurement modes (applications). These names can only be used with the :INSTRument[:SElect] command.

Remote Command	:INSTRument:CATalog?
Example	:INST:CAT?
Notes	Query returns a quoted string of the installed and licensed modes separated with a comma. Example: "SA,PNOISE,WCDMA"
Initial S/W Revision	Prior to A.02.00
Help Map ID	0

Application Identification (Remote Commands Only)

Each entry in the Mode Menu will have a Model Number and associated information: Version, and

Options.

This information is displayed in the Show System screen. The corresponding SCPI remote commands are defined here.

Current Application Model

Returns a string that is the Model Number of the currently selected application (mode).

Remote Command	:SYSTem:APPLication[:CURRent] [:NAME] ?
Example	:SYST:APPL?
Notes	Query returns a quoted string that is the Model Number of the currently selected application (Mode). Example: "N9060A" String length is 6 characters.
Preset	Not affected by Preset
State Saved	Not saved in state, the value will be the selected application when a Save is done.
Initial S/W Revision	Prior to A.02.00
Help Map ID	0

Current Application Revision

Returns a string that is the Revision of the currently selected application (mode).

Remote Command	:SYSTem:APPLication[:CURRent] :REvision?
Example	:SYST:APPL:REV?
Notes	Query returns a quoted string that is the Revision of the currently selected application (Mode). Example: "1.0.0.0" String length is a maximum of 23 characters. (each numeral can be an integer + 3 decimal points)
Preset	Not affected by a Preset
State Saved	Not saved in state, the value will be the selected application when a Save is done.
Initial S/W Revision	Prior to A.02.00
Help Map ID	0

Mode

Current Application Options

Returns a string that is the Options list of the currently selected application (Mode).

Remote Command	:SYSTem:APPLication[:CURRent]:OPTion?
Example	:SYST:APPL:OPT?
Notes	Query returns a quoted string that is the Option list of the currently selected application (Mode). The format is the name as the *OPT? or SYSTem:OPTion command: a comma separated list of option identifiers. Example: "1FP,2FP" String length is a maximum of 255 characters.
Preset	Not affected by a Preset
State Saved	Not saved in state per se, the value will be the selected application when a Save is invoked.
Initial S/W Revision	Prior to A.02.00
Help Map ID	0

Application Identification Catalog (Remote Commands Only)

A catalog of the installed and licensed applications (Modes) can be queried for their identification.

Application Catalog number of entries

Returns the number of installed and licensed applications (Modes).

Remote Command	:SYSTem:APPLication:CATalog[:NAME]:COUNT?
Example	:SYST:APPL:CAT:COUN?
Preset	Not affected by Preset
State Saved	Not saved in instrument state.
Initial S/W Revision	Prior to A.02.00
Help Map ID	0

Application Catalog Model Numbers

Returns a list of Model Numbers for the installed and licensed applications (Modes).

Remote Command	:SYSTem:APPLication:CATalog[:NAME]?
Example	:SYST:APPL:CAT?

Notes	Returned value is a quoted string of a comma separated list of Model Numbers. Example, if SAMS and Phase Noise are installed and licensed: "N9060A,N9068A" String length is COUNT * 7 - 1. (7 = Model Number length + 1 for comma. -1 = no comma for the 1st entry.)
Preset	Not affected by a Preset
State Saved	Not saved in instrument state.
Initial S/W Revision	Prior to A.02.00
Help Map ID	0

Application Catalog Revision

Returns the Revision of the provided Model Number.

Remote Command	:SYSTem:APPLication:CATalog:REVision? <model>
Example	:SYST:APPL:CAT:REV? 'N9060A'
Notes	Returned value is a quoted string of revision for the provided Model Number. The revision will be a null-string (") if the provided Model Number is not installed and licensed. Example, if SAMS is installed and licensed: "1.0.0.0"
Preset	Not affected by a Preset.
State Saved	Not saved in instrument state.
Initial S/W Revision	Prior to A.02.00
Help Map ID	0

Application Catalog Options

Returns a list of Options for the provided Model Number

Remote Command	:SYSTem:APPLication:CATalog:OPTion? <model>
Example	:SYST:APPL:CAT:OPT? 'N9060A'
Notes	Returned value is a quoted string of a comma separated list of Options, in the same format as *OPT? or :SYSTem:OPTion?. If the provided Model Number is not installed and licensed a null-string (") will be returned. Example, if SAMS is installed and licensed: "2FP" String length is a maximum of 255 characters.
Preset	Not affected by a Preset
State Saved	Not saved in instrument state.

Mode

Initial S/W Revision	Prior to A.02.00
Help Map ID	0

Detailed List of Options

This section contains a brief description of each Mode available for the X-Series. The order in which the Modes appear by default (if it is not changed by the Configure Applications utility found in the System, Power On menu) is the same as the order in which they appear in this section.

Note that although generally only licensed applications appear on the Mode menu, the 89601 will always appear, because its licensing is handled differently.

Spectrum Analyzer

Selects the Spectrum Analyzer mode for general purpose measurements. There are several measurements available in this mode. General spectrum analysis measurements, in swept and zero span, can be done using the first key in the Meas menu, labeled Swept SA. Other measurements in the Meas Menu are designed to perform specialized measurement tasks, including power and demod measurements.

If you are using the Help feature, this mode must be currently active to access its detailed information. If it is not active, exit the Help feature (Esc key), select the mode, and re-access Help.

Key Path	Mode
Example	INST:SEL SA INST:NSEL 1
Initial S/W Revision	Prior to A.02.00
Help Map ID	3525

IQ Analyzer (Basic)

The IQ Analyzer Mode makes general purpose frequency domain and time domain measurements. These measurements often use alternate hardware signal paths when compared with a similar measurement in the Signal Analysis Mode using the Swept SA measurement. These frequency domain and time domain measurements can be used to output I/Q data results when measuring complex modulated digital signals.

If you are using the Help feature, this mode must be currently active to access its detailed information. If it is not active, exit the Help feature (Esc key), select the mode, and re-access Help.

Key Path	Mode
Example	INST:SEL BASIC INST:NSEL 8
Initial S/W Revision	Prior to A.02.00
Help Map ID	3526

W-CDMA with HSDPA/HSUPA

Selects the W-CDMA with HSDPA/HSUPA mode for general purpose measurements of signals following this standard. There are several measurements available in this mode.

If you are using the Help feature, this mode must be currently active to access its detailed information. If it is not active, exit the Help feature (Esc key), select the mode, and re-access Help.

Key Path	Mode
Example	INST:SEL WCDMA INST:NSEL 9
Initial S/W Revision	Prior to A.02.00
Help Map ID	3530

GSM/EDGE/EDGE Evo

Selects the GSM with EDGE mode for general purpose measurements of signals following this standard. There are several measurements available in this mode.

If you are using the Help feature, this mode must be currently active to access its detailed information. If it is not active, exit the Help feature (Esc key), select the mode, and re-access Help.

Key Path	Mode
Example	INST:SEL EDGE GSM INST:NSEL 13
Initial S/W Revision	Prior to A.02.00
Modified at S/W Revision	A.02.00
Help Map ID	3532

802.16 OFDMA (WiMAX/WiBro)

Selects the OFDMA mode for general purpose measurements of WiMAX signals. There are several measurements available in this mode.

If you are using the Help feature, this mode must be currently active to access its detailed information. If it is not active, exit the Help feature (Esc key), select the mode, and re-access Help.

Key Path	Mode
Example	INST:SEL WIMAX OFDMA INST:NSEL 75
Initial S/W Revision	Prior to A.02.00
Help Map ID	3531

Mode

Vector Signal Analyzer (VXA)

The N9064A (formerly 89601X) VXA Vector signal and WLAN modulation analysis application provides solutions for basic vector signal analysis, analog demodulation, digital demodulation and WLAN analysis. The digital demodulation portion of N9064A allows you to perform measurements on standard-based formats such as cellular, wireless networking and digital video as well as general purpose flexible modulation analysis for wide range of digital formats, FSK to 1024QAM, with easy-to-use measurements and display tools such as constellation and eye diagram, EVM traces and up to four simultaneous displays. The WLAN portion of N9064A allows you to make RF transmitter measurements on 802.11a/b/g/p/j WLAN devices. Analog baseband analysis is available using the MXA with option BBA.

N9064A honors existing 89601X licenses with all features and functionalities found on X-Series software versions prior to A.06.00.

If you are using the Help feature, this mode must be currently active to access its detailed information. If it is not active, exit the Help feature (Esc key), select the mode, and re-access Help.

Key Path	Mode
Example	INST:SEL VSA INST:NSEL 100
Initial S/W Revision	Prior to A.02.00
Help Map ID	3535

Phase Noise

The Phase Noise mode provides pre-configured measurements for making general purpose measurements of device phase noise.

If you are using the Help feature, this mode must be currently active to access its detailed information. If it is not active, exit the Help feature (Esc key), select the mode, and re-access Help.

Key Path	Mode
Example	INST:SEL PNOISE or INST:NSEL 14
Initial S/W Revision	Prior to A.02.00
Help Map ID	3527

Noise Figure

The Noise Figure mode provides pre-configured measurements for making general purpose measurements of device noise figure.

If you are using the Help feature, this mode must be currently active to access its detailed information. If

it is not active, exit the Help feature (Esc key), select the mode, and re-access Help.

Key Path	Mode
Example	INST:SEL NFIGURE Or INST:NSEL 219
Initial S/W Revision	Prior to A.02.00
Help Map ID	3528

Analog Demod

Selects the Analog Demod mode for making measurements of AM, FM and phase modulated signals.

If you are using the Help feature, this mode must be currently active to access its detailed information. If it is not active, exit the Help feature (Esc key), select the mode, and re-access Help.

Key Path	Mode
Example	INST:SEL ADEMOM INST:NSEL 234
Initial S/W Revision	Prior to A.02.00
Help Map ID	3529

Bluetooth

Selects the Bluetooth mode for Bluetooth specific measurements. There are several measurements available in this mode.

If you are using the Help feature, this mode must be currently active to access its detailed information. If it is not active, exit the Help feature (Esc key), select the mode, and re-access Help.

Key Path	Mode
Example	INST:SEL BT INST:NSEL 228
Initial S/W Revision	A.06.01
Help Map ID	30035

TD-SCDMA with HSPA/8PSK

Selects the TD-SCDMA mode for general purpose measurements of signals following this standard. There are several measurements available in this mode.

If you are using the Help feature, this mode must be currently active to access its detailed information. If

Mode

it is not active, exit the Help feature (Esc key), select the mode, and re-access Help.

Key Path	Mode
Example	INST:SEL TDSCDMA INST:NSEL 211
Initial S/W Revision	Prior to A.02.00
Help Map ID	3534

cdma2000

Selects the cdma2000 mode for general purpose measurements of signals following this standard. There are several measurements available in this mode.

If you are using the Help feature, this mode must be currently active to access its detailed information. If it is not active, exit the Help feature (Esc key), select the mode, and re-access Help.

Key Path	Mode
Example	INST:SEL CDMA2K INST:NSEL 10
Initial S/W Revision	Prior to A.02.00
Help Map ID	3533

1xEV-DO

Selects the 1xEV-DO mode for general purpose measurements of signals following this standard. There are several measurements available in this mode.

If you are using the Help feature, this mode must be currently active to access its detailed information. If it is not active, exit the Help feature (Esc key), select the mode, and re-access Help.

Key Path	Mode
Example	INST:SEL CDMA1XEV INST:NSEL 15
Initial S/W Revision	Prior to A.02.00
Help Map ID	3566

LTE

Selects the LTE mode for general purpose measurements of signals following the LTE FDD standard. There are several measurements available in this mode.

If you are using the Help feature, this mode must be currently active to access its detailed information. If

it is not active, exit the Help feature (Esc key), select the mode, and re-access Help.

Key Path	Mode
Example	INST:SEL LTE INST:NSEL 102
Initial S/W Revision	Prior to A.02.00
Help Map ID	3586

LTE TDD

Selects the LTE TDD mode for general purpose measurements of signals following the LTE TDD standard. There are several measurements available in this mode.

If you are using the Help feature, this mode must be currently active to access its detailed information. If it is not active, exit the Help feature (Esc key), select the mode, and re-access Help.

Key Path	Mode
Example	INST:SEL LTETDD INST:NSEL 105
Initial S/W Revision	A.03.00
Help Map ID	29992

DVB-T/H

Selects the DVB-T/H mode for measurements of digital video signals using this format. There are several power and demod measurements available in this mode.

If you are using the Help feature, this mode must be currently active to access its detailed information. If it is not active, exit the Help feature (Esc key), select the mode, and re-access Help.

Key Path	Mode
Example	INST:SEL DVB INST:NSEL 235
Initial S/W Revision	A.02.00
Help Map ID	3587

DTMB (CTTB)

Selects the DTMB (CTTB) mode for measurements of digital video signals using this format. There are several power and demod measurements available in this mode.

If you are using the Help feature, this mode must be currently active to access its detailed information. If

Mode

it is not active, exit the Help feature (Esc key), select the mode, and re-access Help.

Key Path	Mode
Example	INST:SEL DTMB INST:NSEL 236
Initial S/W Revision	A.02.00
Help Map ID	3588

ISDB-T

Selects the ISDB-T mode for measurements of digital video signals using this format. There are several power and demod measurements available in this mode.

If you are using the Help feature, this mode must be currently active to access its detailed information. If it is not active, exit the Help feature (Esc key), select the mode, and re-access Help.

Key Path	Mode
Example	INST:SEL ISDBT INST:NSEL 239
Initial S/W Revision	A.03.00
Help Map ID	3589

CMMB

Selects the CMMB mode for measurements of digital video signals using this format. There are several power and demod measurements available in this mode.

If you are using the Help feature, this mode must be currently active to access its detailed information. If it is not active, exit the Help feature (Esc key), select the mode, and re-access Help.

Key Path	Mode
Example	INST:SEL CMMB INST:NSEL 240
Initial S/W Revision	A.03.00
Help Map ID	3590

Combined WLAN

Selects the CWLAN mode for general purpose measurements of signals following this standard. There are several measurements available in this mode.

If you are using the Help feature, this mode must be currently active to access its detailed information. If

it is not active, exit the Help feature (Esc key), select the mode, and re-access Help.

Key Path	Mode
Example	INST:SEL CWLAN INST:NSEL 19
Initial S/W Revision	A.02.00
Help Map ID	3591

Combined Fixed WiMAX

Selects the Combined Fixed WiMAX mode for general purpose measurements of signals following this standard. There are several measurements available in this mode.

If you are using the Help feature, this mode must be currently active to access its detailed information. If it is not active, exit the Help feature (Esc key), select the mode, and re-access Help.

Key Path	Mode
Example	INST:SEL CWIMAXOFDM INST:NSEL 81
Initial S/W Revision	A.02.00
Help Map ID	3592

802.16 OFDM (Fixed WiMAX)

Selects the 802.16 OFDM (Fixed WiMAX) mode. This mode allows modulation quality measurements of signals that comply with IEEE 802.16a–2003 and IEEE 802.16–2004 standards, with flexibility to measure nonstandard OFDM formats. Along with the typical digital demodulation measurement results, several additional 802.16 OFDM unique trace data formats and numeric error data results provide enhanced data analysis.

If you are using the Help feature, this mode must be currently active to access its detailed information. If it is not active, exit the Help feature (Esc key), select the mode, and re-access Help.

Key Path	Mode
Example	INST:SEL WIMAXFIXED INST:NSEL 104
Initial S/W Revision	A.02.00
Help Map ID	29988

iDEN/WiDEN/MOTOTalk

Selects the iDEN/WiDEN/MOTOTalk mode for general purpose measurements of iDEN and iDEN-related signals. There are several measurements available in this mode.

If you are using the Help feature, this mode must be currently active to access its detailed information. If

Mode

it is not active, exit the Help feature (Esc key), select the mode, and re-access Help.

Key Path	Mode
Example	INST:SEL IDEN INST:NSEL 103
Initial S/W Revision	A.02.00
Help Map ID	29985

Remote Language Compatibility

The Remote Language Compatibility (RLC) mode provides remote command backwards compatibility for the 8560 series of spectrum analyzers, known as legacy spectrum analyzers.

NOTE After changing into or out of RLC mode, allow a 1 second delay before sending any subsequent commands.

If you are using the Help feature, this mode must be currently active to access its detailed information. If it is not active, exit the Help feature (Esc key), select the mode, and re-access Help.

Key Path	Mode
Example	INST:SEL RLC Or INST:NSEL 266
Initial S/W Revision	Prior to A.02.00
Help Map ID	3585

SCPI Language Compatibility

The SCPI Language Compatibility mode provides remote language compatibility for SCPI based instruments, such as the Rohde and Schwartz FSP and related series of spectrum analyzers.

NOTE After changing into or out of this mode, allow a 1 second delay before sending any subsequent commands.

If you are using the Help feature, this mode must be currently active to access its detailed information. If it is not active, exit the Help feature (Esc key), select the mode, and re-access Help.

Key Path	Mode
Example	INST:SEL SCPILC Or INST:NSEL 270

Initial S/W Revision	A.06.00
Help Map ID	29993

89601 VSA

Selecting the 89601 VSA mode will start the 89600-Series VSA software application. The 89600 VSA software is powerful, PC-based software, offering the industry's most sophisticated general purpose and standards specific signal evaluation and troubleshooting tools for the R&D engineer. Reach deeper into signals, gather more data on signal problems, and gain greater insight.

- Over 30 general-purpose analog and digital demodulators ranging from 2FSK to 1024QAM
- Standards specific modulation analysis including:
 - Cell: GSM, cdma2000, WCDMA, TD-SCDMA and more
 - Wireless networking: 802.11a/b/g, 802.11n, 802.16 WiMAX (fixed/mobile), UWB
 - RFID
 - Digital satellite video and other satellite signals, radar, LMDS
- Up to 400K bin FFT, for the highest resolution spectrum analysis
- A full suite of time domain analysis tools, including signal capture and playback, time gating, and CCDF measurements
- Six simultaneous trace displays and the industry's most complete set of marker functions
- Easy-to-use Microsoft ® Windows ® graphical user interface

For more information see the Agilent 89600 Series VSA web site at www.agilent.com/find/89600

To learn more about how to use the 89600 VSA running in the X-Series, after the 89600 VSA application is running, open the 89600 VSA Help and open the "About Agilent X-Series Signal Analyzers (MXA/EXA) with 89600-Series Software" help topic.

Key Path	Mode
Example	INST:SEL VSA89601 INST:NSEL 101
Initial S/W Revision	Prior to A.02.00
Help Map ID	3556

Mode

Mode Setup

Accesses a menu to specify the parameters for the mode. These settings will be in effect for all the measurements in the current mode.

Key Path	Front-panel key
Initial S/W Revision	A.03.00

Device Type

Selects either a transmitter or an exciter as the device under test.

Key Path	Mode Setup
Mode	CMMB
Remote Command	[:SENSe] :RADio:STANdard:DEVIce TRANsmitter EXCiter [:SENSe] :RADio:STANdard:DEVIce?
Example	RAD:STAN:DEV TRAN RAD:STAN:DEV?
Couplings	In the Channel Power measurement, when changing the device, the limit of pass/fail is coupled as shown in the Table 1 below. In the ACP measurement, when changing the device, the measure method and pass/fail limit are coupled as shown in the Table 2 below.
Preset	TRANsmitter
State Saved	Saved in instrument state.
Range	Transmitter Exciter
Initial S/W Revision	A.03.00

Table 1: Device and Pass/Fail Limit Couplings

Measurement	Device	Pass/Fail Limit
Shoulder Attenuation (Channel Power)	Transmitter	≤-35dB
	Exciter	≤-50dB

Mode Setup

Table 2: Device and Measure Method Couplings in ACP Measurement

Measurement	Device	Measure Method	Pass/Fail Limit
ACP	Transmitter	<p>There are two measurement ranges as indicated in the figure below this table: Inside Adjacent Channel and Outside Adjacent Channel.</p> <p>1. Inside Adjacent Channel:</p> <p>(1) Offset Frequency: ± 8 MHz</p> <p>(2) Offset Integ BW: 8 MHz</p> <p>(3) Result: the maximum value of the Lower and Upper Offset Abs/Rel Power</p> <p>2. Outside Adjacent Channel:</p> <p>(1) Offset Frequency: ± 16 MHz, ± 24 MHz, ± 32 MHz</p> <p>(2) Offset Integ BW: 8 MHz</p> <p>(3) Result: the RMS value of the six Lower and Upper Offset Abs/Rel Power</p>	<p>Inside Adjacent Channel:</p> <p>Abs Limit ≤ 13 mW and Rel Limit ≤ -45 dB</p> <p>Outside Adjacent Channel:</p> <p>Abs Limit ≤ 13 mW or Rel Limit ≤ -60 dB</p>
	Exciter	<p>There is only one measurement range: Inside Adjacent Channel.</p> <p>Inside Adjacent Channel:</p> <p>(1) Offset Frequency: ± 8 MHz</p> <p>(2) Offset Integ BW: 8 MHz</p> <p>(3) Result: the maximum value of the Lower and Upper Offset Abs/Rel Power</p>	<p>Inside Adjacent Channel:</p> <p>Rel Limit < -50 dB</p>

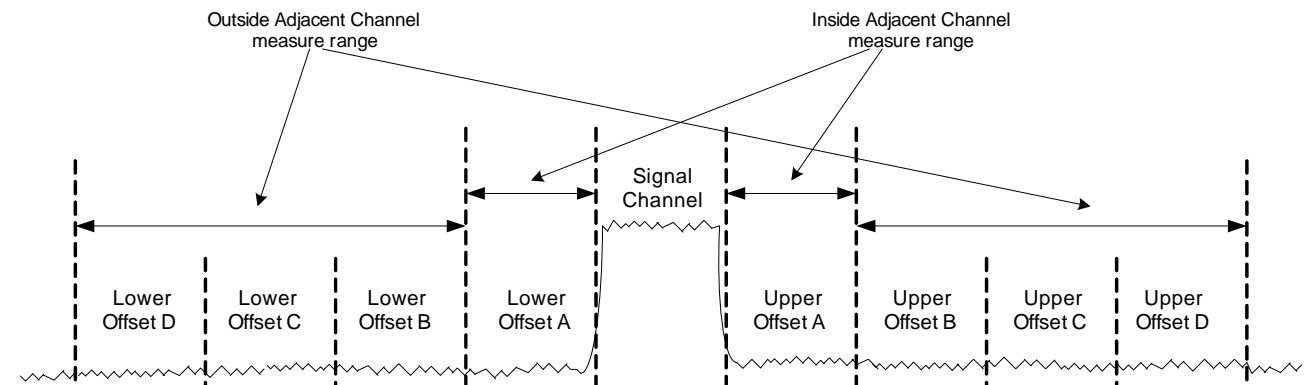

Noise Reduction

Noise Reduction accesses a menu for configuring the noise compensation of the instrument. This menu only appears in models that support Noise Reduction.

Key Path	Mode Setup
Initial S/W Revision	A.04.00

Noise Floor Extension

Turns on the **Noise Floor Extension** function. When this function is On, the expected noise power of the analyzer (derived from a factory calibration) is subtracted from the trace data. When **Noise Floor Extension** is On, it will usually reduce the apparent noise level by about 10 dB in low band, and 8 dB in high band (>~3.6 GHz).

Noise Floor Extension works with any RBW, VBW, detector, any setting of Average Type, any amount of trace averaging, and any signal type. It is ineffective when the trace is not smoothed (smoothing processes include narrow VBWs, trace averaging, and long sweep times with the detector set to Average or Peak). It works best with extreme amounts of smoothing. It works best with the average detector, with the Average Type set to Power.

In those cases where the cancellation is ineffective, it nonetheless has no undesirable side-effects. There is no significant speed impact to having **Noise Floor Extension** on.

The best accuracy is achieved when substantial smoothing occurs in each point before trace averaging. Thus, when using the average detector, results are better with long sweep times and fewer trace averages. When using the sample detector, the VBW filter should be set narrow with less trace averaging, instead of a wide VBW filter with more trace averaging.

See [“More Information” on page 1143](#).

Key Path	Mode Setup, Noise Reduction
Scope	Meas Global
Remote Command	[:SENSE] :CORRection:NOISe:FLOOr ON OFF 1 0 [:SENSE] :CORRection:NOISe:FLOOr?
Example	CORR:NOIS:FLO ON
Dependencies	In models that do not support Noise Floor Extension, the SCPI command will be accepted without error but will have no effect.
Preset	Unaffected by Mode Preset. Turned off by Restore Mode Defaults.
State Saved	No
Initial S/W Revision	A.04.00

More Information

The analyzer is characterized in the factory (or during a field calibration) with a model of the noise, referred to the input mixer, versus frequency in each band and path combination. Bands are 0 (low band)

Mode Setup

and 1 through 4 (high band) in a 26.5 GHz instrument, for example. Paths include normal paths, preamp paths, the electronic attenuator, etc.

In most band/path combinations, the noise can be well characterized based on just two parameters and the analyzer frequency response before compensation for frequency-dependent losses.

After the noise density at the input mixer is estimated, the effects of the input attenuator, RBW, detector, etc. are computed to get the estimated input-port-referred noise level.

In the simplest case, the measured power (signal plus analyzer noise) in each display point (bucket) is compensated by subtracting the estimated noise power, leaving just the signal power. This is the operation when the detector is Average and the Average Type is set to Power.

In other cases, operation is often not quite as good but still highly effective. With peak detection, the noise floor is estimated based on the RBW and the duration of the bucket using the same equations used in the noise marker function. The voltage of the noise is subtracted from the voltage of the observed signal-plus-noise measurement to compute the estimated signal voltage. The peak detector is one example of processing that varies with detector to give good estimates of the signal level without the analyzer noise.

For best operation, the average detector and the power scale are recommended, as already stated. Peak detection for pulsed-RF can still give excellent effectiveness. FFT analysis does not work well, and does not do NFE well, with pulsed-RF signals, so this combination is not recommended. Negative peak detection is not very useful, either. Sample detection works well, but is never better than the average detector because it doesn't smooth as well. The Normal detector is a combination of peak and negative peak behaviors, and works about as well as these.

For best operation, extreme smoothing is desirable, as already stated. Using narrow VBWs works well, but using very long bucket durations and the average detector works best. Reducing the number of trace points will make the buckets longer.

For best operation, the power scale (Average Type = Power) is optimum. When making CW measurements in the presence of noise without NFE, averaging on the decibel scale has the advantage of reducing the effect of noise. When using NFE, the NFE does an even better job than using the log scale ever could. Using NFE with the log scale is not synergistic, though; NFE with the power scale works a little better than NFE with log averaging type.

Restore Mode Defaults

Resets the state for the currently active mode by resetting the mode persistent settings to their factory default values, clearing mode data and by performing a Mode Preset.

Key Path	Mode Setup
Initial S/W Revision	A.03.00

Peak Search

Pressing the Peak Search key displays the Peak Search menu and places the selected marker on the trace point with the maximum y-axis value for that marker's trace. The Peak Search features allow you to define specific search criteria to determine which signals can be considered peaks, excluding unwanted signals from the search.

See [“More Information” on page 1145](#).

Key Path	Front-panel key
Remote Command	:CALCulate:MARKer [1] 2 3 4 5 6 7 8 9 10 11 12 :MAXimum
Example	<p>CALC:MARK2:MAX performs a peak search using marker 2.</p> <p>CALC:MARK2:Y? queries the marker amplitude (Y-axis) value for marker 2.</p> <p>CALC:MARK2:X? queries the marker frequency or time (X-axis) value for marker 2.</p> <p>SYST:ERR? can be used to query the errors to determine if a peak is found. The error -200 will be returned after an unsuccessful search.</p>
Notes	Sending this command selects the subopcoded marker.
Initial S/W Revision	Prior to A.02.00

More Information

If **Same as “Next Peak” Criteria** is selected, and either **Pk Excursion** or **Pk Threshold** are on, a signal must meet those criteria. If no valid peak is found, a message is generated. And then the marker is not moved. When **Highest Peak** is on, or both **Pk Excursion** and **Pk Threshold** are off, the marker is always placed at the point on the trace with the maximum y-axis value, even if that point is on the very edge of the trace (exception: negative frequencies and signals close to the LO are not searched at all).

Pressing Peak Search with the selected marker off causes the selected marker to be set to **Normal** at the center of the screen, then a peak search is immediately performed.

Pressing the front panel Peak Search key always does a peak search. Occasionally, you may need to get to the Peak Search menu key functions without doing a peak search. You can do this by first accessing the Peak Search menu. Then go to the other menus that you need to access. Finally, you can get back to the Peak Search key menu by using the front panel Return key and pressing it as many times as required to navigate back through the previously accessed menus until you get back to the Peak Search menu.

Next Peak

Pressing Next Peak moves the selected marker to the peak that has the next highest amplitude less than the marker's current value. Only peaks which meet all enabled peak criteria are considered. If there is no valid peak lower than the current marker position, an error is generated and the marker is not moved.

Peak Search

If the selected marker was off, then it is turned on as a normal marker and a peak search is performed.

Key Path	Peak Search
Remote Command	:CALCulate:MARKer [1] 2 3 4 5 6 7 8 9 10 11 12 :MAXimum:NEXT
Example	CALC:MARK2:MAX:NEXT Selects marker 2 and moves it to the peak that is closest in amplitude to the current peak, but the next lower value.
Notes	Sending this command selects the subopcoded marker.
State Saved	Not part of saved state.
Initial S/W Revision	Prior to A.02.00

Next Pk Right

Pressing Next Pk Right moves the selected marker to the nearest peak right of the current marker which meets all enabled peak criteria. If there is no valid peak to the right of the current marker position, an error is generated and the marker is not moved.

If the selected marker was off, then it is turned on as a normal marker and a peak search is performed.

Key Path	Peak Search
Remote Command	:CALCulate:MARKer [1] 2 3 4 5 6 7 8 9 10 11 12 :MAXimum:RIGHT
Example	CALC:MARK2:MAX:RIGHT Selects marker 2 and moves it to the next peak to the right of the current marker position.
Notes	Sending this command selects the subopcoded marker.
State Saved	Not part of saved state.
Initial S/W Revision	Prior to A.02.00

Next Pk Left

Pressing Next Pk Left moves the selected marker to the nearest peak left of the current marker which meets all enabled peak criteria. If there is no valid peak to the left of the current marker position, an error is generated and the marker is not moved.

If the selected marker was off, then it is turned on as a normal marker and a peak search is performed.

Key Path	Peak Search
Remote Command	:CALCulate:MARKer [1] 2 3 4 5 6 7 8 9 10 11 12 :MAXimum:LEFT
Example	CALC:MARK2:MAX:LEFT selects marker 2 and moves it to the next peak to the left of the current marker position.
State Saved	Not part of saved state.

Initial S/W Revision	Prior to A.02.00
----------------------	------------------

Marker Delta

Performs the same function as the Delta 1-of-N selection key in the Marker menu. Basically this sets the control mode for the selected marker to Delta mode. See the Section [““Marker” on page 1039”](#) for the complete description of this function. The key is duplicated here in the Peak Search Menu to allow you to conveniently perform a peak search and change the marker’s control mode to Delta without having to access two separate menus.

Key Path	Peak Search or Marker
Notes	Whenever the selected marker is in Delta mode and you are in the Peak Search menu, the Marker Delta key should be highlighted and the active function for setting its delta value turned on.
Initial S/W Revision	Prior to A.02.00

Mkr->CF

Assigns the selected marker’s frequency to the Center Frequency setting. See the Section [““Marker To” on page 1079”](#) for the description of this function. The key is duplicated here in the Peak Search Menu to allow you to conveniently perform a peak search and marker to CF without having to access two separate menus.

Key Path	Peak Search or Marker ->
Dependencies	Same as specified under Marker To
Initial S/W Revision	Prior to A.02.00

Mkr->Ref Lvl

Assigns the selected marker’s level to the Reference Level setting. See the Section [““Marker To” on page 1079”](#) for the description of this function. The key is duplicated here in the Peak Search Menu to allow you to conveniently perform a peak search and marker to RL without having to access two separate menus.

Key Path	Peak Search or Marker ->
Dependencies	Same as specified under Marker To
Initial S/W Revision	Prior to A.02.00

Peak Criteria

Pressing this key opens the Peak Criteria menu and allows you to adjust the Pk Threshold and Pk Excursion parameters used for peak search functions.

For a signal to be identified as a peak it must meet certain criteria. Signals in the negative frequency

Peak Search

range and signals very close to 0 Hz are ignored. If either the peak excursion or peak threshold functions are on, then the signal must satisfy those criteria before being identified as a peak.

When peak excursion and peak threshold are both off:

Peak Search, Continuous Peak Search, and maximum part of **Pk-Pk Search** will search the trace for the point with the highest y-axis value which does not violate the LO feedthrough rules. A rising and falling slope are not required for these three peak search functions.

The remaining search functions **Next Peak, Next Pk Right**, etc. will only consider trace points which have a rising and falling slope on the left and right respectively.

Key Path	Peak Search
Initial S/W Revision	Prior to A.02.00

“Peak Search” Criteria

This menu lets you decide what kind of search you want to do when the Peak Search key is pressed (or the equivalent SCPI command sent).

Note that there are two “types” of peak search functions. One type is the “Peak Search” type, the other type is the “Next Peak” type. “Next Peak” searches (for example, Next Peak, Next Pk Left, Next Pk Right) are always checked using the Excursion and Threshold criteria as long as these criteria are On. The “Peak Search” type of search, simply finds the highest point on the trace. However you can change the “Peak Search” type of search so that it also uses the Excursion and Threshold criteria. This allows you to find the Maximum point on the trace that also obeys the Excursion and/or Threshold criteria.

When **Highest Peak** is selected, pressing **Peak Search** simply finds the highest peak on the marker’s trace. If **Same as “Next Peak” Criteria** is selected, then the search is also forced to consider the Excursion and Threshold found under the “**Next Peak**” **Criteria** menu.

Key Path	Peak Search, Peak Criteria
Remote Command	:CALCulate:MARKer:PEAK:SEARch:MODE MAXimum PARAmeter :CALCulate:MARKer:PEAK:SEARch:MODE?
Notes	MAXimum corresponds to the Highest Peak setting PARAmeter corresponds to the Same as “Next Peak” Criteria setting
Preset	MAXimum
State Saved	Saved in instrument state.
Readback line	Current state
Initial S/W Revision	Prior to A.02.00

Highest Peak

When this key is selected, pressing the Peak Search key or issuing the equivalent SCPI command finds the maximum point on the trace, subject to the peak-search qualifications. This also affects the Peak

Search half of Pk-Pk search and the Continuous Peak Search.

Key Path	Peak Search, Peak Criteria, “Peak Search” Criteria
Example	CALC:MARK:PEAK:SEAR:MODE MAX
Readback	Highest Peak
Initial S/W Revision	Prior to A.02.00

Same as “Next Peak” Criteria

When this key is selected, pressing the Peak Search key or issuing the equivalent SCPI command finds the maximum point on the trace, but subject to the Excursion and Threshold set under the Next Peak Criteria menu. The search is, of course, also subject to the peak-search qualifications. This also affects the Peak Search half of Pk-Pk search and the Continuous Peak Search.

Key Path	Peak Search, Peak Criteria, “Peak Search” Criteria
Example	CALC:MARK:PEAK:SEAR:MODE PAR
Readback	Use Excurs & Thr
Initial S/W Revision	Prior to A.02.00

“Next Peak” Criteria

This key opens up a menu which allows you to independently set the Peak Excursion and Peak Threshold and turn them on and off.

Key Path	Peak Search, Peak Criteria
Initial S/W Revision	Prior to A.02.00

Pk Excursion

Turns the peak excursion requirement on/off and sets the excursion value. The value defines the minimum amplitude variation (rise and fall) required for a signal to be identified as peak. For example, if a value of 6 dB is selected, peak search functions like the marker Next Pk Right function move only to peaks that rise and fall 6 dB or more.

When both Pk Excursion and Pk Threshold are on, a signal must rise above the Pk Threshold value by at least the **Peak Excursion** value and then fall back from its local maximum by at least the **Peak Excursion** value to be considered a peak.

NOTE In the event that a sequence of trace points with precisely the same values represents the maximum, the leftmost point is found.

See [“More Information” on page 1150](#).

Key Path	Peak Search, Peak Criteria, “Next Peak” Criteria
----------	---

Peak Search

Remote Command	:CALCulate:MARKer:PEAK:EXCursion <rel_ampl> :CALCulate:MARKer:PEAK:EXCursion? :CALCulate:MARKer:PEAK:EXCursion:STATE OFF ON 0 1 :CALCulate:MARKer:PEAK:EXCursion:STATE?
Example	:CALC:MARK:PEAK:EXC:STAT ON :CALC:MARK:PEAK:EXC 30 DB sets the minimum peak excursion requirement to 30 dB
Dependencies	Available only when Y axis unit is amplitude units, otherwise grayed out.
Couplings	Whenever you adjust the value of Pk Excursion (with the knob, step keys, or by completing a numeric entry), and Peak Threshold is turned ON, the Peak Threshold Line and the Peak Excursion Region are displayed.
Preset	6.0 dB ON
Preset	6.0 dB ON
State Saved	Saved in instrument state
Min	0.0 dB
Max	100.0 dB
Initial S/W Revision	Prior to A.02.00

More Information

If two signals are very close together and the peak excursion and threshold criteria are met at the outside edges of the combined signals, this function finds the highest of these two signals as a peak (or next peak). However, if a signal appears near the edge of the screen such that the full extent of either the rising or falling edge cannot be determined, and the portion that is on screen does not meet the excursion criteria, then the signal cannot be identified as a peak.

When measuring signals near the noise floor, you can reduce the excursion value even further to make these signals recognizable. To prevent the marker from identifying noise as signals, reduce the noise floor variations to a value less than the peak-excursion value by reducing the video bandwidth or by using trace averaging.

Pk Threshold

Turns the peak threshold requirement on/off and sets the threshold value. The peak threshold value defines the minimum signal level (or min threshold) that the peak identification algorithm uses to recognize a peak.

When both Pk Excursion and Pk Threshold are on, a signal must rise above the Pk Threshold value by at least the **Peak Excursion** value and then fall back from its local maximum by at least the **Peak Excursion** value to be considered a peak.

For example, if a threshold value of -90 dBm is selected, the peak search algorithm will only consider

signals with amplitude greater than the –90 dBm threshold. If a threshold value of –90 dBm is selected, and **Peak Excursion** is **On** and set to 6 dB, the peak search algorithm will only consider signals with amplitude greater than the –90 dBm threshold which rise 6 dB above the threshold and then fall back to the threshold.

Key Path	Peak Search, Peak Criteria, “Next Peak Criteria”
Remote Command	:CALCulate:MARKer:PEAK:THReshold <ampl> :CALCulate:MARKer:PEAK:THReshold? :CALCulate:MARKer:PEAK:THReshold:STATe OFF ON 0 1 :CALCulate:MARKer:PEAK:THReshold:STATe?
Example	CALC:MARK:PEAK:THR:STAT ON turns on the threshold criterion. CALC:MARK:PEAK:THR –60 dBm sets the threshold to –60 dBm.
Dependencies	When Ref Level Offset changes, Peak Threshold must change by the same amount.
Preset	–90.0 dBm ON
State Saved	Saved in instrument state.
Min	The current displayed Ref Level – 200 dB. The current displayed Ref Level is the current Ref Level, offset by the Ref Level Offset.
Max	The current displayed Ref Level. This means the current Ref Level, offset by the Ref Level Offset.
Initial S/W Revision	Prior to A.02.00
Default Unit	depends on the current selected Y axis unit

Pk Threshold Line

Turns the peak threshold line on or off. Preset state is off. No equivalent SCPI command.

See “[More Information](#)” on page 1151.

Dependencies	If Peak Threshold is Off and the Peak Threshold line is turned on, it should turn on Peak Threshold.
Initial S/W Revision	Prior to A.02.00

More Information

The Peak Threshold line is green and has the value of the peak threshold (for example, “–20.3 dBm”) written above its right side, above the line itself. If Peak Excursion is ON it shows on the left side as a region above the Peak Threshold line. As with all such lines (Display Line, Trigger Level line, etc) it is drawn on top of all traces.

Peak Search

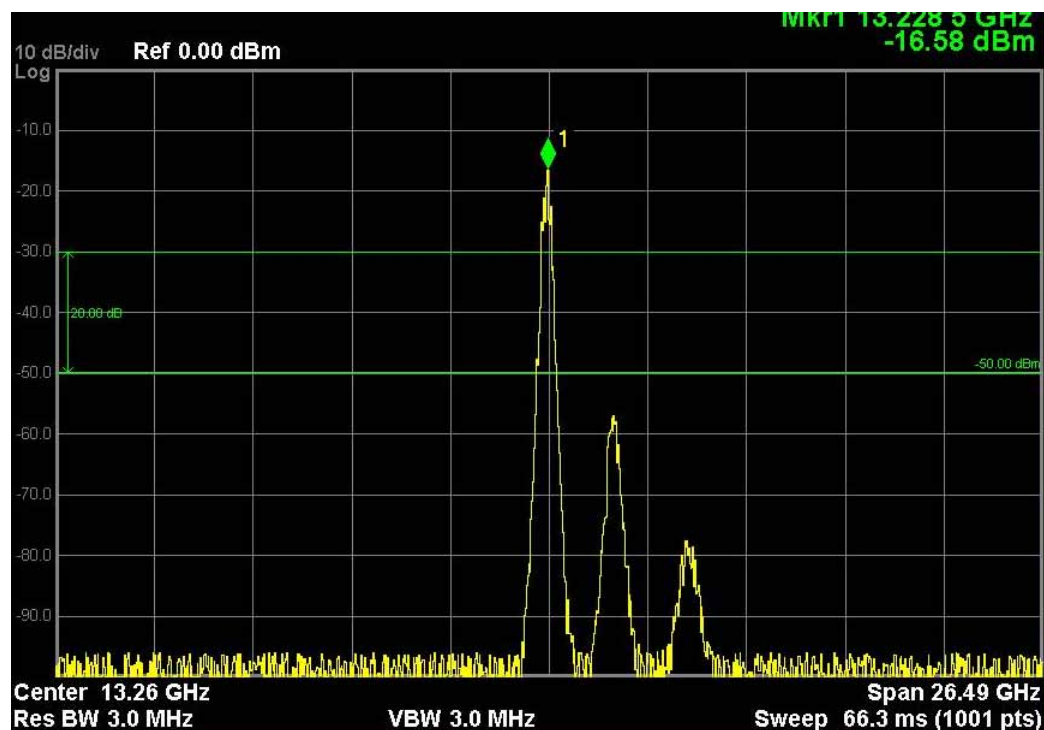

This function is automatically set to ON (thus turning on the Peak Threshold line) whenever the value of Peak Threshold or Peak Excursion becomes the active function, unless Peak Threshold is OFF. It is automatically set to OFF whenever Peak Threshold is set to OFF. Manually turning it ON automatically turns on Pk Threshold.

The Peak Excursion part is on whenever the Pk Threshold part is on, unless Peak Excursion is OFF.

Peak Table

Opens the Peak Table menu.

The Peak Table provides a displayed list of up to 20 signal peaks from the selected trace. If more than one trace window is displayed, the selected trace in the selected window is used. If there are more than 20 signals which meet the peak search criteria, only the 20 highest peaks are listed.

The Peak Table is updated after each sweep. The list of peaks in the Peak Table can be ordered either by ascending frequency or by descending amplitude. In either case, the entire trace is first evaluated and the 20 highest peaks are selected for inclusion in the list. After the peaks are selected, they are then sorted and displayed according to the Peak Sort setting.

Key Path	Peak Search
Initial S/W Revision	Prior to A.02.00

Peak Table On/Off

Turns Peak Table on/off. When turned on, the display is split into a measurement window and a peak table display window.

Turning the Peak Table on turns the Marker Table off and vice versa.

Key Path	Peak Search, Peak Table
Remote Command	:CALCulate:MARKer:PEAK:TABLE:STATe OFF ON 0 1 :CALCulate:MARKer:PEAK:TABLE:STATe?
Example	CALC:MARK:PEAK:TABL:STAT ON Turns on and displays the peak table.
Dependencies	When the Peak Table turns on, if Peak Threshold is On then it becomes the active function.
Preset	OFF
State Saved	Saved in instrument state.
Initial S/W Revision	Prior to A.02.00

Peak Sort

Sets the peak table sorting routine to list the peaks in order of descending amplitude or ascending frequency. The remote command can also be used to sort the peaks found using the :CALCulate:DATA:PEAKs command.

Key Path	Peak Search, Peak Table
Remote Command	:CALCulate:MARKer:PEAK:SORT FREQuency AMPLitude :CALCulate:MARKer:PEAK:SORT?
Example	CALC:MARK:PEAK:SORT AMPL Sets sorting routine to list peaks in order of descending amplitude. CALC:MARK:PEAK:SORT?
Preset	AMPLitude
Preset	AMPLitude
State Saved	Saved in instrument state.
Backwards Compatibility SCPI	:TRACe:MATH:PEAK:SORT
Backwards Compatibility SCPI	The old TRAC:MATH:PEAK:SORT command/query used in ESA is still supported for backward compatibility.
Initial S/W Revision	Prior to A.02.00

Peak Readout

Shows up to twenty signal peaks as defined by the setting:

All (ALL) - lists all the peaks defined by the peak criteria, in the current sort setting.

Above Display Line (GTDLLine) - lists the peaks that are greater than the defined display line, and that meet the peak criteria. They are listed in the current sort order.

Below Display Line (LTDLLine) - lists the peaks that are less than the defined display line, and that meet

Peak Search

the peak criteria. They are listed in the current sort order.

If the peak threshold is defined and turned on, then the peaks must meet this peak criteria in addition to the display line requirements.

See “[More Information](#)” on page 1154.

Key Path	Peak Search, Peak Table
Remote Command	:CALCulate:MARKer:PEAK:TABLE:READout ALL GTDLine LTDLine :CALCulate:MARKer:PEAK:TABLE:READout?
Example	CALC:MARK:PEAK:TABL:READ GTDL
Dependencies	Turning Display Line off forces Readout to ALL
Preset	All
Preset	All
State Saved	Saved in instrument state.
Readback line	1-of-N selection
Initial S/W Revision	Prior to A.02.00

More Information

If the Display Line (see the Section “View/Display”) is turned on, the Peak Table can be selected to include all peaks, only those above the Display Line, or only those below the Display Line. See Figures 1–2 and 1–3 to understand what happens if both Display Line and Pk Threshold are turned on.

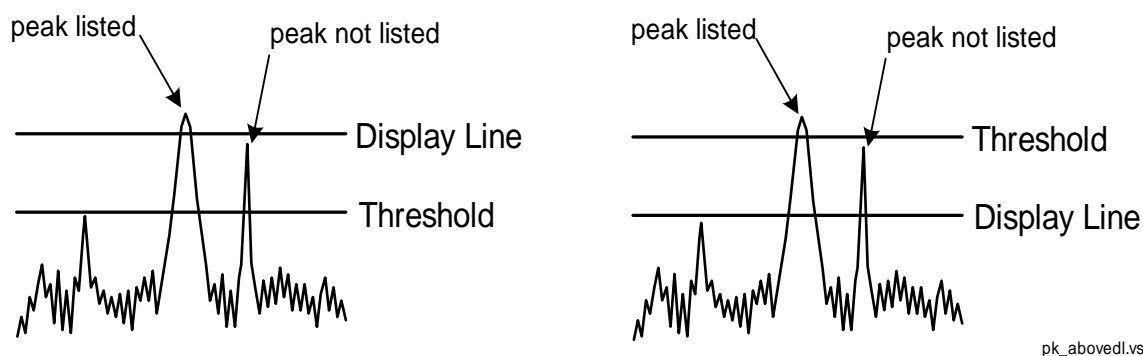

Figure 1- 2Above Display Line Peak Identification

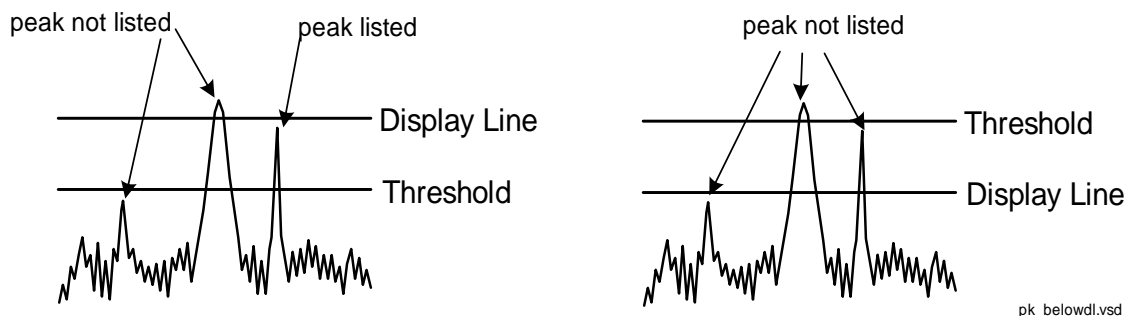

Figure 1- 3Below Display Line Peak Identification

All

Sets the peak table to display the 20 highest peaks in the order specified by the current Peak Sort setting. If the Peak Criteria are turned on, then only peaks that meet the defined Pk Excursion and Pk Threshold values will be found.

Key Path	Peak Search, Peak Table, Peak Readout
Example	CALC:MARK:PEAK:TABL:READ ALL
Notes	Auto return after pressed
Readback	All
Initial S/W Revision	Prior to A.02.00

Above Display Line

Sets the peak table to display only the 20 highest peaks above the display line in the order specified by the current Sort setting. If the Peak Criteria are turned on, then only peaks that meet the defined criteria will be found. If the display line is not already on, it is turned on (it has to be on or it cannot be used to exclude peaks).

Key Path	Peak Search, Peak Table, Peak Readout
Example	CALC:MARK:PEAK:TABL:READ GTDL
Notes	Auto return after pressed
Dependencies	When Above Display Line is selected, Display Line is turned on and becomes the active function.
Readback	Above DL
Initial S/W Revision	Prior to A.02.00

Below Display Line

Sets the peak table to display only the 20 highest peaks below the display line as defined by the peak in

Peak Search

the order specified by the current Sort setting. If the Peak Criteria are turned on, then only peaks that meet the defined criteria will be found. If the display line is not already on, it is turned on (it has to be on or it cannot be used to exclude peaks).

Key Path	Peak Search, Peak Table, Peak Readout
Example	CALC:MARK:PEAK:TABL:READ LTDL
Notes	Auto return after pressed
Dependencies	When Below Display Line is selected, Display Line is turned on and becomes the active function.
Readback	Below DL
Initial S/W Revision	Prior to A.02.00

Continuous Peak Search

Turns Continuous Peak Search on or off. When Continuous Peak Search is on, a peak search is automatically performed for the selected marker after each sweep. The rules for finding the peak are exactly the same as for **Peak Search**, including the use of the peak criteria rules. If no valid peak is found, a warning is generated after each sweep.

See [“More Information” on page 1157](#).

Key Path	Peak Search
Remote Command	:CALCulate:MARKer [1] 2 3 4 5 6 7 8 9 10 11 12 :CPSearch [:STATe] ON OFF 1 0 :CALCulate:MARKer [1] 2 3 4 5 6 7 8 9 10 11 12 :CPSearch [:STATe] ?
Example	CALC:MARK:CPS ON Turns on Continuous Peak Search.
Notes	Sending this command selects the subcoded marker
Couplings	The Continuous Peak Search key is grayed out when the selected marker is a Fixed marker. Also, if Continuous Peak Search is on and the selected marker becomes a fixed marker, then Continuous Peak Search is turned off and the key grayed out. Signal Track and Continuous Peak Search are mutually exclusive so if Signal Track is on, Continuous Peak Search will be grayed out and vice versa.
Preset	Mode Preset
State Saved	Saved in instrument state.
Status Bits/OPC dependencies	The Measuring bit should remain set while this command is operating and should not go false until the marker position has been updated.
Initial S/W Revision	Prior to A.02.00

More Information

When Continuous Peak Search is turned on a peak search is immediately performed and then is repeated after each sweep. If Continuous Peak Search is turned on with the selected marker off, the selected marker is set to **Normal** at the center of the screen, and then a peak search is immediately performed and subsequently repeated after each sweep.

When in Continuous Peak Search, *OPC will not return true, nor will READ or MEASure return any data, until the sweep is complete and the marker has been re-peaked. Note further that if the analyzer is in a measurement such as averaging, and Continuous Peak Search is on, the entire measurement will be allowed to complete (i.e., all the averages taken up to the average number) before the repeak takes place, and only THEN will *OPC go true and READ or MEASure return data.

Note that this function is not the “Continuous Peak” function found in some other instruments. That function was designed to track the signal; this function simply does a Peak Search after each sweep.

When Continuous Peak Search is turned on for a marker, a little “hat” is placed above the marker.



Pk-Pk Search

Finds and displays the amplitude and frequency (or time, if in zero span) differences between the highest and lowest y-axis value. It places the selected marker on the minimum value on its selected trace. And it places that marker's reference marker on the peak of its selected trace. This function turns on the reference marker and sets its mode to **Fixed** if it is not already on. (These markers may be on two different traces.)

The rules for finding the maximum peak are exactly the same as for **Peak Search**, including the use of the peak criteria rules. However, the minimum trace value is not required to meet any criteria other than being the minimum y-axis value in the trace.

When Pk-Pk Search is successful, a message is displayed on the message line.

If the selected marker is off, a delta type marker is turned on and the peak-to-peak search is done. If the selected marker is on, but it is not a delta marker, then it is changed to delta which turns on the reference

Peak Search

marker if needed, and then it performs the peak-to-peak function.

Key Path	Peak Search
Remote Command	:CALCulate:MARKer [1] 2 3 4 5 6 7 8 9 10 11 12 :PTPeak
Example	CALC:MARK:PTP CALC:MARK:Y? queries the delta amplitude value for marker 1.
Notes	Turns on the Marker Δ active function.
Notes	Sending this command selects the subopcoded marker.
Dependencies	Pk-Pk Search is grayed out when Coupled Markers is on.
Couplings	The selected marker becomes a delta marker if not already in delta mode.
State Saved	Not part of saved state.
Initial S/W Revision	Prior to A.02.00

Min Search

Moves the selected marker to the minimum y-axis value on the current trace. Minimum (negative) peak searches do not have to meet the peak search criteria. It just looks for the lowest y-axis value. If the selected marker is Off, it is turned on before the minimum search is performed.

Key Path	Peak Search
Remote Command	:CALCulate:MARKer [1] 2 3 4 5 6 7 8 9 10 11 12 :MINimum
Example	CALC:MARK:MIN selects marker 1 and moves it to the minimum amplitude value.
Notes	Sending this command selects the subopcoded marker.
State Saved	Not part of saved state.
Initial S/W Revision	Prior to A.02.00

Peak Data Query (RemoteCommand Only)

This command works the same way in this and many other measurements, so it is documented in the Common Measurement Functions section.. For details about this key, see [“Calculate Peaks of Trace Data \(Remote Command Only\)” on page 1092.](#)

Recall

Most of the functions under this key work the same way in many measurements, so they are documented in the Utility Functions section. For details about this key, see [“Recall” on page 153](#).

The Amplitude Correction Import Data function under Recall is documented here.

Amplitude Correction

This key selects the Amplitude Corrections as the data type to be imported. When pressed a second time, it brings up the Select Menu, which lets you select the Correction into which the data will be imported.

Amplitude Corrections are fully discussed in the documentation of the Input/Output key, under the Corrections softkey.

A set of preloaded Corrections files can be found in the directory

/My Documents/ EMC Limits and Ampcor.

Under this directory, the directory called Ampcor (Legacy Naming) contains a set of legacy corrections files, generally the same files that were supplied with older Agilent EMI analyzers, that use the legacy suffixes .ant, .oth, .usr, and .cbl, and the old 8-character file names. In the directory called Ampcor, the same files can be found, with the same suffixes, but with longer, more descriptive filenames.

When the Amplitude Correction is an Antenna correction and the Antenna Unit in the file is not **None**, the Y Axis Unit setting will change to match the Antenna Unit in the file.

Key Path	Recall, Data
Mode	SA EDGE GSM
Remote Command	:MMEMory:LOAD:CORRection 1 2 3 4, <filename>
Example	:MMEM:LOAD:CORR 2 "myAmpcor.csv" recalls the Amplitude Correction data from the file myAmpcor.csv in the current directory to the 2nd Amplitude Correction table, and turns on Correction 2. The default path is My Documents\amplitudeCorrections.

Recall

Dependencies	<p>Only the first correction array (Correction 1) supports antenna units. This means that a correction file with an Antenna Unit can only be loaded into the Corrections 1 register. Consequently only for Correction 1 does the dropdown in the Recall dialog include .ant, and if an attempt is made to load a correction file into any other Correction register which DOES contain an antenna unit, a Mass Storage error is generated.</p> <p>Corrections are not supported by all Measurements. If in a Mode in which some Measurements support it, this key will be grayed out in measurements that do not. The key will not show at all if no measurements in the Mode support it.</p> <p>Errors are reported if the file is empty or missing, or if the file type does not match, or if there is a mismatch between the file type and the destination data type. If any of these occur during manual operation, the analyzer returns to the Import Data menu and the File Open dialog goes away.</p> <p>This key does not appear unless you have the proper option installed in your instrument. This command will generate an “Option not available” error unless you have the proper option installed in your instrument.</p>
Couplings	When a correction file is loaded from mass storage, it is automatically turned on (Correction ON) and Apply Corrections is set to On. This allows the user to see its effect, thus confirming the load.
Readback	selected Correction
Backwards Compatibility SCPI	<p>For backwards compatibility, the following parameters syntax is supported: :MMEMory:LOAD:CORRection ANTenna CABLe OTHer USER, <filename></p> <p>ANTenna maps to 1, CABLe maps to 2, OTHer maps to 3 and USER maps to 4</p>
Initial S/W Revision	A.02.00

Amplitude Correction 1, 2, 3, 4

These keys let you select which Correction to import the data into. Once selected, the key returns back to the Import Data menu and the selected Correction number is annotated on the key. The next step is to select the Open key in the Import Data menu.

Antenna corrections are a particular kind of Amplitude Corrections – they are distinguished in the corrections file by having the Antenna Unit set to a value other than None. Only Correction 1 supports Antenna Units.

Key Path	Recall, Data, Amplitude Correction
Notes	auto return
Dependencies	Only Correction 1 may be used to load a Correction that contains an Antenna Unit other than None
Preset	not part of Preset, but is reset to Correction 1 by Restore Input/Output Defaults; survives shutdown

State Saved	The current Correction number is saved in instrument state
Initial S/W Revision	A.02.00

Recall

Restart

The Restart function restarts the current sweep, or measurement, or set of averaged/hold sweeps or measurements. If you are Paused, pressing Restart does a Resume.

The Restart function is accessed in several ways:

- Pressing the Restart key
- Sending the remote command INIT:IMMEDIATE
- Sending the remote command INIT:RESTART

Key Path	Front-panel key
Remote Command	:INITiate[:IMMEDIATE]
Example	:INIT:IMM
Notes	:INITiate:REStart :INITiate:IMMEDIATE Either of the above commands perform exactly the same function.
Couplings	Resets average/hold count k. For the first sweep overwrites all active (update=on) traces with new current data. For application modes, it resets other parameters as required by the measurement.
Status Bits/OPC dependencies	This is an Overlapped command. The STATUS:OPERation register bits 0 through 8 are cleared. The STATUS:QUESTionable register bit 9 (INTEgrity sum) is cleared. The SWEEPING bit is set. The MEASURING bit is set.
Initial S/W Revision	Prior to A.02.00

Remote Command	:INITiate:REStart
Example	:INIT:REST
Notes	:INITiate:REStart :INITiate:IMMEDIATE Either of the above commands perform exactly the same function.
Couplings	Resets average/hold count k. For the first sweep overwrites all active (update=on) traces with new current data. For application modes, it resets other parameters as required by the measurement.

Restart

Status Bits/OPC dependencies	This is an Overlapped command. The STATUS:OPERation register bits 0 through 8 are cleared. The STATUS:QUESTionable register bit 9 (INTegrity sum) is cleared. The SWEEPING bit is set. The MEASURING bit is set.
Initial S/W Revision	Prior to A.02.00

The **Restart** function first aborts the current sweep/measurement as quickly as possible. It then resets the sweep and trigger systems, sets up the measurement and initiates a new data measurement sequence with a new data acquisition (sweep) taken once the trigger condition is met.

If the analyzer is in the process of aligning when **Restart** is executed, the alignment finishes before the restart function is performed.

Even when set for Single operation, multiple sweeps may be taken when Restart is pressed (for example, when averaging/holding is on). Thus when we say that **Restart** "restarts a measurement," we may mean:

- It restarts the current sweep
- It restarts the current measurement
- It restarts the current set of sweeps if any trace is in Trace Average, Max Hold or Min Hold
- It restarts the current set of measurements if Averaging, or Max Hold, or Min Hold is on for the measurement
- depending on the current settings.

With **Average/Hold Number** (in **Meas Setup** menu) set to 1, or Averaging off, or no trace in Trace Average or Hold, a single sweep is equivalent to a single measurement. A single sweep is taken after the trigger condition is met; and the analyzer stops sweeping once that sweep has completed. However, with **Average/Hold Number** >1 and at least one trace set to **Trace Average, Max Hold, or Min Hold (SA Measurement)** or **Averaging on (most other measurements)**, multiple sweeps/data acquisitions are taken for a single measurement. The trigger condition must be met prior to each sweep. The sweep is stopped when the average count k equals the number N set for **Average/Hold Number**. A measurement average usually applies to all traces, marker results, and numeric results; but sometimes it only applies to the numeric results.

Once the full set of sweeps has been taken, the analyzer will go to idle state. To take one more sweep without resetting the average count, increment the average count by 1, by pressing the step up key while **Average/Hold Number** is the active function, or sending the remote command CALC:AVER:TCON UP.

Save

Most of the functions under this key work the same way in many measurements, so they are documented in the Utility Functions section. For details about this key, see [“Save” on page 170](#).

The Amplitude Correction Export Data function under Save is documented here.

Amplitude Correction

Pressing this key selects **Amplitude Corrections** as the data type to be exported. Pressing this key again brings up the Select Menu, which allows the user to select which **Amplitude Correction** to save.

Amplitude Corrections are fully discussed in the documentation of the Input/Output key, under the Corrections softkey.

Key Path	Save, Data
Remote Command	:MMEMory:STORe:CORRection 1 2 3 4, <filename>
Example	:MMEM:STOR:CORR 2 "myAmpcor.csv" saves Correction 2 to the file myAmpcor.csv on the current path. The default path is My Documents\amplitudeCorrections.
Notes	If the save is initiated via SCPI, and the file already exists, the file will be overwritten. Using the C: drive is strongly discouraged, since it runs the risk of being overwritten during an instrument software upgrade. Both single and double quotes are supported for any filename parameter over SCPI.
Dependencies	Corrections are not supported by all Measurements. If in a Mode in which some Measurements support it, this key will be grayed out in measurements that do not. The key will not show at all if no measurements in the Mode support it. This key will not appear unless you have the proper option installed in your instrument.
Readback	1 2 3 4
Backwards Compatibility SCPI	For backwards compatibility only, the following parameters syntax is supported: :MMEMory:STORe:CORRection ANTenna CABLe OTHer USER, <filename> ANTenna maps to 1, CABLe maps to 2, OTHer maps to 3 and USER maps to 4
Initial S/W Revision	A.02.00

Save

Correction Data File

A Corrections Data File contains a copy of one of the analyzer correction tables. Corrections provide a way to adjust the trace display for predetermined gain curves (such as for cable loss).

The first five lines are system-required header lines, and must be in the correct order.

Amplitude CorrectionData file type name
"Correction Factors for 11966E"File Description
"Class B Radiated"Comment
A.01.00.R0001,N9020AInstrument Version, Model Number
P13 EA3 UK6,01 Option List, File Format Version

Corrections files may include Antenna amplitude units. This amplitude unit in the Antenna Unit field is a conversion factor that is used to adjust the Y Axis Units of the current mode, if the mode supports Antenna Units. For more details on antenna correction data, refer to the Input/Output chapter, Corrections section.

The metadata required to properly import the correction data is:

- Frequency Unit for the x axis data
- Antenna Unit for the y axis data (not required)
- Frequency Interpolation algorithm – either Logarithmic or Linear

The data follows as comma separated X, Y pairs; one pair per line. The keyword "DATA" precedes the data.

For example, suppose you have an Antenna to correct for on an E4445A version A.01.00 R0011 and the correction data is:

- 0 dB at 200 MHz
- 17 dB at 210 MHz
- 14.8 dB at 225 MHz

Then the file will look like:

- Amplitude Correction
- "Correction Factors for 11966E"
- "Class B Radiated"
- A.01.00 R0011,N9020A
- P13 EA3 UK6,01
- Frequency Unit,MHz
- Antenna Unit,dBuV/m
- Frequency Interpolation,Linear
- DATA
- 200.000000,0.00

- 210.000000,17.00
- 225.000000,14.80

The choices for the 1 of N fields in the metadata are as follows:

- Frequency Unit: Hz, kHz, MHz, GHz
- Antenna Unit: dBuv/m, dBuA/m, dBG, dBpT, None
- Frequency Interpolation: Logarithmic, Linear

Amplitude Correction 1, 2, 3, 4

These keys let you pick which Correction to save. Once selected, the key returns back to the Export Data menu and the selected Correction number is annotated on the key.

The next step in the Save process is to select the Save As key in the Export Data menu.

Key Path	Save, Data, Amplitude Correction
Preset	Not part of a Preset, but is reset to Correction 1 by Restore Input/Output Defaults. Survives a shutdown.
Readback	1
Initial S/W Revision	A.02.00

Save

Single (Single Measurement/Sweep)

Sets the analyzer for Single measurement operation. The single/continuous state is Meas Global, so the setting will affect all the measurements. If you are Paused, pressing **Single** does a Resume.

Key Path	Front-panel key
Example	:INIT:CONT OFF
Notes	See Cont key description.
Initial S/W Revision	Prior to A.02.00

Single (Single Measurement/Sweep)

Source

This mode does not have any Source control functionality.

Key Path	Front-panel key
Initial S/W Revision	Prior to A.02.00

Span X-Scale

Activates the Span function and displays a menu of span functions.

Key Path	Front-panel key
Initial S/W Revision	Prior to A.02.00

Span

Changes the displayed frequency range symmetrically about the center frequency. While adjusting the Span the Center Frequency is held constant, which means that both Start Frequency and Stop Frequency will change.

Span also sets the frequency entry mode to Center/Span. In Center/Span mode, the center frequency and span values are displayed below the graticule, and the default active function in the Frequency menu is **Center Freq.**

While discussing the Span function we make the distinction between “swept spans” and “zero span”. We use the term “swept spans” to mean spans other than zero; recognizing that, because of this terminology, the user can be in what we call a “swept span” even while performing an FFT “sweep”.

While in swept spans, setting the span to 0 Hz through SCPI or the front panel numeric key pad puts the analyzer into zero span. However, using the Step keys and the RPG in swept spans, the Span can only go as far down as 10 Hz and cannot be set to zero.

While in zero span, setting the Span to a non-zero value through SCPI or Front Panel puts the analyzer in swept spans.

If the Span is set to a value greater than the maximum allowable span of the instrument, an error is generated indicating the data is out of range and was clipped to upper limit.

Key Path	Span X Scale
Remote Command	[:SENSe] :FREQuency:SPAN <freq> [:SENSe] :FREQuency:SPAN?
Example	FREQ:SPAN 2GHz sets the span to 2GHz FREQ:SPAN 0 Hz sets the span to 0 Hz and puts the instrument in Zero Span
Notes	Preset and Max values depend on the Hardware Options (503, 507, 508, 513, 526)

Span X-Scale

Dependencies	<p>If the electrical attenuator is enabled, any attempt to set Span such that the Stop Frequency would be >3.6 GHz results in an error. If the key is pressed, an advisory message is generated. If the equivalent SCPI command is sent, this same message is generated as part of a “-221, Settings conflict” warning.</p> <p>If Source Mode is set to Tracking, and the Span is therefore limited by the limits of the source, a warning message is generated, “Data out of range;clipped to source max/min” if these limits are exceeded. Note that for an external source, these limits can be affected by the settings of Source Numerator, Source Denominator and Power Sweep.</p>
Couplings	<p>Span affects RBW, sweep time, FFT & Sweep choice (including FFT Width, Phase Noise Optimization and ADC Dither auto couplings.)</p> <p>When operating in “swept span”:</p> <ul style="list-style-type: none"> • Any value of the Center Frequency or Span that is within the frequency range of the analyzer is allowed when the value is being set through the front panel numeric key pad or the SCPI command. The other parameter is forced to a different value if needed, to keep the Start and the Stop Frequencies within the analyzer’s frequency range • When using the knob or the step up/down keys or the UP DOWN keywords in SCPI, the value that is being changed i.e. the Center Frequency or Span, is limited so that the other parameter is not forced to a new value • The Span cannot be set to Zero by setting Start Frequency = Stop Frequency. The value of the last setting will be changed to maintain a minimum value of 10 Hz for the difference between start and stop frequencies.
Preset	<p>Depends on instrument maximum frequency:</p> <p>Option 503 (3 GHz models): 2.99 GHz</p> <p>Option 503 (3.6 GHz models): 3.59 GHz</p> <p>Option 507 (7 GHz models): 6.99 GHz</p> <p>Option 507 (7.5 GHz models): 7.49 GHz</p> <p>Option 508: 8.39 GHz</p> <p>Option 513: 13.59 GHz</p> <p>Option 526: 26.49 GHz</p>
State Saved	Saved in instrument state
Min	10 Hz unless entered directly, then 0 Hz is allowed, but nothing between 0 and 10 is ever allowed.

Max	Option 503 (3 GHz models): 3.08 GHz Option 503 (3.6 GHz models): 3.7 GHz Option 507 (7 GHz models): 7.1 GHz Option 507 (7.5 GHz models): 7.58 GHz Option 508: 8.5 GHz Option 513: 13.8 GHz Option 526: 27.0 GHz If the knob or step keys are being used, depends on the value of the other three interdependent parameters Center Frequency, Start Frequency, Stop Frequency Note that, if the Source Mode is set to Tracking, the effective instrument maximum Span may be limited by the source maximum frequency.
Status Bits/OPC dependencies	Overlapped if Signal Track is on (OPC shouldn't return or clear until the zooming has completed for the new span)
Initial S/W Revision	Prior to A.02.00
Default Unit	Hz

Full Span

Changes the frequency span of the analyzer to the Preset frequency span of the analyzer and sets the Frequency entry mode to Center/Span.

The span is dependent on the currently selected Input (see the Section “Input/Output”).

Pressing this key while in zero span puts the analyzer back in swept span.

Key Path	Span X Scale
Remote Command	[:SENSE] :FREQuency:SPAN:FULL
Example	FREQ:SPAN:FULL sets the span to full frequency range of the analyzer
Notes	n /a
Couplings	Turns off signal tracking (span zoom). It does NOT turn off the markers, nor the current active function.
Initial S/W Revision	Prior to A.02.00

Zero Span

Changes the displayed frequency span to 0 Hz. The horizontal axis changes to time rather than frequency. The amplitude displayed is the input signal level at the current center frequency. This is a time-domain mode that changes several measurement functions and couplings. The instrument behavior is similar to an oscilloscope with a frequency selective detector installed in front of the oscilloscope. See Application Note 150 for more information on how to use zero span.

Span X-Scale

You can enter Zero Span in several ways:

- Press the Zero Span key in Span
- Set Span=0 Hz
- Press last Span if the last span was 0

You cannot go to Zero Span by setting start freq = stop freq, or rolling span down with the RPG, that will limit you to 10 Hz

You can go back to Swept Span by setting Span to a nonzero value or pressing Last Span, assuming the last span was not also zero span.

Pressing Zero Span places the analyzer in Center/Span frequency entry mode.

The following table summarizes the differences between Zero Span and Swept Spans:

Zero Span	Swept Spans
X axis is time	X axis is frequency
There is no auto-RBW selection unless the EMC Standard is CISPR or MIL	RBW coupled to Span when RBW in auto
There is no auto sweep time	Sweep time coupled to RBW when sweep time in auto
Interval Power calculated in Mkr Function	Band Power calculated in Mkr Function
Can only define time limits when in zero span	Can only define frequency limits when in swept SA
Marker Count counts at the center frequency	Marker Count counts at the marker frequency
CF Step Size set to RBW value	CF Step autocouples to 10% of Span
Some “Marker ->” commands not available.	Other “Marker ->” commands not available
Freq entry mode always Center/Span	Freq entry mode can be Center/Span or Start/Stop
N dB points reports a time difference.	N dB points reports a frequency difference.

Key Path	Span X Scale
Example	FREQ:SPAN 0 Hz sets the span to zero, switches to Zero Span Sending FREQ:SPAN 1 MHz while in Zero Span, switches to Swept span
Notes	Setting the Span to 0 Hz will change to Zero Span and setting the span to a non-zero value will select a swept span
Notes	n /a
Dependencies	Zero Span key is unavailable (grayed out) if the following is true: Frequency scale type is LOG (for example, Log Sweep is On)

Couplings	Pressing Zero Span key (switching to Zero Span): Turns off signal track function (span zoom). Turns off the auto-coupling of RBW and sweep time.
Initial S/W Revision	Prior to A.02.00

Last Span

Changes the displayed frequency span to the previous span setting. If it is pressed immediately after Signal Track is turned off, then the span setting returns to the span that was in effect before Signal Track was turned on.

If this key is pressed while in a nonzero span, and the previous value of span was 0, it will put the analyzer back in Zero Span. And if it is pressed while in zero span, it will set the analyzer back to its last nonzero span.

Pressing Last Span places the analyzer in Center/Span frequency entry mode.

Key Path	Span X Scale
Remote Command	[:SENSE] :FREQuency:SPAN:PREVious
Example	FREQ:SPAN:PREV sets the span to the previous value
Notes	n /a
Initial S/W Revision	Prior to A.02.00

Signal Track (Span Zoom)

When Marker 1 is placed on a signal and Signal Track is pressed, the marker remains on the signal while the analyzer retunes the center frequency to the marker frequency. The analyzer keeps the signal at the center of the display, as long as the amplitude of the signal does not change by more than +/-3 dB from one sweep to another. If Marker 1 is not in Normal or Delta, turning on Signal Track sets it to Normal, perform a peak search, and center the marker on the display.

See [“More Information” on page 1178](#).

Key Path	SPAN X Scale
Remote Command	:CALCulate:MARKer:TRCKing[:STATE] OFF ON 0 1 :CALCulate:MARKer:TRCKing[:STATE] ?
Example	CALC:MARK:TRCK ON turns on Signal Track using Marker 1. CALC:MARK:TRCK ?

Span X-Scale

Dependencies	<p>Signal Track is associated with Marker 1. When marker 1 is turned off or set to Fixed, signal track is turned off as well.</p> <p>Signal Track is not available (grayed out) when Source Mode=Tracking.</p> <p>Signal Track and Continuous Pk cannot be used with each other. If one is on, the other is grayed out. .</p> <p>Signal Track is grayed out if in Zero Span.</p> <p>But if Zero Span is entered while in Signal Track, Signal Track is turned off.</p> <p>Signal Track can only function properly if the trace Marker 1 is on is updating. Therefore if Signal Track is on and the trace Marker 1 is on is put into View, Signal Track is turned off and the Signal Track key grayed out. Whenever the trace Marker 1 is on is not updating, the Signal Track key is grayed out.</p> <p>Signal Track is only available in SA measurement . It should be grayed out in other Measurements in the Spectrum Analyzer mode.</p>
Couplings	<p>Signal Track can only function properly if the trace Marker 1 is on, is in Trace Update = Active. Therefore if the trace Marker 1 is on is in Update Off when Signal Track is turned on, it is changed to Update On. If the trace Marker 1 is on is set to Update Off while Signal Track is on, it turns off Signal Track.</p>
Preset	OFF
State Saved	Saved in instrument state
Status Bits/OPC dependencies	<p>Overlapped until target span is achieved. The Measuring bit remains set until all signal track actions are complete (any reacquisition or zooming required). See details above this table.</p>
Initial S/W Revision	Prior to A.02.00

More Information

If marker 1 is off when Signal Track is turned on, marker 1 is turned on in the center of the screen and a peak search is performed. If marker 1 is already on, it stays on and is used where it is. If it is Fixed, it is set to Normal.

If you move the marker during Signal Track, a Mkr-> CF is performed and the signal track function starts over.

If the signal is lost, an attempt will be made to find it again and continue tracking. If there are other signals on screen that are near the same amplitude, one of them may be found instead since the algorithm is seeking a signal with amplitude similar to the amplitude of the original signal.

Signals near 0 Hz cannot be tracked effectively as they cannot be distinguished from the LO feed-through, which is excluded by intent from the search algorithm.

As a speed optimization, the center frequency is only changed if it differs from the marker position by 1% or more of the span.

If the analyzer is in Single Sweep and Signal Track is turned on, then nothing happens until a sweep is actually initiated (i.e. by an INIT:IMM or Single keypress, and a trigger). Once the sweep is initiated, the entire set of sweeps necessary to complete a pass through the signal track algorithm ensues before the analyzer returns *OPC true, returns results to a READ or MEASure, or returns to the idle state.

If the span is changed while in Signal Track, either by you or because moving the instrument to the signal's frequency results in Span Limiting (as described under the Frequency key), an "auto-zoom" algorithm is executed to get to the new span without losing the signal. In "auto zoom", the span is reduced in stages, with a sweep between each stage. You will see this zooming occur as each sweep is performed, and the new span is set.

When auto-zooming, the set of steps necessary to achieve the target span is to be considered a "measurement," thus the entire process executes even if the analyzer is in single sweep. *OPC will not return true until the process is complete nor will results be returned to a READ or MEASure command. Note further that if the analyzer is in a measurement such as averaging when this happens, the act of changing the span restarts averaging but the first average trace is the last trace of the auto zoom.

When you increase the span, we go directly to the new span. No zooming is required.

This function is intended to track signals with a frequency that is changing (drifting), and an amplitude that is not changing. It keeps tracking if you are in continuous-sweep mode. If in single-sweep mode, as described above, the analyzer only does one center frequency adjustment as necessary.

Span X-Scale

Sweep/Control

Accesses a menu that enables you to configure the Sweep and Control functions of the analyzer, such as Sweep Time and Gating.

Key Path	Front-panel key
Initial S/W Revision	Prior to A.02.00

Sweep Time

Controls the time the analyzer takes to sweep the current frequency span when the Sweep Type is Swept, and displays the equivalent Sweep Time when the Sweep Type is FFT.

When Sweep Time is in Auto, the analyzer computes a sweep time which will give accurate measurements based on other settings of the analyzer, such as RBW and VBW.

NOTE

The Meas Uncal (measurement uncalibrated) warning is given in the Status Bar in the lower right corner of the screen when the manual sweep time entered is faster than the sweep time computed by the analyzer's sweep time equations, that is, the Auto Sweep Time. The analyzer's computed sweep time will give accurate measurements; if you sweep faster than this your measurements may be inaccurate. A Meas Uncal condition may be corrected by returning the Sweep Time to Auto; by entering a longer Sweep Time; or by choosing a wider RBW and/or VBW

On occasion other factors such as the YTF sweep rate (in high band) or the LO's capability (in low band) can cause a Meas Uncal condition. The most reliable way to correct it is to return the Sweep Time to Auto.

When Sweep Type is FFT, you cannot control the sweep time, it is simply reported by the analyzer to give you an idea of how long the measurement is taking.

Note that although some overhead time is required by the analyzer to complete a sweep cycle, the sweep time reported when Sweep Type is Swept does not include the overhead time, just the time to sweep the LO over the current Span. When Sweep Type is FFT, however, the reported Sweep Time takes into account both the data acquisition time and the processing time, in order to report an equivalent Sweep Time for a meaningful comparison to the Swept case.

Because there is no "Auto Sweep Time" when in zero span, the Auto/Man line on this key disappears when in Zero Span. The Auto/Man line also disappears when in an FFT sweep. In this case the key is grayed out as shown below.



Key Path	Sweep/Control
----------	---------------

Sweep/Control

Remote Command	<pre>[:SENSE] :SWEep:TIME <time> [:SENSE] :SWEep:TIME? [:SENSE] :SWEep:TIME:AUTO OFF ON 0 1 [:SENSE] :SWEep:TIME:AUTO?</pre>
Example	<pre>SWE:TIME 500 ms SWE:TIME:AUTO OFF</pre>
Notes	<p>The values shown in this table reflect the “swept spans” conditions which are the default settings after a preset. See “Couplings” for values in the zero span domain.</p>
Dependencies	<p>The third line of the softkey (Auto/Man) disappears in Zero Span. The SCPI command SWEep:TIME:AUTO ON if sent in Zero Span generates an error message.</p> <p>Softkey grayed out and third line of the softkey (Auto/Man) disappears in FFT sweeps. Pressing the key or sending the SCPI for sweep time while the instrument is in FFT sweep generates a –221, “Settings Conflict;” error. The SCPI command :SWEep:TIME:AUTO ON if sent in FFT sweeps generates an error.</p> <p>Grayed out while in Gate View, to avoid confusing those who want to set Gate View Sweep Time.</p> <p>Key is grayed out in Measurements that do not support swept mode.</p> <p>Key is blanked in Modes that do not support swept mode.</p> <p>Set to Auto when Auto Couple is pressed or sent remotely</p>
Couplings	<p>Sweep Time is coupled primarily to Span and RBW. Center Frequency, VBW, and the number of sweep points also can have an effect. So changing these parameters may change the sweep time.</p> <p>The Sweep Time used upon entry to Zero Span is the same as the Sweep Time that was in effect before entering Zero Span. The Sweep Time can be changed while in Zero Span. Upon leaving Zero Span, the Auto/Man state of Sweep Time that existed before entering Zero Span is restored.</p> <p>If Sweep Time was in Auto before entering Zero Span, or if it is set to Auto while in zero span (which can happen via remote command or if Auto Couple is pressed) it returns to Auto and recouples when returning to non-zero spans.</p> <p>If Sweep Time was in Man before entering Zero Span, it returns to Man when returning to non-zero spans, and any changes to Sweep Time that were made while in Zero Span are retained in the non-zero span (except where constrained by minimum limits, which are different in and out of zero span).</p>
Preset	<p>The preset Sweep Time value is hardware dependent since Sweep Time presets to “Auto”.</p>
State Saved	<p>Saved in instrument state</p>
Min	<p>in zero span: 1 μs in swept spans: 1 ms</p>

Max	in zero span: 6000 s in swept spans: 4000 s
Status Bits/OPC dependencies	Meas Uncal is Bit 0 in the STATus:QUEStionable:INTegrity:UNCalibrated register
Initial S/W Revision	Prior to A.02.00

Sweep Setup

Lets you set the sweep functions that control features such as sweep type and time.

Key Path	Sweep/Control
Dependencies	The whole Sweep Setup menu is grayed out in Zero Span, however, the settings in the menus under Sweep Setup can be changed remotely with no error indication. Grayed out in measurements that do not support swept mode. Blanked in modes that do not support swept mode
Initial S/W Revision	Prior to A.02.00

Sweep Time Rules

Allows the choice of three distinct sets of sweep time rules. These are the rules that are used to set the sweep time when **Sweep Time** is in **Auto mode**. Note that these rules only apply when in the Swept **Sweep Type** (either manually or automatically chosen) and not when in FFT sweeps.

See [“More Information” on page 1184](#).

Key Path	Sweep/Control, Sweep Setup
Remote Command	[:SENSe] :SWEep:TIME:AUTO:RULEs NORMal ACCuracy SREsponse [:SENSe] :SWEep:TIME:AUTO:RULEs?
Example	SWE:TIME:AUTO:RUL ACC
Dependencies	In Zero Span, this key is irrelevant and cannot be accessed (because the whole Sweep Setup menu is grayed out in Zero Span), however its settings can be changed remotely with no error indication. Grayed out in FFT sweeps. Pressing the key while the instrument is in FFT sweep generates an advisory message. The SCPI is acted upon if sent, but has no effect other than to change the readout on the key, as long as the analyzer is in an FFT sweep.
Couplings	Set to Auto on Auto Couple
Preset	AUTO
State Saved	Saved in instrument state

Sweep/Control

Backwards Compatibility SCPI	<p>The old Auto Sweep Time command was the same [:SENSe]:SWEep:TIME:AUTO:RULEs NORMAl ACCuracy so it still works although it now has a third parameter (SRESponse).</p> <p>The old Sweep Coupling command was [:SENSe]:SWEep:TIME:AUTO:MODE SRESponse SANalyzer and it is aliased as follows:</p> <p>:SWEep:TIME:AUTO:MODE SRESponse is aliased to :SWEep:TIME:AUTO:RULEs SRESponse, and :SWEep:TIME:AUTO:MODE SANalyzer is aliased to :SWEep:TIME:AUTO:RULEs NORMAl</p> <p>The query:SWEep:TIME:AUTO:MODE? is aliased to :SWEep:TIME:RULEs?</p> <p>So it will fail to match for SANalyzer</p>
Initial S/W Revision	Prior to A.02.00

More Information

The first set of rules is called **SA – Normal. Sweep Time Rules** is set to **SA-Normal** on a **Preset** or **Auto Couple**. These rules give optimal sweep times at a loss of accuracy. Note that this means that in the Preset or Auto Coupled state, instrument amplitude accuracy specifications do not apply.

Setting **Sweep Time Rules** to **SA-Accuracy** will result in slower sweep times than **SA-Normal**, usually about three times as long, but with better amplitude accuracy for CW signals. The instrument absolute amplitude accuracy specifications only apply when **Sweep Time** is set to **Auto**, and **Sweep Time Rules** are set to **SA-Accuracy**. Additional amplitude errors which occur when **Sweep Time Rules** are set to **SA-Normal** are usually well under 0.1 dB, though this is not guaranteed. Because of the faster sweep times and still low errors, **SA-Normal** is the preferred setting of **Sweep Time Rules**.

The third set of sweep time rules is called **Stimulus/Response** and is automatically selected when an integrated source is turned on, such as a Tracking Generator or a synchronized external source. The sweep times for this set of rules are usually much faster for swept-response measurements. Stimulus-response auto-coupled sweep times are typically valid in stimulus-response measurements when the system's frequency span is less than 20 times the bandwidth of the device under test. You can select these rules manually (even if not making Stimulus-Response measurements) to get faster sweeps without the "Meas Uncal" warning, but you are then not protected from the over-sweep condition and may end up with uncalibrated results. However, it is commonplace in measuring non-CW signals such as noise to be able to get excellent measurement accuracy at sweep rates higher than those required for CW signal accuracy, so this is a valid measurement technique.

Auto

Sets the analyzer to automatically choose the Sweep Time Rules for the measurement.

Key Path	Sweep/Control, Sweep Setup, Sweep Time Rules
----------	---

Remote Command	[:SENSE] :SWEep:TIME:AUTO:RULEs:AUTO[:STATe] ON OFF 1 0 [:SENSe] :SWEep:TIME:AUTO:RULEs:AUTO[:STATe] ?
Example	:SWE:TIME:AUTO:RUL:AUTO ON
Couplings	Set on Preset or Auto Couple
Preset	ON
Initial S/W Revision	Prior to A.02.00

SA - Normal

Chooses Sweep Time Auto Rules for optimal speed and generally sufficient accuracy.

Key Path	Sweep/Control, Sweep Setup, Sweep Time Rules
Example	:SWE:TIME:AUTO:RUL NORM
Couplings	Automatically selected unless Source is on If directly selected, sets AUTO to Off
Readback	SA - Normal
Initial S/W Revision	Prior to A.02.00

SA - Accuracy

Chooses Sweep Time Auto Rules for specified absolute amplitude accuracy.

Key Path	Sweep/Control, Sweep Setup, Sweep Time Rules
Example	:SWE:TIME:AUTO:RUL ACC
Dependencies	Do not allow sweep time to fall below 20 ms when in SA - Accuracy
Couplings	If directly selected, sets AUTO to Off
Readback	SA - Accuracy
Initial S/W Revision	Prior to A.02.00

Stimulus/Response

The Stimulus-Response setting for sweep time rules provides different sweep time settings, for the case where the analyzer is sweeping in concert with a source. These modified rules take two forms:

1. Sweeping along with a swept source, which allows faster sweeps than the normal case because the RBW and VBW filters do not directly interact with the Span. We call this “Swept Tracking”
2. Sweeping along with a stepped source, which usually slows the sweep down because it is necessary to wait for the stepped source and the analyzer to settle at each point. We call this “Stepped Tracking”

The analyzer chooses one of these methods based on what kind of a source is connected or installed; it picks Swept Tracking if there is no source in use.

Sweep/Control

As always, when the X-series analyzer is in Auto Sweep Time, the sweep time is estimated and displayed in the Sweep/Control menu as well as in the annotation at the bottom of the displayed measurement; of course, since this can be dependent on variables outside the analyzer's control, the actual sweep time may vary slightly from this estimate.

You can always choose a shorter sweep time to improve the measurement throughput, (with some potential unspecified accuracy reduction), but the Meas Uncal indicator will come on if the sweep time you set is less than the calculated Auto Sweep time. You can also select a longer sweep time, which can be useful (for example) for obtaining accurate insertion loss measurements on very narrowband filters. The number of measurement points can also be reduced to speed the measurement (at the expense of frequency resolution).

Key Path	Sweep/Control, Sweep Setup, Sweep Time Rules
Example	:SWE:TIME:AUTO:RUL SRES
Couplings	Automatically selected when the Source is on (Source Mode not set to OFF). If directly selected sets AUTO to Off
Readback	SR
Initial S/W Revision	Prior to A.02.00

Sweep Type

Chooses between the FFT and Sweep types of sweep.

Sweep Type refers to whether or not the instrument is in Swept or FFT analysis. When in Auto, the selection of sweep type is governed by two different sets of rules, depending on whether you want to optimize for dynamic range or for speed.

FFT "sweeps" should not be used when making EMI measurements; therefore, when a CISPR detector (Quasi Peak, EMI Average, RMS Average) is selected for any active trace (one for which Update is on), the FFT key in the Sweep Type menu is grayed out, and the Auto Rules only choose Swept. If Sweep Type is manually selected to be FFT, the CISPR detectors are all grayed out.

FFT sweeps will never be auto-selected when Screen Video, Log Video or Linear Video are the selected Analog Output.

Key Path	Sweep/Control, Sweep Setup
Remote Command	[:SENSe] :SWEep:TYPE FFT SWEep [:SENSe] :SWEep:TYPE?
Notes	For a backward compatibility, the following remote parameters AUTO SWP will be supported by the [:SENSe]:SWEep:TYPE command.

Dependencies	In Zero Span, this key is irrelevant and cannot be accessed (because the whole Sweep Setup menu is grayed out in Zero Span), however its settings can be changed remotely with no error indication. When Gate is on, Gate Method selection affects Sweep Type: Method FFT&Sweep menu FFT - Swept grayed out and rules choose FFT Video - FFT grayed out and rules choose Swept LO - FFT grayed out and rules choose Swept
Preset	AUTO
Backwards Compatibility SCPI	[:SENSe] :SWEep :TYPE AUTO !sets sweep type Auto to On [:SENSe] :SWEep :TYPE SWP !selects sweep type Swept
Initial S/W Revision	Prior to A.02.00

Auto

When in Auto, the selection of sweep type is governed by two different sets of rules, depending on whether you want to optimize for dynamic range or for speed. These rules are chosen under the **Sweep Type Rules** key.

Key Path	Sweep/Control, Sweep Setup, Sweep Type
Remote Command	[:SENSe] :SWEep :TYPE :AUTO OFF ON 0 1 [:SENSe] :SWEep :TYPE :AUTO?
Example	:SWE:TYPE:AUTO ON
Couplings	Pressing Auto Couple always sets Sweep Type to Auto. Swept is always chosen whenever any form of Signal ID is on, or the Source Mode is set to Tracking, or any EMI detector is selected.
Preset	ON
State Saved	Saved in instrument state
Initial S/W Revision	Prior to A.02.00

Swept

Manually selects swept analysis, so it cannot change automatically to FFT.

Key Path	Sweep/Control, Sweep Setup, Sweep Type
Example	SWE:TYPE SWE
Dependencies	Grayed out while in Gated FFT (meaning Gate is ON and Gate Method is FFT). If this key is selected, the gate method Gated FFT is grayed out.

Sweep/Control

Couplings	This selection is chosen automatically if any of the CISPR detectors is chosen for any active trace, in which case the FFT Sweep Type selection is also grayed out.
State Saved	Saved in instrument state
Readback	Swept
Initial S/W Revision	Prior to A.02.00
Modified at S/W Revision	A.02.00

FFT

Manually selects FFT analysis, so it cannot change automatically to Swept.

Key Path	Sweep/Control, Sweep Setup, Sweep Type
Example	SWE:TYPE FFT
Dependencies	<p>When a CISPR detector (Quasi Peak, EMI Average, RMS Average) is selected for any active trace, the FFT key is grayed out.</p> <p>If Sweep Type is manually selected to be FFT, the CISPR detectors are all grayed out.</p> <p>If this key is selected, all of the gate Methods except Gated FFT are grayed out.</p> <p>If Manual FFT is selected, the Tracking Source Mode key is grayed out.</p> <p>When Source Mode is set to Tracking, Manual FFT is grayed out.</p> <p>If Manual FFT is selected, the Signal ID key is grayed out.</p> <p>When Signal ID is on, Manual FFT is grayed out.</p> <p>Grayed out while in Gated LO (meaning Gate is ON and Gate Method is LO).</p> <p>Grayed out while in Gated Video (meaning Gate is ON and Gate Method is Video).</p>
State Saved	Saved in instrument state
Readback	FFT
Initial S/W Revision	Prior to A.02.00

Sweep Type Rules

Selects which set of rules will be used for automatically choosing the Sweep Type when Sweep Type is in Auto.

Key Path	Sweep/Control, Sweep Setup
Remote Command	<pre>[:SENSE] :SWEep:TYPE:AUTO:RULEs SPEed DRANGE [:SENSE] :SWEep:TYPE:AUTO:RULEs?</pre>

Dependencies	In Zero Span, this key is irrelevant and cannot be accessed (because the whole Sweep Setup menu is grayed out in Zero Span), however its settings can be changed remotely with no error indication.
Preset	DRANge
State Saved	Saved in instrument state
Initial S/W Revision	Prior to A.02.00

Auto

This selection is automatically chosen when Auto Couple is pressed. When in Auto, the Sweep Type Rules are set to Best Dynamic Range. It seems like a very simple Auto function but the use of this construct allows a consistent statement about what the Auto Couple key does.

Key Path	Sweep/Control, Sweep Setup, Sweep Type Rules
Remote Command	[:SENSE] :SWEep:TYPE:AUTO:RULEs:AUTO[:STATE] OFF ON 0 1 [:SENSE] :SWEep:TYPE:AUTO:RULEs:AUTO[:STATE] ?
Example	:SWE:TYPE:AUTO:RUL:AUTO ON
Couplings	Pressing Auto Couple always sets Sweep Type Rules to Auto.
Preset	ON
State Saved	Saved in instrument state
Initial S/W Revision	Prior to A.02.00

Best Dynamic Range

This selection tells the analyzer to choose between swept and FFT analysis with the primary goal of optimizing dynamic range. If the dynamic range is very close between swept and FFT, then it chooses the faster one. This auto selection also depends on RBW Type.

In determining the Swept or FFT setting, the auto rules use the following approach:

- If the RBW Filter Type is Gaussian use the RBW for the Normal Filter BW and if that RBW > 210 Hz, use swept; for RBW <= 210 Hz, use FFT
- If the RBW Filter Type is Flat Top, use the same algorithm but use 420 Hz instead of 210 Hz for the transition point between Swept and FFT
- If any of the CISPR detectors is chosen for any active trace, always use Swept.

Key Path	Sweep/Control, Sweep Setup, Sweep Type Rules
Example	SWE:TYPE:AUTO:RUL DRAN sets the auto rules to dynamic range.
Couplings	Directly selecting this setting sets AUTO to OFF.
Readback	Dynamic Range
Initial S/W Revision	Prior to A.02.00

Sweep/Control

Best Speed

This selection tells the analyzer to choose between FFT or swept analysis based on the fastest analyzer speed.

Key Path	Sweep/Control, Sweep Setup, Sweep Type Rules
Example	SWE:TYPE:AUTO:RUL SPE sets the rules for the auto mode to speed
Couplings	Directly selecting this setting sets AUTO to OFF.
Readback	Speed.
Initial S/W Revision	Prior to A.02.00

FFT Width

This menu displays and controls the width of the FFT's performed while in FFT mode. The "FFT width" is the range of frequencies being looked at by the FFT, sometimes referred to as the "chunk width" -- it is not the resolution bandwidth used when performing the FFT.

It is important to understand that this function does not directly set the FFT width, it sets the limit on the FFT Width. The actual FFT width used is determined by several other factors including the Span you have set. Usually the instrument picks the optimal FFT Width based on the current setup; but on occasion you may wish to limit the FFT Width to be narrower than that which the instrument would have set.

NOTE This function does not allow you to widen the FFT Width beyond that which the instrument might have set; it only allows you to narrow it. You might do this to improve the dynamic range of the measurement or eliminate nearby spurs from your measurement.

Note that the **FFT Width** setting will have no effect unless in an FFT sweep.

See "[More Information](#)" on page 1192

Key Path	Sweep/Control, Sweep Setup
Remote Command	[:SENSE] :SWEep:FFT:WIDTh <real> [:SENSE] :SWEep:FFT:WIDTh?
Example	SWE:FFT:WIDTh 167 kHz sets this function to "<167.4 kHz>"
Notes	The parameter is in units of frequency. For values sent from SCPI, the analyzer chooses the smallest value that is at least as great as the requested value. Examples: Parameter 3.99 kHz is sent over SCPI. Analyzer chooses 4.01 kHz Parameter 4.02 kHz is sent over SCPI. Analyzer chooses 28.81 kHz Parameter 8 MHz is sent over SCPI. Analyzer chooses 10 MHz

Dependencies	<p>In some models, the analog prefilters are not provided. In these models the FFT Width function is always in Auto. The FFT Width key is blanked in these models, and the SCPI commands are accepted without error but have no effect.</p> <p>In Zero Span, this key is irrelevant and cannot be accessed (because the whole Sweep Setup menu is grayed out in Zero Span). However, its settings can be changed remotely with no error indication.</p>
Couplings	The FFT Width affects the ADC Dither function (see Meas Setup key) and the point at which the instrument switches from Swept to FFT acquisition.
Preset	The Preset is Auto, but Preset will also pick Best Dynamic Range and hence this function will be set to ~Maximum
State Saved	Saved in instrument state
Min	4.01 kHz
Max	<p>The maximum available FFT width is dependent on the IF Bandwidth option. The maximum available width is:</p> <p>Option B10, 10 MHz;</p> <p>Option B25, 25 MHz,</p> <p>Option B40, 40 MHz.</p>
Backwards Compatibility SCPI	<p><code>[:SENSe]:SWEep:FFT:SPAN:RATio <integer></code></p> <p><code>[:SENSe]:SWEep:FFT:SPAN:RATio?</code></p> <p>The behavior of the analyzer when it receives this command is to compute the “intended segment width” by dividing the Span by the FFTs/Span parameter, then converting this intended width to an actual width by using the largest available FFT Width that is still less than the intended segment width. The “Span” used in this computation is whatever the Span is currently set to, whether a sweep has been taken at that Span or not.</p>
Initial S/W Revision	Prior to A.02.00
Modified at S/W Revision	A.04.00

Key Path	Sweep/Control, Sweep Setup
Remote Command	<p><code>[:SENSe] :SWEep:FFT:WIDTh:AUTO OFF ON 0 1</code></p> <p><code>[:SENSe] :SWEep:FFT:WIDTh:AUTO?</code></p>
Example	<code>:SWE:FFT:WIDT:AUTO ON</code>
Couplings	Pressing Auto Couple always sets FFT Width to Auto.
Preset	ON
State Saved	Saved in instrument state
Initial S/W Revision	Prior to A.02.00

More Information

An FFT measurement can only be performed over a limited span known as the “FFT segment”. Several segments may need to be combined to measure the entire span. For advanced FFT control in the X-Series, you have direct control over the segment width using the **FFT Width** control. Generally, in automatic operation, the X-Series sets the segment width to be as wide as possible, as this results in the fastest measurements.

However, in order to increase dynamic range, most X-series models provide a set of analog prefilters that precede the ADC. Unlike swept measurements, which pass the signal through a bandpass before the ADC, FFT measurements present the full signal bandwidth to the ADC, making them more susceptible to overload, and requiring a lower signal level. The prefilters act to alleviate this phenomenon - they allow the signal level at the ADC to be higher while still avoiding an ADC overload, by eliminating signal power outside the bandwidth of interest, which in turn improves dynamic range.

Although narrowing the segment width can allow higher dynamic ranges some cases, this comes at the expense of losing some of the speed advantages of the FFT, because narrower segments require more acquisitions and proportionately more processing overhead.

However, the advantages of narrow segments can be significant. For example, in pulsed-RF measurements such as radar, it is often possible to make high dynamic range measurements with signal levels approaching the compression threshold of the analyzer in swept spans (well over 0 dBm), while resolving the spectral components to levels below the maximum IF drive level (about -8 dBm at the input mixer). But FFT processing experiences overloads at the maximum IF drive level even if the RBW is small enough that no single spectral component exceeds the maximum IF drive level. If you reduce the width of an FFT, an analog filter is placed before the ADC that is about 1.3 times as wide as the FFT segment width. This spreads out the pulsed RF in time and reduces the maximum signal level seen by the ADC. Therefore, the input attenuation can be reduced and the dynamic range increased without overloading the ADC.

Further improvement in dynamic range is possible by changing the **FFT IF Gain** (in the **Meas Setup** menu of many measurements). If the segments are reduced in width, **FFT IF Gain** can be set to High, improving dynamic range.

Depending on what IF Bandwidth option you have ordered, there can be up to three different IF paths available in FFT sweeps, as seen in the diagram below:

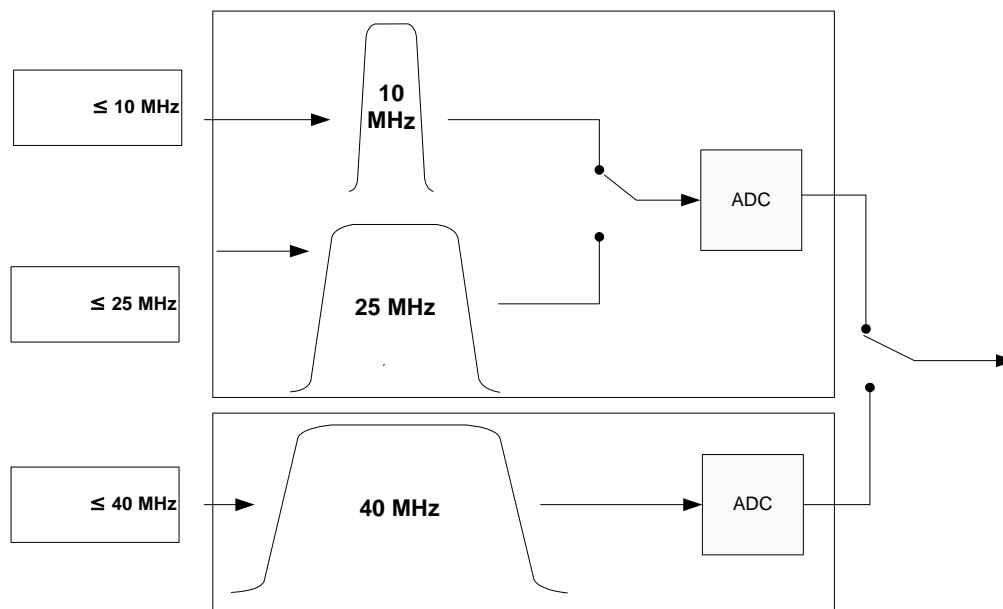

The 10 MHz path is always used for Swept sweeps. It is always used for FFT sweeps as well, unless the user specifies ~25 MHz in which case the 25 MHz path will be used for FFT sweeps, or ~40 MHz, in which case the 40 MHz path will be used for FFT sweeps. Note that, although each of these keys picks the specified path, the analyzer may choose an FFT width less than the full IF width, in order to optimize speed, trading off acquisition time versus processing time.

Pause/Resume

Pauses a measurement after the current data acquisition is complete.

When Paused, the label on the key changes to Resume. Pressing Resume un-pauses the measurement.

When you are Paused, pressing **Restart**, **Single** or **Cont** does a Resume.

Key Path	Sweep/Control
Remote Command	:INITiate:PAUSE
Dependencies	Grayed out in Measurements that do not support Pausing. Blanked in Modes that do not support Pausing.
Initial S/W Revision	Prior to A.02.00

Key Path	Sweep/Control
Remote Command	:INITiate:RESume
Dependencies	Grayed out in Measurements that do not support Pausing. Blanked in Modes that do not support Pausing.
Initial S/W Revision	Prior to A.02.00

Sweep/Control

Gate

Accesses a menu that enables you to control the gating function. The Gate functionality is used to view signals best viewed by qualifying them with other events.

Gate setup parameters are the same for all measurements – they do not change as you change measurements. Settings like these are called “Meas Global” and are unaffected by Meas Preset.

Note that Sweep Time autocoupling rules and annotation are changed by Gate being on.

Key Path	Sweep/Control
Scope	Meas Global
Readback	The state and method of Gate, as [Off, LO] or [On, Video]. Note that for measurements that only support gated LO, the method is nonetheless read back, but always as LO.
Initial S/W Revision	Prior to A.02.00

Gate On/Off

Turns the gate function on and off.

When the Gate Function is on, the selected Gate Method is used along with the gate settings and the signal at the gate source to control the sweep and video system with the gate signal. Not all measurements allow every type of Gate Methods.

When Gate is on, the annunciation in the measurement bar reflects that it is on and what method is used, as seen in the following "Gate: LO" annunciator graphic.

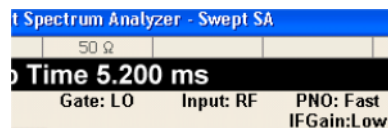

Key Path	Sweep/Control, Gate
Remote Command	[:SENSe] :SWEep:EGATe [:STATe] OFF ON 0 1 [:SENSe] :SWEep:EGATe [:STATe] ?
Example	SWE:EGAT ON SWE:EGAT?

Dependencies	<p>The function is unavailable (grayed out) and Off when:</p> <ul style="list-style-type: none"> • Gate Method is LO or Video and FFT Sweep Type is manually selected. • Gate Method is FFT and Swept Sweep Type is manually selected. • Marker Count is ON. <p>The following are unavailable whenever Gate is on:</p> <ul style="list-style-type: none"> • FFT under Sweep Type when Method=LO or Video or Swept under Sweep Type when Method=FFT • Marker Count <p>While Gate is on, the Auto Rules for Sweep Type are modified so that the choice agrees with the Gate Method: i.e., FFT for Method = FFT and Swept for Method = LO or Video.</p> <p>The Gate softkey and all SCPI under the [:SENSe]:SWEep:EGATe SCPI node are grayed out when Source Mode is Tracking with an external source. This is because the Gate circuitry is used to sync the external source. If the Tracking Source is turned on, the Gate is turned off.</p>
Couplings	<p>When Meas Method is RBW or FAST, this function is unavailable and the key is grayed out.</p> <p>Whenever Gate is on, Meas Method, RBW or FAST is unavailable and keys for those are grayed out.</p> <p>When Gate is on, Offset Res BW and Offset Video BW are ignored (if you set these values) and the measurement works as if all Offset Res BW and all Offset Video BW are coupled with the Res BW and the Video BW under the BW menu. When Gate is on, the Offset BW key in the Offset/Limit menu is grayed out.</p>
Preset	Off
State Saved	Saved in instrument state
Range	On Off
Backwards Compatibility SCPI	[:SENSe]:SWEep:TIME:GATE[:STATe]
Initial S/W Revision	Prior to A.02.00

Gate View On/Off

Turning on Gate View in the Swept SA measurement provides a single-window gate view display.

Turning on Gate View in other measurements shows the split-screen Gate View. In these measurements, when the Gate View is on, the regular view of the current measurement traces and results are reduced vertically to about 70% of the regular height. The Zero Span window, showing the positions of the Gate, is shown between the Measurement Bar and the reduced measurement window. By reducing the height of the measurement window, some of the annotation on the Data Display may not fit and is not shown.

Key Path	Sweep/Control, Gate
----------	----------------------------

Sweep/Control

Remote Command	[:SENSe] :SWEep:EGATe:VIEW ON OFF 1 0 [:SENSe] :SWEep:EGATe:VIEW?
Example	SWE:EGAT:VIEW ON turns on the gate view.
Dependencies	In the Swept SA measurement: In Gate View, the regular Sweep Time key is grayed out. In the other measurements: When you turn Gate View on, the lower window takes on the current state of the instrument. Upon leaving Gate View, the instrument takes on the state of the lower window. When you turn Gate View on, the upper window Sweep Time is set to the gate view sweep time.
Couplings	These couplings apply to the Swept SA measurement: <ul style="list-style-type: none"> • When Gate View is turned on, the instrument is set to Zero Span. • Gate View automatically turns off whenever a Span other than Zero is selected. • Gate View automatically turns off if you press the Last Span key while in Gate View, and the instrument returns to the Span it was in before entering Gate View (even if that is Zero Span). When Gate View is turned on, the sweep time used is the gate view sweep time. This is set according to the rules in “Gate View Sweep Time” on page 1198 . <ul style="list-style-type: none"> • When Gate View is turned off, Sweep Time is set to the normal Swept SA measurement sweep time. • If Gate View is on and Gate is off, then turning on Gate turns off Gate View.
Preset	OFF
State Saved	Saved in instrument state
Range	On Off
Initial S/W Revision	Prior to A.02.00

A sample of the Gate View screen in the Swept SA measurement is shown in the following graphic:

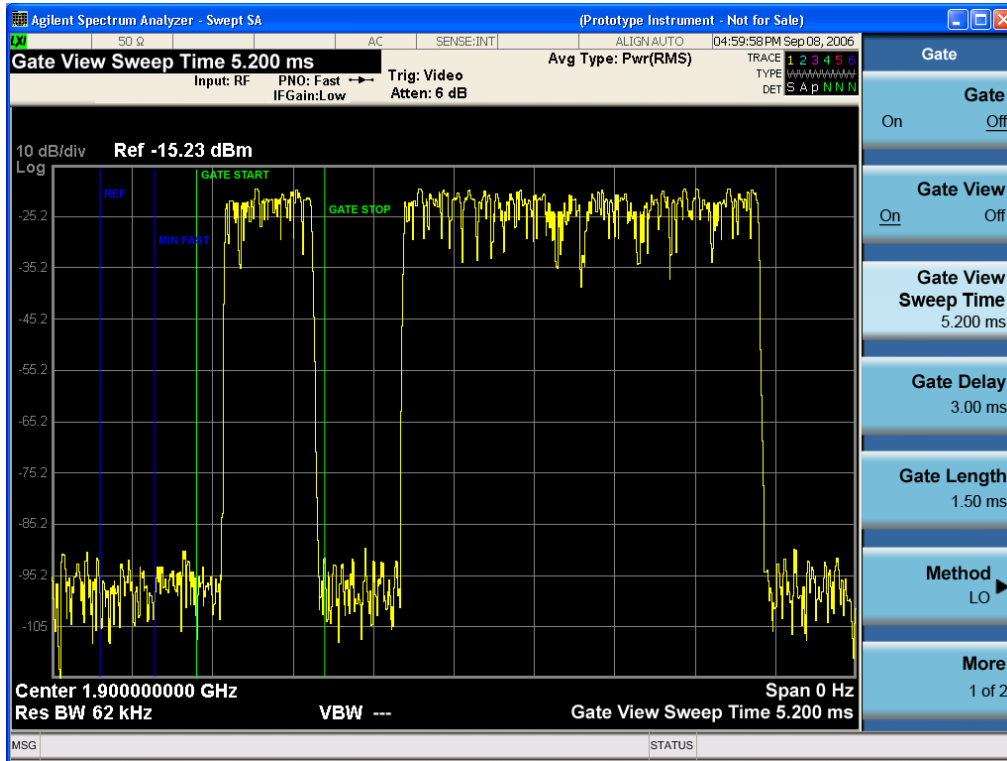

A sample of the Gate View screen in other measurements is shown in the following graphic. This example is for the ACP measurement:

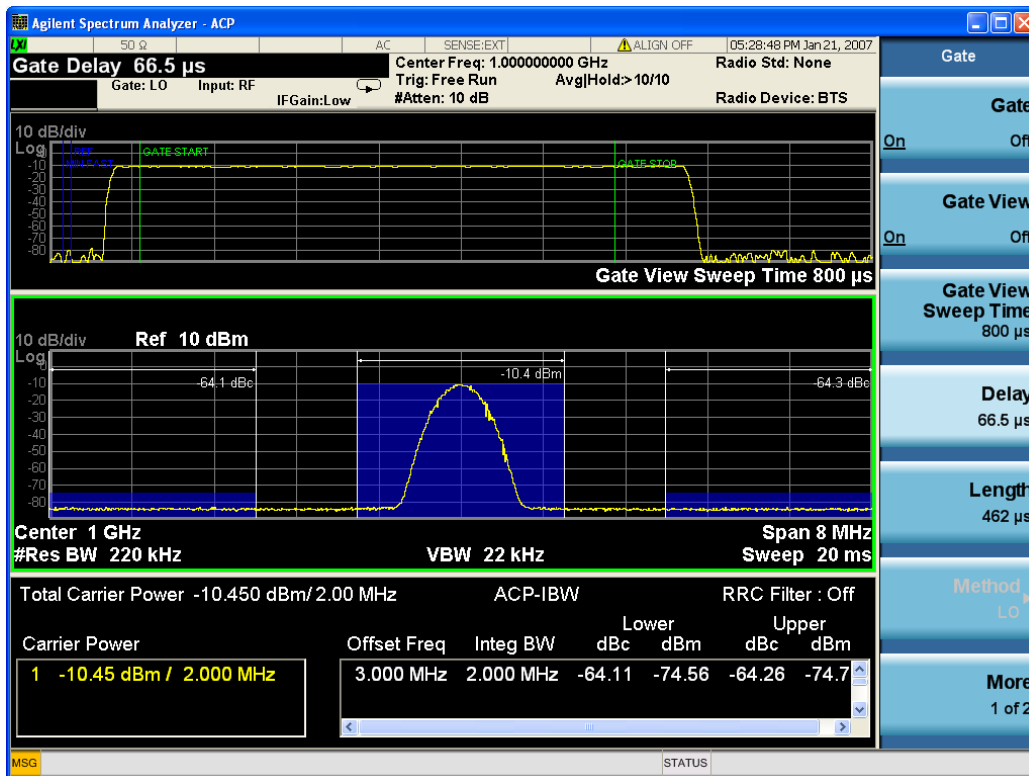

Sweep/Control

Turning Gate View off returns the analyzer to the Normal measurement view.

In the Swept SA, the normal measurement view is the single-window Swept SA view. When returning to this view, the Swept SA measurement returns to the Span it was in before entering **Gate View** (even if that is Zero Span).

The **Gate View** window is triggered from the Gate Source, with zero trigger delay. Also, when updating the **Gate View** window, the Gate itself must not operate. So it is internally shut off while the gate view window is being updated. For the Swept SA measurement, this means that the Gate is internally shut off whenever the gate view window is displayed. The measurement bar and softkeys continue to show the Trigger source for the main sweep window and give no indication that the Gate is shut off or that the Gate View window is triggered from the Gate Source.

When in **Gate View**, vertical lines are displayed in the Gate View window as follows:

- Green lines are displayed at the gate edges as follows: in Edge Gate, a line is shown for Delay and one for the end of the Gate period (defined by Length, even in FFT. In Level Gate a line is shown only for Delay. You can adjust the position of the green lines by adjusting the gate length and the gate delay. These lines update in the Gate View window as the active function changes, even if the window is not being updated. In Gated LO and Gated Video, these lines are positioned relative to the delay reference line (not relative to 0 time). In Gated FFT, their location is relative to the left edge of the screen.
- A blue line is displayed showing the delay reference, that is, the reference point for the Gate Delay within the Zero Span window. The blue line represents where (in time) the effective location of the gate start would be if the gate were programmed to zero delay.
- The second blue line is labeled "MIN FAST" as shown in the figure above because it represents the minimum Gate Delay for fast Gated LO operation. This line is only displayed in Gated LO. You cannot scroll (knob) or decrement (down key) the Gate Delay to less than that represented by the position of this line, it can only be set below this position manually, although once there it can be moved freely with the knob while below the line.
- A yellow line in the Gated Video case only, is displayed at Blength, where Blength is the display point (bucket) length for the swept trace, which is given by the sweep time for that trace divided by number of Points – 1. So it is referenced to 0 time, not to the delay reference. This line is labeled NEXT PT (it is not shown in the figure above because the figure above is for Gated LO). The yellow line represents the edge of a display point (bucket). Normally in Gated Video, the bucket length must be selected so that it exceeds the off time of the burst. There is another way to use the analyzer in Gated Video measurements, and that is to set the bucket width much shorter than the off time of the burst. Then use the Max Hold trace function to fill in "missing" buckets more slowly. This allows you to see some of the patterns of the Gated Video results earlier, though seeing a completely filled-in spectrum later.

Gate View Sweep Time

Controls the sweep time in the Gate View window. To provide an optimal view of the gate signal, the analyzer initializes Gate View Sweep Time based on the current settings of Gate Delay and Gate Length.

Key Path	Sweep/Control, Gate
----------	----------------------------

Remote Command	[:SENSe] :SWEep:EGATe:TIME <time> [:SENSe] :SWEep:EGATe:TIME?
Example	SWE:EGAT:TIME 500 ms
Dependencies	Gate View Sweep Time is initialized: On Preset (after initializing delay and length). Every time the Gate Method is set/changed. Additionally, in the Swept SA measurement, whenever you do a Preset, or leave Gate View, the analyzer remembers the Gate Delay and Gate Length settings. Then, when returning to Gate View, if the current Gate Delay and/or Gate Length do not match the remembered values Gate View Sweep Time is re-initialized. Compute the location of the "gate stop" line, which you know is at time $t = t_{min} + GateDelay + GateLength$.
Preset	519.3 μ s WiMAX OFDMA: 5 ms GSM/EDGE: 1 ms
State Saved	Saved in instrument state
Min	1 μ s
Max	6000 s
Initial S/W Revision	Prior to A.02.00

Gate Delay

Controls the length of time from the time the gate condition goes True until the gate is turned on.

Key Path	Sweep/Control, Gate
Remote Command	[:SENSe] :SWEep:EGATe:DELAy <time> [:SENSe] :SWEep:EGATe:DELAy?
Example	SWE:EGAT:DELAy 500ms SWE:EGAT:DELAy?
Notes	Units of time are required or no units; otherwise an invalid suffix error will be generated. See error -131.
Preset	57.7 us WiMAX OFDMA: 71 us GSM/EDGE: 600 us
State Saved	Saved in instrument state
Min	0.0 us

Sweep/Control

Max	100 s
Backwards Compatibility SCPI	[:SENSe]:SWEep:TIME:GATE:DELay
Initial S/W Revision	Prior to A.02.00

Gate Length

Controls the length of time that the gate is on after it opens.

Key Path	Sweep/Control, Gate
Remote Command	[:SENSe]:SWEep:EGATe:LENGth <time> [:SENSe]:SWEep:EGATe:LENGth?
Example	SWE:EGAT:LENG 1 SWE:EGAT:LENG?
Notes	Units of time are required or no units; otherwise an invalid suffix will be generated.
Dependencies	Grayed out when Gate Method is set to FFT in which case the label changes to that shown below. <div style="border: 1px solid black; padding: 5px; display: inline-block;"> Gate Length (=1.83/RBW) 2.8 ms </div> <small>vsd 39-1</small> The key is also grayed out if Gate Control = Level.
Preset	461.6 us WiMAX OFDMA: 50 us GSM/EDGE: 200 us
State Saved	Saved in instrument state
Min	100 ns
Max	5 s
Backwards Compatibility SCPI	[:SENSe]:SWEep:TIME:GATE:LENGth
Initial S/W Revision	Prior to A.02.00

Method

This lets you choose one of the three different types of gating.

Not all types of gating are available for all measurements.

Key Path	Sweep/Control, Gate
Remote Command	[:SENSe]:SWEep:EGATe:METhod LO VIDeo FFT [:SENSe]:SWEep:EGATe:METhod?

Example	SWE:EGAT:METH FFT
Preset	LO
State Saved	Saved in instrument state
Initial S/W Revision	Prior to A.02.00

LO

When Gate is set to On, the LO sweeps whenever the gate conditions as specified in the Gate menu are satisfied by the signal at the Gate Source.

This form of gating is more sophisticated, and results in faster measurements. With Gated LO, the analyzer only sweeps while the gate conditions are satisfied. This means that a sweep could take place over several gate events. It would start when the gate signal goes true and stop when it goes false, and then continue when it goes true again. But since the LO is sweeping as long as the gate conditions are satisfied, the sweep typically finishes much more quickly than with Gated Video.

When in zero span, there is no actual sweep performed. But data is only taken while the gate conditions are satisfied. So even though there is no sweep, the gate settings will impact when data is acquired.

Key Path	Sweep/Control, Gate, Method
Dependencies	Key is unavailable when Gate is On and FFT Sweep Type manually selected. When selected, Sweep Type is forced to Swept and the FFT key in Sweep Type is grayed out.
Readback	LO
Initial S/W Revision	Prior to A.02.00

Video

When Gate is set to On, the video signal is allowed to pass through whenever the gate conditions as specified in the Gate menu are satisfied by the signal at the Gate Source.

This form of gating may be thought of as a simple switch, which connects the signal to the input of the spectrum analyzer. When the gate conditions are satisfied, the switch is closed, and when the gate conditions are not satisfied, the switch is open. So we only look at the signal while the gate conditions are satisfied.

With this type of gating, you usually set the analyzer to sweep very slowly. In fact, a general rule is to sweep slowly enough that the gate is guaranteed to be closed at least once per data measurement interval (bucket). Then if the peak detector is used, each bucket will represent the peak signal as it looks with the gate closed.

Key Path	Sweep/Control, Gate, Method
Dependencies	Key is unavailable when Gate is On and FFT Sweep Type manually selected. When selected, Sweep Type is forced to Swept and the FFT key in Sweep Type is grayed out
Readback	Video

Sweep/Control

Initial S/W Revision	Prior to A.02.00
----------------------	------------------

FFT

When Gate is set to On, an FFT is performed whenever the gate conditions as specified in the Gate menu are satisfied by the signal at the Gate Source. This is an FFT measurement which begins when the gate conditions are satisfied. Since the time period of an FFT is approximately $1.83/\text{RBW}$, you get a measurement that starts under predefined conditions and takes place over a predefined period. So, in essence, this is a gated measurement. You have limited control over the gate length but it works in FFT sweeps, which the other two methods do not.

Gated FFT cannot be done in zero span since the instrument is not sweeping. So in zero span the Gated LO method is used. Data is still only taken while the gate conditions are satisfied, so the gate settings do impact when data is acquired.

The Gate Length will be $1.83/\text{RBW}$.

This is a convenient way to make a triggered FFT measurement under control of an external gating signal.

Key Path	Sweep/Control, Gate
Dependencies	Key is unavailable when Gate is On and Swept Sweep Type manually selected. Key is unavailable when gate Control is set to Level. When selected, Sweep Type is forced to FFT and the Swept key in Sweep Type is grayed out Forces Gate Length to $1.83/\text{RBW}$
Readback	FFT
Initial S/W Revision	Prior to A.02.00

Gate Source

The menus under the **Gate Source** key follow the same pattern as those under the **Trigger key**, with the exception that neither **Free Run** nor **Video** are available as Gate Source selections. Any changes to the settings in the setup menus under each Gate Source selection key (for example: **Trigger Level**) also affect the settings under the Trigger menu keys. Note that the selected Trigger Source does not have to match the Gate Source.

Key Path	Sweep/Control, Gate
Remote Command	<code>[:SENSe] :SWEep:EGATe:SOURce EXTernal1 EXTernal2 LINE FRAME RFBurst [:SENSe] :SWEep:EGATe:SOURce?</code>
Dependencies	In some models, there is no second External input. In these models, the External 2 key is blanked and the EXTernal2 parameter will generate a "Hardware missing; Not available for this model number" error.

Preset	EXTernal 1 GSM/EDGE: FRAMe
Initial S/W Revision	Prior to A.02.00
Modified at S/W Revision	A.03.00

Control Edge/Level

Sets the method of controlling the gating function from the gating signal.

Edge

In Edge triggering, the gate opens (after the Delay) on the selected edge (for example, positive) of the gate signal and closes on the alternate edge (for example, negative).

Level

In Level triggering, the gate opens (after the Delay) when the gate signal has achieved a certain level and stays open as long as that level is maintained.

Key Path	Sweep/Control, Gate
Remote Command	[:SENSe] :SWEep:EGATe:CONTRol EDGE LEVEl [:SENSe] :SWEep:EGATe:CONTRol?
Example	SWE:EGAT:CONT EDGE
Dependencies	If the Gate Method is FFT the Control key is grayed out and Edge is selected. If the Gate Source is TV, Frame or Line, the Control key is grayed out and Edge is selected.
Preset	EDGE
State Saved	Saved in instrument state
Backwards Compatibility SCPI	[:SENSe]:SWEep:TIME:GATE:TYPE
Initial S/W Revision	Prior to A.02.00

Gate Holdoff

Lets you increase or decrease the wait time after a gate event ends before the analyzer will respond to the next gate signal.

After any Gate event finishes, the analyzer must wait for the sweep system to settle before it can respond to another Gate signal. The analyzer calculates a "wait time," taking into account a number of factors, including RBW and Phase Noise Optimization settings. The goal is to achieve the same accuracy when gated as in ungated operation. The figure below illustrates this concept:

Sweep/Control

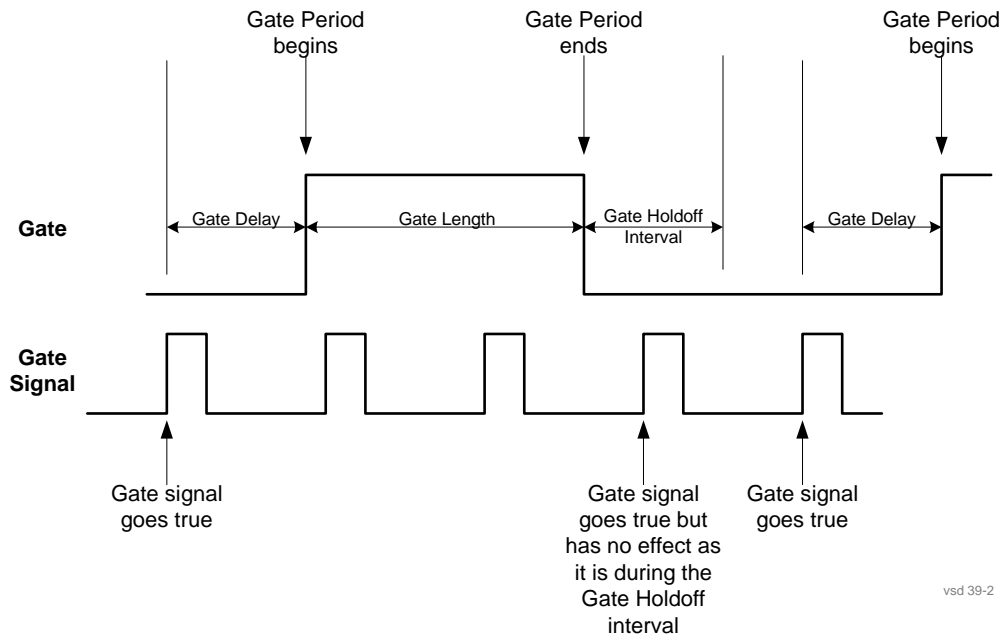

When Gate Holdoff is in Auto, the wait time calculated by the analyzer is used. When Gate Time is in Manual, the user may adjust the wait time, usually decreasing it in order to achieve greater speed, but at the risk of decreasing accuracy.

When the **Method** key is set to **Video** or **FFT**, the **Gate Holdoff** function has no effect.

In measurements that do not support Auto, the value shown when Auto is selected is “---” and the manually set holdoff is returned to a query.

Key Path	Sweep/Control, Gate
Remote Command	<pre>[:SENSe] :SWEep:EGATe:HOLDoff <time> [:SENSe] :SWEep:EGATe:HOLDoff? [:SENSe] :SWEep:EGATe:HOLDoff:AUTO OFF ON 0 1 [:SENSe] :SWEep:EGATe:HOLDoff:AUTO?</pre>
Example	<pre>SWE:EGAT:HOLD 0.0002 SWE:EGAT:HOLD? SWE:EGAT:HOLD:AUTO ON SWE:EGAT:HOLD:AUTO?</pre>

Couplings	<p>When Gate Holdoff is Auto, the Gate Holdoff key shows the value calculated by the analyzer for the wait time.</p> <p>Pressing the Gate Holdoff key while it is in Auto and not selected, causes the key to become selected and allows the user to adjust the value. If the value is adjusted, the setting changes to Man.</p> <p>Pressing the Gate Holdoff key, while it is in Auto and selected, does not change the value of Gate Holdoff, but causes the setting to change to Man. Now the user can adjust the value.</p> <p>Pressing the key while it is in Man and selected, cause the value to change back to Auto.</p> <p>Pressing the key while it is in Man and not selected, causes the key to become selected and allows the user to adjust the value.</p> <p>When Method is set to Video or FFT, the Gate Holdoff function has no effect.</p>
Preset	Auto Auto/On
State Saved	Saved in instrument state
Min	1 μ sec
Max	1 sec
Initial S/W Revision	Prior to A.02.00

Gate Delay Compensation

This function allows you to select an RBW-dependent value by which to adjust the gate delay, to compensate for changes in the delay caused by RBW effects.

You can select between uncompensated operation and two types of compensation, **Delay Until RBW Settled** and **Compensate for RBW Group Delay**.

See [“More Information” on page 1206](#)

Key Path	Sweep/Control, Gate
Scope	Meas Global
Remote Command	<pre>[:SENSe] :SWEep:EGATe:DELay:COMPensation:TYPE OFF SETTled GDELay [:SENSe] :SWEep:EGATe:DELay:COMPensation:TYPE?</pre>
Example	<pre>SWE:EGAT:DEL:COMP:TYPE SETT SWE:EGAT:DEL:COMP:TYPE?</pre>

Notes	<p>Although this function is Meas Global, there are some measurements that do not support this function. In those measurements the operation will be Uncompensated. Going into one of those measurements will not change the Meas Global selection; it will simply display the grayed-out menu key with “Uncompensated” showing as the selection. This is a non-forceful grayout, so the SCPI command is still accepted.</p> <p>If Gate Delay Compensation is not supported at all within a particular mode, the key is not displayed, and if the SCPI command is sent while in a measurement within that mode, an “Undefined Header” error is generated.</p> <p>Measurements that do not support this function include:</p> <p>Swept SA</p>
Preset	<p>TD-SCDMA mode: Compensate for RBW Group Delay</p> <p>All other modes: Delay Until RBW Settled</p>
State Saved	Saved in instrument state
Range	Uncompensated Delay Until RBW Settled Compensate for RBW Group Delay
Readback text	Uncompensated Settled Group Delay
Initial S/W Revision	Prior to A.02.00

More Information

Selecting **Uncompensated** means that the actual gate delay is as you sets it.

Selecting **Delay Until RBW Settled** causes the gate delay to be increased above the user setting by an amount equal to $3.06/\text{RBW}$. This compensated delay causes the GATE START and GATE STOP lines on the display to move by the compensation amount, and the actual hardware gate delay to be increased by the same amount. All the other gate lines (for example, MIN FAST) are unaffected. If the RBW subsequently changes, the compensation is readjusted for the new RBW. The value shown on the **Gate Delay** key does NOT change.

Delay Until RBW Settled allows excellent measurements of gated signals, by allowing the IF to settle following any transient that affects the burst. Excellent measurements also require that the analysis region not extend into the region affected by the falling edge of the burst. Thus, excellent measurements can only be made over a width that declines with narrowing RBWs. Therefore, for general purpose compensation, you will still want to change the gate length with changes in RBW even if the gate delay is compensated.

Selecting **Compensate for RBW Group Delay** causes the gate delay to be increased above the user setting by an amount equal to $1.81/\text{RBW}$. This compensated delay causes the GATE START, GATE STOP lines on the display to move by the compensation amount, and the actual hardware gate delay to be increased by the same amount. All the other gate lines (for example, MIN FAST) are unaffected. If the RBW subsequently changes, the compensation is readjusted for the new RBW. The value shown on the **Gate Delay** key does NOT change. **Compensate for RBW Group Delay** also includes gate length compensation; the gate length itself is adjusted as necessary to attempt to compensate for delay effects imposed by the RBW.

Compensate for RBW Group Delay is similar to **Delay Until RBW Settled** , but compensates for the

group delay of the RBW filter, rather than the filter settling time. As the RBW gets narrow, this can allow the settling tail of the RBW to affect the beginning part of the gated measurement, and allow the beginning of the RBW settling transient to affect the end of the gated measurement. These two effects are symmetric because the RBW response is symmetric. Because the gate length is not automatically compensated, some users might find this compensation to be more intuitive than compensation for RBW settling.

Min Fast Position Query (Remote Command Only)

This command queries the position of the MIN FAST line, relative to the delay reference (REF) line. See section [“Gate View On/Off” on page 1195](#). If this query is sent while not in gate view, the MinFast calculation is performed based on the current values of the appropriate parameters and the result is returned. Knowing this value lets you set an optimal gate delay value for the current measurement setup.

Remote Command	[:SENSe] :SWEep:EGATe:MINFast?
Example	SWE:EGAT:MIN?
Initial S/W Revision	Prior to A.02.00

Points

Sets the number of points taken per sweep, and displayed in the traces. The current value of points is displayed parenthetically, next to the sweep time in the lower-right corner of the display. Using more points provides greater resolution; using fewer points compacts the data and decreases the time required to access a trace over the remote interface.

Increasing the number of points does not increase the sweep time; however, it can slightly impact the trace processing time and therefore the overall measurement speed. Decreasing the number of points does not decrease the sweep time, but it may speed up the measurement, depending on the other sweep settings (for example, in FFT sweeps). Fewer points will always speed up the I/O.

Due to minimum sweep rate limitations of the hardware, the minimum sweep time available to the user will increase above its normal value of 1 ms as the number of sweep points increases above 15001.

Changing the number of sweep points has several effects on the analyzer. The sweep time resolution will change. Trace data for all the traces will be cleared and, if Sweep is in Cont, a new trace taken. If any trace is in average or hold, the averaging starts over.

When in a split screen display each window may have its own value for points.

When sweep points is changed, an informational message is displayed, "Sweep points changed, all traces cleared."

Key Path	Sweep/Control
Remote Command	[:SENSe] :SWEep:POINts <integer> [:SENSe] :SWEep:POINts?
Example	SWE:POIN 5001 SWE:POIN?

Sweep/Control

Dependencies	<ul style="list-style-type: none"> • Grayed out in measurements that do not support swept • Blanked in modes that do not support swept. • Grayed out if Normalize is on; you can't change the number of sweep points with Normalize on, as it will erase the reference trace.
Couplings	<ul style="list-style-type: none"> • When Source Mode is set to Tracking, and Stepped Tracking is used, 201 source steps are used to achieve optimal speed. The number of sweep points in the analyzer is then set to match the number of steps in the source. When Source Mode is set to Off, the previous number of points (the value that existed when Source Mode was Off previously) is restored, even if the user has changed the Points value while the Source Mode was set to Tracking. • Whenever the number of sweep points change: <ul style="list-style-type: none"> — All trace data is erased — Any traces with Update Off will also go to Display Off (like going from View to Blank in the older analyzers) — Sweep time is re-quantized — Any limit lines that are on will be updated — If averaging/hold is on, averaging/hold starts over
Preset	1001
State Saved	Saved in instrument state
Min	Normally the minimum is 1, but in Tracking Source Mode, the minimum value of Points is 101.
Max	40001, or the maximum number of points supported by the source in Tracking Source mode, whichever is less
Initial S/W Revision	Prior to A.02.00
Modified at S/W Revision	A.02.00

Abort (Remote Command Only)

This command is used to stop the current measurement. It aborts the current measurement as quickly as possible, resets the sweep and trigger systems, and puts the measurement into an "idle" state. If the analyzer is in the process of aligning when ABORT is sent, the alignment finishes before the abort function is performed. So ABORT does not abort an alignment.

If the analyzer is set for Continuous measurement, it sets up the measurement and initiates a new data measurement sequence with a new data acquisition (sweep) taken once the trigger condition is met.

If the analyzer is set for Single measurement, it remains in the "idle" state until an:INIT:IMM command is received.

Remote Command	:ABORT
Example	:ABOR

Notes	<p>If: INITiate:CONTInuous is ON, then a new continuous measurement will start immediately; with sweep (data acquisition) occurring once the trigger condition has been met.</p> <p>If :INITiate:CONTInuous is OFF, then :INITiate:IMMEDIATE is used to start a single measurement; with sweep (data acquisition) occurring once the trigger condition has been met.</p>
Dependencies	<p>For continuous measurement, ABORt is equivalent to the Restart key.</p> <p>Not all measurements support the abort command.</p>
Status Bits/OPC dependencies	<p>The STATus:OPERation register bits 0 through 8 are cleared.</p> <p>The STATus:QUESTionable register bit 9 (INTegrity sum) is cleared.</p> <p>Since all the bits that feed into OPC are cleared by the ABORt, the ABORt will cause the *OPC query to return true.</p>
Initial S/W Revision	Prior to A.02.00

Sweep/Control

Trace/Detector

The **Trace/Detector** menu lets you control the acquisition, display, storage, detection and manipulation of trace data for the six available traces. The first page of this menu contains a selection of the trace type (**Clear Write, Trace Average, Max Hold, Min Hold**) for the selected trace. Those choices are described here.

A trace is a series of data points, each having an x and a y value. The x value is usually frequency (or time) and the y value is amplitude. Each data point is referred to as a trace point. In any given trace, trace point 0 is the first point, and trace point (sweep_points – 1) is the last. For example, in a 1001 point trace, the first point is 0 and the last is 1000. Another term sometimes used to describe traces is bucket. A bucket is the frequency span before and after the trace point equal to the point spacing. The y value is measured across (during) this bucket.

For more information see:

[“Trace Update Indicator” on page 1212](#)

[“Trace Annotation” on page 1213](#)

Key Path	Front-panel key
Remote Command	:TRACe [1] 2 3 4 5 6 :TYPE WRITe AVERAge MAXHold MINHold :TRACe [1] 2 3 4 5 6 :TYPE?
Notes	WRITe = Clear Write AVERAge = Trace Average MAXHold = Maximum Hold MINHold = Minimum Hold
Couplings	,Sending a trace command does not cause the specified trace to become selected. Selecting a trace type (pressing any of the four keys or sending a TRAC:TYPE command) puts Update in On and Display in On , even if that trace type was already selected.
Preset	Write. During normal operation of the instrument (that is, other than at powerup), after a mode preset is performed, all active traces are cleared. This is so their domains and initial x values will match the current X Axis of the analyzer. Inactive traces are not cleared after a preset, so a trace which is in Update=On before a preset, and in Update=Off after the preset, will still have the data that it had before the preset.
State Saved	The type of each trace is saved in Instrument State
Initial S/W Revision	Prior to A.02.00

Trace/Detector

Trace Update Indicator

Trace updates can take one of two forms:

The trace is updated in a single operation that affects all of the points in the trace at once. This happens, for example, in the case of very fast (< 200 ms) sweeps, single-chunk FFT's, and the initial math operation after a math function is set for a trace.

The trace is updated in a series of discrete steps, with measurement data being gathered between each step. This will be the case for slow sweeps, multi-chunk FFT's, etc.

In the first case, no update indicator is required. In the second case, however, a visual indicator exists on the trace where the new data is being written, a green "caret" or ^ symbol, which moves across the bottom of the graticule showing the current trace point.

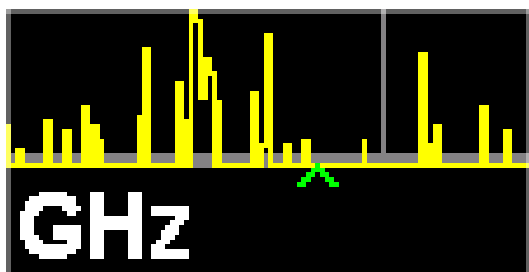

Trace Annunciator Panel

The trace annunciator panel appears on the right hand side of the Meas Bar. Here is an explanation of the fields in this panel:

TRACE	1	2	3	4	5	6
TYPE	W	W	M	A	m	W
DET	N	f	P	S	p	N

On the line labeled "TRACE", each trace number is shown, in the trace color. A green box is drawn around the currently selected trace

Below each trace number, on the line labeled "TYPE", is a letter signifying the trace type for that trace number, where

W=Clear Write
A=Trace Average
M=Max Hold
m=Min Hold

If the letter is white it means the trace is being updated (**Update = On**); if the letter is dimmed, it means the trace is not being updated (**Update = Off**). A strikethrough (e.g., W) indicates that the trace is blanked (**Display = Off**). Note that it is possible for a trace to be updating and blanked, which is useful if the trace is a trace math component.

The third line, labeled "DET", shows the detector type for each trace, or, if trace math is on for that trace,

it shows an “f” (for “math function”). It is not always possible to have a unique detector for each trace, but the analyzer hardware provides the maximum flexibility of detector selection in order to maintain the highest accuracy. The letters used for this readout are:

N=Normal
 A=Average
 P=peak
 p=negative peak
 S=Sample
 Q=Quasi Peak
 E=EMI Average
 R=RMS Average
 f=math function

If the DET letter is green it means the detector is in Auto; if it is white it means the detector has been manually selected.

Trace Annotation

When Trace Annotation (see View/Display menu) is On, each non-blanked trace is labeled on the trace with the detector used to take it, unless a trace math function is on for that trace, in which case it is labeled with the math function.

The detector labels are:

- NORM =Normal
- PEAK =Peak
- SAMP =Sample
- NPEAK =Negative Peak
- RMS =Average detector with Power Average (RMS)
- LG AVG =Average detector with Log-Pwr Average
- VAVG =Average detector with Voltage Average
- QPEAK =Quasi Peak
- EMI AVG =EMI Average
- RMS AVG =RMS Average

The trace math labels are:

- PDIF =Power Difference
- PSUM =Power Sum
- LOFF =Log Offset
- LDIF =Log Difference

Select Trace

Determines which trace the type control keys will affect. Press **Trace** until the number of the desired

Trace/Detector

trace is underlined.

Key Path	Trace/Detector
Preset	Trace 1
State Saved	The number of the selected trace is saved in Instrument State
Initial S/W Revision	Prior to A.02.00

Clear Write

In **Clear Write** type each trace update replaces the old data in the trace with new data. Pressing the **Clear Write** key for the selected trace, or sending the TRAC:TYPE WRIT command for the specified trace, sets the trace type to **Clear Write** and causes the trace to be cleared. Then a new sweep is initiated.

Because pressing **Clear Write** stops the current sweep and initiates a new one, **Trace Average**, **Max Hold** and **Min Hold** data may be interrupted in mid-sweep, and may not accurately reflect the displayed count. Therefore, when **Clear Write** is pressed for one trace, **Trace Average**, **Max Hold** and **Min Hold** must restart for all traces.

When in **Clear Write**, if a measurement-related instrument setting is changed, a new sweep is initiated but the trace is not cleared.

Key Path	Trace/Detector
Example	TRAC:TYPE WRIT
Notes	See “Trace/Detector” on page 1211 ”.
Couplings	Whenever you press Clear Write or send the equivalent SCPI command, Update is set to On and Display is set to On . Automatic detector selection and the VBW:RBW ratio auto rules both depend on the trace type selections
Preset	After a Preset, any trace that is in Clear Write is cleared (all trace points set to mintracevalue).
State Saved	The type for each trace is saved in Instrument State
Initial S/W Revision	Prior to A.02.00

Trace Average

In **Trace Average** type the analyzer maintains and displays an average trace, which represents the cumulative average on a point-by-point basis of the new trace data and previous averaged trace data. Details of the averaging calculations may be found under [“Average/Hold Number” on page 1097](#) and [“Average Type” on page 1098](#).

See [“Trace Averaging: More Information” on page 1215](#).

Key Path	Trace/Detector
----------	----------------

Example	TRAC2:TYPE AVER
Notes	See “Trace/Detector” on page 1211.
Couplings	Affected by Average Type and Average/Hold Number Whenever you press Trace Average or send the equivalent SCPI command, Update is set to On and Display is set to On . Automatic detector selection and the VBW:RBW ratio auto rules both depend on the trace type selections.
Preset	after a Preset, any trace that is in Trace Average is cleared (all trace points set to mintracevalue).
State Saved	the type for each trace is saved in Instrument State
Initial S/W Revision	Prior to A.02.00

Trace Averaging: More Information

Pressing the **Trace Average** key (for the selected trace), or sending the TRAC:TYPE AVER command (for the specified trace), sets the trace type to **Trace Average** and causes the average to be restarted.

When in **Trace Average**, if a measurement-related instrument setting is changed, the average restarts and a new sweep is initiated but the trace is not cleared.

Restarting the average means:

- The average/hold count k is set to 1, so that the next time the average trace is displayed it simply represents one trace of new data
- A new sweep is initiated.
- Once the new sweep starts, the trace is overwritten with current trace data as the first trace of the new average

Remember that restarting averaging also restarts **Max Hold** and **Min Hold**, as there is only one count for Trace Average and Hold.

Max Hold

In **Max Hold** type the analyzer maintains and displays a max hold trace, which represents the maximum data value on a point-by-point basis of the new trace data and previous trace data.

Pressing the **Max Hold** key for the selected trace, or sending the :TRAC:TYPE MAXH command for the specified trace, sets the trace type to **Max Hold**, causes the trace to be cleared, and causes the **Max Hold** sequence to be restarted.

When in **Max Hold**, if a measurement-related instrument setting is changed, the **Max Hold** sequence restarts and a new sweep is initiated but the trace is not cleared.

Restarting the **Max Hold** sequence means:

- The average/hold count k is set to 1, so that the next time the max hold trace is displayed it simply represents one trace of new data
- A new sweep is initiated.

Trace/Detector

Remember that restarting **Max Hold** also restarts averaging and **Min Hold**, as there is only one count for Trace Average and Hold.

Key Path	Trace/Detector
Example	TRAC4:TYPE MAXH
Notes	See “Trace/Detector” on page 1211 ”.
Couplings	Affected by Average Type and Average/Hold Number Whenever you press Max Hold or send the equivalent SCPI command, Update is set to On and Display is set to On . Automatic detector selection and the VBW:RBW ratio auto rules both depend on the trace type selections.
Preset	After a Preset, any trace that is in Max Hold is cleared (all trace points set to mintracevalue).
State Saved	The type for each trace is saved in Instrument State
Initial S/W Revision	Prior to A.02.00

Min Hold

In **Min Hold** type the analyzer maintains and displays a min hold trace, which represents the minimum data value on a point-point basis of the new trace data and previous trace data. Details of the count limiting behavior may be found under [“Average/Hold Number” on page 1097](#).

Pressing the **Min Hold** key for the selected trace, or sending the TRAC:TYPE MINH command for the specified trace, sets the trace type to **Min Hold**, causes the trace to be cleared, and causes the **Min Hold** sequence to be restarted.

When in **Min Hold**, if a measurement-related instrument setting is changed, the **Min Hold** sequence restarts and a new sweep is initiated but the trace is not cleared.

Restarting the **Min Hold** sequence means:

- The average/hold count k is set to 1, so that the next time the min hold trace is displayed it simply represents one trace of new data
- A new sweep is initiated.

Remember that restarting **Min Hold** also restarts **Max Hold** and averaging, as there is only one count for Trace Average and Hold.

Key Path	Trace/Detector
Example	TRAC3:TYPE MINH
Notes	See “Trace/Detector” on page 1211 ”.

Couplings	Affected by Average Type and Average/Hold Number . Whenever you press Min Hold or send the equivalent SCPI command, Update is set to On and Display is set to On . Automatic detector selection and the VBW:RBW ratio auto rules both depend on the trace type selections.
Preset	After a Preset, any trace that is in Min Hold is cleared (all trace points set to maxtracevalue).
State Saved	The type for each trace is saved in Instrument State
Initial S/W Revision	Prior to A.02.00

View/Blank

This key lets you set the state of the two trace variables, Update and Display. The four choices available in this 1-of-N menu are:

- Trace On: Update and Display both On
- View: Update Off and Display On
- Blank: Update Off and Display Off
- Background: Update On, Display Off (this allows a trace to be blanked and continue to update “in the background”, which was not possible in the past)

A trace with Display Off is indicated by a strikethrough thru the type letter in the trace annotation panel in the Measurement bar. A trace with Update Off is indicated by dimming the type letter in the trace annotation panel in the Measurement bar. So in the example below, Traces 3, 4, 5 and 6 have Update Off and Traces 4 and 6 have Display Off.

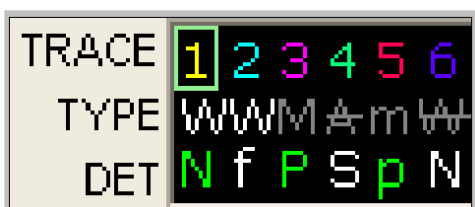

See [“Trace Update State On/Off”](#) on page 1219.

See [“Trace Display State On/Off”](#) on page 1219.

See [“More Information”](#) on page 1219.

Key Path	Trace/Detector
----------	----------------

Trace/Detector

Notes	<p>The four states of this 1-of-N actually set two variables, Update and Display, to their four possible combinations:</p> <ul style="list-style-type: none">• Trace On: Update and Display both On• View: Update Off and Display On• Blank: Update Off and Display Off• Background: Update On, Display Off <p>See tables below for detail on the SCPI to control these two variables.</p>
Couplings	<p>Selecting a trace type (Clear Write, Trace Average, Max Hold, Min Hold) for a trace (pressing the key or sending the equivalent SCPI command) puts the trace in Trace On (Update On and Display On), even if that trace type was already selected.</p> <p>Selecting a detector for a trace (pressing the key or sending a [:SENS]:DET:TRAC command) puts the trace in Trace On (Update On and Display On), even if that detector was already selected.</p> <p>Selecting a math mode other than Off for a trace (pressing the key or sending the equivalent SCPI command) puts the trace in Trace On (Update On and Display On), even if that math mode was already selected.</p> <p>Loading a trace from a file puts that trace in View regardless of the state it was in when it was saved; as does being the target of a Copy or a participant in an Exchange.</p>
Initial S/W Revision	Prior to A.02.00

Trace Update State On/Off

Key Path	Trace/Detector
Remote Command	:TRACe [1] 2 3 4 5 6 :UPDate [:STATe] ON OFF 0 1 :TRACe [1] 2 3 4 5 6 :UPDate [:STATe] ?
Example	TRAC2:UPD 0 Makes trace 2 inactive (stops updating)
Couplings	Whenever you set Update to On for any trace, the Display is set to On for that trace.
Preset	1 0 0 0 0 0 (On for Trace 1; Off for 2–6)
State Saved	Saved in Instrument State
Initial S/W Revision	Prior to A.02.00

Trace Display State On/Off

Key Path	Trace/Detector
Remote Command	:TRACe [1] 2 3 4 5 6 :DISPlay [:STATe] ON OFF 0 1 :TRACe [1] 2 3 4 5 6 :DISPlay [:STATe] ?
Example	TRAC2:DISP,1 Makes trace 2 visible TRAC3:DISP,0 Blanks trace 3
Couplings	Whenever you set Update to On for any trace, the Display is set to On for that trace.
Preset	1 0 0 0 0 0 (On for Trace 1; Off for 2–6)
State Saved	Saved in Instrument State
Initial S/W Revision	Prior to A.02.00

More Information

When a trace becomes inactive, the following things happen:

- Any update from the SENSE system (detectors) immediately stops (does not wait for end of sweep)
- the trace is displayed at half intensity (as long as it stays inactive)

Inactive traces display across the entire X Axis of the instrument. Their horizontal placement does not change even if X Axis settings subsequently are changed, although Y-axis settings will affect the vertical placement of data.

In most cases, inactive traces are static and unchanging; however, there are cases when an inactive trace will update, specifically:

- if data is written to that trace from remote
- if trace data is loaded from mass storage

Trace/Detector

- if the trace is the target of a Copy or participant in an Exchange
- if the trace is cleared using the Clear Trace function (below)

When a trace becomes active (Update=On), the trace is cleared, the average count is reset, and a new sweep is initiated.

Traces which are blanked (Display=off) do not display nor appear on printouts but are otherwise unaffected. They may be queried and markers may be placed on them.

Note that the action of putting a trace in Display=Off and/or Update=Off does not restart the sweep and does not restart Averaging or Hold functions for any traces.

Note also that whenever you set **Update** to **On** for any trace, **Display** is set to **On** for that trace.

Detector

Selects a detector. The detector selected is then applied to the selected trace.

For the SCPI UI, two commands are provided. One is a legacy command, which affects all traces. There is also a command which is new for the X-Series, which uses a subopcode to specify to which trace the specified detector is to be applied.

The three detectors on the second page of the Detector menu, Quasi Peak, EMI Average, and RMS Average, are referred to collectively as the “CISPR detectors” because their behaviors are specified by the CISPR 16-1-1 specification.

See “[More Information](#)” on page 1222

Key Path	Trace/Detector
Remote Command	[:SENSe] :DETECTOR:TRACe [1] 2 3 4 5 6 AVERAge NEGAtive NORMAl POSItive SAMPlE QPEak EAVERage RAVERage [:SENSe] :DETECTOR:TRACe [1] 2 3 4 5 6?
Example	DET:TRAC AVER -- Sets trace 1's detector to average DET:TRAC1 AVER -- Sets trace 1's detector to average DET:TRAC2 SAMP -- Sets trace 2's detector to sample
Notes	When a detector selection is made, the menu returns to the previous menu. Selecting any CISPR detector on any active trace sets the EMI Standard to CISPR.

Notes	<p>The query returns a name that corresponds to the detector type as shown below, and indicates the setting for Trace 1.</p> <p>String ReturnedDefinition</p> <ul style="list-style-type: none"> • NORM =Normal • AVER =Average / RMS • POS =Positive peak • SAMP =Sample • NEG =Negative peak • QPE =Quasi Peak • EAV =EMI Average • RAV =RMS Average
Dependencies	<p>When Tune & Listen is turned on, or Demod Audio is the selected Analog Output:</p> <ul style="list-style-type: none"> • all active traces are forced to use the same detector. • CISPR detectors (QPD, EMI Avg, RMS Avg) are unavailable <p>CISPR detectors are grayed out when you have manually selected FFT sweep. Conversely, if any CISPR detector is selected on an active trace, the auto rules for sweep type will never select FFT, and manual FFT selection will be grayed out.</p> <p>If the grayed out key is pressed, an advisory message is generated. If the equivalent SCPI command is sent, this same message is generated as part of a “-221, Settings conflict” warning.</p>
Couplings	<p>The auto detector rules depend upon marker type, averaging state and type, trace state writing mode, and trace active state.</p> <p>If the Avg Type is in Auto, and any of the CISPR detectors is selected on any active trace, the Voltage Averaging type is auto-selected.</p>
Preset	<p>Preset returns all traces to “auto”, which will result in Normal (Rosenfell) detection for all traces.</p>
State Saved	<p>Saved in instrument state</p>
Initial S/W Revision	<p>Prior to A.02.00</p>
Modified at S/W Revision	<p>A.02.00</p>
Remote Command	<pre>[:SENSE] :DETector [:FUNCTION] NORMAL AVERAGE POSITIVE SAMPLE NEGATIVE QPEAK EAVERAGE EPOSITIVE MPOSITIVE RMS [:SENSE] :DETector [:FUNCTION] ?</pre>
Example	<p>DET AVER Sets detector to average for all traces</p> <p>DET:FUNC? Returns trace 1’s detector setting</p>

Trace/Detector

Notes	<p>This is a SCPI only legacy command to preserve the classic functionality wherein all traces are affected when a detector is selected.</p> <p>The query returns a name that corresponds to the detector type as shown below, and indicates the setting for Trace 1.</p> <p>The RMS selection sets the detector type to AVERage and the Average Type to RMS. Therefore if RMS has been selected, the query will return the "AVER" string.</p> <p>The EPOS selection sets the detector type to Peak and the EMI Standard to CISPR. A query will then return POS</p> <p>The MPOS selection sets the detector type to Peak and the EMI Standard to MIL Impluse. A query will then return POS</p> <p>The RAV parameter is not included in the command because this is not a legacy detector; nonetheless, if it happens to be the detector on Trace 1 then RAV will be returned.</p> <p>String ReturnedDefinition</p> <ul style="list-style-type: none">• NORM =Normal• AVER =Average / RMS• POS =Positive peak• SAMP =Sample• NEG =Negative peak• QPE =Quasi Peak• EAV =EMI Average• RA =RMS Average
Preset	NORMal
State Saved	Saved in instrument state
Initial S/W Revision	Prior to A.02.00
Modified at S/W Revision	A.02.00

More Information

The available detectors are:

- The Sample detector indicates the instantaneous level of the signal at the center of the bucket represented by each display point.
- The Normal detector determines the peak of CW-like signals, and it yields alternating maximums and minimums of noise-like signals. This is also referred to as Rosenfell detection.
- The Average detector determines the average of the signal within the bucket. The averaging method depends upon Average Type selection (voltage, power or log scales).
- The Peak detector determines the maximum of the signal within the bucket.
- The Negative Peak detector determines the minimum of the signal within the bucket.

- The Quasi-Peak detector is a fast-rise, slow-fall detector used in making CISPR compliant EMI measurements.
- The EMI-Average detector provides a standard means to “smooth” the signal while still providing compliance to CISPR pulse response standards. It displays the average value of the amplitude envelope, rather than the average value of sample-detected amplitude, and uses an advanced algorithm to realize a lowpass filter that conforms to the latest CISPR standard.
- The RMS Average detector is a frequency dependent RMS or Averaging filter, used in making CISPR compliant EMI measurements, which performs one averaging process (in the VBW hardware) on the "power" (a.k.a. RMS) scale, and another process on the voltage scale using a "meter movement simulator". This filter conforms to the 2007 revision of the CISPR 16–1–1 standard.

Because they may not find a spectral component's true peak, neither average nor sample detectors measure amplitudes of CW signals as accurately as peak or normal, but they do measure noise without the biases of peak detection.

When the Detector choice is Auto, the detector selected depends on marker functions, trace functions, average type, and the trace averaging function.

When you manually select a detector (instead of selecting Auto), that detector is used regardless of other analyzer settings.

Multiple Detectors

The analyzer always provides the requested detector on the specified trace. Depending on the detectors requested the analyzer can provide up to three different detectors simultaneously within the constraints of its digital processing algorithms. Some detectors utilize more resources; the Quasi-Peak detector, for example, utilizes most of the digital IF's resources, and the hardware in some analyzers is incapable of providing another detector when Quasi-Peak is on. If the limit of system resources is exceeded, detectors on some existing traces may be forced to change. When this happens, they change to match the detector just requested, and a message is generated: “Detector <X> changed due to physical constraints”, where X might contain multiple values.

Example: User has traces 1, 2, and 3 with Peak, Average, and Negative Peak. User specifies QPD for trace 1. Traces 2 and 3 also change to QPD and we generate the message “Detector 2,3 changed due to physical constraints”. Now all three traces have the QPD.

Auto

This sets the detector for the currently selected trace to Auto. (For SCPI, the trace number is specified as a sub-opcode.) This will immediately apply the auto rules to determine a new detector value.

Key Path	Trace/Detector, Detector
Remote Command	[:SENSE] :DETECTOR:TRACe [1] 2 3 4 5 6 :AUTO ON OFF 1 0 [:SENSE] :DETECTOR:TRACe [1] 2 3 4 5 6 :AUTO?
Example	DET:TRACE2:AUTO ON sets trace 2 detection to automatic.

Trace/Detector

Dependencies	The auto detector rules depend upon marker type, averaging state and type, trace state writing mode, and trace active state. When operating a source in Tracking Source mode, Auto selection is the Average detector. All other detector selections are allowed, but in most cases you will want to stick with Average, which gives optimal sensitivity.
Couplings	Selecting AUTO, whether by pressing the softkey or sending the equivalent SCPI command, will turn trace math to Off for the selected/specified trace.
Preset	Auto (On) for all detectors.
State Saved	Saved in instrument state
Initial S/W Revision	Prior to A.02.00

Remote Command	[:SENSE] :DETECTOR:AUTO ON OFF 1 0 [:SENSE] :DETECTOR:AUTO?
Example	DET:AUTO ON
Notes	SCPI only. Turns AUTO on or off for ALL detectors. This is a legacy command to preserve the classic functionality wherein all traces are affected when a detector is addressed
Notes	The query returns the Auto state of Trace 1.
Initial S/W Revision	Prior to A.02.00

Normal

This sets the detector for the current selected trace to Normal (Rosenfell).

When the signal is CW-like, it displays the peak-detected level in the interval (bucket) being displayed. If the signal is noise-like (within a bucket the signal both rose and fell), it alternates displaying the max/min values. That is, an even bucket shows the peak (maximum) within a two-bucket wide interval centered on the even bucket. And an odd bucket will show the negative peak (minimum) within a two-bucket wide interval. For example, for an even bucket the two-bucket wide interval is a combination of one-half bucket to the left of the even bucket, the even bucket itself, and one-half bucket to the right of the even bucket, so the peak found will be displayed in the correct relative location on screen. The odd buckets are similar.

Key Path	Trace/Detector, Detector
Example	DET:TRAC3 NORM sets the detector to normal for trace 3.
Dependencies	Selecting any detector (even the currently selected detector) for a given trace turns Update and Display on for that trace. Normal detector is grayed out when the X scale is Log.

Couplings	<p>Selecting a specific detector type turns “Auto” to false for this trace (manual).</p> <p>Selecting a detector for a trace (pressing the key or sending a [:SENS]:DET:TRAC command) puts Update On and Display On for that trace, even if that detector was already selected. Note that the legacy command [:SENS]:DET[:FUNC] does NOT exhibit this behavior.</p> <p>Selecting a detector, whether by pressing the softkey or sending the equivalent SCPI command, will turn trace math to Off for the selected/specified trace.</p>
Initial S/W Revision	Prior to A.02.00

Average (Log/RMS/V)

For each bucket (interval) in the trace, Average detection displays the average of the amplitude within the bucket using one of the following averaging methods:

- Log power (also known as video)
- Power (also known as RMS)
- Voltage envelope

To explicitly set the averaging method, use the **Meas Setup, Average Type** key. When you are using average detection with the Power method is equivalent to what is sometimes referred to as “RMS detection”. The detailed information about the different types of averaging is found in **Average Type** in the **Meas Setup** key menu.

Key Path	Trace/Detector, Detector
Example	DET:TRAC3 AVER sets the detector to average for trace 3.
Notes	<p>For the specific case of a customer wanting RMS detection, they need to set the averaging type to RMS, and also select average detection for the trace:</p> <p>AVER:TYPE RMS</p> <p>DET:TRAC AVER</p>
Dependencies	Selecting any detector (even the currently selected detector) for a given trace turns Update and Display on for that trace.

Trace/Detector

Couplings	<p>Selecting a specific detector type turns “Auto” to false for this trace (manual).</p> <p>Selecting a detector for a trace (pressing the key or sending a [:SENS]:DET:TRAC command) puts Update On and Display On for that trace, even if that detector was already selected. Note that the legacy command [:SENS]:DET[:FUNC] does NOT exhibit this behavior.</p> <p>Selecting a detector, whether by pressing the softkey or sending the equivalent SCPI command, will turn trace math to Off for the selected/specified trace.</p> <p>The VBW filter is not used for this detector, so varying the VBW will have no effect for any traces for which this detector is selected (other than to slow down the sweep, because of the coupling to Sweep Time of VBW). If any traces are active for which VBW does not apply (traces with Average, EMI Average, RMS Average or Quasi Peak detectors), then an * displays after the VBW annotation on the front panel.</p> <p>Use of the Average detector affects the VBW setting because of its effect on the VBW/RBW coupling. See the BW section under the key ““Video BW ” on page 947”.</p>
Initial S/W Revision	Prior to A.02.00

Peak

For each bucket (interval) in the trace, Peak detection displays the highest amplitude within the bucket.

Peak detection is used for CW measurements and some pulsed-RF measurements. For FFT analysis, the highest amplitude across the frequency width of a bucket is displayed, even if that peak amplitude falls between samples of the spectrum computed in the FFT process.

Key Path	Trace/Detector, Detector
Example	DET:TRAC2 POS sets the detector to peak for trace 2.
Couplings	<p>Selecting a specific detector type turns “Auto” to false for this trace (manual).</p> <p>Selecting a detector for a trace (pressing the key or sending a [:SENS]:DET:TRAC command) puts Update On and Display On for that trace, even if that detector was already selected. Note that the legacy command [:SENS]:DET[:FUNC] does NOT exhibit this behavior.</p> <p>Selecting a detector, whether by pressing the softkey or sending the equivalent SCPI command, will turn trace math to Off for the selected/specified trace.</p>
Initial S/W Revision	Prior to A.02.00

Sample

The sample detector displays the instantaneous level of the signal at the center of the bucket (interval) represented by each trace point.

Sample detection is good for displaying noise or noise-like signals.

Sample detection is not the best for making amplitude measurements of CW-like signals for two reasons. First, the peak response to a signal can occur between samples. So unless the Span to RBW ratio is lower than usual, then the highest sample can be well below the peak signal amplitude. Second, for the high

sweep rates normally used, the peak response of the RBW filters is up to -0.5 dB. This sweeping error is compensated when using the peak and normal detectors by changing the overall gain. But the gain is not changed when in the sample detector, because doing so would cause errors in the response to noise. Instead, the auto-couple rules for sweep time are modified to give slower sweeps.

Key Path	Trace/Detector, Detector
Example	DET:TRAC SAMP selects the Sample detector for trace 1.
Couplings	<p>Selecting a specific detector type turns “Auto” to false for this trace (manual).</p> <p>Selecting a detector for a trace (pressing the key or sending a [:SENS]:DET:TRAC command) puts Update On and Display On for that trace, even if that detector was already selected. Note that the legacy command [:SENS]:DET[:FUNC] does NOT exhibit this behavior.</p> <p>Selecting a detector, whether by pressing the softkey or sending the equivalent SCPI command, will turn trace math to Off for the selected/specified trace.</p>
Initial S/W Revision	Prior to A.02.00

Negative Peak

For each bucket (interval) in the trace, Negative Peak detection displays the lowest sample within the bucket. Negative peak detection is similar to peak detection, but selects the minimum video signal.

Key Path	Trace/Detector, Detector
Example	DET:TRAC2 NEG selects the negative peak detector for trace 2.
Couplings	<p>Selecting a specific detector type turns “Auto” to false for this trace (manual).</p> <p>Selecting a detector for a trace (pressing the key or sending a [:SENS]:DET:TRAC command) puts Update On and Display On for that trace, even if that detector was already selected. Note that the legacy command [:SENS]:DET[:FUNC] does NOT exhibit this behavior.</p> <p>Selecting a detector, whether by pressing the softkey or sending the equivalent SCPI command, will turn trace math to Off for the selected/specified trace.</p>
Initial S/W Revision	Prior to A.02.00

Quasi Peak

Only appears with Option EMC installed and licensed.

This is a fast-rise, slow-fall detector used in making CISPR compliant EMI measurements and defined by CISPR Publication 16–1–1. Quasi-peak detection displays a weighted, sample-detected amplitude using specific, charge, discharge, and meter time constants derived from the legacy behaviors of analog detectors and meters. It is used for EMI measurements to provide a specific and consistent response to EMI-like signals.

Note that CISPR standard operation is to perform the averaging associated with quasi peak detection on the voltage scale. You can manually set the Average Type to Log-Power or Power, but the results will no longer be CISPR compliant.

Trace/Detector

See “More Information” on page 1228.

Key Path	Trace/Detector, Detector
Example	DET:TRAC3 QPE selects the quasi-peak detector for trace 3.
Dependencies	Unavailable in manual FFT sweep. Unavailable when Tune & Listen is turned on, or Demod Audio is the selected Analog Output:
Couplings	<p>If the user selects this detector on any active trace, the EMI Standard will be set to CISPR. If any inactive trace with this detector selected goes active, the EMI Standard is set to CISPR.</p> <p>If the Avg Type is in Auto, and this detector is selected on any active trace, the Voltage Averaging type is auto-selected.</p> <p>The VBW filter is not used for this detector, so varying the VBW will have no effect for any traces for which this detector is selected (other than to slow down the sweep, because of the coupling to Sweep Time of VBW). If any traces are active for which VBW does not apply (traces with Average, EMI Average, RMS Average or Quasi Peak detectors), then an * displays after the VBW annotation on the front panel.</p> <p>Selecting a specific detector type turns the ““Auto ” on page 1223” (to false for this trace (manual).</p> <p>Selecting a detector for a trace (pressing the key or sending a [:SENS]:DET:TRAC command) puts Update On and Display On for that trace, even if that detector was already selected. Note that the legacy command [:SENS]:DET[:FUNC] does NOT exhibit this behavior.</p> <p>Selecting a detector, whether by pressing the softkey or sending the equivalent SCPI command, will turn trace math to Off for the selected/specified trace.</p>
Initial S/W Revision	A.02.00

More Information

In the past, Quasi Peak and EMI Average measurements were often made on a linear display scale because those detectors only worked properly with signals on a linear (voltage) scale. The X-series analyzers are capable of making Quasi Peak and EMI Average detected measurements correctly on a log scale, due to the digital IF. This latter capability means that the user can observe detected EMI levels on a log scale, allowing a large visible dynamic range.

Also in the past, EMI analysis equipment would need to perform a ranging operation to set the reference level when one of these detectors was turned on, but the X-series analyzers do not - because of its digital IF, there is no need to set the reference level (range) to improve the accuracy nor to allow visibility of the detected level.

EMI Average

Only appears with Option EMC installed and licensed.

The EMI Average detector in Agilent’s X-Series analyzers is so called to distinguish it from the Average detector, although EMI users typically refer to it simply as the “Average detector”. The intent of this

detector is to provide a standard means to “smooth” the signal while still providing compliance to CISPR pulse response standards

Unlike the regular Average detector, the EMI Average detection displays the average value of the amplitude envelope, rather than the average value of sample-detected amplitude. It is defined for EMI measurements by the CISPR 16–1–1 standard and, in the X-series, uses a sophisticated algorithm to implement a lowpass filter that conforms to the latest CISPR standard.

Note that CISPR standard operation is to perform the envelope averaging on the voltage scale. You can manually set the Average Type to Log-Power or Power, but the results will no longer be CISPR compliant.

Key Path	Trace/Detector, Detector
Example	DET:TRAC3 EAV selects the EMI average detector for trace 3.
Dependencies	Unavailable in manual FFT sweep. Unavailable when Tune & Listen is turned on, or Demod Audio is the selected Analog Output:
Couplings	<p>If the user selects this detector on any active trace, the EMI Standard will be set to CISPR. If any inactive trace with this detector selected goes active, the EMI Standard is set to CISPR.</p> <p>If the Avg Type is in Auto, and this detector is selected on any active trace, the Voltage Averaging type is auto-selected.</p> <p>The VBW filter is not used for this detector, so varying the VBW will have no effect for any traces for which this detector is selected (other than to slow down the sweep, because of the coupling to Sweep Time of VBW). If any traces are active for which VBW does not apply (traces with Average, EMI Average, RMS Average or Quasi Peak detectors), then an * displays after the VBW annotation on the front panel.</p> <p>Selecting a detector for a trace (pressing the key or sending a [:SENS]:DET:TRAC command) puts Update On and Display On for that trace, even if that detector was already selected. Note that the legacy command [:SENS]:DET[:FUNC] does NOT exhibit this behavior.</p> <p>Selecting a detector, whether by pressing the softkey or sending the equivalent SCPI command, will turn trace math to Off for the selected/specified trace.</p>
Initial S/W Revision	A.02.00

RMS Average

Only appears with Option EMC installed and licensed.

This key selects the RMS Average detector, a frequency dependent RMS/Averaging filter, used in making CISPR compliant EMI measurements. This filter conforms to the 2007 revision of the CISPR 16–1–1 standard.

This detector does one averaging process (in the VBW hardware) on the "power" (a.k.a. RMS) scale and another process on the voltage scale using a "meter movement simulator" similar to the one used in the QPD filter.

Trace/Detector

Note that the user can manually set the Average Type to Log-Power or Power, but the results will no longer be CISPR compliant.

Key Path	Trace/Detector, Detector
Example	DET:TRAC3 RAV selects the RMS Average detector for trace 3.
Notes	This key / command is grayed out when you have manually selected FFT sweep.
Dependencies	Unavailable in manual FFT sweep. Unavailable when Tune & Listen is turned on, or Demod Audio is the selected Analog Output:
Couplings	Selecting a detector for a trace (pressing the key or sending a [:SENS]:DET:TRAC command) puts Update On and Display On for that trace, even if that detector was already selected. Note that the legacy command [:SENS]:DET[:FUNC] does NOT exhibit this behavior.
Couplings	<p>If the user selects this detector on any active trace, the EMI Standard will be set to CISPR. If any inactive trace with this detector selected goes active, the EMI Standard is set to CISPR.</p> <p>If the Avg Type is in Auto, and this detector is selected on any active trace, the Voltage Averaging type is auto-selected.</p> <p>The VBW filter is not used for this detector, so varying the VBW will have no effect for any traces for which this detector is selected (other than to slow down the sweep, because of the coupling to Sweep Time of VBW). If any traces are active for which VBW does not apply (traces with Average, EMI Average, RMS Average or Quasi Peak detectors), then an * displays after the VBW annotation on the front panel.</p> <p>Selecting a detector for a trace (pressing the key or sending a [:SENS]:DET:TRAC command) puts Update On and Display On for that trace, even if that detector was already selected. Note that the legacy command [:SENS]:DET[:FUNC] does NOT exhibit this behavior.</p> <p>Selecting a detector, whether by pressing the softkey or sending the equivalent SCPI command, will turn trace math to Off for the selected/specified trace.</p>
Initial S/W Revision	A.02.00

Preset Detectors

The keys in this menu provide a quick way of setting a number of traces to convenient common detector settings. It is important to point out that these are not toggles or ‘modes’, and do not keep any detectors in a particular configuration. The effect is identical to just setting the traces’ detectors individually. These are simply one-time settings that are quicker than making many individual changes.

Key Path	Trace/Detector, Detector
----------	---------------------------------

Dependencies	When you have manually selected FFT sweep, the Detector Preset choices that contain any CISPR detectors, are grayed out. If the grayed out key is pressed, an advisory message is generated. If the equivalent SCPI command is sent, this same message is generated as part of a “-221, Settings conflict” warning.
Preset	No interaction with preset
State Saved	Not saved in state
Initial S/W Revision	Prior to A.02.00

All Traces Auto

This is designed to quickly return the selected set of detectors to the “preset” state, which is auto-selected.

Key Path	Trace/Detector, Detector, Preset Detectors
Couplings	Sets all traces’ Detector Auto to true.
Initial S/W Revision	Prior to A.02.00

Peak / Average / NPeak

This is a setting for making a measurement of the average power and the signal envelope.

Key Path	Trace/Detector, Detector, Preset Detectors
Couplings	Trace 1: Set to peak detection, and Clear-Write. Trace 2: Set to average detection, and Clear-Write. Trace 3: Set to negative peak detection, and Clear-Write.
Initial S/W Revision	Prior to A.02.00

Clear Trace

Clears the selected trace (from the front panel) or the specified trace (from SCPI). Does not affect the state of any function or variable in the instrument. Loads mintracevalue into all of the points in the selected trace, unless the trace is in Min Hold in which case it loads maxtracevalue. It does this even if Update=Off.

This key only appears in the Normal View. It does not appear when in the Spectrogram View.

Key Path	Trace/Detector
Remote Command	:TRACe:CLEAr TRACE1 TRACE2 TRACE3 TRACE4 TRACE5 TRACE6
Example	TRAC:CLE TRACE1 clears trace 1
Initial S/W Revision	Prior to A.02.00

Trace/Detector

Clear All Traces

Clears all traces. Does not affect the state of any function or variable in the instrument. Loads mintracevalue into all of the points all traces, except traces in Min Hold in which case it loads maxtracevalue. Does so even if Update=Off.

This key only appears in the Normal View. It does not appear when in the Spectrogram View.

Key Path	Trace/Detector
Remote Command	:TRACe:CLEAr:ALL
Example	TRAC:CLE:ALL clears all traces
Initial S/W Revision	Prior to A.02.00

Math

This menu lets you turn on trace math functions. Trace math functions perform mathematical operations between traces and, in some cases, user-specified offsets. When in a trace math function, the indicated function is performed during the sweep with the math function used in place of a detector. The trace operands for the math function are set using the **Trace Operands** key.

See [“Math: More Information” on page 1234](#).

This key only appears in the Normal View..

Key Path	Trace/Detector
Remote Command	:CALCulate:MATH TRACE1 TRACE2 TRACE3 TRACE4 TRACE5 TRACE6 , PDifference PSUM LOFFset LDifference OFF , TRACE1 TRACE2 TRACE3 TRACE4 TRACE5 TRACE6 , TRACE1 TRACE2 TRACE3 TRACE4 TRACE5 TRACE6 , <real> , <real> :CALCulate:MATH? TRACE1 TRACE2 TRACE3 TRACE4 TRACE5 TRACE6
Notes	The lower level menu, which contains an embedded 1-of-N, does not auto-return when a selection is made.

Notes	<p>The Trace Math Function command has 6 main set of parameters:</p> <ul style="list-style-type: none"> - Set 1 defines the “result trace”: TRACE1 TRACE2 TRACE3 TRACE4 TRACE5 TRACE6 -Set 2 defines the “function”: PDIFference PSUM LOFFset LDIFference OFF - Set 3 is a “trace operand” (1): TRACE1 TRACE2 TRACE3 TRACE4 TRACE5 TRACE6 - Set 4 is a “trace operand” (2): TRACE1 TRACE2 TRACE3 TRACE4 TRACE5 TRACE6 - Set 5 defines the “Log Offset” (in dB). - Set 6 defines the “Log Difference Reference” (in dBm). <p>Note that the trace math mode is an enumeration; that is, when a math function is set for a trace it turns off any math function that is on for that trace and sets the new math function.</p> <p>The parameters sent in the command are reflected in the values in the softkey menu. There is no default for any parameter; all 6 parameters must be sent to satisfy the parser. Failure to specify a parameter will result in a missing parameter error.</p> <p>Note that for some of the math modes some of the parameters are not relevant. For those modes, the parameters are ignored, and sending “,” is sufficient for those parameters.</p> <p>The query returns the math mode, the operand traces, the offset and the reference for the specified trace, all separated by commas. The return value of irrelevant parameters is undefined; empty fields (“,”) would be desirable.</p> <p>Remote command examples are included in each section below.</p>
Dependencies	<p>Trace Math is not available if Normalize is on.</p> <p>None of the trace operands can be the destination trace. If any of the three trace math commands is sent with a destination trace number matching one of the operands a warning is generated and the function does not turn on.</p>
Couplings	<p>Whenever a math function is turned on for a trace, that trace is set to Display=On and Update=On.</p>
Preset	<p>OFF,TRACE5,TRACE6,0,0 OFF,TRACE6,TRACE1,0,0 OFF,TRACE1,TRACE2,0,0 OFF,TRACE2,TRACE3,0,0 OFF,TRACE3,TRACE4,0,0 OFF,TRACE4,TRACE5,0,0</p>
State Saved	<p>The trace math function for each trace is saved in Instrument State.</p>
Status Bits/OPC dependencies	<p>*OPC can be used to detect the completion of a sweep, which will also correspond to the completion of the math operation, since all math takes place during the sweep</p>
Initial S/W Revision	<p>Prior to A.02.00</p>

Math: More Information

IMPORTANT: to generate a trace math result, you must take a sweep. The trace math engine, described below, operates in concert with the sweep engine in the analyzer. Until a sweep has been taken, even if the constituent traces are not in Update mode, no result is generated. Note that certain events can affect the trace in ways that affects all points at once. This can happen in any number of ways, including:

- A trace clear taking place
- A trace being loaded from the file system
- Trace data being sent in from the remote interface
- A copy or exchange of trace data

You should try to avoid these occurrences during a sweep, as they will tend to invalidate the math result being accumulated.

How trace math is processed:

Whenever a trace math function is turned on, or the parameters and/or operands of an existing trace math function are changed, the destination trace is cleared. After the trace is cleared, all x-axis values in the trace, and the domain of the trace, are set to match the X Axis settings of the first trace operand. When this is complete, a new sweep is initiated.

The process of acquiring data, processing it using the math and average/hold functions, and presenting it to the user as trace data, consists of several functional blocks, as shown below:

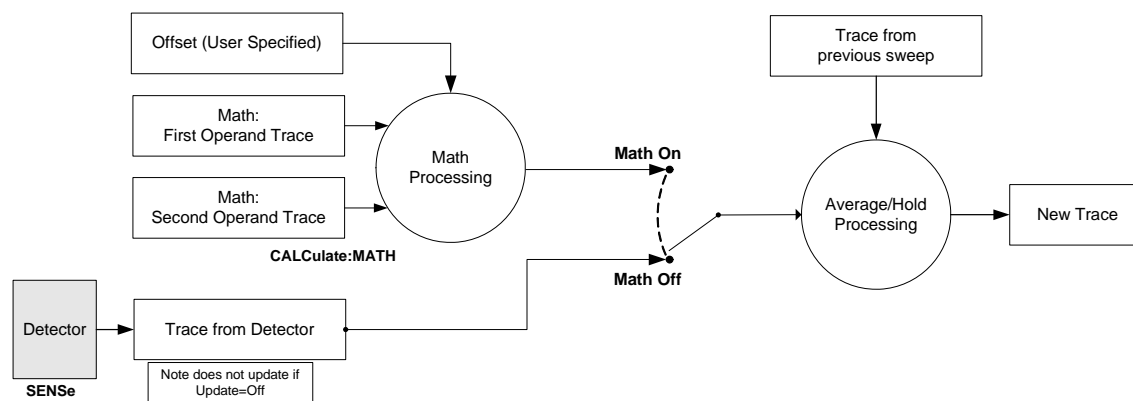

For each active trace, the current trace point is processed for Trace 1, then Trace 2, then Trace 3, etc. Trace data is taken from either the detector for that trace, or from the mathematical result of up to two other traces and an offset, depending on whether trace math is on or not. The resultant data is then fed to the Average/Hold processing block, where (if the trace type is Average, Max Hold, or Min Hold) it is processed with previous trace data. The new trace data resulting from this process is then available for display, storage or remote output.

When the processing is complete for Trace 1, Trace 2 is processed, and so on until all six traces have been processed. This allows a downstream trace to use as one of its math components a fully processed upstream trace. In other words, if math is on for Trace 4, and its operand traces are Trace 2 and Trace 3, all detector, math, average and hold processing for traces 2 and 3 is complete before the math is performed for trace 4. When the current trace point is completed for all traces, the analyzer moves on to the next trace point.

Power Diff (Op1-Op2)

Calculates a power difference between the **First Trace** operand and the **Second Trace** operand and puts the result in the destination trace.

During the sweep, the following formula is executed for each point in the trace operands, and the corresponding point is generated for the destination trace:

$$\text{DestinationTrace} = 10 \log(10(1/10)(\text{FirstTrace}) - 10(1/10)(\text{SecondTrace}))$$

The values of the trace points are assumed to be in a decibel scale, as they are internally stored.

If a point in FirstTrace is equal to maxtracevalue, the resultant point is also maxtracevalue.

Otherwise, if the result of the subtraction is less than or equal to 0, the resultant point is mintracevalue.

Key Path	Trace/Detector, Math
Example	:CALC:MATH TRACE1,PDIF,TRACE4,TRACE5,, sets Trace 1 to Power Diff trace math function, and sets the First Trace operand (for Trace 1) to Trace 4 and the Second Trace operand (for Trace 1) to Trace 5.
Couplings	Selecting a math mode other than Off for a trace (pressing the key or sending the equivalent SCPI command) puts the trace in View (Update On and Display On), even if that math mode was already selected.
Initial S/W Revision	Prior to A.02.00

Power Sum (Op1+Op2)

Calculates a power sum between the **First Trace** operand and the **Second Trace** operand and puts the result in the destination trace.

During the sweep, the following formula is executed for each point in the trace operands, and the corresponding point is generated for the destination trace.:

$$\text{DestinationTrace} = 10 \log(10(1/10)(\text{FirstTrace}) + 10(1/10)(\text{SecondTrace}))$$

The values of the trace points are assumed to be in a decibel scale, as they are internally stored.

If a point in either trace operand is equal to maxtracevalue, the resultant point is also maxtracevalue.

Key Path	Trace/Detector, Math
Example	:CALC:MATH TRACE1,PSUM,TRACE4,TRACE5,, sets Trace 1 to Power Sum trace math function and sets the First Trace operand (for Trace 1) to Trace 4 and the Second Trace operand (for Trace 1) to Trace 5.
Couplings	Selecting a math mode other than Off for a trace (pressing the key or sending the equivalent SCPI command) puts the trace in View (Update On and Display On), even if that math mode was already selected.
Initial S/W Revision	Prior to A.02.00

Trace/Detector

Log Offset (Op1 + Offset)

Calculates a log offset from the **First Trace** operand and puts the result in the destination trace. This is like the B-DL function in some older analyzers. The offset is entered as the active function. Each destination trace has its own offset.

During the sweep, the following formula is executed for each point in the trace operand, and the corresponding point is generated for the destination trace.:

$$\text{DestinationTrace} = \text{FirstTrace} + \text{Offset}$$

The values of the trace points are assumed to be in dBm (as they are internally stored) and the offset is in dB.

If a point in the trace operand is equal to maxtracevalue, the resultant point is also maxtracevalue.

If a point in the trace operand is equal to mintracevalue, the resultant point is also mintracevalue.

Example: If offset is 25 dB, then our destination trace will be higher than the operand trace by 25 dB.

Note that the **Second Trace** operand is not used for this function.

Key Path	Trace/Detector, Math
Example	:CALC:MATH TRACE1,LOFF,TRACE4,,-6.00, sets Trace 1 to Log Offset trace math function, sets the First Trace operand (for Trace 1) to Trace 4, leaves the Second Trace operand (for Trace 1) unchanged (it is irrelevant for this function) and sets the Log Offset (for Trace 1) to -6 dB.
Couplings	Selecting a math mode other than Off for a trace (pressing the key or sending the equivalent SCPI command) puts the trace in View (Update On and Display On), even if that math mode was already selected.
State Saved	The Log Offset value for each trace is saved in Instrument State
Min	-100 dB
Max	100 dB
Initial S/W Revision	Prior to A.02.00

Log Diff (Op1-Op2+Ref)

Offsets the difference between the **First Trace** operand and the **Second Trace** operand by a reference and puts the result in the destination trace. This is like the A-B+DL function in some older analyzers. The reference is entered as the active function. Each destination trace has its own reference.

During the sweep, the following formula is executed for each point in the trace operands, and the corresponding point is generated for the destination trace:

$$\text{DestinationTrace} = (\text{FirstTrace} - \text{SecondTrace}) + \text{Reference}$$

The values of the operand trace points are assumed to be in decibel units (as they are internally stored) and the reference is in dBm so the result is in dBm.

Example: If the first operand trace 1 is at 5 dBm, the second operand trace 2 is at -5 dBm, and the

reference is -25 dBm, then the destination trace will be -15 dBm.

Example: If the first operand trace1 is at 60 dBuV, the second operand trace 2 is at 50 dBuV, and the reference is 35 dBuV, then the destination trace will be 45 dBuV.

See “[More Information](#)” on page 1237.

Key Path	Trace/Detector, Math
Example	:CALC:MATH TRACE1,LDIF,TRACE4,TRACE5,-6.00 sets Trace 1 to Log Diff trace math function, sets the First Trace operand (for Trace 1) to Trace 4, sets the Second Trace operand (for Trace 1) to Trace 5, and sets the Log Difference reference for Trace 1 to -6 dBm.
Couplings	Selecting a math mode other than Off for a trace (pressing the key or sending the equivalent SCPI command) puts the trace in View (Update On and Display On), even if that math mode was already selected.
State Saved	The Log Difference reference value for each trace is saved in Instrument State
Min	Same as reference level
Max	Same as reference level
Initial S/W Revision	Prior to A.02.00
Default Unit	depends on the current selected Y axis unit

More Information

If a point in FirstTrace is equal to maxtracevalue, the resultant point is also maxtracevalue.

If a point in FirstTrace is equal to mintracevalue, the resultant point is also mintracevalue.

If neither of the above is true for a given point, then:

- If that point in SecondTrace is equal to maxtracevalue, the resultant point is mintracevalue.
- If that point in SecondTrace is equal to mintracevalue, the resultant point is maxtracevalue.

Off

Turns off Trace Math.

Key Path	Trace/Detector, Math
Example	CALC:MATH TRACE1 OFF turns off trace math for trace 1.
Notes	See Trace “Math”.
State Saved	The current trace math function is saved in Instrument State
Readback	Off
Initial S/W Revision	Prior to A.02.00

Trace/Detector

Trace Operands

Selects the trace operand(s) to be used for the trace math functions for the destination trace.

Key Path	Trace/Detector, Math
Notes	The operands of the trace math commands specify the trace operands. Since the operands are common to all math functions for a given trace, the most recently sent math function command sets the operands for each trace and are reflected on the trace operand keys.
Dependencies	The destination trace cannot be an operand.
Readback line	In square brackets, the First Trace operand, new line, and the second trace operand, as: [Op1=Trace 1, Op2=Trace2] where Trace 1 is operand 1 and Trace 2 is operand 2.
Initial S/W Revision	Prior to A.02.00

Operand 1

Selects the first trace operand to be used for the trace math functions for the destination trace.

Key Path	Trace/Detector, Math, Trace Operands
Dependencies	The First Trace cannot be the same as the destination trace. The destination trace number is gray on the key, and the underline skips that number when selecting the trace.
Preset	Trace number – 2 (wraps at 1). For example, for Trace 1, the First Trace presets to Trace 5; for Trace 6, it presets to Trace 4.
State Saved	The First Trace operand for each trace is stored in instrument state.
Readback	Trace <trace number>
Initial S/W Revision	Prior to A.02.00

Operand 2

Selects the second trace operand to be used for the trace math functions for the destination trace.

Key Path	Trace/Detector, Math, Trace Operands
Dependencies	The Second Trace cannot be the same as the destination trace. The destination trace number is gray on the key, and the underline skips that number when selecting the trace.
Preset	Trace number – 1 (wraps at 1). For example, for Trace 1, the Second Trace presets to Trace 6; for Trace 6, it presets to Trace 5.
State Saved	The Second Trace operand for each trace is stored in instrument state

Readback	Trace <trace number>
Initial S/W Revision	Prior to A.02.00

Normalize

Displays menu keys that let you normalize trace data.

This key only appears in the Normal View. It does not appear when in the Spectrogram View.

Key Path	Trace/Detector
Readback	[On] or [Off]
Initial S/W Revision	Prior to A.02.00

Normalize On/Off

Normalize (On) activates the normalize function. On each sweep, the normalized trace (Trace 3) is subtracted from Trace 1 and the result is added to the normalized reference level. This arithmetic assumes all values are in decibel units, so we are actually taking a ratio.

This key only appears in the Normal View. It does not appear when in the Spectrogram View.

See [“More Information” on page 1239](#).

See [“Normalize Block Diagram” on page 1241](#).

Key Path	Trace/Detector, Normalize
Remote Command	:CALCulate:NTData[:STATE] OFF ON 0 1 :CALCulate:NTData[:STATE]?
Example	CALC:NTD ON CALC:NTD?
Dependencies	<ul style="list-style-type: none"> If Normalize (On) is pressed before Store Ref (1 3), an error message is generated. Normalize remains off in this case. Normalize is not available (grayed out) if any Trace Math function is on.
Couplings	When Normalize is turned on, Trace 1 is placed in Clear/Write with Update = On and Display = On.
Preset	OFF
State Saved	Saved in Instrument State.
Initial S/W Revision	Prior to A.02.00

More Information

The normalize function is most useful for applying correction data to a trace while making a stimulus-response measurement with a tracking generator (or synchronized source). For example, connect the cables and a through line, in place of the device to be measured, between the tracking

Trace/Detector

generator and the analyzer input. Notice that the frequency response is not perfectly flat, showing the response of the cables, as well as the flatness of both the tracking generator and the analyzer. Now press Store Ref (1 3), Normalize On. Notice that the displayed trace is now flat, or normalized. The position of the normalized trace can now be moved to a different position on the display by changing the normalized reference position. This may be useful if the device to be tested has positive gain, such as an amplifier. Now replace the through line with the device under test, and an accurate measurement of the gain or loss can be made.

The normalize function can also be used to perform a scalar reflection measurement (return loss). In this case a directional coupler or bridge is used to extract the reflected signal. In the simplest reflection measurement a Short is placed at the end of the cable and the result is stored to trace 3 (as before). When Normalize is turned on, the result is the calibrated return loss in dB. For a more accurate calibration, an Open and Short can be used. To do the Open/Short calibration, the Open/Short key at the bottom of the Normalize menu is pressed. This will initiate a guided calibration procedure which captures the reference trace. This is then stored to Trace 3, as before. When Normalize is turned on the corrected return loss is displayed.

Measurement Details

First the following calculation is performed:

$$\text{Trace 1} = (\text{Trace 1D} - \text{Normalized Trace})$$

Where:

- Trace 1D is the measured value of trace 1, as it comes from the SENSE subsystem.
- Normalized Trace is Trace 3, in which you have previously stored a reference trace
- All values are in decibel units.

This Trace 1 contains the values that will be returned from a trace query, or if the marker is placed on the trace.

For example, let's say bucket 1 on Trace 1 is at 0 dBm, and bucket 1 on Trace 3 is at 10 dBm. The resultant bucket is at $0 \text{ dBm} - 10 \text{ dBm} = -10 \text{ dB}$ (just like with a delta marker).

You are also given the ability to define what (dB) value to use for Ref Level, and to define where on the screen the Ref Lvl line will appear using Normalized Reference Position. This flexibility in displaying the result allows a wide range of devices, including amplifiers, to be tested using Normalize.

In the example above, bucket 1 has the value of -10 dB . Let us assume you have set Norm Ref Lvl to 5 dB. Thus bucket 1 will display 1.5 divisions below the Reference Level line (assuming 10 dB per division).

The Reference Level line is normally the top line of the graticule. If Norm Ref Posn is set to 10, this is the case. If it is set to 9, it is the next line down. If it is set to 5, it is the middle line of the graticule. If set to 0 it is the bottom line.

So in the example above, if Norm Ref Posn is set to 9, then bucket 1 will display 2.5 divisions below the top line of the graticule.

None of the manipulations of Norm Ref Posn and Norm Ref Lvl affect the data in the trace.

As Normalize displays a ratio between two traces (a difference, in dB) the Y-Axis Unit while in Normalize is dB in Log Amplitude and dimensionless in Linear. The Y Axis Unit chosen in the Y Axis

Unit menu is unaffected by Normalize. When you leave Normalize the Y Axis Unit returns to the value set in the Y Axis Unit menu. While in Normalize, all amplitude functions, such as Marker Y and the values in other traces, should be always in dB unit, and so should the returned trace query results. In other words, both trace query result and marker Y become independent of the Y Axis Unit chosen in the Y Axis Unit menu when normalize is on.

(In Linear, the equivalent calculation is performed but it yields a dimensionless ratio, so the normalized ref level will be unitless, presetting to 1, just as in Log it presets to 0 dB).

Y Axis annotation is blanked while in Normalize. Any other traces on the display are plotted in dB, where the dB value used is equivalent to the dBm value of the trace. For example, if bucket 1 in trace 2 is at -40 dBm, that bucket is plotted at -40 dB. All traces use Norm Ref Lvl and Norm Ref Posn for positioning on the display. When Normalize exits, the normal Ref Lvl is restored. This normal Ref Level is unaffected by Normalize.

Normalize Block Diagram

A block diagram showing how Normalize works is presented below:

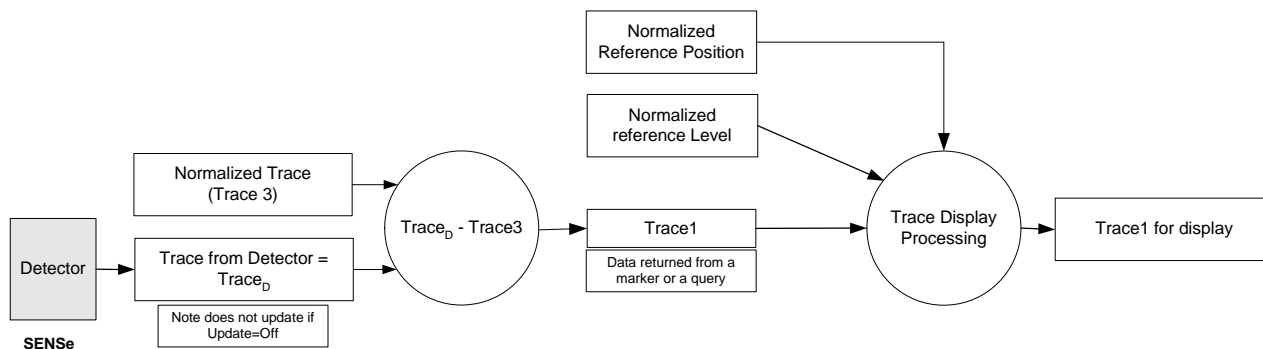

Store Ref (1 -> 3)

Copies trace 1 into trace 3. Store Ref (1 3) must be pressed before pressing Normalize (On). Note that this puts Trace 3 in Update=Off (not updating) and Display=On (visible).

Key Path	Trace/Detector, Normalize
Notes	There is no remote command for this function, however the trace copy command can be used for this purpose.
Dependencies	If Normalize (On) is pressed before Store Ref (1 3), an error message is generated. Normalize remains off in this case.
Initial S/W Revision	Prior to A.02.00

Show Ref Trace (Trace 3)

Views or blanks the reference trace on the display. The reference trace is trace 3, so this is the same as setting Trace 3's "Display" attribute.

Key Path	Trace/Detector, Normalize
----------	---------------------------

Trace/Detector

Example	TRAC3:DISP 1 shows the reference trace.
Notes	Use the TRAC3:DISP command to show or blank the reference trace Trace 3 is always the reference trace by definition.
State Saved	Saved in instrument state.
Initial S/W Revision	Prior to A.02.00

Norm Ref Lvl

Sets the level (in dB) of the normalized reference.

Key Path	Trace/Detector, Normalize
Remote Command	:DISPlay:WINDow[1]:TRACe:Y[:SCALE]:NRLevel <rel_ampl> :DISPlay:WINDow[1]:TRACe:Y[:SCALE]:NRLevel?
Example	DISP:WIND:TRAC:Y:NRL .10 dB DISP:WIND:TRAC:Y:NRL?
Preset	0 dB
State Saved	Saved in instrument state.
Min	-327.6 dB
Max	327.6 dB
Initial S/W Revision	Prior to A.02.00

Norm Ref Posn

Offsets the displayed trace without affecting the instrument gain or attenuation settings. This allows the displayed trace to be moved without decreasing measurement accuracy. The normalized reference position is indicated with a right arrow on the left side of the display and a left arrow on the right side of the display, just inside the graticule. See picture below:

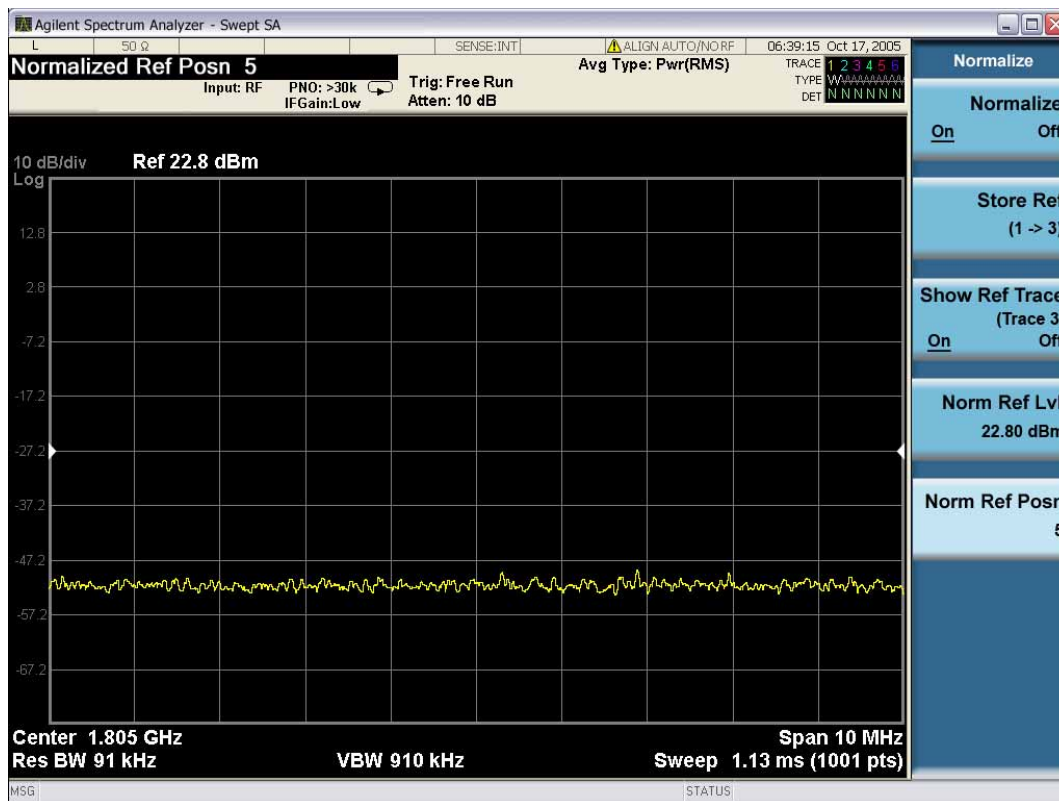

Key Path	Trace/Detector, Normalize
Remote Command	:DISPlay:WINDow[1]:TRACe:Y[:SCALe]:NRPosition <integer> :DISPlay:WINDow[1]:TRACe:Y[:SCALe]:NRPosition?
Example	DISP:WIND:TRAC:Y:NRP 5 DISP:WIND:TRAC:Y:NRP?
Notes	The top and bottom graticule lines correspond to 10 and 0, respectively.
Preset	10
State Saved	Saved in instrument state.
Min	0
Max	10
Initial S/W Revision	Prior to A.2.00

Open/Short Cal

Performs a guided open/short calibration, while providing step-by-step instructions to the user. This is the most accurate way to make the return loss measurement on the X-series analyzers. You are directed through a 1-Port coaxial open calibration, and a 1-Port coaxial short calibration. The result can then be saved to Trace 3. It is used to perform calibrated scalar reflection measurements (return loss), using the

Trace/Detector

Normalize function.

Key Path	Trace/Detector, Normalize
Mode	SA
Notes	does not auto return
Dependencies	Key is grayed out unless Source Mode is Tracking, and control returns to the Normalize menu.
Initial S/W Revision	A.06.01

Open/Short Guided Cal

On pressing the Open/Short Cal softkey in the Normalize menu, the Open Calibration Form is displayed. The form shows a diagrammatic representation of how to connect the external source to the spectrum analyzer to perform the calibration. When the Continue button is pressed, the Open calibration sweep is taken and stored in internal memory, for use later in this cal process. If the Cancel button is pressed, the Open/Short Cal is cancelled and the Normalize menu is returned.

On completion of the Open Calibration, the Short Calibration Form is displayed. This form shows a diagrammatic representation of how to connect the external source to the spectrum analyzer to perform the Short calibration. When the Continue button is pressed, the Short calibration sweep is taken and stored in internal memory, for use later in this cal process. If the Cancel button is pressed, the Open/Short Cal is cancelled and the Normalize menu is returned.

On completion of the Short Calibration, the Open and Short calibration measurements are averaged (power). The picture with prompt is taken off the screen and a menu with “Done Cal” and “Cancel” is displayed. When you press “Done Cal” the resulting trace is stored to Trace 3. If the Cancel button is pressed, the Open/Short Cal is cancelled and the Normalize menu is returned.

The Open Short calibration is applied by taking the average of the Open and the Short trace. The average is a linear average point-by-point. You can further configure averaging on the traces (Open, Short, and final measurement). In this case, the value of the averaged Open and Short trace are linear averaged (by performing a point-by-point average of the two traces). Both the Open and the Short terminations should have approximately unity reflection. Taking the average gives the best estimate of a perfect reflector for a scalar return loss measurement. You should store the result in reference trace 3, for later application with the Normalize function.

Continue

This soft key paces the user through an open/short calibration.

Key Path	Trace/Detector, Normalize, Open/Short Cal
Mode	SA
Notes	does not auto return
Couplings	Key is grayed out unless Source Mode is Tracking, and control returns to the Normalize menu.
Initial S/W Revision	A.06.01

Done Cal

This soft key completes the Open/Short calibration and stores it in trace 3.

Key Path	Trace/Detector, Normalize, Open/Short Cal, Continue, Continue
Mode	SA
Notes	does not auto return
Couplings	Key is grayed out unless Source Mode is Tracking, and control returns to the Normalize menu.
Initial S/W Revision	A.06.01

Cancel

This soft key cancels an open/short calibration.

Key Path	Trace/Detector, Normalize, Open/Short Cal
Mode	SA
Notes	does not auto return
Couplings	Key is grayed out unless Source Mode is Tracking, and control returns to the Normalize menu.
Initial S/W Revision	A.06.01

Copy/Exchange

This menu lets you copy any trace to any other trace, or exchange any trace with any other trace. The action is performed once, it is not an “every sweep” type of thing.

The X-Axis settings and domain of a trace go with it when it is copied or exchanged.

Key Path	Trace/Detector
Remote Command	:TRACe: COPY TRACE1 TRACE2 TRACE3 TRACE4 TRACE5 TRACE6 , TRACE1 TRACE2 TRACE3 TRACE4 TRACE5 TRACE6 :TRACe: COPY?
Example	TRAC: COPY TRACE1, TRACE3 copies Trace 1 to Trace 3 and puts Trace 3 in Update=Off, Display=On
Notes	The TRACe: COPY command is of the form: :TRACe: COPY <source_trace>, <dest_trace>
Notes	In the case of a Copy , the destination trace is put in Update=Off, Display=On after the copy. In the case of an Exchange , both traces are put into Update=Off, Display=On after the exchange.
Preset	TRACE1, TRACE2

Trace/Detector

Initial S/W Revision	Prior to A.02.00
Remote Command	:TRACe:EXCHange TRACE1 TRACE2 TRACE3 TRACE4 TRACE5 TRACE6 , TRACE1 TRACE2 TRACE3 TRACE4 TRACE5 TRACE6 :TRACe:EXCHange?
Example	TRAC:EXCH TRACE1,TRACE2 exchanges Trace 1 and Trace 2 and puts both traces in Update=Off, Display=On .
Notes	The TRACe:EXCHange command is of the form: :TRACe:EXCHange <trace_1>,<trace_2>
Preset	TRACE1, TRACE2
Initial S/W Revision	Prior to A.02.00

From Trace

Selects the trace to be copied to or exchanged with the **To Trace**

Key Path	Trace/Detector, Copy/Exchange
Notes	See "Copy/Exchange".
Preset	1
Initial S/W Revision	Prior to A.02.00

To Trace

Selects the trace to be copied from or exchanged with the **From Trace**

Key Path	Trace/Detector, Copy/Exchange
Notes	See "Copy/Exchange".
Preset	2
Initial S/W Revision	Prior to A.02.00

Copy Now

Executes the Copy operation and puts the destination trace in **Update=Off, Display=On**.

Key Path	Trace/Detector, Copy/Exchange
Notes	See "Copy/Exchange".
Initial S/W Revision	Prior to A.02.00

Exchange Now

Executes the Exchange operation and puts both traces in **Update=Off, Display=On**.

Key Path	Trace/Detector, Copy/Exchange
Notes	See “Copy/Exchange”.
Initial S/W Revision	Prior to A.02.00

Send/Query Trace Data (Remote Command Only)

This command allows trace data to be sent to the analyzer or queried from the analyzer. The response to the query is a list of the amplitude points which comprise the requested trace in the current Y Axis Unit of the analyzer. The X Axis Unit is that of the destination trace (for send) or the source trace (for query).

See “Query Trace Data” on page 1248.

See “More Information” on page 1248.

Remote Command	:TRACe[:DATA] TRACE1 TRACE2 TRACE3 TRACE4 TRACE5 TRACE6, <data>
Notes	The TRACe[:DATA] command is of the form: :TRACe:DATA <trace>,<data> where <trace> can be one of the following parameters: TRACE1,TRACE2,TRACE3,TRACE4,TRACE5,TRACE6 and where <data> can be - ASCII data, which consists of a string of values separated by comma or - REAL or INTeger sent as a definite length block, with a header describing the data to follow.
Couplings	Sweep points will affect the amount of data The FORMat:DATA command describes the different types of data formats that can be used with trace data. Use the FORMat:BORDER command to set the byte order.
Initial S/W Revision	Prior to A.02.00

Query Trace Data

Remote Command	:TRACe [:DATA] ? TRACE1 TRACE2 TRACE3 TRACE4 TRACE5 TRACE6
Example	TRAC TRACE1,-1,-2,-3,-4,-5 sends five points to Trace 1. Assuming that FORMat:DATA is set to ASCII, Y Axis Unit is set to dBm, and sweep points is set to 5, this will result in Trace 1 consisting of the five points -1 dBm, -2 dBm, -3 dBm, -4 dBm, and -5 dBm. TRAC? TRACE2 queries the analyzer for the contents of trace 2.
Initial S/W Revision	Prior to A.02.00

More Information

The format and byte-ordering of the sent or received data will be dependent on the FORMat:DATA and FORMat:BORDER commands. ASCII data consists of a string of comma separated values. REAL or INTeger data is sent as a definite length block, with a header describing the data to follow.

For example, a four point trace might look like this if in ASCII (FORMat:DATA ASCII):

```
-5.87350E+01, -5.89110E+01, -5.87205E+01, -5.12345E+01<NL><END>
```

and like this if in INTeger with 4 bytes per point (FORMat:DATA INT,32):

```
#216<16 bytes of data><NL><END>
```

where the 2 in the #216 means “2 digits of numeric data to follow”, and the 16 is the 2 digits and means “16 binary bytes to follow” (this is the definite length block format).

Note that the data is terminated with <NL><END>. (For GPIB this is newline, or linefeed, followed by EOI set true. For LAN, this is newline only.)

The data format set by FORMat:DATA and FORMat:BORDER is used both for sending data to the instrument and receiving data from the instrument.

When sending data to the instrument, the data block must contain exactly the number of points currently specified in **Sweep, Points** or an error will be generated and there will be no change to the target trace.

No units terminator (for example, dB or V) is used when sending data; the data is taken as being in the current Y Axis Unit of the analyzer.

When a trace is sent to the instrument, it immediately overwrites all of the data in the target trace. Consequently the trace should be inactive in order to achieve predictable results. If you send trace data while a trace is active, and particularly if a sweep or an **Average** or **Max/Min Hold** sequence is already in progress, you may end up with a trace which combines the data you sent with measurement data. Similarly, when querying trace data, it is best if the analyzer is not sweeping during the query.

Therefore, it is generally advisable to be in Single Sweep, or have the trace in View, when sending trace data to the analyzer or querying trace data from the analyzer.

Format Data: Numeric Data (Remote Command Only)

The :FORMat:DATA command is used to tell the analyzer how the data should look on output.

This command works the same way in this and many other measurements, so it is documented in the Common Measurement Functions section.. For details about this key, see [“Format Data: Numeric Data \(Remote Command Only\)”](#) on page 1094.

Format Data: Byte Order (Remote Command Only)

This command works the same way in this and many other measurements, so it is documented in the Common Measurement Functions section.. For details about this key, see [“Format Data: Byte Order \(Remote Command Only\)”](#) on page 1095.

Smooth Trace Data (Remote Command Only)

Not recommended for new designs. Use the CALCulate:DATA:COMPRESS command instead.

Smooths the trace according to the number of points specified in :TRACe:MATH:SMOoth:POINts. There is no equivalent front panel function.

The purpose of this function is to perform a spatial video averaging, as compared to the temporal version supplied by the video-average command [:SENSe]:AVERAge:TYPE VIDEo. The functions of TRACe:MATH:SMOoth <trace> and [:SENSe]:AVERAge:TYPE VIDEo|POWER are not interchangeable.

Remote Command	:TRACe:MATH:SMOoth TRACE1 TRACE2 TRACE3 TRACE4 TRACE5 TRACE6
Initial S/W Revision	Prior to A.02.00

Number of Points for Smoothing (Remote Command Only)

Not recommended for new designs. (Will not be supported in future designs.) Use the CALCulate:DATA:COMPRESS command instead.

Specifies the number of points that will be smoothed. Increasing the number of points increases smoothing at the cost of decreasing resolution. If the number of points is an even number, then the number of points is increased by one. If the number of points is larger than the number of sweep points, then the number of sweep points is used, unless the number of sweep points is even, in which case the number of points will be the sweep points minus one. The number of points smoothed is always an odd number.

Remote Command	:TRACe:MATH:SMOoth:POINts <integer> :TRACe:MATH:SMOoth:POINts?
Example	TRAC:MATH:SMO:POIN 501
Notes	Only odd values allowed; if <integer> even, add 1 unless <integer> = number of sweep points, in which case subtract 1 Used with the TRACe:MATH:SMOoth command.
Preset	11
Min	3

Trace/Detector

Max	Number of sweep points
Initial S/W Revision	Prior to A.02.00

Mean Trace Data (Remote Command Only)

Not recommended for new designs. Use the CALCulate:DATA:COMPRESS command instead.

Returns the mean of the amplitudes of the trace amplitude elements in measurement units.

Remote Command	:TRACe:MATH:MEAN? TRACE1 TRACE2 TRACE3 TRACE4 TRACE5 TRACE6
Example	TRAC:MATH:MEAN? TRACE2
Initial S/W Revision	Prior to A.02.00

Calculate/Compress Trace Data Query (Remote Command Only)

This command works the same way in this and many other measurements, so it is documented in the Common Measurement Functions section.. For details about this key, see [“Calculate/Compress Trace Data Query \(Remote Command Only\)”](#) on page 1087.

Calculate Data Query (Remote Command Only)

This command works the same way in this and many other measurements, so it is documented in the Common Measurement Functions section.. For details about this key, see [“Data Query \(Remote Command Only\)”](#) on page 1087.

Trigger

Accesses a menu of keys to control the selection of the trigger source and the setup of each of the trigger sources. The analyzer is designed to allow triggering from a number of different sources, for example, Free Run, Video, External, RF Burst, and so forth.

The TRIG:SOURCe command (below) will specify the trigger source for the currently selected input (RF or I/Q). If you change inputs, the new input remembers the trigger source it was last programmed to for the current measurement, and uses that trigger source. You can directly set the trigger source for each input using the TRIGger:RF:SOURce and TRIGger:IQ:SOURce commands (later in this section).

Note the inclusion of the <measurement> parameter in the command below. Because each measurement remembers its own Trigger Source, the command must be qualified with the measurement name. Note that for the Swept SA measurement this is not the case; for backwards compatibility, no <measurement> parameter is used when setting the Trigger Source for the Swept SA measurement.

See [“Trigger Source Presets” on page 1253](#)

See [“RF Trigger Source” on page 1256](#)

See [“I/Q Trigger Source” on page 1257](#)

See [“More Information” on page 1258](#)

Key Path	Front-panel key
Remote Command	:TRIGger:<measurement>[:SEQuence]:SOURce EXTErnal1 EXTErnal2 IMMediate LINE FRAME RFBurst VIDeo IF ALARm LAN IQMag IDEMod QDEMod IINPut QINPut AIQMag :TRIGger:<measurement>[:SEQuence]:SOURce?
Example	TRIG:ACP:SOUR EXT1 Selects the external 1 trigger input for the ACP measurement and the selected input TRIG:SOUR VID Selects video triggering for the SANalyzer measurement in the Spectrum Analyzer mode. For SAN, do not use the <measurement> keyword.

Trigger

Notes	<p>Not all measurements have all the trigger sources available to them. Check the trigger source documentation for your specific measurement to see what sources are available.</p> <p>Not all trigger sources are available for each input. See the “RF Trigger Source” on page 1256 and “I/Q Trigger Source” on page 1257 commands for detailed information on which trigger sources are available for each input.</p> <p>Other trigger-related commands are found in the INITiate and ABORt SCPI command subsystems.</p> <p>*OPC should be used after requesting data. This will hold off any subsequent changes to the selected trigger source, until after the sweep is completed and the data is returned.</p> <p>Available ranges and presets can vary from mode to mode.</p>
Dependencies	<p>In some models, there is no second External input. In these models, the External 2 key is blanked and the EXTernal2 parameter will generate a “Hardware missing; Not available for this model number” error.</p>
Preset	<p>See table below</p>
Status Bits/OPC dependencies	<p>The Status Operation Register bit 5 "Waiting for Trigger" is set at the same time as the Sweeping or Measuring bit is set. It is cleared when the trigger actually occurs (that is, after the trigger event occurs and all the applicable trigger criteria have been met). A corresponding pop-up message ("Waiting for trigger") is generated if no trigger signal appears after approximately 2 sec. This message goes away when a trigger signal appears.</p>
Backwards Compatibility SCPI	<p>[:SENSE] : <measurement> : TRIGger : SOURce</p> <p>This backwards compatibility command does not apply to the Swept SA measurement, for that just use :TRIGger:SOURce</p> <p>This backwards compatibility command does not apply to the monitor spectrum, log plot and spot frequency measurements at all.</p> <p>The backwards Compatibility SCPI command, [:SENSE] : ACPr : TRIGger : SOURce, is provided to support the same functionality as [:SENSE] : ACPr : TRIGger : SOURce (PSA W-CDMA, PSA cdma2000 and PSA 1xEVDO) due to the fact that the ACPr node conflicts with the ACPower node.</p> <p>In earlier instruments, the parameter IF was used by apps for the video trigger, so using the IF enum selects video triggering.</p> <p>Sending IF in the command causes VID to be returned to a query.</p>
Initial S/W Revision	<p>Prior to A.02.00</p>
Modified at S/W Revision	<p>A.03.00</p>

Trigger Source Presets

Here are the Trigger Source Presets for the various measurements:

Meas	Mode	Preset for RF	Preset for IQ	Notes
Swept SA	SA	IMM	IQ not supported	
CHP	SA, WCDMA, C2K, WIMAX OFDMA, 1xEVDO, DVB-T/H, DTMB, LTE, LTETDD, CMMB, ISDB-T	IMM	IQ not supported	
OBW	SA, WCDMA, C2K, WIMAX OFDMA, TD-SCDMA, 1xEVDO, LTE, LTETDD, CMMB, ISDB-T	1xEVDO: EXT1 others: IMM	IQ not supported	For 1xEVDO mode, the trigger source is coupled with the gate state, as well as the gate source. When the trigger source changes to RFBurst, External1 or External2, the gate state is set to on, and the gate source is set identically with the trigger source. When the trigger source changes to IMMEDIATE, VIDEO, LINE, FRAME or IF, the gate state is set to off.
CCDF	SA, WCDMA, C2K, WIMAX OFDMA, TD-SCDMA, 1xEV-DO, DVB-T/H, DTMB, LTE, LTETDD, CMMB, ISDB-T	SA, WCDMA, C2K, LTE, DVB-T/H, DTMB, CMMB, ISDB-T: IMMEDIATE WIMAX OFDMA : RFBurst LTETDD: BTS: External 1 MS: Periodic Timer TD-SCDMA: BTS: External 1 MS: RFBurst	TD-SCDMA: BTS: External 1 MS: IQMag LTETDD: BTS: External 1 MS: Periodic Timer Others: IMM	For TD-SCDMA: Trigger source is coupled with radio device. When radio device changes to BTS, trigger source will be changed to EXTERNAL1. When radio device changes to MS, trigger source will be set as RFBurst for RF or IQ Mag for BBIQ. When TriggerSource is RFBurst or IQ Mag, Measure Interval is grayed out.

Trigger

Meas	Mode	Preset for RF	Preset for IQ	Notes
ACP	SA, WCDMA, C2K, WIMAX OFDMA, TD-SCDMA, 1xEVDO, DVB-T/H, DTMB, LTE, LTETDD, CMMB, ISDB-T	IMM	IQ not supported	
Tx Power	SA, GSM, TD-SCDMA	SA, GSM: RFBurst TD-SCDMA: EXternal	IMM	TD-SCDMA doesn't support the Line and Periodic Timer parameters. When the mode is TD-SCDMA, if the Radio Device is switched to BTS, the value will be changed to External 1 and if the Radio device is switched to MS, the value will be changed to RFBurst
SPUR	SA, WCDMA, C2K, WIMAX OFDMA, TD-SCDMA, 1xEVDO, DVB-T/H, LTE, LTETDD	IMM	IQ not supported	
SEM	SA, WCDMA, C2K, WIMAX OFDMA, TD-SCDMA, 1xEVDO, DVB-T/H, DTMB, LTE, LTETDD, CMMB, ISDB-T	SA, WCDMA, C2K, TD-SCDMA, WIMAX OFDMA, LTE, LTETDD, DVB-T/H, DTMB, CMMB, ISDB-T: IMMEDIATE 1xEVDO(BTS): EXTERNAL1	IQ not supported	
CDP	WCDMA	IMM	IMM	
RHO	WCDMA	IMM	IMM	
PCON	WCDMA	IMM	IMM	
QPSK	WCDMA, C2K, 1xEVDO	All except CDMA1xEVDO: IMMEDIATE CDMA1xEVDO: EXT1	IMM	

Meas	Mode	Preset for RF	Preset for IQ	Notes
MON	All except SA and BASIC	IMM	IQ not supported	
WAV		LTETDD: BTS: External 1 MS: Periodic Timer GSM/EDGE: RFBurst All others: IMMediate	LTETDD: BTS: External 1 MS: Periodic Timer GSM/EDGE: IQMag All others: IMMMediate	
PVT	WIMAXOFDMA	RFB	IMM	
EVM	WIMAXOFDMA , DVB-T/H, DTMB, LTE, LTETDD, CMMB, ISDB-T	CMMB: Periodic Timer All others: IMM	CMMB: External 1 All others: IMM	LTE, LTETDD supports Free Run, Video and External 1 only.
SPEC	BASIC	IMM	IMM	
LOG Plot	PN	IMM	IQ not supported	
Spot Freq	PN	IMM	IQ not supported	
GMSK PVT	EDGE/GSM	RFB	IMM	
GMSK PFER	EDGE/GSM	RFB	IQMag	
GMSK ORFS	EDGE/GSM	RFB	IQ not supported	
EDGE PVT	EDGE/GSM	RFB	IMM	
EDGE EVM	EDGE/GSM	RFB	IQMag	
EDGE ORFS	EDGE/GSM	RFB	IQ not supported	
Combine d WCDMA	WCDMA	IMM	IQ not supported	
Combine d GSM	EDGE/GSM	RFB	IQ not supported	

Trigger

Meas	Mode	Preset for RF	Preset for IQ	Notes
List Power Step	WCDMA, EDGE/GSM	IMM	IQ not supported	
Transmit On/Off Power	LTETDD	LTETDD: BTS: External 1 MS: Periodic Timer	LTETDD: BTS: External 1 MS: Periodic Timer	
Transmit Analysis	BLUETOOTH	RFB	IQ not supported	
Adjacent Channel Power	BLUETOOTH	IMM	IQ not supported	
LE In-band Emissions	BLUETOOTH	IMM	IQ not supported	
EDR In-band Spurious Emissions	BLUETOOTH	Periodic Timer	IQ not supported	

RF Trigger Source

The **RF Trigger Source** command selects the trigger to be used for the specified measurement when RF is the selected input. The RF trigger source can be queried and changed even while another input is selected, but it is inactive until RF becomes the selected input.

Note the inclusion of the <measurement> parameter in the command below. Because each measurement remembers its own Trigger Source, the command must be qualified with the measurement name. Note that for the Swept SA measurement this is not the case; for backwards compatibility, no <measurement> parameter is used when setting the Trigger Source for the Swept SA measurement.

Remote Command	<pre>:TRIGger:<measurement>[:SEquence]:RF:SOURce EXTErnal1 EXTErnal2 IMMediate LINE FRAME RFBurst VIDeo IF ALARm LAN :TRIGger:<measurement>[:SEquence]:RF:SOURce?</pre>
Example	<pre>TRIG:ACP:RF:SOUR EXT1</pre> <p>Selects the external 1 trigger input for the ACP measurement and the RF input</p> <pre>TRIG:RF:SOUR VID</pre> <p>Selects video triggering for the SANalyzer measurement and the RF input. For SAN, do not use the <measurement> keyword.</p>

Notes	<p>Not all measurements have all the trigger sources available to them. Check the trigger source documentation for your specific measurement to see what sources are available.</p> <p>Not all trigger sources are available for each input. For the RF Trigger Source, the following trigger sources are available:</p> <ul style="list-style-type: none"> — IMMEDIATE - free run triggering — VIDEO - triggers on the video signal level — LINE - triggers on the power line signal — EXTERNAL1 - triggers on an externally connected trigger source marked "Trigger 1 In" on the rear panel — EXTERNAL2 - triggers on an externally connected trigger source marked "Trigger 2 In" on the front panel. In some models, there is no second External input. In these models, the External 2 key is blanked and the EXTERNAL2 parameter will generate a "Hardware missing; Not available for this model number" error — RFBURST - triggers on the bursted frame — FRAME - triggers on the periodic timer — IF (video) - same as video, for backwards compatibility only — ALARM – LXI Alarm — LAN – LXI LAN event <p>*OPC should be used after requesting data. This will hold off any subsequent changes to the selected trigger source, until after the sweep is completed and the data is returned.</p> <p>Available ranges, and presets can vary from mode to mode.</p>
Status Bits/OPC dependencies	<p>The Status Operation Register bit 5 "Waiting for Trigger" is set at the same time as the Sweeping or Measuring bit is set. It is cleared when the trigger actually occurs (that is, after the trigger event occurs and all the applicable trigger criteria have been met). A corresponding pop-up message ("Waiting for trigger") is generated if no trigger signal appears after approximately 2 sec. This message goes away when a trigger signal appears.</p>
Backwards Compatibility SCPI	<p>In earlier instruments, the parameter IF was used by apps for the video trigger, so using the IF enum selects video triggering.</p> <p>Sending IF in the query returns the VID enum.</p>
Initial S/W Revision	Prior to A.02.00

I/Q Trigger Source

This command selects the trigger to be used for the specified measurement when I/Q (which requires option BBA) is the selected input. The I/Q trigger source can be queried and changed even while another

Trigger

input is selected, but it is inactive until I/Q becomes the selected input.

Remote Command	<pre>:TRIGger:<measurement>[:SEquence]:IQ:SOURce EXTernal1 EXTernal2 IMMediate IQMag IDEMod QDEMod IINPut QINPut AIQMag :TRIGger:<measurement>[:SEquence]:IQ:SOURce?</pre>
Example	<pre>TRIG:WAVEform:SOUR IQM</pre> <p>Selects I/Q magnitude triggering for the IQ Waveform measurement and the I/Q input</p>
Notes	<p>Not all measurements have all the trigger sources available to them. Check the trigger source documentation for your specific measurement to see what sources are available.</p> <p>Not all trigger sources are available for each input. For the I/Q Trigger Source, the following trigger sources are available:</p> <ul style="list-style-type: none"> — IMMEDIATE - free run triggering — EXTernal1 - triggers on an externally connected trigger source on the rear panel — EXTernal2 - triggers on an externally connected trigger source on the front panel — IQMag - triggers on the magnitude of the I/Q signal — IDEMod - triggers on the I/Q signal's demodulated I voltage — QDEMod - triggers on the I/Q signal's demodulated Q voltage — IINPut - triggers on the I channel's ADC voltage — QINPut - triggers on the Q channel's ADC voltage — AIQMag - triggers on the magnitude of the auxiliary receiver channel I/Q signal <p>*OPC should be used after requesting data. This will hold off any subsequent changes to the selected trigger source, until after the sweep is completed and the data is returned.</p> <p>Available ranges, an from mode to mode.d presets can vary</p>
Status Bits/OPC dependencies	<p>The Status Operation Register bit 5 "Waiting for Trigger" is set at the same time as the Sweeping or Measuring bit is set. It is cleared when the trigger actually occurs (that is, after the trigger event occurs and all the applicable trigger criteria have been met). A corresponding pop-up message ("Waiting for trigger") is generated if no trigger signal appears after approximately 2 sec. This message goes away when a trigger signal appears.</p>
Initial S/W Revision	<p>Prior to A.02.00</p>

More Information

The trigger menus let you select the trigger source and trigger settings for a sweep or measurement. In triggered operation (basically, any trigger source other than Free Run), the analyzer will begin a sweep or

measurement only with the selected trigger conditions are met, generally when your trigger source signal meets the specified trigger level and polarity requirements. (In FFT measurements, the trigger controls when the data acquisition begins for FFT conversion.)

For each of the trigger sources, you may define a set of operational parameters or settings which will be applied when that source is selected as the current trigger source. Examples of these settings are Trigger Level, Trigger Delay, and Trigger Slope. You may apply different settings for each source; so, for example, you could have a Trigger Level of 1v for External 1 trigger and -10 dBm for Video trigger.

Once you have established the settings for a given trigger source, they generally will remain unchanged for that trigger source as you go from measurement to measurement within a Mode (although the settings do change as you go from Mode to Mode). Furthermore, the trigger settings within a Mode are the same for the **Trigger** menu, the **Gate Source** menu, and the **Sync Source** menu that is part of the **Periodic Timer Trigger Setup** menu. That is, if **Ext1** trigger level is set to 1v in the **Trigger** menu, it will appear as 1v in both the **Gate Source** and the **Sync Source** menus. For these reasons the trigger settings commands are not qualified with the measurement name, the way the trigger source commands are.

The settings setup menu can be accessed by pressing the key for the current trigger source a second time. For example, one press of Video selects the Video trigger as the source. The Video key becomes highlighted and the hollow arrow on the key turns black. Now a second press of the key takes you into the Video Trigger Setup menu.

Trigger Setup Parameters:

The following examples show trigger setup parameters using an external trigger source.

Example 1 illustrates the trigger conditions with negative slope and no trigger occurs during trigger Holdoff time.

Example 2 illustrates the trigger conditions with positive slope, trigger delay, and auto trigger time.

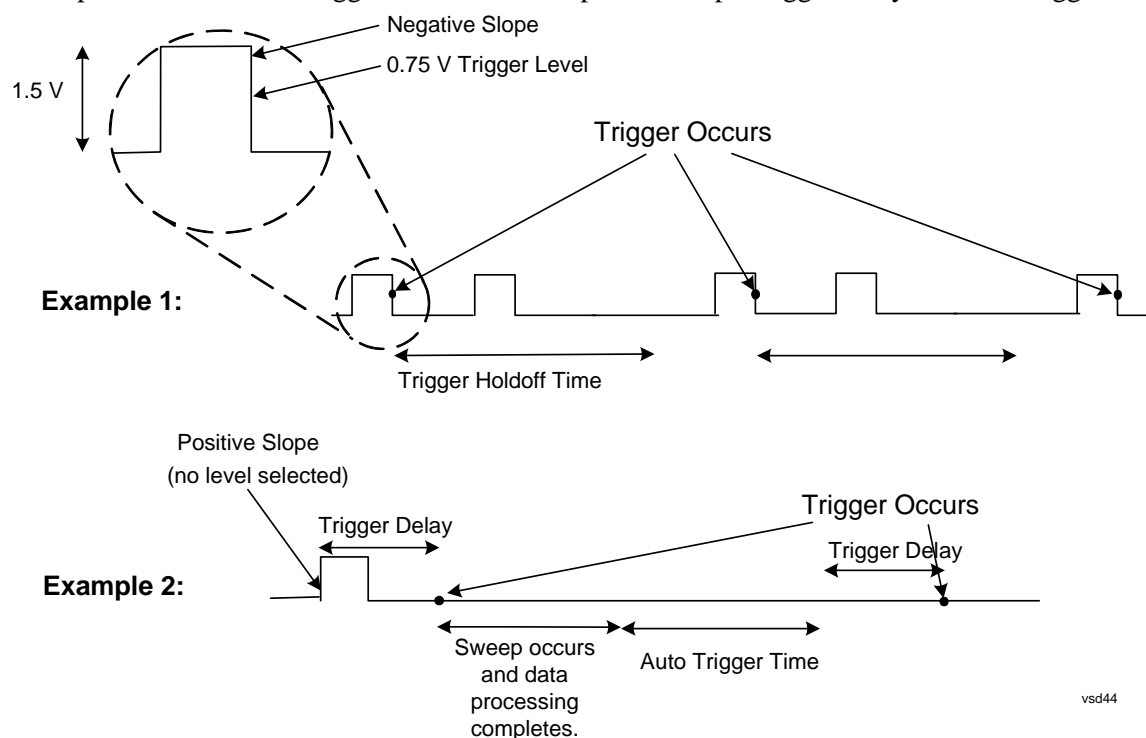

vsd44

Trigger

Free Run

Pressing this key, when it is not selected, selects free-run triggering. Free run triggering occurs immediately after the sweep/measurement is initiated.

Key Path	Trigger
Example	TRIG:SOUR IMM Swept SA measurement TRIG:<meas>:SOUR IMM Measurements other than Swept SA
State Saved	Saved in instrument state
Status Bits/OPC dependencies	The Status Operation Register bit 5 "Waiting for Trigger" is set at the same time as the Sweeping or Measuring bit is set. It is cleared when the trigger actually occurs (that is, after the trigger event occurs and all the applicable trigger criteria have been met). A corresponding pop-up message ("Waiting for trigger") is generated if no trigger signal appears after approximately 2 sec. This message goes away when a trigger signal appears.
Initial S/W Revision	Prior to A.02.00

Video (IF Envelope)

Pressing this key, when it is not selected, selects the video signal as the trigger. The Video trigger condition is met when the video signal (the filtered and detected version of the input signal, including both RBW and VBW filtering) crosses the video trigger level.

NOTE When the detector selected for all active traces is the average detector, the video signal for triggering does not include any VBW filtering.

The video trigger level is shown as a labeled line on the display. The line is displayed as long as video is the selected trigger source.

Pressing this key, when it is already selected, accesses the video trigger setup functions.

Key Path	Trigger
Example	TRIG:SOUR VID Swept SA measurement TRIG:<meas>:SOUR VID Measurements other than Swept SA
Notes	Log Plot and Spot Frequency measurements do not support Video Trigger
Dependencies	Video trigger is allowed in average detector mode.
State Saved	Saved in instrument state
Status Bits/OPC dependencies	The Status Operation Register bit 5 "Waiting for Trigger" is set at the same time as the Sweeping or Measuring bit is set. It is cleared when the trigger actually occurs (that is, after the trigger event occurs and all the applicable trigger criteria have been met). A corresponding pop-up message ("Waiting for trigger") is generated if no trigger signal appears after approximately 2 sec. This message goes away when a trigger signal appears.

Initial S/W Revision	Prior to A.02.00
----------------------	------------------

Trigger Level

Sets a level for the video signal trigger. When the video signal crosses this level, with the chosen slope, the trigger occurs. This level is displayed with a horizontal line only if **Video** is the selected trigger source.

Key Path	Trigger, Video
Remote Command	:TRIGger[:SEquence]:VIDeo:LEVel <ampl> :TRIGger[:SEquence]:VIDeo:LEVel?
Example	TRIG:VID:LEV -40 dBm
Notes	<p>When sweep type = FFT, the video trigger uses the amplitude envelope in a bandwidth wider than the FFT width as a trigger source. This might often be useful, but does not have the same relationship between the displayed trace and the trigger level as in swept triggering.</p> <p>Amplitude Corrections are not taken into account by the Video Trig Level. For example, if you have given yourself effective gain with an amplitude correction factor, the Video Trigger will not fire until you have dropped the trigger line that far below the displayed signal level, rather than simply dropping it down to the displayed signal level.</p> <p>Note that other corrections, specifically External Gain and Ref Level Offset, modify the actual trace data as it is taken and therefore ARE taken into account by Trig Level.</p>
Couplings	This same level is used for the Video trigger source in the Trigger menu and for the Video selection in the Gate Source menu.
Preset	Set the Video Trigger Level -25 dBm on Preset. When the Video Trigger Level becomes the active function, if the value is off screen, set it to either the top or bottom of screen, depending on which direction off screen it was.
State Saved	Saved in instrument state
Min	-170 dBm
Max	+30 dBm
Backwards Compatibility SCPI	:TRIGger[:SEquence]:IF:LEVel :TRIGger[:SEquence]:IF:LEVel?
Backwards Compatibility SCPI	For backward compatibility with VSA/PSA comms apps, we need this alias.
Initial S/W Revision	Prior to A.02.00
Default Unit	depends on the current selected Y axis unit

Trig Slope

Controls the trigger polarity. It is set positive to trigger on a rising edge and negative to trigger on a

Trigger

falling edge.

Key Path	Trigger, Video
Remote Command	:TRIGger[:SEquence]:VIDeo:SLOPe POSitive NEGative :TRIGger[:SEquence]:VIDeo:SLOPe?
Example	TRIG:VID:SLOP NEG
Preset	POSitive
State Saved	Saved in instrument state
Backwards Compatibility SCPI	:TRIGger[:SEquence]:SLOPe :TRIGger[:SEquence]:IF:SLOPe
Backwards Compatibility SCPI	For backward compatibility, the following commands should update all instances of trigger slope (video/external/line). The query returns the trigger slope setting of the selected trigger source. :TRIGger[:SEquence]:SLOPe POSitive NEGative :TRIGger[:SEquence]:SLOPe? For backward compatibility with VSA/PSA comms apps, we need to alias :TRIGger[:SEquence]:IF:SLOPe NEGative POSitive :TRIGger[:SEquence]:IF:SLOPe?
Initial S/W Revision	Prior to A.02.00

Trig Delay

Controls a time delay during that the analyzer will wait to begin a sweep after meeting the trigger criteria. You can use negative delay to pre-trigger the instrument in the time domain or FFT, but not in swept spans.

Key Path	Trigger, Video
Remote Command	:TRIGger[:SEquence]:VIDeo:DELAy <time> :TRIGger[:SEquence]:VIDeo:DELAy? :TRIGger[:SEquence]:VIDeo:DELAy:STATe OFF ON 0 1 :TRIGger[:SEquence]:VIDeo:DELAy:STATe?
Example	TRIG:VID:DEL:STAT ON TRIG:VID:DEL 100 ms
Notes	Video trigger delay may be set to negative values, in time domain, FFT and even swept. It makes intuitive sense in time domain and works well in FFT mode where the bandwidth of the filter before the video trigger is about 1.25 span. In swept spans, negative settings of Trig Delay are treated as a zero setting within the internal hardware and the advisory message "Neg. Trig Delay unavailable in Swept Mode, zero delay used." is generated when such a delay is set.

Preset	Off, 1 us
State Saved	Saved in instrument state
Min	-150 ms
Max	+500 ms
Backwards Compatibility SCPI	:TRIGger[:SEQuence]:IF:DELAy :TRIGger[:SEQuence]:DELAy
Backwards Compatibility SCPI	<p>For backward compatibility with VSA/PSA comms apps, we need to alias Video trigger to</p> <pre>:TRIGger[:SEQuence]:IF:DELAy <time></pre> <pre>:TRIGger[:SEQuence]:IF:DELAy?</pre> <p>For backward compatibility, the following commands should update all instances of trigger delay (not including RF Burst). The query returns the video trigger delay settings of the selected trigger source.</p> <pre>:TRIGger[:SEQuence]:DELAy <time></pre> <pre>:TRIGger[:SEQuence]:DELAy?</pre> <pre>:TRIGger[:SEQuence]:DELAy:STATe OFF ON 0 1</pre> <pre>:TRIGger[:SEQuence]:DELAy:STATe?</pre> <p>Also, the legacy ESA command for trigger offset, TRIGger[:SEQuence]:OFFSet, is supported (see section “Trigger Offset (Remote Command Only)” on page 1311). The offset specified by this commands is remembered by the analyzer and added to the video trigger delay whenever the value is sent to the hardware, when in zero span and in a Res BW \geq 1 kHz.</p>
Initial S/W Revision	Prior to A.02.00
Default Unit	s

Line

Pressing this key, when it is not selected, selects the line signal as the trigger. A new sweep/measurement will start synchronized with the next cycle of the line voltage. Pressing this key, when it is already selected, access the line trigger setup menu.

Key Path	Trigger
Example	TRIG:SOUR LINE Swept SA measurement TRIG:<meas>:SOUR LINE Measurements other than Swept SA
Dependencies	Line trigger is not available when operating from a "dc power source", for example, when the instrument is powered from batteries.
State Saved	Saved in instrument state

Trigger

Status Bits/OPC dependencies	The Status Operation Register bit 5 "Waiting for Trigger" is set at the same time as the Sweeping or Measuring bit is set. It is cleared when the trigger actually occurs (that is, after the trigger event occurs and all the applicable trigger criteria have been met). A corresponding pop-up message ("Waiting for trigger") is generated if no trigger signal appears after approximately 2 sec. This message goes away when a trigger signal appears.
Initial S/W Revision	Prior to A.02.00

Trig Slope

Controls the trigger polarity. It is set positive to trigger on a rising edge and negative to trigger on a falling edge.

Key Path	Trigger, Line
Remote Command	:TRIGger[:SEquence]:LINE:SLOPe POSitive NEGative :TRIGger[:SEquence]:LINE:SLOPe?
Example	TRIG:LINE:SLOP NEG
Preset	POSitive
State Saved	Saved in instrument state
Backwards Compatibility SCPI	:TRIGger[:SEquence]:SLOPe (There are SLOPe backward compatibility commands.)
Initial S/W Revision	Prior to A.02.00

Trig Delay

Controls a time delay during which the analyzer will wait to begin a sweep after meeting the trigger criteria. You can use negative delay to pre-trigger the instrument in time domain or FFT, but not in swept spans.

Key Path	Trigger, Line
Remote Command	:TRIGger[:SEquence]:LINE:DElAY <time> :TRIGger[:SEquence]:LINE:DElAY? :TRIGger[:SEquence]:LINE:DElAY:STATe OFF ON 0 1 :TRIGger[:SEquence]:LINE:DElAY:STATe?
Example	TRIG:LINE:DEL:STAT ON TRIG:LINE:DEL 100 ms

Notes	Video trigger delay may be set to negative values, in time domain, FFT and even swept. It makes intuitive sense in time domain and works well in FFT mode where the bandwidth of the filter before the video trigger is about 1.25 span. In swept spans, negative settings of Trig Delay are treated as a zero setting within the internal hardware and the advisory message "Neg. Trig Delay unavailable in Swept Mode, zero delay used." is generated when such a delay is set.
Preset	Off, 1.000 us
State Saved	Saved in instrument state
Min	-150 ms
Max	500 ms
Backwards Compatibility SCPI	There are DELay backward compatibility commands described in video, Section " Trig Delay " on page 1262) :TRIGger[:SEQuence]:DELay (Also, the legacy ESA command for trigger offset, TRIGger[:SEQuence]:OFFSet, is supported. See section " Trigger Offset (Remote Command Only) " on page 1311. The offset specified by this commands is remembered by the analyzer and added to the line trigger delay whenever the value is sent to the hardware, when in zero span and in a Res BW >= 1 kHz.)
Initial S/W Revision	Prior to A.02.00
Default Unit	S

External 1

Pressing this key, when it is not selected, selects an external input signal as the trigger. A new sweep/measurement will start when the external trigger condition is met using the external 1 input connector on the rear panel.

Pressing this key, when it is already selected, accesses the external 1 trigger setup menu.

Key Path	Trigger
Example	TRIG:SOUR EXT1 Swept SA measurement TRIG:<meas>:SOUR EXT1 Measurements other than Swept SA
Dependencies	Grayed out if in use by Point Trigger in the Source Setup menu. Forced to Free Run if already selected and Point Trigger is set to External 1.
State Saved	Saved in instrument state

Trigger

Status Bits/OPC dependencies	The Status Operation Register bit 5 "Waiting for Trigger" is set at the same time as the Sweeping or Measuring bit is set. It is cleared when the trigger actually occurs (that is, after the trigger event occurs and all the applicable trigger criteria have been met). A corresponding pop-up message ("Waiting for trigger") is generated if no trigger signal appears after approximately 2 sec. This message goes away when a trigger signal appears.
Initial S/W Revision	Prior to A.02.00

Trigger Level

Sets the value where the external 1 trigger input will trigger a new sweep/measurement.

Key Path	Trigger, External 1
Remote Command	:TRIGger[:SEquence]:EXTernal1:LEVel <level> :TRIGger[:SEquence]:EXTernal1:LEVel?
Example	TRIG:EXT1:LEV 0.4 V
Couplings	This same level is used for the Ext1 trigger source in the Trigger menu, for the Ext1 selection in the Periodic Timer sync source (in the Trigger menu and in the Gate Source menu), and also for the Ext1 selection in the Gate Source menu.
Preset	1.2 V
State Saved	Saved in instrument state
Min	-5 V
Max	5 V
Backwards Compatibility SCPI	:TRIGger[:SEquence]:EXTernal:LEVel (For backward compatibility, EXTernal should also work.)
Initial S/W Revision	Prior to A.02.00
Default Unit	V

Trig Slope

Controls the trigger polarity. It is set positive to trigger on a rising edge and negative to trigger on a falling edge.

Key Path	Trigger, External 1
Remote Command	:TRIGger[:SEquence]:EXTernal1:SLOPe POSitive NEGative :TRIGger[:SEquence]:EXTernal1:SLOPe?
Example	TRIG:EXT1:SLOP NEG
Couplings	This same slope is used in the Ext1 selection for the trigger source in the Trigger menu and for the period timer sync source (in the Trigger menu and in the Gate Source menu).

Preset	POSitive
State Saved	Saved in instrument state
Backwards Compatibility SCPI	For backward compatibility, EXTERNAL should also work. Also, there are SLOPe backward compatibility cmds described in Video section “ Trig Slope ” on page 1261 :TRIGger[:SEQUENCE]:SLOPe
Initial S/W Revision	Prior to A.02.00

Trig Delay

Controls a time delay during which the analyzer will wait to begin a sweep after meeting the trigger criteria. You can use negative delay to pre-trigger the instrument in time domain or FFT, but not in swept spans.

Key Path	Trigger, External 1
Remote Command	:TRIGger[:SEQUENCE]:EXTernal1:DElay <time> :TRIGger[:SEQUENCE]:EXTernal1:DElay? :TRIGger[:SEQUENCE]:EXTernal1:DElay:STATe OFF ON 0 1 :TRIGger[:SEQUENCE]:EXTernal1:DElay:STATe?
Example	TRIG:EXT1:DEL:STAT ON TRIG:EXT1:DEL 100 ms
Notes	Video trigger delay may be set to negative values, in time domain, FFT and even swept. It makes intuitive sense in time domain and works well in FFT mode where the bandwidth of the filter before the video trigger is about 1.25 span. In swept spans, negative settings of Trig Delay are treated as a zero setting within the internal hardware and the advisory message "Neg. Trig Delay unavailable in Swept Mode, zero delay used." is generated when such a delay is set.
Preset	Off, 1.000 us
State Saved	Saved in instrument state
Min	-150 ms
Max	+500 ms

Trigger

Backwards Compatibility SCPI	<p>For backward compatibility, EXTERNAL should also work.</p> <p>Also, there are DELAY backward compatibility commands described in video section “Trig Delay ” on page 1262</p> <p>:TRIGGER[:SEQUENCE]:DELAY</p> <p>Also, the legacy ESA command for trigger offset, TRIGGER[:SEQUENCE]:OFFSET, is supported (see section “Trigger Offset (Remote Command Only)” on page 1311). The offset specified by this commands is remembered by the analyzer and added to the external1 trigger delay whenever the value is sent to the hardware, when in zero span and in a Res BW >= 1 kHz.</p>
Initial S/W Revision	Prior to A.02.00
Default Unit	s

External 2

Pressing this key, when it is not selected, selects an external input signal as the trigger. A new sweep/measurement will start when the external trigger condition is met using the external 2 input connector. The external trigger 2 input connector is on the rear panel.

Pressing this key, when it is already selected, accesses the external 2 trigger setup menu.

Key Path	Trigger
Example	<p>TRIG:SOUR EXT2 Swept SA measurement</p> <p>TRIG:<meas>:SOUR EXT2 Measurements other than Swept SA</p>
Dependencies	<p>In some models, there is no second External input. In these models, the External 2 key is blanked and the EXTERNAL2 parameter will generate a “Hardware missing; Not available for this model number” error.</p> <p>Grayed out if in use by Point Trigger in the Source Setup menu.</p> <p>Forced to Free Run if already selected and Point Trigger is set to External 2.</p>
State Saved	Saved in instrument state
Status Bits/OPC dependencies	<p>The Status Operation Register bit 5 "Waiting for Trigger" is set at the same time as the Sweeping or Measuring bit is set. It is cleared when the trigger actually occurs (that is, after the trigger event occurs and all the applicable trigger criteria have been met). A corresponding pop-up message ("Waiting for trigger") is generated if no trigger signal appears after approximately 2 sec. This message goes away when a trigger signal appears.</p>
Initial S/W Revision	Prior to A.02.00
Modified at S/W Revision	A.03.00

Trigger Level

Sets the value where the external 2 trigger input will trigger a new sweep/measurement.

Key Path	Trigger, External 2
Remote Command	:TRIGger[:SEquence]:EXTernal2:LEVel :TRIGger[:SEquence]:EXTernal2:LEVel?
Example	TRIG:EXT2:LEV 1.1 V
Couplings	This same level is used for the Ext2 trigger source in the Trigger menu, for the Ext2 selection in the Periodic Timer sync source (in the Trigger menu and in the Gate Source menu), and also for the Ext2 selection in the Gate Source menu.
Preset	1.2 V
State Saved	Saved in instrument state
Min	-5 V
Max	5 V
Initial S/W Revision	Prior to A.02.00
Default Unit	V

Trig Slope

Controls the trigger polarity. It is set positive to trigger on a rising edge and negative to trigger on a falling edge.

Key Path	Trigger, External 2
Remote Command	:TRIGger[:SEquence]:EXTernal2:SLOPe POSitive NEGative :TRIGger[:SEquence]:EXTernal2:SLOPe?
Example	TRIG:EXT2:SLOP NEG
Couplings	This same slope is used in the Ext2 selection for the trigger source in the Trigger menu and for the period timer sync source (in the Trigger menu and in the Gate Source menu).
Preset	POSitive
State Saved	Saved in instrument state
Backwards Compatibility SCPI	Also, there are SLOPe backward compatibility commands described in Video, section :TRIGger[:SEquence]:SLOPe
Initial S/W Revision	Prior to A.02.00

Trig Delay

Controls a time delay during which the analyzer will wait to begin a sweep after meeting the trigger criteria. You can use negative delay to pre-trigger the instrument in time domain or FFT, but not in swept

Trigger

spans.

Key Path	Trigger, External 2
Remote Command	:TRIGger[:SEquence]:EXternal2:DElay <time> :TRIGger[:SEquence]:EXternal2:DElay? :TRIGger[:SEquence]:EXternal2:DElay:STATe OFF ON 0 1 :TRIGger[:SEquence]:EXternal2:DElay:STATe?
Example	TRIG:EXT2:DEL:STAT ON TRIG:EXT2:DEL 100 ms
Notes	Video trigger delay may be set to negative values, in time domain, FFT and even swept. It makes intuitive sense in time domain and works well in FFT mode where the bandwidth of the filter before the video trigger is about 1.25 span. In swept spans, negative settings of Trig Delay are treated as a zero setting within the internal hardware and the advisory message "Neg. Trig Delay unavailable in Swept Mode, zero delay used." is generated when such a delay is set.
Preset	Off, 1.000 us
State Saved	Saved in instrument state
Min	-150 ms
Max	500 ms
Backwards Compatibility SCPI	Also, there are DELay backward compatibility commands described in video section “Trig Delay ” on page 1262 . :TRIGger[:SEquence]:DElay Also, the legacy ESA command for trigger offset, TRIGger[:SEquence]:OFFSet, is supported (see section “Trigger Offset (Remote Command Only)” on page 1311). The offset specified by this commands is remembered by the analyzer and added to the external2 trigger delay whenever the value is sent to the hardware, when in zero span and in a Res BW >= 1 kHz.
Initial S/W Revision	Prior to A.02.00
Default Unit	s

RF Burst

Pressing this key, when it is not selected, selects the RF Burst as the trigger. A new sweep/measurement will start when an RF burst envelope signal is identified from the signal at the RF Input connector. Pressing this key, when it is already selected, accesses the RF Burst trigger setup menu.

In some models, a variety of burst trigger circuitry is available, resulting in various available burst trigger bandwidths. The analyzer automatically chooses the appropriate trigger path based on the

hardware configuration and other settings of the analyzer.

Key Path	Trigger
Example	TRIG:SOUR RFB Swept SA measurement TRIG:<meas>:SOUR RFB Measurements other than Swept SA
State Saved	Saved in instrument state
Status Bits/OPC dependencies	The Status Operation Register bit 5 "Waiting for Trigger" is set at the same time as the Sweeping or Measuring bit is set. It is cleared when the trigger actually occurs (that is, after the trigger event occurs and all the applicable trigger criteria have been met). A corresponding pop-up message ("Waiting for trigger") is generated if no trigger signal appears after approximately 2 sec. This message goes away when a trigger signal appears.
Initial S/W Revision	Prior to A.02.00
Modified at S/W Revision	A.04.00

Absolute Trigger Level

Sets the absolute trigger level for the RF burst envelope.

Key Path	Trigger, RF Burst
Scope	Meas Global
Remote Command	:TRIGger[:SEquence]:RFBurst:LEVel:ABSolute <ampl> :TRIGger[:SEquence]:RFBurst:LEVel:ABSolute?
Example	TRIG:RFB:LEV:ABS 10 dBm sets the trigger level of the RF burst envelope signal to the absolute level of 10 dBm
Notes	Sending this command does not switch the setting from relative to absolute; to switch it you need to send the :TRIGger[:SEquence]:RFBurst:LEVel:TYPE command, below. Amplitude Corrections are not taken into account by the Absolute Trigger Level. For example, if you have given yourself effective gain with an amplitude correction factor, the Absolute Trigger will not fire until you have set the trigger level that far below the displayed signal level, rather than simply to the displayed signal level. This is only true for Amplitude Corrections, not External Gain or Ref Level Offset functions. If mode is Bluetooth, the default value is -50 dBm.
Couplings	This same level is used for the RF Burst trigger source in the Trigger menu, for the RF Burst selection in the Periodic Timer sync source (in the Trigger menu and in the Gate Source menu), and also for the RF Burst selection in the Gate Source menu
Preset	-20 dBm

Trigger

State Saved	Saved in state
Min	-200 dBm
Max	100 dBm
Initial S/W Revision	Prior to A.02.00
Modified at S/W Revision	A.04.00
Default Unit	depends on the current selected Y-Axis unit

Key Path	Trigger, RF Burst
Remote Command	:TRIGger[:SEquence]:RFBurst:LEVel:TYPE ABSolute RELative :TRIGger[:SEquence]:RFBurst:LEVel:TYPE?
Example	TRIG:RFB:LEV:TYPE REL sets the trigger level type of the RF burst trigger to Relative.
Preset	ABSolute
State Saved	Saved in instrument state
Initial S/W Revision	Prior to A.02.00
Modified at S/W Revision	A.04.00

Relative Trigger Level

Sets the relative trigger level for the RF burst envelope.

In some models, the relative burst trigger function is implemented in hardware. In other models, without the advanced triggering hardware required, the relative burst trigger function is implemented in software in some measurements, and is unavailable in other measurements.

When implemented in software, the relative RF Burst trigger function is implemented as follows:

1. The measurement starts with the absolute RF Burst trigger setting. If it can not get a trigger with that level, auto trigger fires and the acquisition starts anyway. After the acquisition, the measurement searches for the peak in the acquired waveform and saves it.
2. Now, in the next cycle of the measurement, the measurement determines a new absolute RF Burst level based on the peak value from the first measurement and the Relative RF Burst Trigger Level (always 0 or negative dB) set by the user. The following formula is used:

$$\text{absolute RF Burst level} = \text{peak level of the previous acquisition} + \text{relative RF Burst level}$$

3. If the new absolute RF Burst level differs from the previous by more than 0.5 dB, the new level is sent to the hardware; otherwise it is not updated (to avoid slowing down the acquisition)

Steps 2 and 3 repeat for subsequent measurements.

Key Path	Trigger, RF Burst
----------	--------------------------

Scope	Meas Global
Remote Command	:TRIGger[:SEquence]:RFBurst:LEVel:RELative <rel_ampl> :TRIGger[:SEquence]:RFBurst:LEVel:RELative?
Example	TRIG:RFB:LEV:REL -10 dB sets the trigger level of the RF burst envelope signal to the relative level of -10 dB
Notes	Sending this command does not switch the setting from absolute to relative; to switch it you need to send the :TRIGger[:SEquence]:RFBurst:LEVel:TYPE command, above. The relative trigger level is not available in some measurements. In those measurements the RELative parameter, and the :TRIGger[:SEquence]:RFBurst:LEVel:TYPE command (above), should generate an error if sent.
Dependencies	This key is grayed out and Absolute Trigger Level selected if the required hardware is not present in your analyzer and the current measurement does not support Relative triggering.
Preset	-6 dB GSM: -25 dB
State Saved	Saved in instrument state
Min	-45 dB
Max	0 dB
Backwards Compatibility SCPI	:TRIGger[:SEquence]:RFBurst:LEVel Is aliased to: :TRIGger[:SEquence]:RFBurst:LEVel:RELative because the PSA had ONLY relative burst triggering
Initial S/W Revision	Prior to A.02.00
Modified at S/W Revision	A.04.00
Default Unit	dB or dBc

Trigger Slope

It is set positive to trigger on a rising edge and negative to trigger on a falling edge.

Key Path	Trigger, RF Burst
Remote Command	:TRIGger[:SEquence]:RFBurst:SLOPe POSitive NEGative :TRIGger[:SEquence]:RFBurst:SLOPe?
Example	TRIG:RFB:SLOP NEG

Trigger

Couplings	This same slope is used in the RF Burst selection for the trigger source in the Trigger menu and for the period timer sync source (in the Trigger menu and in the Gate Source menu).
Preset	POSitive
State Saved	Saved in instrument state
Backwards Compatibility SCPI	Also, there are SLOPe backward compatibility commands described in Video section “Trig Slope ” on page 1261 :TRIGger[:SEQuence]:SLOPe
Initial S/W Revision	Prior to A.02.00

Trig Delay

Controls a time delay during which the analyzer will wait to begin a sweep after meeting the trigger criteria. You can use negative delay to pre-trigger the instrument in time domain or FFT, but not in swept spans.

Key Path	Trigger, RF Burst
Remote Command	:TRIGger[:SEQuence]:RFBurst:DELay <time> :TRIGger[:SEQuence]:RFBurst:DELay? :TRIGger[:SEQuence]:RFBurst:DELay:STATe OFF ON 0 1 :TRIGger[:SEQuence]:RFBurst:DELay:STATe?
Example	TRIG:RFB:DEL:STAT ON TRIG:RFB:DEL 100 ms
Notes	Video trigger delay may be set to negative values, in time domain, FFT and even swept. It makes intuitive sense in time domain and works well in FFT mode where the bandwidth of the filter before the video trigger is about 1.25 span. In swept spans, negative settings of Trig Delay are treated as a zero setting within the internal hardware and the advisory message "Neg. Trig Delay unavailable in Swept Mode, zero delay used." is generated when such a delay is set.
Preset	Off, 1.000 us
State Saved	Saved in instrument state
Min	-150 ms
Max	500 ms
Backwards Compatibility SCPI	Also, there are DELay backward compatibility commands described in video section “Trig Delay ” on page 1262 . :TRIGger[:SEQuence]:DELay
Initial S/W Revision	Prior to A.02.00
Default Unit	s

Periodic Timer (Frame Trigger)

Pressing this key, when it is not selected, selects the internal periodic timer signal as the trigger. Triggering occurrences are set by the **Period** parameter, which is modified by the **Sync Source** and **Offset**. Pressing this key, when it is already selected, accesses the periodic timer trigger setup functions.

If you do not have a sync source selected (it is Off), then the internal timer will not be synchronized with any external timing events.

Key Path	Trigger
Example	TRIG:SOUR FRAM Swept SA measurement TRIG:<meas>:SOUR FRAM Measurements other than Swept SA
State Saved	Saved in instrument state
Readback	[Sync: <value of Sync Source>], for example, [Sync: External 1]
Status Bits/OPC dependencies	The Status Operation Register bit 5 "Waiting for Trigger" is set at the same time as the Sweeping or Measuring bit is set. It is cleared when the trigger actually occurs (that is, after the trigger event occurs and all the applicable trigger criteria have been met). A corresponding pop-up message ("Waiting for trigger") is generated if no trigger signal appears after approximately 2 sec. This message goes away when a trigger signal appears.
Initial S/W Revision	Prior to A.02.00

Periodic Timer Triggering:

This feature selects the internal periodic timer signal as the trigger. Trigger occurrences are set by the **Periodic Timer** parameter, which is modified by the **Sync Source** and **Offset**.

The figure below shows the action of the periodic timer trigger. Before reviewing the figure, we'll explain some uses for the periodic trigger.

A common application is measuring periodic burst RF signals for which a trigger signal is not easily available. For example, we might be measuring a TDMA radio which bursts every 20 ms. Let's assume that the 20 ms period is very consistent. Let's also assume that we do not have an external trigger source available that is synchronized with the period, and that the signal-to-noise ratio of the signal is not high enough to provide a clean RF burst trigger at all of the analysis frequencies. For example, we might want to measure spurious transmissions at an offset from the carrier that is larger than the bandwidth of the RF burst trigger. In this application, we can set the Periodic Timer to a 20.00 ms period and adjust the offset from that timer to position our trigger just where we want it. If we find that the 20.00 ms is not exactly right, we can adjust the period slightly to minimize the drift between the period timer and the signal to be measured.

A second way to use this feature would be to use **Sync Source** temporarily, instead of **Offset**. In this case, we might tune to the signal in a narrow span and use the RF Burst trigger to synchronize the periodic timer. Then we would turn the sync source off so that it would not mis-trigger. Mis-triggering can occur when we are tuned so far away from the RF burst trigger that it is no longer reliable.

A third example would be to synchronize to a signal that has a reference time element of much longer period than the period of interest. In some CDMA applications, it is useful to look at signals with a short periodicity, by synchronizing that periodicity to the "even-second clock" edge that happens every two

Trigger

seconds. Thus, we could connect the even-second clock trigger to Ext1 and use then Ext1 as the sync source for the periodic timer.

The figure below illustrates this third example. The top trace represents the even-second clock. It causes the periodic timer to synchronize with the leading edge shown. The analyzer trigger occurs at a time delayed by the accumulated offset from the period trigger event. The periodic timer continues to run, and triggers continue to occur, with a periodicity determined by the analyzer time base. The timer output (labeled "late event") will drift away from its ideal time due to imperfect matching between the time base of the signal being measured and the time base of the analyzer, and also because of imperfect setting of the period parameter. But the synchronization is restored on the next even-second clock event.

("Accumulated offset" is described in the in the **Offset** function section.)

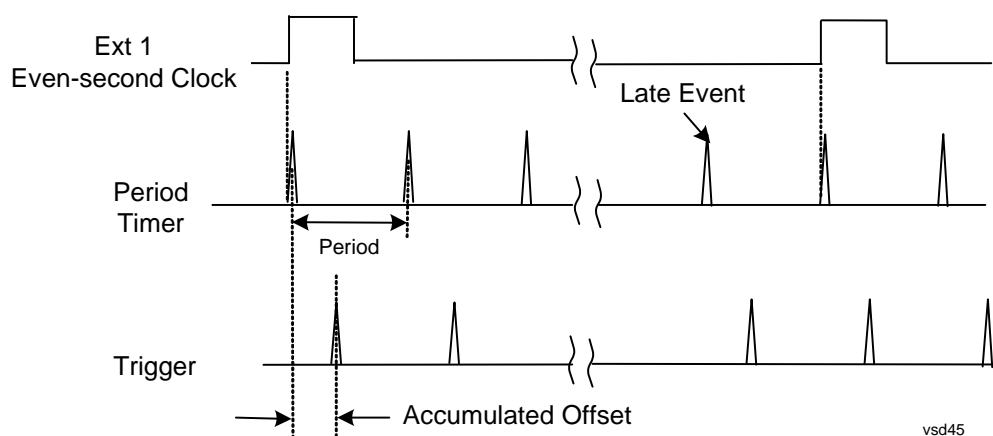

Period

Sets the period of the internal periodic timer clock. For digital communications signals, this is usually set to the frame period of your current input signal. In the case that sync source is not set to OFF, and the external sync source rate is changed for some reason, the periodic timer is synchronized at the every external synchronization pulse by resetting the internal state of the timer circuit.

Key Path	Trigger, Periodic Timer
Remote Command	:TRIGger[:SEquence]:FRAMe:PERiod <time> :TRIGger[:SEquence]:FRAMe:PERiod?
Example	TRIG:FRAM:PER 100 ms
Dependencies	The invalid data indicator turns on when the period is changed, until the next sweep/measurement completes.
Couplings	The same period is used in the Gate Source selection of the period timer.
Preset	20 ms GSM: 4.615383
State Saved	Saved in instrument state
Min	100.000 ns
Max	559.0000 ms

Initial S/W Revision	Prior to A.02.00
Default Unit	S

Offset

Adjusts the accumulated offset between the periodic timer events and the trigger event. Adjusting the accumulated offset is different than setting an offset, and requires explanation.

The periodic timer is usually not synchronized with any external events, so the timing of its output events has no absolute meaning. Since the timing relative to external events (RF signals) is important, you need to be able to adjust (offset) it. However, you have no direct way to see when the periodic timer events occur. All that you can see is the trigger timing. When you want to adjust the trigger timing, you will be changing the internal offset between the periodic timer events and the trigger event. Because the absolute value of that internal offset is unknown, we will just call that the accumulated offset. Whenever the Offset parameter is changed, you are changing that accumulated offset. You can reset the displayed offset using Reset Offset Display. Changing the display does not change the value of the accumulated offset, and you can still make additional changes to accumulated offset.

To avoid ambiguity, we define that an increase in the "offset" parameter, either from the knob or the SCPI adjust command, serves to delay the timing of the trigger event.

Key Path	Trigger, Periodic Timer
Remote Command	:TRIGger[:SEquence]:FRAMe:OFFSet <time> :TRIGger[:SEquence]:FRAMe:OFFSet?
Example	TRIG:FRAM:OFFS 1.2 ms
Notes	<p>The front panel interface (for example, the knob), and this command, adjust the accumulated offset, which is shown on the active function display. However, the actual amount sent to the hardware each time the offset is updated is the delta value, that is, the current accumulated offset value minus the previous accumulated offset value. Note that the accumulated offset value is essentially arbitrary; it represents the accumulated offset from the last time the offset was zeroed (with the Reset Offset Display key).</p> <p>Note that this command does not change the period of the trigger waveform. Note also that Offset is used only when the sync source is set to OFF, otherwise delay is used, see section “Trig Delay” on page 1281.</p> <p>An increase in the "offset" parameter, either from the knob or the SCPI adjust command, serves to delay the timing of the trigger event.</p>
Notes	<p>When the SCPI command is sent the value shown on the key (and the Active Function, if this happens to be the active function) is updated with the new value. However, the actual amount sent to the hardware is the delta value, that is, the current accumulated offset value minus the previous accumulated offset value.</p> <p>The SCPI query simply returns the value currently showing on the key.</p>
Dependencies	The invalid data indicator turns on when the offset is changed, until the next sweep/measurement completes.

Trigger

Couplings	The same offset is used in the Gate Source selection of the period timer.
Preset	0 s
State Saved	Saved in instrument state
Min	-10.000 s
Max	10.000 s
Initial S/W Revision	Prior to A.02.00
Default Unit	S

Offset Adjust (Remote Command Only)

This remote command does not work at all like the related front panel keys. This command lets you advance the phase of the frame trigger by the amount you specify.

It does not change the period of the trigger waveform. If the command is sent multiple times, it advances the phase of the frame trigger an additional amount each time it is sent. Negative numbers are permitted.

Remote Command	:TRIGger[:SEquence]:FRAMe:ADJust <time>
Example	TRIG:FRAM:ADJ 1.2 ms
Notes	Note that Offset is used only when the sync source is set to OFF, otherwise delay is used, see section “Trig Delay” on page 1281 An increase in the "offset" parameter, either from the knob or the SCPI adjust command, serves to delay the timing of the trigger event.
Notes	The front panel interface (for example, the knob) and the :TRIG:FRAM:OFFS command adjust the accumulated offset, which is shown on the active function display. However, the actual amount sent to the hardware is the delta value, that is, the current offset value minus the previous offset value. When the SCPI command is sent the value shown on the key (and the Active Function, if this happens to be the active function) is updated by increasing it (or decreasing it if the value sent is negative) by the amount specified in the SCPI command. This is a "command only" SCPI command, with no query.
Dependencies	The invalid data indicator turns on when the offset is changed, until the next sweep/measurement completes.
Couplings	The same offset is used in the Gate Source selection of the period timer.
Preset	0 s
State Saved	Saved in instrument state
Min	-10.000 s
Max	10.000 s
Initial S/W Revision	Prior to A.02.00

Default Unit	S
--------------	---

Reset Offset Display

Resets the value of the periodic trigger offset display setting to 0.0 seconds. The current displayed trigger location may include an offset value defined with the **Offset** key. Pressing this key redefines the currently displayed trigger location as the new trigger point that is 0.0 s offset. The **Offset** key can then be used to add offset relative to this new timing.

Key Path	Trigger, Periodic Timer
Remote Command	:TRIGger [:SEquence] :FRAMe:OFFSet :DISPlay:RESet
Example	TRIG:FRAM:OFFS:DISP:RES
Initial S/W Revision	Prior to A.02.00

Sync Source

Selects a signal source for you to synchronize your periodic timer trigger to, otherwise you are triggering at some arbitrary location in the frame. Synchronization reduces the precision requirements on the setting of the period.

For convenience you may adjust the level and slope of the selected sync source in a conditional branch setup menu accessed from the Sync Source menu. Note that these settings match those in the **Trigger** and **Gate Source** menus; that is, each trigger source has only one value of level and slope, regardless of which menu it is accessed from.

Key Path	Trigger, Periodic Timer
Remote Command	:TRIGger [:SEquence] :FRAMe:SYNC EXTernal1 EXTernal2 RFBurst OFF :TRIGger [:SEquence] :FRAMe:SYNC?
Example	TRIG:FRAM:SYNC EXT2
Dependencies	In some models, there is no second External input. In these models, the External 2 key is blanked and the EXTernal2 parameter will generate a “Hardware missing; Not available for this model number” error.
Preset	Off GSM/EDGE: RFBurst
State Saved	Saved in instrument state
Readback	The current setting is read back to this key and it is also Readback to the previous Periodic Timer trigger key.
Initial S/W Revision	Prior to A.02.00
Modified at S/W Revision	A.03.00

Trigger

Off

Turns off the sync source for your periodic trigger. With the sync source off, the timing will drift unless the signal source frequency is locked to the analyzer frequency reference.

Key Path	Trigger, Periodic Timer, Sync Source
Example	TRIG:FRAM:SYNC OFF
Readback	Off
Initial S/W Revision	Prior to A.02.00

External 1

Pressing this key, when it is not selected, selects the external input port that you will use for the periodic trigger synchronization. Pressing this key, when it is already selected, accesses the external 1 sync source setup menu.

Key Path	Trigger, Periodic Timer, Sync Source
Example	TRIG:FRAM:SYNC EXT
Couplings	Same as External 1 trigger source.
Readback	External 1
Initial S/W Revision	Prior to A.02.00

Trigger Level

Sets the value where the signal at the external 1 trigger input will synchronize with the periodic timer trigger. This same level is used in the Ext1 trigger source in the Trigger menu. See section [“Trigger Level ” on page 1266](#) for information on this key and the SCPI command.

Trig Slope

Controls the trigger polarity. It is set positive to trigger on a rising edge and negative to trigger on a falling edge. This same value is used in the Ext1 trigger source in the Trigger menu. See section [“Trig Slope ” on page 1266](#) for information on this key and the SCPI command

External 2

Pressing this key, when it is not selected, selects the external input port that you will use for the periodic frame trigger synchronization.

Pressing this key, when it is already selected, accesses the external 2 sync source setup menu.

Key Path	Trigger, Periodic Timer, Sync Source
Example	TRIG:FRAM:SYNC EXT2
Dependencies	In some models, there is no second External input. In these models, the External 2 key is blanked and the EXTernal2 parameter will generate a “Hardware missing; Not available for this model number” error.
Couplings	Same as External 2 trigger source.

Readback	External 2
Initial S/W Revision	Prior to A.02.00
Modified at S/W Revision	A.03.00

Trigger Level

Sets the value where the signal at the external 2 trigger input will synchronize with the periodic timer trigger. This same level is used in the Ext2 trigger source in the Trigger menu. See section “[Trigger Level](#)” on page 1269 for information on this key and the SCPI command.

Trig Slope

Controls the trigger polarity. It is set positive to trigger on a rising edge and negative to trigger on a falling edge. This same value is used in the Ext2 trigger source in the Trigger menu. See section “[Trig Slope](#)” on page 1269 for information on this key and the SCPI command

RF Burst

Pressing the key once selects the RF burst envelope signal to be used for the periodic timer trigger synchronization.

Press the key a second time to access the RF burst sync source setup menu.

Key Path	Trigger, Periodic Timer, Sync Source
Example	TRIG:FRAM:SYNC RFB
Couplings	Same as RF Burst trigger source.
Readback	RF Burst
Initial S/W Revision	Prior to A.02.00

Trigger Level

Sets the trigger level to be used for the RF Burst trigger. This same level is used in the RF Burst trigger source in the Trigger menu. See section “[Absolute Trigger Level](#)” on page 1271 for information on this key and the SCPI command.

Trig Slope

Controls the RF Burst trigger polarity. It is set positive to trigger on a rising edge and negative to trigger on a falling edge. This same value is used in the RF Burst trigger source in the Trigger menu. See section “[Trigger Slope](#)” on page 1273 for information on this key and the SCPI command

Trig Delay

This setting delays the measurement timing relative to the Periodic Timer.

Key Path	Trigger, Periodic Timer
----------	--------------------------------

Trigger

Remote Command	:TRIGger[:SEquence]:FRAMe:DELAy <time> :TRIGger[:SEquence]:FRAMe:DELAy? :TRIGger[:SEquence]:FRAMe:DELAy:STATe OFF ON 0 1 :TRIGger[:SEquence]:FRAMe:DELAy:STATe?
Notes	Note that delay is used when the sync source is not set to OFF. If the sync source is set to OFF, offset is used.
Preset	Off, 1.000 us
State Saved	Saved in instrument state
Min	-150 ms
Max	+500 ms
Initial S/W Revision	Prior to A.02.00
Default Unit	s

Sync Holdoff

Sync Holdoff specifies the duration that the sync source signal must be kept false before the transition to true to be recognized as the sync timing. The periodic timer phase is aligned when the sync source signal becomes true, after the Holdoff time is satisfied.

A holdoff of 2 ms will work with most WiMAX signals, but there may be cases where the burst off duration is less than 1 ms and this value will need to be changed.

Key Path	Trigger, Periodic Timer
Remote Command	:TRIGger[:SEquence]:FRAMe:SYNC:HOLDoff <time> :TRIGger[:SEquence]:FRAMe:SYNC:HOLDoff? :TRIGger[:SEquence]:FRAMe:SYNC:HOLDoff:STATe OFF ON 0 1 :TRIGger[:SEquence]:FRAMe:SYNC:HOLDoff:STATe?
Preset	On, 1.000 ms
State Saved	Saved in instrument state
Min	0 ms
Max	+500 ms
Initial S/W Revision	Prior to A.02.00
Default Unit	s

LXI Trigger

Pressing this key when it is not selected selects the LXI system as the trigger. Pressing the key when it is already selected accesses the LXI trigger type selection menu, where either LAN Event or Alarm can be

chosen. The key is annotated to display which of the two is currently selected.

Key Path	Trigger
Preset	ON
State Saved	Saved in instrument state
Readback	The LXI trigger source that becomes active when this key is selected is displayed. The possible values are "LAN Event" and "Alarm"
Initial S/W Revision	Prior to A.02.00

LAN Event

Pressing this key when it is not selected selects the LAN event system as the LXI trigger. A new sweep/measurement starts when the pre-configured LAN message arrives if the LXI trigger is selected (see "[LXI Trigger](#)" on page 1282). Pressing this key when it is already selected accesses the LAN trigger setup menu.

NOTE Pressing this key causes Enabled LXI Alarm Triggers to be ignored, since the Trigger source is changed to LXI LAN Event.

Key Path	Trigger, LXI Trigger
Example	TRIG:SOUR LAN Swept SA measurement TRIG:<meas>:SOUR LAN Measurements other than Swept SA
Preset	ON
State Saved	Saved in instrument state
Status Bits/OPC dependencies	The Status Operation Register bit 5 "Waiting for Trigger" is set at the same time as the Sweeping or Measuring bit is set. It is cleared when the trigger actually occurs (that is, after the trigger event occurs and all the applicable trigger criteria have been met). A corresponding pop-up message ("Waiting for trigger") is generated if no trigger signal appears after approximately 2 sec. This message goes away when a trigger signal appears.
Initial S/W Revision	Prior to A.02.00

Disable All

Sets the Enable parameter of every member of the LXI LAN Event list to OFF.

Key Path	Trigger, LXI Trigger, LAN Event
Remote Command	:TRIGger [:SEquence] :LXI:LAN:DISable:ALL
Example	:TRIG:LXI:LAN:DIS:ALL

Trigger

Initial S/W Revision	Prior to A.02.00
----------------------	------------------

LAN Event List

After selecting LAN as the trigger source, the user is presented with a list of LXI Trigger LAN Events to be configured. By default, LAN0-LAN7 are available. Using the TRIG:LXI:LAN:ADD and TRIG:LXI:LAN:REM commands, the size of this list can be changed arbitrarily. Pressing a LAN event branches to that event's setup menu.

Key Path	Trigger, LXI Trigger, LAN Event
Remote Command	:TRIGger [:SEquence] :LXI:LAN:LIST?
Example	:TRIG:LXI:LAN:LIST? Returns the complete list of Trigger LAN Events which is, at minimum: "LAN0", "LAN1", "LAN2", "LAN3", "LAN4", "LAN5", "LAN6", "LAN7"
Preset	"LAN0", "LAN1", "LAN2", "LAN3", "LAN4", "LAN5", "LAN6", "LAN7"
State Saved	Saved in instrument state
Readback	Displays the value of the LXI Trigger LAN Event parameter (Enabled Disabled).
Initial S/W Revision	Prior to A.02.00

Detection

Pressing this key accesses the Trigger Detection menu.

Selecting "Rise" causes the instrument to trigger on the receipt of a signal low LAN Event followed by a signal high LAN Event.

Selecting "Fall" caused the instrument to trigger on the receipt of a signal high LAN Event followed by a signal low LAN Event.

Selecting "High" causes the instrument to trigger on every signal high LAN Event.

Selecting "Low" causes the instrument to trigger on every signal low LAN Event.

Key Path	Trigger, LXI Trigger, LAN Event, <lanEvent>
Remote Command	:TRIGger [:SEquence] :LXI:LAN[:SET]:DETection "LANEVENT", HIGH LOW RISE FALL
Example	:TRIG:LXI:LAN:DET "LAN0",HIGH
Notes	If a non existent LAN event is passed in the lanEvent argument, the command is ignored
Preset	HIGH
State Saved	Saved in instrument state
Range	HIGH LOW RISE FALL
Readback	Currently selected detection type

Initial S/W Revision	Prior to A.02.00
Key Path	Trigger, LXI Trigger, LAN Event, <lanEvent>
Remote Command	:TRIGger[:SEquence]:LXI:LAN[:SET]:DETection? "LANEVENT"
Example	:TRIG:LXI:LAN:DET? "LAN0"?
Notes	If a non existent LAN event is passed in the lanEvent argument, the command is ignored
Preset	HIGH
State Saved	Saved in instrument state
Range	HIGH LOW RISE FALL
Readback	Currently selected detection type
Initial S/W Revision	Prior to A.02.00

Delay

Sets the amount of delay that should pass between receiving a LXI Trigger LAN Event Trigger and the trigger action. A Delay of 0.0 s indicates that the instrument will trigger as soon as possible after receiving the proper LXI LAN Event.

Key Path	Trigger, LXI Trigger, LAN Event, <lanEvent>
Remote Command	:TRIGger[:SEquence]:LXI:LAN[:SET]:DELay "LANEVENT", <time>
Example	:TRIG:LXI:LAN:DEL "LAN0",5S
Preset	0.0 s
State Saved	Saved in instrument state
Range	0.0 – 1.7976931348623157 x 10308 (Max Double)
Initial S/W Revision	Prior to A.02.00

Key Path	Trigger, LXI Trigger, LAN Event, <lanEvent>
Remote Command	:TRIGger[:SEquence]:LXI:LAN[:SET]:DELay? "lanEvent"
Example	:TRIG:LXI:LAN:DEL? "LAN0"
Preset	0.0 s
State Saved	Saved in instrument state
Range	0.0 – 1.7976931348623157 x 10308 (Max Double)
Initial S/W Revision	Prior to A.02.00

Trigger

Enabled/Disabled

When the Trigger Source is set to LXI Trigger LAN Event, the instrument triggers upon receiving any event from the LXI Trigger LAN Event List whose Enabled parameter is set to ON.

If the Enabled parameter is set to OFF, the event is ignored.

Key Path	Trigger, LXI Trigger, LAN Event, <lanEvent>
Remote Command	:TRIGger [:SEquence] :LXI:LAN[:SET]:ENABled "LANEVENT", ON OFF 1 0
Example	:TRIG:LXI:LAN:ENAB "LAN0",ON
Preset	OFF
State Saved	Saved in instrument state
Range	OFF ON 0 1
Initial S/W Revision	Prior to A.02.00

Key Path	Trigger, LXI Trigger, LAN Event, <lanEvent>
Remote Command	:TRIGger [:SEquence] :LXI:LAN[:SET]:ENABled? "LANEVENT"
Example	:TRIG:LXI:LAN:ENAB? "LAN0"
Preset	OFF
State Saved	Saved in instrument state
Range	OFF ON 0 1
Initial S/W Revision	Prior to A.02.00

Add (Remote Command Only)

Adds the provided string to the list of possible LAN events to trigger on. As new LAN events are added, keys are generated in the LAN source menu. New key panels are generated as the number of possible LAN events increases past a multiple of six, and the "More" keys are updated to reflect the new number of key panels in the LAN source menu.

Remote Command	:TRIGger [:SEquence] :LXI:LAN:ADD "LANEVENT"
Example	:TRIG:LXI:LAN:ADD "LANEVENT"
Notes	The maximum length of the string is 16 characters. Longer strings are concatenated to 16 characters and added. No event is added if the LAN Event already exists. This command modifies the LXI Trigger LAN Event List Parameter.
State Saved	Saved in instrument state
Range	Uppercase, Lowercase, Numeric, Symbol except for comma or semicolon

Initial S/W Revision	Prior to A.02.00
----------------------	------------------

Remove (Remote Command Only)

Removes the provided string from the list of possible LAN events to trigger on. As LAN events are removed, keys are removed from the LAN source menu. Key panels are removed as the number of possible LAN events decreases past a multiple of six, and the "More" keys are updated to reflect the new number of key panels in the LAN source menu. It is not possible to remove the "LAN0" – "LAN7" events.

Remote Command	:TRIGger [:SEquence] :LXI:LAN:REMove [:EVENT] "LANEVENT"
Example	:TRIG:LXI:LAN:REM "LANEVENT"
Notes	The maximum length of the string is 16 characters. Longer strings are concatenated and the corresponding LAN Event is removed. Nothing happens if the LAN event does not exist. This command modifies the LXI Trigger LAN Event List Parameter.
State Saved	No
Range	Uppercase, Lowercase, Numeric, Symbol except for comma or semicolon
Initial S/W Revision	Prior to A.02.00

Remove All (Remote Command Only)

Clears the list of customer added LAN events that can cause the instrument to trigger. Events LAN0-LAN7 are not affected. As LAN events are removed, keys are removed from the LAN source menu. Key panels are removed as the number of possible LAN events decreases past a multiple of six, and the "More" keys are updated to reflect the new number of key panels in the LAN source menu.

It is not possible to remove the "LAN0" – "LAN7" events.

Remote Command	:TRIGger [:SEquence] :LXI:LAN:REMove:ALL
Example	:TRIG:LXI:LAN:REM:ALL
Notes	This command modifies the LXI Trigger LAN Event List Parameter.
Initial S/W Revision	Prior to A.02.00

Event Filter (Remote Command Only)

Only LXI Trigger LAN Events coming from hosts matching the filter string are processed. There is no front panel access to this command

The syntax for specifying a filter is as follows:

Filter == ([host[:port]] | [ALL[:port]]) [,Filter]

Specifying an empty string means that LXI trigger packets are accepted as a Trigger from any port on any host on the network via either TCP or UDP.

Trigger

Specifying only the port means that any host communicating over that port can send events.

Specifying ALL indicates that UDP multicast packets are accepted if they are directed to the Internet Assigned Numbers Authority (IANA) assigned multicast address on the IANA assigned default port, or the designated port if specified.

Examples:

"192.168.0.1:23"

"agilent.com, soco.agilent.com"

"agilent.com:80, 192.168.0.1"

The TRIGGER:LXI:LAN:FILTER command applies only to trigger events and will have no effect on state events, even when both are tied to the same event name (like "LAN0"). Similarly, the LXI:EVENT:INPUT:LAN:FILTER command applies only to state events and will have no effect on trigger events.

Remote Command	:TRIGGER[:SEQUENCE]:LXI:LAN[:SET]:FILTER "LANEVENT", "filterString" :TRIGGER[:SEQUENCE]:LXI:LAN[:SET]:FILTER?
Example	:TRIG:LXI:LAN:FILT "LAN0","agilent.com" :TRIG:LXI:LAN:FILT?
Notes	The maximum length of the string is 45 characters. Nothing happens if the LAN event does not exist.
Preset	"" (empty string)
State Saved	Saved in instrument state
Range	Uppercase, Lowercase, Numeric, Symbol
Initial S/W Revision	Prior to A.02.00

Count (Remote Command Only)

Returns the number of items in the LXI Trigger LAN Event List.

Remote Command	:TRIGGER[:SEQUENCE]:LXI:LAN:COUNT?
Example	:TRIG:LXI:LAN:COUN?
Initial S/W Revision	Prior to A.02.00

Identifier (Remote Command Only)

Sets the string that is expected to arrive over the LAN for a given Trigger LAN Event to occur. The Identifier is variable to allow for easier system debugging.

Remote Command	:TRIGGER[:SEQUENCE]:LXI:LAN[:SET]:IDENTIFIER "LANEVENT", "identifier" :TRIGGER[:SEQUENCE]:LXI:LAN[:SET]:IDENTIFIER? "LANEVENT"
-----------------------	---

Example	:TRIG:LXI:LAN:IDEN "LAN0","debugstring"
Notes	The maximum length of the string is 16 characters. Nothing happens if the LAN event does not exist. The default value is that the identifier is equivalent to the name of the LAN Event.
State Saved	Saved in instrument state
Range	Uppercase, Lowercase, Numeric, Symbol
Initial S/W Revision	Prior to A.02.00

Configure (Remote Command Only)

Allows the configuration of some of the above parameters from a single SCPI command.

Remote Command	:TRIGger[:SEquence]:LXI:LAN[:SET]:CONFigure "lanEvent", <enable>, <detection>, <delay>, <filter>, <identifier>
Example	:TRIG:LXI:LAN:CONF "LAN0",1,FALL,0.0,"ALL","debugIdentifier"
Initial S/W Revision	Prior to A.02.00

Alarm

Pressing this key when it is not selected selects the alarm system as the LXI trigger. A new sweep/measurement starts when the configured IEEE 1588 time occurs if the LXI trigger is selected as the active trigger (see [“LXI Trigger” on page 1282](#)). Pressing this key when it is already selected accesses the alarm source selection menu.

Key Path	Trigger, LXI Trigger
Example	TRIG:ACP:SOUR ALAR
Preset	ON
State Saved	Saved in instrument state
Status Bits/OPC dependencies	The Status Operation Register bit 5 "Waiting for Trigger" is set at the same time as the Sweeping or Measuring bit is set. It is cleared when the trigger actually occurs (that is, after the trigger event occurs and all the applicable trigger criteria have been met). A corresponding pop-up message ("Waiting for trigger") is generated if no trigger signal appears after approximately 2 sec. This message goes away when a trigger signal appears.
Initial S/W Revision	Prior to A.02.00

Disable All

This key causes all Alarms in the trigger alarm list to go into the disabled state.

Trigger

(Enabled = OFF)

Key Path	Trigger, LXI Trigger, Alarm
Remote Command	:TRIGger [:SEQuence] :LXI:ALARm:DISable:ALL
Example	:TRIG:LXI:ALAR:DIS:ALL
Initial S/W Revision	Prior to A.02.00

Alarm List

After selecting Alarm as the trigger source, the user is presented with a list of possible alarms. Pressing an alarm (for example, "ALARM0") branches to the alarm setup menu.

Key Path	Trigger, LXI Trigger, Alarm
Remote Command	:TRIGger [:SEQuence] :LXI:ALARm:LIST?
Example	:TRIG:LXI:ALAR:LIST? Returns the complete list of Alarm events which is: "ALARM0"
Preset	"ALARM0"
State Saved	Saved in instrument state
Readback	Displays the value of the LXI Trigger Alarm Enabled parameter (Enabled Disabled).
Initial S/W Revision	Prior to A.02.00

Date/Time

Absolute alarm time sets an alarm for one specific time using the date and time of day (for example, 12/14/2007 at 11:45:15.3456). The Date and Time are represented in the instrument's local time. This is the only way to set an alarm from the front panel.

Epoch time is another type of absolute alarm time. A specific time is identified by the number of seconds it occurs after January 1, 1970 00:00:00 in International Atomic Time (TAI). Epoch Time is time zone invariant. Epoch time is only set via remote; see ["Epoch Time Value \(Remote Command Only\)" on page 1293](#).

The date and time the alarm is scheduled to go off is noted on the branch softkey.

NOTE

The Epoch Time Second and Epoch Time Fraction are the ultimate source of alarm information. The Absolute Time and Date may be changed from the front panel without being applied. When querying the Absolute Time and Date parameters from SCPI, if the Absolute Time and Date have not been applied (and therefore do not match the Epoch Time Second and Epoch Time Fraction), the string "(epoch time not set)" is added to the return value.

Key Path	Trigger, LXI Trigger, Alarm, <alarmEvent>
----------	--

Readback	Annotated with the date and time the alarm is scheduled to go off.
Initial S/W Revision	Prior to A.02.00

Key Path	Trigger, LXI Trigger, Alarm, <alarmEvent>,Time
Remote Command	:TRIGger[:SEquence]:LXI:ALARm[:SET]:TIME[:VALue]:ABSolu te "alarmEvent","date","time"
Example	:TRIG:LXI:ALAR:TIME:ABS "ALARM0","2007/4/6", "15:45:02.123456"
Notes	<p>"date" is a representation of the date the alarm should occur in the form of "YYYY/MM/DD" where:</p> <ul style="list-style-type: none"> • YYYY is the four digit representation of year. (for example, 2007) • MM is the two digit representation of month. (for example. 01 to 12) • DD is the two digit representation of day. (for example, 01 to 28, 29, 30, or 31 depending on the month and year) <p>"time" is a representation of the time of day the alarm should occur in the form of "HH:MM:SS.SSSSSS" where:</p> <ul style="list-style-type: none"> • HH is the two digit representation of the hour in 24 hour format • MM is the two digit representation of minute • SS.SSSSSS is a real representing seconds (for example 02.123456)
Preset	Current date at initialization at 00:00:00.000000
State Saved	Saved in instrument state
Initial S/W Revision	Prior to A.02.00

Key Path	Trigger, LXI Trigger, Alarm, <alarmEvent>,Time
Remote Command	:TRIGger[:SEquence]:LXI:ALARm[:SET]:TIME[:VALue]:ABSolu te? "alarmEvent"
Example	:TRIG:LXI:ALAR:TIME:ABS? "ALARM0" This query returns data using the following format "YYYY/MM/DD HH:MM:SS.SSSSSS" If the Absolute time has been changed from the front panel, but has not been applied, the return value is of the form "YYYY/MM/DD HH:MM:SS.SSSSSS (epoch time not set)".

Trigger

Notes	<p><date> is a representation of the date the alarm should occur in the form of YYYY/MM/DD where:</p> <ul style="list-style-type: none"> • YYYY is the four digit representation of year. (for example, 2007) • MM is the two digit representation of month. (for example. 01 to 12) • DD is the two digit representation of day. (for example, 01 to 28, 29, 30, or 31 depending on the month and year) <p><time> is a representation of the time of day the alarm should occur in the form of HH:MM:SS.SSSSSS where:</p> <ul style="list-style-type: none"> • HH is the two digit representation of the hour in 24 hour format • MM is the two digit representation of minute • SS.SSSSSS is a real representing seconds (for example 02.123456)
Preset	Current date at initialization at 00:00:00.000000
State Saved	Saved in instrument state
Initial S/W Revision	Prior to A.02.00

Date

The date the alarm should occur. All absolute alarm time parameters are set using the same SCPI command; however they each have their own front panel control.

When setting alarm values from the front panel, the new alarm time is not registered with the alarm system until the "Set" key is pressed.

Key Path	Trigger, LXI Trigger, Alarm, <alarmEvent>,Time
Preset	Current date
State Saved	Saved in instrument state
Range	current date – 214748/12/31. Values representing a time in the past result in an error.
Initial S/W Revision	Prior to A.02.00

Time

The time of the day, in the instrument's local time (this takes into account time zones and daylight savings time), the alarm should occur. This parameter is based on a 24 hour clock.

All absolute alarm time parameters are set using the same SCPI command; however they each have their own front panel control.

When setting alarm values from the front panel, the new alarm time is not registered with the alarm system until the "Set" key is pressed.

Key Path	Trigger, LXI Trigger, Alarm, <alarmEvent>,Time
----------	---

Notes	Uses a 24 hour clock. Values representing a time in the past result in an error. Only valid time values are accepted. The <second> field accepts a decimal number, and is valid to the microsecond position. The <year>, <month>, <hour>, and <minute> fields all accept integers.
Preset	00:00:00.000000
State Saved	Saved in instrument state
Range	00:00:00.000000 – 23:59:59.999999
Initial S/W Revision	Prior to A.02.00

Apply

Causes the Absolute Alarm Time values to be converted into an Epoch time (see [“Epoch Time Value \(Remote Command Only\)”](#) on page 1293), compared to the current time, and sent to the Alarm Trigger subsystem. This key can only be pressed when the epoch time and the absolute time are out of synch.

Key Path	Trigger, LXI Trigger, Alarm, <alarmEvent>,Time
Notes	Alarm times are settable to microsecond resolution.
Initial S/W Revision	Prior to A.02.00

Epoch Time Value (Remote Command Only)

Sets the LXI Alarm Time. This represents the number of seconds after January 1, 1970 00:00:00, in TAI time, that the alarm should go off.

Remote Command	:TRIGger[:SEquence]:LXI:ALARm[:SET]:TIME[:VALue] "alarmEvent",<seconds>, <fractionalSeconds>
Example	:TRIG:LXI:ALAR:TIME "ALARM0",123456.0 S, 0.123456
Notes	Values representing a time in the past result in an error.
Preset	Seconds: The number of whole seconds between Jan 1, 1970 at 00:00:00 (in TAI time) and the current date at initialization at 00:00:00 (in TAI time) FractionalSeconds: 0
State Saved	Saved in instrument state
Range	Seconds: Epoch time of current date at 00:00:00 (in TAI time) – 253402300800 + number of seconds local time zone offset from UTC FractionalSeconds: 0.0 – 0.999999
Initial S/W Revision	Prior to A.02.00

Remote Command	:TRIGger[:SEquence]:LXI:ALARm[:SET]:TIME[:VALue]?
-----------------------	---

Trigger

Example	:TRIG:LXI:ALAR:TIME?
Notes	Values representing a time in the past result in an error.
Preset	Seconds: The number of whole seconds between Jan 1, 1970 at 00:00:00 (in TAI time) and the current date at initialization at 00:00:00 (in TAI time) FractionalSeconds: 0
State Saved	Saved in instrument state
Range	Seconds: Epoch time of current date at 00:00:00 (in TAI time) – 253402300800 + number of seconds local time zone offset from UTC FractionalSeconds: 0.0 – 0.999999
Initial S/W Revision	Prior to A.02.00

Epoch Time Seconds (Remote Command Only)

Sets the seconds portion of the LXI Alarm time. This represents the number of seconds after January 1, 1970 00:00:00 (in TAI time) that the alarm should go off.

Values must be in the form of whole seconds; decimal values result in an error.

Remote Command	:TRIGger [:SEQuence] :LXI:ALARm [:SET] :TIME:SECOnds "alarmEvent", <seconds>
Example	:TRIG:LXI:ALAR:TIME:SEC "ALARM0",123456.0 S
Notes	Values representing a time in the past result in an error. Values containing a decimal portion result in an error.
Preset	The number of whole seconds between Jan 1, 1970 at 00:00:00 (in TAI time) and the current date at initialization at 00:00:00 (in TAI time)
State Saved	Saved in instrument state
Range	Epoch time of current date at 00:00:00 (in TAI time) – 253402300800 + number of seconds local time zone offset from UTC
Initial S/W Revision	Prior to A.02.00

Remote Command	:TRIGger [:SEQuence] :LXI:ALARm [:SET] :TIME:SECOnds? "alarmEvent "
Example	:TRIG:LXI:ALAR:TIME:SEC "ALARM0"?
Notes	Values representing a time in the past result in an error. Values containing a decimal portion result in an error.
Preset	The number of seconds between Jan 1, 1970 at 00:00:00 (in TAI time) and the current date at initialization at 00:00:00 (in TAI time)
State Saved	Saved in instrument state

Range	Epoch time of current date at 00:00:00 (in TAI time) – 253402300800 + number of seconds local time zone offset from UTC
Initial S/W Revision	Prior to A.02.00

Epoch Time Fraction (Remote Command Only)

Sets the sub-second value of the Epoch time.

Remote Command	:TRIGger[:SEquence]:LXI:ALARm[:SET]:TIME[:VALue]:FRACti on "alarmEvent",<fractionalSeconds>
Example	:TRIG:LXI:ALAR:TIME:FRAC "ALARM0",0.123456 S
Notes	Values representing a time in the past result in an error.
Preset	0
State Saved	Saved in instrument state
Range	0.0 – 0.999999
Initial S/W Revision	Prior to A.02.00

Remote Command	:TRIGger[:SEquence]:LXI:ALARm[:SET]:TIME[:VALue]:FRACti on? "alarmEvent"
Example	:TRIG:LXI:ALAR:TIME:FRAC "ALARM0"?
Notes	Values representing a time in the past result in an error.
Preset	0
State Saved	Saved in instrument state
Min	0.0
Max	0.999999
Initial S/W Revision	Prior to A.02.00

Relative Time (Remote Command Only)

Sets the values of Epoch Time Seconds and Epoch Time Fraction by adding an offset to the time when the command is issued. For example, if the Relative Time command is issued with an argument of 60s, the alarm will occur 1 minute in the future.

Remote Command	:TRIGger[:SEquence]:LXI:ALARm[:SET]:TIME[:VALue]:RELati ve "alarmEvent",<seconds>
Example	:TRIG:LXI:ALAR:TIME:REL "ALARM0",60.0s
Range	0.0 – 1.7976931348623157 x 10308 (Max Double)
Initial S/W Revision	Prior to A.02.00

Trigger

Remote Command	:TRIGger[:SEquence]:LXI:ALARm[:SET]:TIME[:VALue]:RELati ve? "alarmEvent"
Example	:TRIG:LXI:ALAR:TIME:REL "ALARM0"?
Range	0.0 – 1.7976931348623157 x 10308 (Max Double)
Initial S/W Revision	Prior to A.02.00

Period

Sets the amount of time that should elapse between alarms in a repeating alarm trigger.

Key Path	Trigger, LXI Trigger, Alarm, <alarmEvent>
Remote Command	:TRIGger[:SEquence]:LXI:ALARm[:SET]:PERiod "alarmEvent", <seconds>
Example	:TRIG:LXI:ALAR:PER "ALARM0",1.2345 s
Notes	A period of 0.0s effectively causes the trigger to occur only once, since all repetitions are fired simultaneously
Preset	0.0 s
State Saved	Saved in instrument state
Range	0.0 – 1.7976931348623157 x 10308 (Max Double)
Initial S/W Revision	Prior to A.02.00

Key Path	Trigger, LXI Trigger, Alarm, <alarmEvent>
Remote Command	:TRIGger[:SEquence]:LXI:ALARm[:SET]:PERiod? "alarmEvent"
Example	:TRIG:LXI:ALAR:PER "ALARM0"?
Notes	A period of 0.0s effectively causes the trigger to occur only once, since all repetitions are fired simultaneously
Preset	0.0 s
State Saved	Saved in instrument state
Range	0.0 – 1.7976931348623157 x 10308 (Max Double)
Initial S/W Revision	Prior to A.02.00

Repetitions

Sets the number of times a repeating alarm should fire once the initial alarm time has occurred.

Key Path	Trigger, LXI Trigger, Alarm, <alarmEvent>
Remote Command	:TRIGger[:SEquence]:LXI:ALARm[:SET]:REPeat "alarmEvent", <repetitions>

Example	:TRIG:LXI:ALAR:REP "ALARM0",10
Notes	A repetition value of 0 means infinite repetitions (zero is a special case, triggers at the given period indefinitely) A repetition value of 1 means 1 trigger only, not the initial trigger + 1 repeat
Preset	1
State Saved	Saved in instrument state
Range	1 – 2,147,483,647
Initial S/W Revision	Prior to A.02.00

Key Path	Trigger, LXI Trigger, Alarm, <alarmEvent>
Remote Command	:TRIGger [:SEquence] :LXI:ALARm [:SET] :REPeat? "alarmEvent "
Example	:TRIG:LXI:ALAR:REP "ALARM0",10
Preset	1
State Saved	Saved in instrument state
Min	1
Max	2,147,483,647
Initial S/W Revision	Prior to A.02.00

Enabled

If Enabled is set to ON and the trigger source is set to ALARm, this alarm causes the instrument to trigger.

If Enabled is set to OFF, this alarm is ignored

Key Path	Trigger, LXI Trigger, Alarm, <alarmEvent>
Remote Command	:TRIGger [:SEquence] :LXI:ALARm [:SET] :ENABled "alarmEvent ", ON OFF 1 0
Example	:TRIG:LXI:ALAR:ENAB "ALARM0",ON
Preset	OFF
State Saved	Saved in instrument state
Range	1 0
Initial S/W Revision	Prior to A.02.00

Key Path	Trigger, LXI Trigger, Alarm, <alarmEvent>
Remote Command	:TRIGger [:SEquence] :LXI:ALARm [:SET] :ENABled? "alarmEvent "

Trigger

Example	:TRIG:LXI:ALAR:ENAB "ALARM0"?
Preset	OFF
State Saved	Saved in instrument state
Range	1 0
Initial S/W Revision	Prior to A.02.00

Configure (Remote Command Only)

Allows the configuration of some of the above parameters from a single SCPI command.

Remote Command	:TRIGger[:SEquence]:LXI:ALARm[:SET]:CONFigure "alarmEvent", <enable>, <epochSeconds>, <epochFraction>, <period>, <repeat>
Example	:TRIG:LXI:ALAR:CONF "ALARM0",1,1000000.0,0.123456,1.2,3
Initial S/W Revision	Prior to A.02.00

Count (Remote Command Only)

Returns the number of alarms in the LXI Trigger Alarm List.

Remote Command	:TRIGger1 TRIGger[:SEquence]:LXI:ALARm:COUNT?
Example	:TRIG:LXI:ALAR:COUN?
Initial S/W Revision	Prior to A.02.00

Baseband I/Q

Pressing this key when it is not selected selects Baseband I/Q as the trigger. Pressing the key when it is already selected accesses the Baseband I/Q trigger type selection menu. The key is annotated to display which of the Baseband I/Q trigger types is currently selected.

Key Path	Trigger
State Saved	Saved in instrument state
Readback	The Baseband I/Q trigger source that becomes active when this key is selected is displayed. The possible values are "I/Q Mag", "I", "Q", "Input I", "Input Q", and "Aux I/Q Mag".
Initial S/W Revision	Prior to A.02.00

I/Q Mag

Pressing this key, when it is not selected, selects the I/Q magnitude signal as the trigger. The I/Q Magnitude trigger condition is met when the I/Q magnitude crosses the I/Q magnitude trigger level. The

magnitude is measured at the output of the main I/Q digital receiver.

Key Path	Trigger, Baseband I/Q
Example	TRIG:<meas>:SOUR IQM
Readback Text	I/Q Mag
Initial S/W Revision	Prior to A.02.00

Trigger Level

Sets a level for the I/Q magnitude trigger. When the signal crosses this level, with the chosen slope, the trigger occurs. If the specific Measurement displays the signal from the chosen sampling point a green line will be displayed to indicate the trigger level.

Key Path	Trigger, Baseband I/Q, I/Q Mag
Remote Command	:TRIGger[:SEquence]:IQMag:LEVEl <ampl > :TRIGger[:SEquence]:IQMag:LEVEl?
Example	TRIG:IQM:LEV -30 dBm
Notes	The I/Q reference impedance is used for converting between power and voltage.
Preset	-25 dBm
State Saved	Saved in instrument state
Range	-200 dBm to 100 dBm
Readback Text	<level> dBm
Initial S/W Revision	Prior to A.02.00

Trig Slope

Controls the trigger polarity. It is set positive to trigger on a rising edge and negative to trigger on a falling edge.

Key Path	Trigger, Baseband I/Q, I/Q Mag
Remote Command	:TRIGger[:SEquence]:IQMag:SLOPe POSitive NEGative :TRIGger[:SEquence]:IQMag:SLOPe?
Example	TRIG:IQM:SLOP POS
Preset	POSitive
State Saved	Saved in instrument state
Initial S/W Revision	Prior to A.02.00

Trigger

Trig Delay

Controls a time delay during which the analyzer will wait to begin a sweep after meeting the trigger criteria. You can use negative delay to pre-trigger the instrument in time domain or FFT.

Key Path	Trigger, Baseband I/Q, I/Q Mag
Remote Command	:TRIGger[:SEquence]:IQMag:DELay <time> :TRIGger[:SEquence]:IQMag:DELay? :TRIGger[:SEquence]:IQMag:DELay:STATe OFF ON 0 1 :TRIGger[:SEquence]:IQMag:DELay:STATe?
Example	TRIG:IQM:DEL 10 ms TRIG:IQM:DEL:STAT ON
Preset	1 us OFF
State Saved	Saved in instrument state
Range	-2.5 s to +10 s
Initial S/W Revision	Prior to A.02.00

I (Demodulated)

Pressing this key, when it is not selected, selects the main receiver's output I voltage as the trigger. The I (Demodulated) trigger condition is met when the I voltage crosses the I voltage trigger level.

Key Path	Trigger, Baseband I/Q
Example	TRIG:<meas>:SOUR IDEM
Readback Text	I
Initial S/W Revision	Prior to A.02.00

Trigger Level

Sets a level for the I (Demodulated) trigger. When the signal crosses this level, with the chosen slope, the trigger occurs. If the specific Measurement displays the signal from the chosen sampling point a green line will be displayed to indicate the trigger level.

Key Path	Trigger, Baseband I/Q, I (Demodulated)
Remote Command	:TRIGger[:SEquence]:IDEMod:LEVel <voltage> :TRIGger[:SEquence]:IDEMod:LEVel?
Example	TRIG:IDEM:LEV 0.5 V
Preset	0.25 V
State Saved	Saved in instrument state

Range	-1 to 1 V
Readback Text	0.1 of displayed unit (V, mV, etc.)
Initial S/W Revision	Prior to A.02.00

Trig Slope

Controls the trigger polarity. It is set positive to trigger on a rising edge and negative to trigger on a falling edge.

Key Path	Trigger, Baseband I/Q, I (Demodulated)
Remote Command	:TRIGger[:SEquence]:IDEMod:SLOPe POSitive NEGative :TRIGger[:SEquence]:IDEMod:SLOPe?
Example	TRIG:IDEM:SLOP POS
Preset	POSitive
State Saved	Saved in instrument state
Initial S/W Revision	Prior to A.02.00

Trig Delay

Controls a time delay during which the analyzer will wait to begin a sweep after meeting the trigger criteria. You can use negative delay to pre-trigger the instrument in time domain or FFT.

Key Path	Trigger, Baseband I/Q, I (Demodulated)
Remote Command	:TRIGger[:SEquence]:IDEMod:DELay <time> :TRIGger[:SEquence]:IDEMod:DELay? :TRIGger[:SEquence]:IDEMod:DELay:STATe OFF ON 0 1 :TRIGger[:SEquence]:IDEMod:DELay:STATe?
Example	TRIG:IDEM:DEL 10 ms TRIG:IDEM:DEL:STAT ON
Preset	1 us OFF
State Saved	Saved in instrument state
Range	-2.5 s to +10 s
Initial S/W Revision	Prior to A.02.00

Q (Demodulated)

Pressing this key, when it is not selected, selects the main receiver's output Q voltage as the trigger. The

Trigger

Q (Demodulated) trigger condition is met when the Q voltage crosses the Q voltage trigger level.

Key Path	Trigger, Baseband I/Q
Example	TRIG:<meas>:SOUR QDEM
Readback Text	Q
Initial S/W Revision	Prior to A.02.00

Trigger Level

Sets a level for the Q (Demodulated) trigger. When the signal crosses this level, with the chosen slope, the trigger occurs. If the specific Measurement displays the signal from the chosen sampling point a green line will be displayed to indicate the trigger level.

Key Path	Trigger, Baseband I/Q, Q (Demodulated)
Remote Command	:TRIGger[:SEquence]:QDEMod:LEVel <voltage> :TRIGger[:SEquence]:QDEMod:LEVel?
Example	TRIG:QDEM:LEV 0.5 V
Preset	0.25 V
State Saved	Saved in instrument state
Range	-1 to 1 V
Readback Text	0.1 of displayed unit (V, mV, etc.)
Initial S/W Revision	Prior to A.02.00

Trig Slope

Controls the trigger polarity. It is set positive to trigger on a rising edge and negative to trigger on a falling edge.

Key Path	Trigger, Baseband I/Q, Q (Demodulated)
Remote Command	:TRIGger[:SEquence]:QDEMod:SLOPe POSitive NEGative :TRIGger[:SEquence]:QDEMod:SLOPe?
Example	TRIG:QDEM:SLOP POS
Preset	POSitive
State Saved	Saved in instrument state
Initial S/W Revision	Prior to A.02.00

Trig Delay

Controls a time delay during which the analyzer will wait to begin a sweep after meeting the trigger

criteria. You can use negative delay to pre-trigger the instrument in time domain or FFT.

Key Path	Trigger, Baseband I/Q, Q (Demodulated)
Remote Command	:TRIGger[:SEquence]:QDEMod:DELay <time> :TRIGger[:SEquence]:QDEMod:DELay? :TRIGger[:SEquence]:QDEMod:DELay:STATe OFF ON 0 1 :TRIGger[:SEquence]:QDEMod:DELay:STATe?
Example	TRIG:QDEM:DEL 10 ms TRIG:QDEM:DEL:STAT ON
Preset	1 us OFF
State Saved	Saved in instrument state
Range	-2.5 s to +10 s
Initial S/W Revision	Prior to A.02.00

Input I

Pressing this key, when it is not selected, selects the I channel's ADC voltage as the trigger. The Input I trigger condition is met when the voltage crosses the trigger level.

Key Path	Trigger, Baseband I/Q
Example	TRIG:<meas>:SOUR IINP
Readback Text	Input I
Initial S/W Revision	Prior to A.02.00

Trigger Level

Sets a level for the Input I trigger. When the signal crosses this level, with the chosen slope, the trigger occurs.

Key Path	Trigger, Baseband I/Q, Input I
Remote Command	:TRIGger[:SEquence]:IINPut:LEVel <voltage> :TRIGger[:SEquence]:IINPut:LEVel?
Example	TRIG:IINP:LEV 0.5 V
Preset	0.25 V
State Saved	Saved in instrument state
Range	-1 to 1 V
Readback Text	0.1 of displayed unit (V, mV, etc.)

Trigger

Initial S/W Revision	Prior to A.02.00
----------------------	------------------

Trig Slope

Controls the trigger polarity. It is set positive to trigger on a rising edge and negative to trigger on a falling edge.

Key Path	Trigger, Baseband I/Q, Input I
Remote Command	:TRIGger[:SEquence]:IINPut:SLOPe POSitive NEGative :TRIGger[:SEquence]:IINPut:SLOPe?
Example	TRIG:IINP:SLOP POS
Preset	POSitive
State Saved	Saved in instrument state
Initial S/W Revision	Prior to A.02.00

Trig Delay

Controls a time delay during which the analyzer will wait to begin a sweep after meeting the trigger criteria. You can use negative delay to pre-trigger the instrument in time domain or FFT.

Key Path	Trigger, Baseband I/Q, Input I
Remote Command	:TRIGger[:SEquence]:IINPut:DELay <time> :TRIGger[:SEquence]:IINPut:DELay? :TRIGger[:SEquence]:IINPut:DELay:STATe OFF ON 0 1 :TRIGger[:SEquence]:IINPut:DELay:STATe?
Example	TRIG:IINP:DEL 10 ms TRIG:IINP:DEL:STAT ON
Preset	1 us OFF
State Saved	Saved in instrument state
Range	-2.5 s to +10 s
Initial S/W Revision	Prior to A.02.00

Input Q

Pressing this key, when it is not selected, selects the Q channel's ADC voltage as the trigger. The Input Q trigger condition is met when the voltage crosses the trigger level.

Key Path	Trigger, Baseband I/Q
Example	TRIG:<meas>:SOUR QINP

Readback Text	Input Q
Initial S/W Revision	Prior to A.02.00

Trigger Level

Sets a level for the Input Q trigger. When the signal crosses this level, with the chosen slope, the trigger occurs.

Key Path	Trigger, Baseband I/Q, Input Q
Remote Command	:TRIGger[:SEquence]:QINPut:LEVel <voltage> :TRIGger[:SEquence]:QINPut:LEVel?
Example	TRIG:QINP:LEV 0.5 V
Preset	0.25 V
State Saved	Saved in instrument state
Range	-1 to 1 V
Readback Text	0.1 of displayed unit (V, mV, etc.)
Initial S/W Revision	Prior to A.02.00

Trig Slope

Controls the trigger polarity. It is set positive to trigger on a rising edge and negative to trigger on a falling edge.

Key Path	Trigger, Baseband I/Q, Input Q
Remote Command	:TRIGger[:SEquence]:QINPut:SLOPe POSitive NEGative :TRIGger[:SEquence]:QINPut:SLOPe?
Example	TRIG:QINP:SLOP POS
Preset	POSitive
State Saved	Saved in instrument state
Initial S/W Revision	Prior to A.02.00

Trig Delay

Controls a time delay during which the analyzer will wait to begin a sweep after meeting the trigger criteria. You can use negative delay to pre-trigger the instrument in time domain or FFT.

Key Path	Trigger, Baseband I/Q, Input Q
----------	---------------------------------------

Trigger

Remote Command	:TRIGger[:SEquence]:QINPut:DELay <time> :TRIGger[:SEquence]:QINPut:DELay? :TRIGger[:SEquence]:QINPut:DELay:STATE OFF ON 0 1 :TRIGger[:SEquence]:QINPut:DELay:STATE?
Example	TRIG:QINP:DEL 10 ms TRIG:QINP:DEL:STAT ON
Preset	1 us OFF
State Saved	Saved in instrument state
Range	-2.5 s to +10 s
Initial S/W Revision	Prior to A.02.00

Auxiliary Channel I/Q Mag

Pressing this key, when it is not selected, selects the Auxiliary Channel I/Q magnitude signal as the trigger. The Auxiliary Channel I/Q Magnitude trigger condition is met when the auxiliary receiver's I/Q magnitude output crosses the Auxiliary I/Q magnitude trigger level.

Key Path	Trigger, Baseband I/Q
Example	TRIG:<meas>:SOUR AIQM
Readback Text	Aux I/Q Mag
Initial S/W Revision	Prior to A.02.00

Trigger Level

Sets a level for the I/Q magnitude trigger. When the signal crosses this level, with the chosen slope, the trigger occurs.

Key Path	Trigger, Baseband I/Q, Aux Channel I/Q Mag
Remote Command	:TRIGger[:SEquence]:AIQMag:LEVel <ampl > :TRIGger[:SEquence]:AIQMag:LEVel?
Example	TRIG:AIQM:LEV -30 dBm
Notes	The I/Q reference impedance is used for converting between power and voltage.
Preset	-25 dBm
State Saved	Saved in instrument state
Range	-200 dBm to 100 dBm
Readback Text	<level> dBm

Initial S/W Revision	Prior to A.02.00
----------------------	------------------

Trig Slope

Controls the trigger polarity. It is set positive to trigger on a rising edge and negative to trigger on a falling edge.

Key Path	Trigger, Baseband I/Q, Aux Channel I/Q Mag
Remote Command	:TRIGger[:SEquence]:AIQMag:SLOPe POSitive NEGative :TRIGger[:SEquence]:AIQMag:SLOPe?
Example	TRIG:AIQM:SLOP POS
Preset	POSitive
State Saved	Saved in instrument state
Initial S/W Revision	Prior to A.02.00

Trig Delay

Controls a time delay during which the analyzer will wait to begin a sweep after meeting the trigger criteria. You can use negative delay to pre-trigger the instrument in time domain or FFT.

Key Path	Trigger, Baseband I/Q, Aux Channel I/Q Mag
Remote Command	:TRIGger[:SEquence]:AIQMag:DELay <time> :TRIGger[:SEquence]:AIQMag:DELay? :TRIGger[:SEquence]:AIQMag:DELay:STATe OFF ON 0 1 :TRIGger[:SEquence]:AIQMag:DELay:STATe?
Example	TRIG:AIQM:DEL 10 ms TRIG:AIQM:DEL:STAT ON
Preset	1 us OFF
State Saved	Saved in instrument state
Range	-2.5 s to +10 s
Initial S/W Revision	Prior to A.02.00

Trigger Center Frequency

This key sets the center frequency to be used by the auxiliary receiver.

Key Path	Trigger, Baseband I/Q, Aux Channel I/Q Mag
Remote Command	:TRIGger[:SEquence]:AIQMag:CENTer <freq> :TRIGger[:SEquence]:AIQMag:CENTer?

Trigger

Example	:TRIG:AIQM:CENT 10 MHz
Notes	Trigger CF + 1/2 Trigger BW < Max Trigger CF – 1/2 Trigger BW > Min
Preset	0 Hz
State Saved	Saved in instrument state
Range	–40 MHz to 40 MHz
Initial S/W Revision	Prior to A.02.00

Trigger Bandwidth

This key sets the information bandwidth used by the auxiliary receiver for the Auxiliary Channel I/Q Magnitude trigger.

Key Path	Trigger, Baseband I/Q, Aux Channel I/Q Mag
Remote Command	:TRIGger[:SEquence]:AIQMag:BANDwidth <freq> :TRIGger[:SEquence]:AIQMag:BANDwidth?
Example	:TRIG:AIQM:BAND 8 MHz
Notes	The combined sample rate for the main and auxiliary receivers cannot exceed 100 MSa/sec. The bandwidth available to the Trigger BW is limited to what is available after the main receiver's bandwidth (Info BW, sometimes pre-FFT BW) is set. Because of this limitation, the Max is not always achievable. The combination of Trigger Center Freq and Trigger BW is also limited: Trigger CF + 1/2 Trigger BW < Max Trigger CF – 1/2 Trigger BW > Min
Preset	Bandwidth option dependent: No Opt: 10 MHz Opt B25: 25 MHz Opt S40: 40 MHz
State Saved	Saved in instrument state
Range	10 Hz to Maximum
Initial S/W Revision	Prior to A.02.00

Auto/Holdoff

Opens up a menu that lets you adjust Auto Trigger and Trigger Holdoff parameters

Key Path	Trigger
----------	----------------

Readback line	<p>Displays a summary of the Auto Trig and Holdoff settings, in square brackets</p> <p>First line: Auto Off or Auto On</p> <p>Second Line: "Hldf" followed by:</p> <ul style="list-style-type: none"> • If Holdoff is Off, readback Off • If Holdoff On and Type = Normal, readback value • If Holdoff On and Type = Above, readback value followed by AL • If Holdoff On and Type = Below, readback value followed by BL • If Holdoff Type selection is not supported by the current measurement, Holdoff Type is always Normal
Initial S/W Revision	A.02.00

Auto Trig

Sets the time that the analyzer will wait for the trigger conditions to be met. If they are not met after that much time, then the analyzer is triggered anyway.

Key Path	Trigger, Auto/Holdoff
Remote Command	<pre>:TRIGger[:SEquence]:ATRigger <time> :TRIGger[:SEquence]:ATRigger? :TRIGger[:SEquence]:ATRigger:STATe OFF ON 0 1 :TRIGger[:SEquence]:ATRigger:STATe?</pre>
Example	<pre>TRIG:ATR:STAT ON TRIG:ATR 100 ms</pre>
Notes	The "time that the analyzer will wait" starts when the analyzer is ready for a trigger, which may be hundreds of ms after the data acquisition for a sweep is done. The "time" ends when the trigger condition is satisfied, not when the delay ends.
Preset	Off, 100 ms
State Saved	Saved in instrument state
Min	1 ms
Max	100 s
Initial S/W Revision	Prior to A.02.00
Default Unit	s

Trig Holdoff

Sets the holdoff time between triggers. When the trigger condition is satisfied, the trigger occurs, the delay begins, and the holdoff time begins. New trigger conditions will be ignored until the holdoff time

Trigger

expires. For a free-running trigger, the holdoff value is the minimum time between triggers.

Key Path	Trigger, Auto/Holdoff
Remote Command	:TRIGger[:SEQuence]:HOLDoff <time> :TRIGger[:SEQuence]:HOLDoff? :TRIGger[:SEQuence]:HOLDoff:STATe OFF ON 0 1 :TRIGger[:SEQuence]:HOLDoff:STATe?
Example	TRIG:HOLD:STAT ON TRIG:HOLD 100 ms
Preset	Off, 100 ms
State Saved	Saved in instrument state
Min	0 s
Max	0.5 s
Initial S/W Revision	Prior to A.02.00
Default Unit	s

Holdoff Type

Lets you set the Trigger Holdoff Type.

NOTE	Holdoff Type is not supported by all measurements. If the current measurement does not support it, this key will be blank and the Holdoff Type will be Normal. If the Holdoff Type SCPI is sent while in such a measurement, the SCPI will be accepted and the setting remembered, but it will have no effect until a measurement is in force that supports Holdoff Type.
-------------	---

Trigger Holdoff Type functionality:

- **NORMal**
This is the “oscilloscope” type of trigger holdoff, and is the setting when the Holdoff Type key does not appear. In this type of holdoff, no new trigger will be accepted until the holdoff interval has expired after the previous trigger.
- **ABOVe**
If the trigger slope is positive, a trigger event is generated only if the signal characteristic of interest crosses the trigger threshold (with positive slope) and then remains above the threshold for at least the holdoff time. For negative slope, the trigger event is generated if the signal characteristic crosses the threshold (with negative slope) after having been above the threshold for at least the holdoff time. In either case, the trigger event is associated with the time the level was crossed.
- **BELow**
If the trigger slope is positive, a trigger event is generated only if the signal characteristic of interest crosses the trigger threshold (with positive slope) after having been below the threshold for at least the holdoff time. For negative slope, the trigger event is generated if the signal characteristic crosses

the threshold (with negative slope) and then remains below the threshold for at least the holdoff time. In either case, the trigger event is associated with the time the level was crossed.

Key Path	Trigger, Auto/Holdoff
Remote Command	:TRIGger[:SEquence]:HOLDoff:TYPE NORMal ABOVE BELOW :TRIGger[:SEquence]:HOLDoff:TYPE?
Example	TRIG:HOLD:TYPE NORM
Preset	All modes but GSM/EDGE: Normal GSM/EDGE: Below
State Saved	Saved in instrument state
Initial S/W Revision	A.02.00

Trigger Offset (Remote Command Only)

ESA Backwards Compatibility command

Remote Command	:TRIGger[:SEquence]:OFFSet <time> :TRIGger[:SEquence]:OFFSet? :TRIGger[:SEquence]:OFFSet:STATE OFF ON 0 1 :TRIGger[:SEquence]:OFFSet:STATE?
Example	TRIG:OFFS ON TRIG:OFFS -100 ms
Notes	These are ESA commands for trigger offset that allowed you to use a positive or negative delay when in zero span and in a Res BW >= 1 kHz. For ESA compatibility, X-series analyzers keep track of this offset and add it to the Trigger Delay for line, video or external whenever the value is sent to the hardware, if in Zero Span and RBW >= 1 kHz.
Preset	Off, 0 s
State Saved	Saved in instrument state
Min	-11 s
Max	+11 s
Initial S/W Revision	Prior to A.02.00

Trigger

View/Display

The View/Display key opens up the Display Menu (common to most measurements) and the View menu for the current measurement.

Some measurements have simple View menus, or even no View menu, others provide many different Views.

Views are different ways of looking at data, usually different ways of looking at the same data, especially when the data represents a time record that is being digitally processed with an FFT and/or other digital signal processing algorithms.

Key Path	Front-panel key
Initial S/W Revision	Prior to A.02.00

Display

The **Display** menu is common to most measurements, and is used for configuring items on the display. Some **Display** menu settings apply to all the measurements in a mode, and some only to the current measurement. Those under the **System Display Settings** key apply to all measurements in all modes.

Key Path	Display
Initial S/W Revision	Prior to A.02.00

Annotation

Turns on and off various parts of the display annotation. The annotation is divided up into four categories:

1. **Meas Bar:** This is the measurement bar at the top of the screen. It does not include the settings panel or the Active Function. Turning off the Meas Bar turns off the settings panel and the Active Function. When the Meas Bar is off, the graticule area expands to fill the area formerly occupied by the Meas Bar.
2. **Screen Annotation:** this is the annotation and annunciation around the graticule, including any annotation on lines (such as the display line, the threshold line, etc.) This does NOT include the marker number or the N dB result. When off, the graticule expands to fill the entire graticule area.
3. **Trace annotation:** these are the labels on the traces, showing their detector (or their math mode).
4. **Active Function annotation:** this is the active function display in the meas bar, and all of the active function values displayed on softkeys.

See the figure below. Each type of annotation can be turned on and off individually.

View/Display

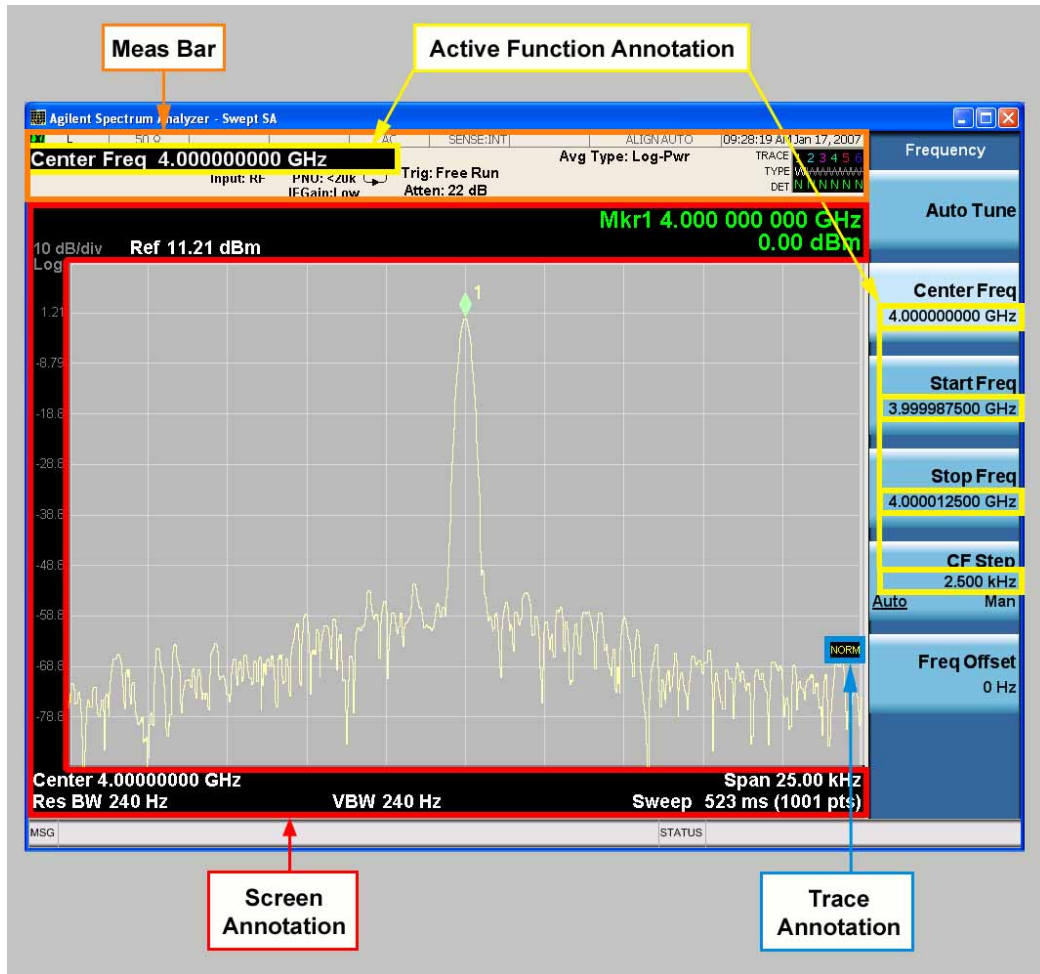

Key Path	View/Display, Display
Initial S/W Revision	Prior to A.02.00

Meas Bar On/Off

This function turns the Measurement Bar on and off, including the settings panel. When off, the graticule area expands to fill the area formerly occupied by the Measurement Bar.

Key Path	View/Display, Display, Annotation
Remote Command	:DISPlay:ANNotation:MBAR[:STATe] OFF ON 0 1 :DISPlay:ANNotation:MBAR[:STATe]?
Example	DISP:ANN:MBAR OFF
Dependencies	Grayed out and forced to OFF when System Display Settings, Annotation is set to Off.

Preset	On This should remain Off through a Preset when System Display Settings, Annotation is set to Off.
State Saved	Saved in instrument state.
Initial S/W Revision	Prior to A.02.00

Screen

This controls the display of the annunciation and annotation around the graticule, including any annotation on lines (such as the display line, the threshold line, etc.) and the y-axis annotation. This does NOT include marker annotation (or the N dB result). When off, the graticule expands to fill the entire graticule area, leaving only the 1.5% gap above the graticule as described in the Trace/Detector chapter.

Key Path	View/Display, Display, Annotation
Remote Command	:DISPlay:ANNotation:SCREen[:STATe] OFF ON 0 1 :DISPlay:ANNotation:SCREen[:STATe] ?
Example	DISP:ANN:SCR OFF
Dependencies	Grayed out and forced to OFF when System Display Settings, Annotation is set to Off.
Preset	On This should remain Off through a Preset when System Display Settings, Annotation is set to Off
State Saved	Saved in instrument state.
Initial S/W Revision	Prior to A.02.00

Trace

Turns on and off the labels on the traces, showing their detector (or their math mode) as described in the Trace/Detector section.

If trace math is being performed with a trace, then the trace math annotation will replace the detector annotation.

Key Path	View/Display, Display, Annotation
Remote Command	:DISPlay:ANNotation:TRACe[:STATe] ON OFF 1 0 :DISPlay:ANNotation:TRACe[:STATe] ?
Example	DISP:ANN:TRAC OFF
Preset	Off
State Saved	Saved in instrument state.
Initial S/W Revision	Prior to A.02.00

View/Display

Active Function Values On/Off

Turns on and off the active function display in the Meas Bar, and all of the active function values displayed on the softkeys.

Note that all of the softkeys that have active functions have these numeric values blanked when this function is on. This is a security feature..

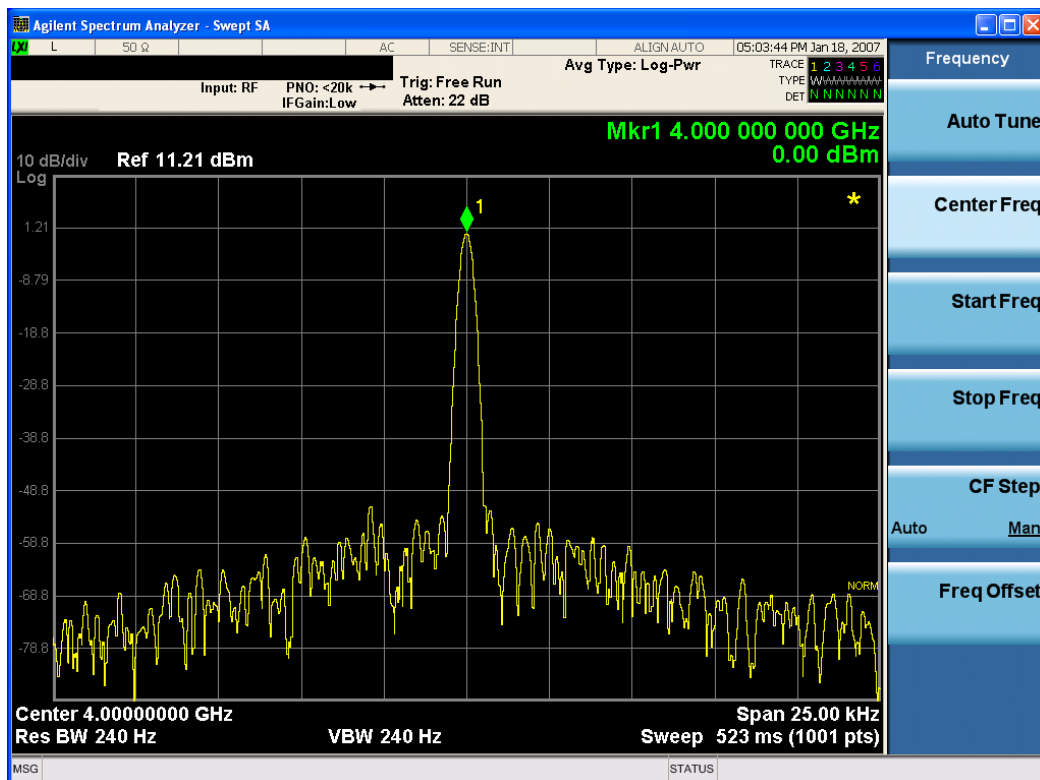

Key Path	View/Display, Display, Annotation
Remote Command	:DISPlay:ACTivefunc [:STATE] ON OFF 1 0 :DISPlay:ACTivefunc [:STATE] ?
Example	DISP:ACT OFF
Dependencies	Grayed out and forced to OFF when System Display Settings, Annotation is set to Off.
Preset	On This should remain Off through a Preset when System Display Settings, Annotation is set to Off
State Saved	Saved in instrument state.
Initial S/W Revision	Prior to A.02.00

Title

Displays menu keys that enable you to change or clear a title on your display.

Key Path	View/Display, Display
Initial S/W Revision	Prior to A.02.00

Change Title

Writes a title into the "measurement name" field in the banner, for example, "Swept SA".

Press Change Title to enter a new title through the alpha editor. Press Enter or Return to complete the entry. Press ESC to cancel the entry and preserve your existing title.

The display title will replace the measurement name. It remains for this measurement until you press **Change Title** again, or you recall a state, or a Preset is performed. A title can also be cleared by pressing **Title, Clear Title**.

NOTE

Notice the inclusion of the <measurement> parameter in the command below. Because each measurement remembers the Display Title, the command must be qualified with the measurement name. For the Swept SA measurement this is not the case; for backwards compatibility, no <measurement> parameter is used when changing the Display Title for the Swept SA measurement.

Key Path	View/Display, Display, Title
Mode	All
Remote Command	:DISPlay:<measurement>:ANNotation:TITLe:DATA <string> :DISPlay:<measurement>:ANNotation:TITLe:DATA?
Example	DISP:ANN:TITL:DATA "This Is My Title" This example is for the Swept SA measurement in the Spectrum Analyzer mode. The SANalyzer <measurement> name is not used. DISP:ACP:ANN:TITL:DATA "This Is My Title" This example is for Measurements other than Swept SA. Both set the title to: This Is My Title
Notes	Pressing this key cancels any active function. When a title is edited the previous title remains intact (it is not cleared) and the cursor goes at the end so that characters can be added or BKSP can be used to go back over previous characters.
Preset	No title (measurement name instead)
State Saved	Saved in instrument state.
Initial S/W Revision	Prior to A.02.00

View/Display

Clear Title

Clears a title from the front-panel display. Once cleared, the title cannot be retrieved. After the title is cleared, the current Measurement Name replaces it in the title bar.

Key Path	View/Display, Display, Title
Example	DISP:ANN:TITL:DATA "" clears any existing title characters.
Notes	Use the :DISPlay:ANNotation:TITLe:DATA <string> command with an empty string.
Preset	Performed on Preset.
Initial S/W Revision	Prior to A.02.00

Graticule

Pressing Graticule turns the display graticule On or Off. It also turns the graticule y-axis annotation on and off.

Key Path	View/Display, Display
Remote Command	:DISPlay:WINDow [1] :TRACe:GRATICule:GRID [:STATe] OFF ON 0 1 :DISPlay:WINDow [1] :TRACe:GRATICule:GRID [:STATe] ?
Example	DISP:WIND:TRAC:GRAT:GRID OFF
Notes	The graticule is the set of horizontal and vertical lines that make up the grid/divisions for the x-axis and y-axis.
Preset	On
State Saved	saved in instrument state
Initial S/W Revision	Prior to A.02.00

Display Line

Activates an adjustable horizontal line that is used as a visual reference line. The line's vertical position corresponds to its amplitude value. The value of the display line (for example, "-20.3 dBm") appears above the line itself on the right side of the display in the appropriate font.

The display line can be adjusted using the step keys, knob, or numeric keypad. The unit of the Display Line is determined by the **Y axis unit** setting under **Amplitude**. If more than one window has a display line, the display line of the selected window is controlled.

If the display line is off the screen, it shows as a line at the top/bottom of the screen with an arrow pointing up or down. As with all such lines (Pk Thresh, Trigger Level, etc.) it is drawn on top of all traces.

The display line is unaffected by Auto Couple.

Key Path	View/Display, Display
----------	------------------------------

Remote Command	:DISPlay:WINDow[1]:TRACe:Y:DLINe <amp;gt; :DISPlay:WINDow[1]:TRACe:Y:DLINe? :DISPlay:WINDow[1]:TRACe:Y:DLINe:STATe OFF ON 0 1 :DISPlay:WINDow[1]:TRACe:Y:DLINe:STATe?
Example	DISP:WIND:TRAC:Y:DLIN:STAT ON DISP:WIND:TRAC:Y:DLIN:STAT -32 dBm
Preset	Set the Display Line to Off and -25 dBm on Preset. When the Display Line goes from Off to On, if it is off screen, set it to either the top or bottom of screen, depending on which direction off screen it was. The Display Line's value does not change when it is turned off.
State Saved	Saved in instrument state.
Min	-∞ (minus infinity) in current units
Max	+∞ (plus infinity) in current units
Default Unit	Depends on the current selected Y axis unit
Initial S/W Revision	Prior to A.02.00

System Display Settings

These settings are "Mode Global" – they affect all modes and measurements and are reset only by **Restore Misc Defaults** or **Restore System Defaults** under System.

Key Path	View/Display, Display
Initial S/W Revision	Prior to A.02.00

Annotation Local Settings

This is a Mode Global override of the meas local annotation settings. When it is **All Off**, it forces **Screen Annotation, Meas Bar, Trace, and Active Function Values** settings to be **OFF** for all measurements in all modes. This provides the security based "annotation off" function of previous analyzers; hence it uses the legacy SCPI command.

When it is **All Off**, the **Screen, Meas Bar, Trace, and Active Function Values** keys under the **Display, Annotation** menu are grayed out and forced to **Off**. When **Local Settings** is selected, you are able to set the local annotation settings on a measurement by measurement basis.

Key Path	View/Display, Display, System Display Settings
Remote Command	:DISPlay:WINDow[1]:ANNOtation[:ALL] OFF ON 0 1 :DISPlay:WINDow[1]:ANNOtation[:ALL]?
Example	:DISP:WIND:ANN OFF
Preset	On (Set by Restore Misc Defaults)

View/Display

State Saved	Not saved in instrument state.
Initial S/W Revision	Prior to A.02.00

Theme

This key allows you to change the Display theme. This is similar to the Themes selection under Page Setup and Save Screen Image. The four themes are detailed below.

Key Path	View/Display, Display, System Display Settings
Remote Command	:DISPlay:THEME TDColor TDMonochrome FCOLor FMONochrome :DISPlay:THEMe?
Example	DISP:THEM TDM sets the display theme to 3D Monochrome.
Notes	TDColor – 3D is the standard color theme with filling and shading TDMonochrome – is similar to 3D color, but only black is used FCOLor – flat color is intended for inkjet printers to conserve ink. It uses a white background instead of black. FMONochrome – is like flat color, but only black is used
Preset	TDColor (Set by Restore Misc Defaults)
State Saved	Not saved in instrument state.
Initial S/W Revision	Prior to A.02.00

Backlight

Accesses the display backlight on/off keys. This setting may interact with settings under the Windows "Power" menu.

When the backlight is off, pressing ESC, TAB, SPACE, ENTER, UP, DOWN, LEFT, RIGHT, DEL, BKSP, CTRL, or ALT turns the backlight on without affecting the application. Pressing any other key will turn backlight on and could potentially perform the action as well.

Key Path	View/Display, Display, System Display Settings
Remote Command	:DISPlay:BACKlight ON OFF :DISPlay:BACKlight?
Preset	ON (Set by Restore Misc Defaults)
Initial S/W Revision	Prior to A.02.00

On

Turns the display backlight on.

Key Path	View/Display, Display, System Display Settings, Backlight
Example	DISP:BACK ON

Readback	On
Initial S/W Revision	Prior to A.02.00

Off

Turns the display backlight off.

Key Path	View/Display, Display, System Display Settings, Backlight
Example	DISP:BACK OFF
Readback	Off
Initial S/W Revision	Prior to A.02.00

Backlight Intensity

An active function used to set the backlight intensity. It goes from 0 to 100 where 100 is full on and 0 is off. This value is independent of the values set under the Backlight on/off key.

Key Path	View/Display, Display, System Display Settings
Remote Command	:DISPlay:BACKlight:INTensity <integer> :DISPlay:BACKlight:INTensity?
Example	DISP:BACK:INT 50
Preset	100 (Set by Restore Misc Defaults)
Min	0
Max	100
Initial S/W Revision	Prior to A.02.00

Full Screen

When **Full Screen** is pressed the measurement window expands horizontally over the entire instrument display. The screen graticule area expands to fill the available display area.

It turns off the display of the softkey labels, however the menus and active functions still work. (Though it would obviously be very hard to navigate without the key labels displayed.) Pressing **Full Screen** again while Full Screen is in effect cancels Full Screen.

Note that the banner and status lines are unaffected. You can get even more screen area for your data display by turning off the Meas Bar (in the Display menu) which also turns off the settings panel.

Full Screen is a Meas Global function. Therefore it is cancelled by the **Preset** key.

Key Path	Front-panel key
Remote Command	:DISPlay:FSCreen[:STATe] OFF ON 0 1 :DISPlay:FSCreen[:STATe]?

View/Display

Preset	Off
State Saved	Not saved in instrument state.
Backwards Compatibility SCPI	:DISPlay:MENU[:STATe] OFF ON 0 1
Backwards Compatibility SCPI	DISPlay:MENU[:STATe] emulates ESA full screen functionality, which is the same as the FSCReen command in PSA except that the sense of on/off is reversed (that is, OFF means the menus are OFF) and the default is ON.
Initial S/W Revision	Prior to A.02.00

Display Enable (Remote Command Only)

Turns the display on/off, including the display drive circuitry. The backlight stays lit so you can tell that the instrument is on. The display enable setting is mode global. The reasons for turning the display off are three:

- To increase speed as much as possible by freeing the instrument from having to update the display
- To reduce emissions from the display, drive circuitry
- For security purposes

If you have turned off the display:

- and you are in local operation, the display can be turned back on by pressing any key or by sending the SYSTem:DEFaults MISC command or the DISPlay:ENABle ON (neither *RST nor SYSTem:PRESet enable the display.)
- and you are in remote operation, the display can be turned back on by pressing the **Local** or **Esc** keys or by sending the SYSTem:DEFaults MISC command or the DISPlay:ENABle ON (neither *RST nor SYSTem:PRESet enable the display.)

and you are using either the SYSTem:KLOCK command or GPIB local lockout, then no front-panel key press will turn the display back on. You must turn it back on remotely.

Remote Command	:DISPlay:ENABle OFF ON 0 1 :DISPlay:ENABle?
Example	DISP:ENAB OFF
Couplings	DISP:ENAB OFF turns Backlight OFF and DISP:ENAB ON turns Backlight ON. However, settings of Backlight do not change the state of DISP:ENAB
Preset	On Set by SYST:DEF MISC, but Not affected by *RST or SYSTem:PRESet.
State Saved	Not saved in instrument state.
Initial S/W Revision	Prior to A.02.00

A **Appendix A: Channel Identification Plans**

This appendix contains channel and frequency information for the following TV standards:

- NTSC
- PAL

NTSC channels

NTSC, short for National Television System Committee, is the analog television system used in the United States, Canada, Japan, Mexico, the Philippines, South Korea, Taiwan, and some other countries.

NTSC-M and PAL-M shares the same frequency bands.

NTSC-M

NTSC-M AIR and PAL-M AIR

Channel Number	Frequency Band (MHz)
2	54~60
3	60~66
4	66~72
5	76~82
6	82~88
7	174~180
8	180~186
9	186~192
10	192~198
11	198~204
12	204~210
13	210~216
14	470~476
15	476~482
16	482~488
17	488~494
18	494~500
19	500~506
20	506~512
21	512~518
22	518~524
23	524~530
24	530~536
25	536~542
26	542~548
27	548~554
28	554~560
29	560~566

Appendix A: Channel Identification Plans
NTSC channels

Channel Number	Frequency Band (MHz)
30	566~572
31	572~578
32	578~584
33	584~590
34	590~596
35	596~602
36	602~608
37	608~614
38	614~620
39	620~626
40	626~632
41	632~638
42	638~644
43	644~650
44	650~656
45	656~662
46	662~668
47	668~674
48	674~680
49	680~686
50	686~692
51	692~698
52	698~704
53	704~710
54	710~716
55	716~722
56	722~728
57	728~734
58	734~740
59	740~746

Channel Number	Frequency Band (MHz)
60	746~752
61	752~758
62	758~764
63	764~770
64	770~776
65	776~782
66	782~788
67	788~794
68	794~800
69	800~806

Appendix A: Channel Identification Plans
NTSC channels

NTSC-M STD/HRC/IRC and PAL-M STD/HRC/IRC

Channel Designation	Picture Carrier Frequency (MHz)			Historical Reference
	STD	HRC	IRC	
1	N/A	72.0036	73.2625	4+,
2	55.25	54.0027	55.2625	
3	61.25	60.0030	61.2625	
4	67.25	66.0033	67.2625	
5	77.25	78.0039	79.2625	A-7(HRC,IRC)
6	83.25	84.0042	85.2625	A-6(HRC,IRC)
7	175.25	174.0087	175.2625	
8	181.25	180.0090	181.2625	
9	187.25	186.0093	187.2625	
10	193.25	192.0096	193.2625	
11	199.25	198.0099	199.2625	
12	205.25	204.0102	205.2625	
13	211.25	210.0105	211.2625	
14	121.2625	120.0060	121.2625	A
15	127.2625	126.0063	127.2625	B
16	133.2625	132.0066	133.2625	C
17	139.25	138.0069	139.2625	D
18	145.25	144.0072	145.2625	E
19	151.25	150.0075	151.2625	F
20	157.25	156.0078	157.2625	G
21	163.25	162.0081	163.2625	H
22	169.25	168.0084	169.2625	I
23	217.25	216.0108	217.2625	J
24	223.25	222.0111	223.2625	K
25	229.2625	228.0114	229.2625	L
26	235.2625	234.0117	235.2625	M
27	241.2625	240.0120	241.2625	N
28	247.2625	246.0123	247.2625	O

Channel Designation	Picture Carrier Frequency (MHz)			Historical Reference
29	253.2625	252.0126	253.2625	P
30	259.2625	258.0129	259.2625	Q
31	265.2625	264.0132	265.2625	R
32	271.2625	270.0135	271.2625	S
33	277.2625	276.0138	277.2625	T
34	283.2625	282.0141	283.2625	U
35	289.2625	288.0144	289.2625	V
36	295.2625	294.0147	295.2625	W
37	301.2625	300.0150	301.2625	X
38	307.2625	306.0153	307.2625	Y
39	313.2625	312.0156	313.2625	Z
40	319.2625	318.0159	319.2625	DD
41	325.2625	324.0162	325.2625	EE
42	331.2750a	330.0165	331.2750a	FF
43	337.2625	336.0168	337.2625	GG
44	343.2625	342.0171	343.2625	HH
45	349.2625	348.0174	349.2625	II
46	355.2625	354.0177	355.2625	JJ
47	361.2625	360.0180	361.2625	KK
48	367.2625	366.0183	367.2625	LL
49	373.2625	372.0186	373.2625	MM
50	379.2625	378.0189	379.2625	NN
51	385.2625	384.0192	385.2625	OO
52	391.2625	390.0195	391.2625	PP
53	397.2625	396.0198	397.2625	QQ
54	403.25	402.0201	403.2625	RR
55	409.25	408.0204	409.2625	SS
56	415.25	414.0207	415.2625	TT
57	421.25	420.0210	421.2625	UU
58	427.25	426.0213	427.2625	VV

Appendix A: Channel Identification Plans
NTSC channels

Channel Designation	Picture Carrier Frequency (MHz)			Historical Reference
59	433.25	432.0216	433.2625	WW
60	439.25	438.0219	439.2625	XX
61	445.25	444.0222	445.2625	YY
62	451.25	450.0225	451.2625	ZZ
63	457.25	456.0228	457.2625	
64	463.25	462.0231	463.2625	
65	469.25	468.0234	469.2625	
66	475.25	474.0237	475.2625	
67	481.25	480.0240	481.2625	
68	487.25	486.0243	487.2625	
69	493.25	492.0246	493.2625	
70	499.25	498.0249	499.2625	
71	505.25	504.0252	505.2625	
72	511.25	510.0255	511.2625	
73	517.25	516.0258	517.2625	
74	523.25	522.0261	523.2625	
75	529.25	528.0264	529.2625	
76	535.25	534.0267	535.2625	
77	541.25	540.0270	541.2625	
78	547.25	546.0273	547.2625	
79	553.25	552.0276	553.2625	
80	559.25	558.0279	559.2625	
81	565.25	564.0282	565.2625	
82	571.25	570.0285	571.2625	
83	577.25	576.0288	577.2625	
84	583.25	582.0291	583.2625	
85	589.25	588.0294	589.2625	
86	595.25	594.0297	595.2625	
87	601.25	600.0300	601.2625	
88	607.25	606.0303	607.2625	

Channel Designation	Picture Carrier Frequency (MHz)			Historical Reference
89	613.25	612.0306	613.2625	
90	619.25	618.0309	619.2625	
91	625.25	624.0312	625.2625	
92	631.25	630.0315	631.2625	
93	637.25	636.0318	637.2625	
94	643.25	642.0321	643.2625	
95	91.25	90.0045	91.2625	A-5
96	97.25	96.0048	97.2625	A-4
97	103.25	102.0051	103.2625	A-3
98	109.2750a	108.0250	109.2750a	A-2
99	115.2750a	114.0250	115.2750a	A-1
100	649.2500	648.0324	649.2625	
101	655.2500	654.0327	655.2625	
102	661.2500	660.0330	661.2625	
103	667.2500	666.0333	667.2625	
104	673.2500	672.0336	673.2625	
105	679.2500	678.0339	679.2625	
106	685.2500	684.0342	685.2625	
107	691.2500	690.0345	691.2625	
108	697.2500	696.0348	697.2625	
109	703.2500	702.0351	703.2625	109
110	709.2500	708.0354	709.2625	110
111	715.2500	714.0357	715.2625	111
112	721.2500	720.0360	721.2625	112
113	727.2500	726.0363	727.2625	113
114	733.2500	732.0366	733.2625	114
115	739.2500	738.0369	739.2625	115
116	745.2500	744.0372	745.2625	116
117	751.2500	750.0375	751.2625	117
118	757.2500	756.0378	757.2625	118

Appendix A: Channel Identification Plans
NTSC channels

Channel Designation	Picture Carrier Frequency (MHz)			Historical Reference
119	763.2500	762.0381	763.2625	119
120	769.2500	768.0384	769.2625	120
121	775.2500	774.0387	775.2625	121
122	781.2500	780.0390	781.2625	122
123	787.2500	786.0393	787.2625	123
124	793.2500	792.0396	793.2625	124
125	799.2500	798.0399	799.2625	125
126	805.2500	804.0402	805.2625	126
127	811.2500	810.0405	811.2625	127
128	817.2500	816.0408	817.2625	128
129	823.2500	822.0411	823.2625	129
130	829.2500	828.0414	829.2625	130
131	835.2500	834.0417	835.2625	131
132	841.2500	840.0420	841.2625	132
133	847.2500	846.0423	847.2625	133
134	853.2500	852.0426	853.2625	134
135	859.2500	858.0429	859.2625	135
136	865.2500	864.0432	856.2625	136
137	871.2500	870.0435	871.2625	137
138	877.2500	876.0438	877.2625	138
139	883.2500	882.0441	883.2625	139
140	889.2500	888.0444	889.2625	140
141	895.2500	894.0447	895.2625	141
142	901.2500	900.0450	901.2625	142
143	907.2500	906.0453	907.2625	143
144	913.2500	912.0456	913.2625	144
145	919.2500	918.0459	919.2625	145
146	925.2500	924.0462	925.2625	146
147	931.2500	930.0465	931.2625	147
148	937.2500	936.0468	937.2625	148

Channel Designation	Picture Carrier Frequency (MHz)			Historical Reference
149	943.2500	942.0471	943.2625	149
150	949.2500	948.0474	949.2625	150
151	955.2500	954.0477	955.2625	151
152	961.2500	960.0480	961.2625	152
153	967.2500	966.0483	967.2625	153
154	973.2500	972.0486	973.2625	154
155	979.2500	978.0489	979.2625	155
156	985.2500	984.0492	985.2625	156
157	991.2500	990.0495	991.2625	157
158	997.2500	996.0498	997.2625	158

a. This frequency deviates from the pattern.

Appendix A: Channel Identification Plans
NTSC channels

NTSC-J

NTSC-J Cable

Band	Channel Number	Frequency Band (MHz)	Picture Carrier (MHz)	Audio Carrier (MHz)
Mid Band	13	108–114	109.25	113.75
	14	114–120	115.25	119.75
	15	120–126	121.25	125.75
	16	126–132	127.25	131.75
	17	132–138	133.25	137.75
	18	138–144	139.25	143.75
	19	144–150	145.25	149.75
	20	150–156	151.25	155.75
	21	156–162	157.25	161.75
	22	164–170	165.25	169.75

Band	Channel Number	Frequency Band (MHz)	Picture Carrier (MHz)	Audio Carrier (MHz)
Super High Band	23	222–228	223.25	227.75
	24	230–236	231.25	235.75
	25	236–242	237.25	241.75
	26	242–248	243.25	247.75
	27	248–254	249.25	253.75
	28	252–258	253.25	257.75
	29	258–264	259.25	263.75
	30	264–270	265.25	269.75
	31	270–276	271.25	275.75
	32	276–282	277.25	281.75
	33	282–288	283.25	287.75
	34	288–294	289.25	293.75
	35	294–300	295.25	299.75
	36	300–306	301.25	305.75
	37	306–313	307.25	311.75
	38	312–318	313.25	317.75
	39	318–324	319.25	323.75
	40	324–330	325.25	329.75
	41	330–336	331.25	335.75
	42	336–342	337.25	341.75
	43	342–348	343.25	347.75
	44	348–354	349.25	353.75
	45	354–360	355.25	359.75
	46	360–366	361.25	365.75
	47	366–372	367.25	371.75
	48	372–378	373.25	377.75
	49	378–384	379.25	383.75
	50	384–390	385.25	389.75
	51	390–396	391.25	395.75
	52	396–402	397.25	401.75

Appendix A: Channel Identification Plans
NTSC channels

Band	Channel Number	Frequency Band (MHz)	Picture Carrier (MHz)	Audio Carrier (MHz)
Super High Band(Continued)	53	402–408	403.25	407.75
	54	408–414	409.25	413.75
	55	414–420	415.25	419.75
	56	420–426	421.25	425.75
	57	426–432	427.25	431.75
	58	432–438	433.25	437.75
	59	438–444	439.25	443.75
	60	444–450	445.25	449.75
	61	450–456	451.25	455.75
	62	456–462	457.25	461.75
	63	462–468	463.25	467.75

NTSC-J AIR

Channel Number	Frequency Band (MHz)	Picture Carrier (MHz)	Audio Carrier (MHz)
1	90~96	91.25	95.75
2	96~102	97.25	101.75
3	102~108	103.25	107.75
4	170~176	171.25	175.75
5	176~182	177.25	181.75
6	182~188	183.25	187.75
7	188~194	189.25	193.75
8	192~198a	193.25	197.75
9	198~204	199.25	203.75
10	204~210	205.25	209.75
11	210~216	211.25	215.75
12	216~222	217.25	221.75
13	470.142857 ~476.142857	471.25	475.75
14	476.142857 ~482.142857	477.25	481.75
15	482.142857 ~488.142857	483.25	487.75
16	488.142857 ~494.142857	489.25	493.75
17	494.142857 ~500.142857	495.25	499.75
18	500.142857 ~506.142857	501.25	505.75
19	506.142857 ~512.142857	507.25	511.75
20	512.142857 ~518.142857	513.25	517.75
21	518.142857 ~524.142857	519.25	523.75
22	524.142857 ~530.142857	515.25	529.75

Appendix A: Channel Identification Plans
NTSC channels

Channel Number	Frequency Band (MHz)	Picture Carrier (MHz)	Audio Carrier (MHz)
23	530.142857 ~536.142857	531.25	535.75
24	536.142857 ~542.142857	537.25	541.75
25	542.142857 ~548.142857	543.25	547.75
26	548.142857 ~554.142857	549.25	553.75
27	554.142857 ~560.142857	555.25	559.75
28	560.142857 ~566.142857	561.25	565.75
29	566.142857 ~572.142857	567.25	571.75
30	572.142857 ~578.142857	573.25	577.75
31	578.142857 ~584.142857	579.25	583.75
32	584.142857 ~590.142857	585.25	589.75
33	590.142857 ~596.142857	591.25	595.75
34	596.142857 ~602.142857	597.25	601.75
35	602.142857 ~608.142857	603.25	607.75
36	608.142857 ~614.142857	609.25	613.75
37	614.142857 ~620.142857	615.25	619.75
38	620.142857 ~626.142857	621.25	625.75
39	626.142857 ~632.142857	627.25	631.75
40	632.142857 ~638.142857	633.25	637.75

Channel Number	Frequency Band (MHz)	Picture Carrier (MHz)	Audio Carrier (MHz)
41	638.142857 ~644.142857	639.25	643.75
42	644.142857 ~650.142857	645.25	649.75
43	650.142857 ~656.142857	651.25	655.75
44	656.142857 ~662.142857	657.25	661.75
45	662.142857 ~668.142857	663.25	667.75
46	668.142857 ~674.142857	669.25	673.75
47	674.142857 ~680.142857	675.25	679.75
48	680.142857 ~686.142857	681.25	685.75
49	686.142857 ~692.142857	687.25	691.75
50	692.142857 ~698.142857	693.25	697.75
51	698.142857 ~704.142857	699.25	703.75
52	704.142857 ~710.142857	705.25	709.75
53	710.142857 ~716.142857	711.25	715.75
54	716.142857 ~722.142857	717.25	721.75
55	722.142857 ~728.142857	723.25	728.75
56	728.142857 ~734.142857	729.25	733.75
57	734.142857 ~740.142857	735.25	739.75
58	740.142857 ~746.142857	741.25	745.75

Appendix A: Channel Identification Plans
NTSC channels

Channel Number	Frequency Band (MHz)	Picture Carrier (MHz)	Audio Carrier (MHz)
59	746.142857 ~752.142857	747.25	751.75
60	752.142857 ~758.142857	753.25	757.75
61	758.142857 ~764.142857	759.25	763.75
62	764.142857 ~770.142857	765.25	769.75

a. This frequency deviates from the pattern.

NTSC-Brazil

NTSC-Brazil VHF

Channel	Initial frequency MHz	Final frequency MHz	Central frequency MHz
07	174	180	177+ 1/7
08	180	186	183+ 1/7
09	186	192	189+ 1/7
10	192	198	195+ 1/7
11	198	204	201+ 1/7
12	204	210	207+ 1/7
13	210	216	213+ 1/7

NTSC-Brazil UHF

Channel	Initial frequency MHz	Final frequency MHz	Central frequency MHz
14	470	476	473+ 1/7
15	476	482	479+ 1/7
16	482	488	485+ 1/7
17	488	494	491+ 1/7
18	494	500	497+ 1/7
19	500	506	503+ 1/7

Appendix A: Channel Identification Plans
NTSC channels

Channel	Initial frequency MHz	Final frequency MHz	Central frequency MHz
20	506	512	509+ 1/7
21	512	518	515+ 1/7
22	518	524	521+ 1/7
23	524	530	527+ 1/7
24	530	536	533+ 1/7
25	536	542	539+ 1/7
26	542	548	545+ 1/7
27	548	554	551+ 1/7
28	554	560	557+ 1/7
29	560	566	563+ 1/7
30	566	572	569+ 1/7
31	572	578	575+ 1/7
32	578	584	581+ 1/7
33	584	590	587+ 1/7
34	590	596	593+ 1/7
35	596	602	599+ 1/7
36	602	608	605+ 1/7
37	Not used for television	Not used for television	Not used for television
38	614	620	617+ 1/7
39	620	626	623+ 1/7
40	626	632	629+ 1/7
41	632	638	635+ 1/7
42	638	644	641+ 1/7
43	644	650	647+ 1/7
44	650	656	653+ 1/7
45	656	662	659+ 1/7
46	662	668	665+ 1/7
47	668	674	671+ 1/7
48	674	680	677+ 1/7
49	680	686	683+ 1/7

Appendix A: Channel Identification Plans
NTSC channels

Channel	Initial frequency MHz	Final frequency MHz	Central frequency MHz
50	686	692	689+ 1/7
51	692	698	695+ 1/7
52	698	704	701+ 1/7
53	704	710	707+ 1/7
54	710	716	713+ 1/7
55	716	722	719+ 1/7
56	722	728	725+ 1/7
57	728	734	731+ 1/7
58	734	740	737+ 1/7
59	740	746	743+ 1/7
60	746	752	749+ 1/7
61	752	758	755+ 1/7
62	758	764	761+ 1/7
63	764	770	767+ 1/7
64	770	776	773+ 1/7
65	776	782	779+ 1/7
66	782	788	785+ 1/7
67	788	794	791+ 1/7
68	794	800	797+ 1/7
69	800	806	803+ 1/7

PAL Channels

PAL, short for Phase Alternating Line, is a color-encoding system used in broadcast television systems in large parts of the world.

PAL-M

Refer to [“NTSC-M AIR and PAL-M AIR” on page 1325](#) and PAL-M AIR and [“NTSC-M STD/HRC/IRC and PAL-M STD/HRC/IRC” on page 1328](#).

PAL-I

PAL-I VHF

Channel	Channel Limits (MHz)	Vision Carrier (MHz)	Sound Carrier (MHz)
1	44.5~52.5	45.75	51.75
2	52.5~60.5	53.75	59.75
3	60.5~68.5	61.75	67.75
4	174~182	175.25	181.25
5	182~190	183.25	183.25
6	190~198	191.25	197.25
7	198~206	199.25	205.25
8	206~214	207.25	213.25
9	214~222	215.25	221.25
10	222~230	223.25	229.25
11	230~238	231.25	237.25
12	238~246	239.25	245.25
13	246~254	247.43	253.43

PAL-I UHF

Refer to [“PAL-B/G UHF and PAL-I UHF” on page 1344](#).

PAL-I HRC

Refer to [“PAL B/G HRC and PAL-I HRC” on page 1347](#).

PAL-B/G

PAL-B/G VHF

Band	Channel	Channel Limits (MHz)	Vision Carrier (MHz)	Sound Carrier (MHz)
IF		33.15~40.15	38.9	33.4
I	E2	47~54	48.25	53.75
	E3	54~61	55.25	60.75
	E4	61~68	62.25	67.75
III	E5	174~181	175.25	180.75
	E6	181~188	182.25	187.75
	E7	188~195	189.25	194.75
	E8	195~202	196.25	210.75
	E9	202~209	203.25	208.75
	E10	209~216	210.25	215.75
	E11	216~223	217.25	222.75
	E12	223~230	224.25	229.75

PAL-B/G UHF and PAL-I UHF

Band	Channel	Channel Limits (MHz)	Vision Carrier (MHz)	Sound Carrier (MHz)		
				G, H	I	K, L
IF	same as VHF for corresponding country					
IV	21	470~478	471.25	476.75	477.25	477.75
	22	478~486	479.25	484.75	485.25	485.75
	23	486~494	487.25	492.75	493.25	493.75
	24	494~502	495.25	500.75	501.25	501.75
	25	502~510	503.25	508.75	509.25	509.75
	26	510~518	511.25	516.75	517.25	517.75
	27	518~526	519.25	524.75	525.25	525.75
	28	526~534	527.25	532.75	533.25	533.75
	29	534~542	535.25	540.75	541.25	541.75
	30	542~550	543.25	548.75	549.25	549.75

Appendix A: Channel Identification Plans
PAL Channels

Band	Channel	Channel Limits (MHz)	Vision Carrier (MHz)	Sound Carrier (MHz)		
	31	550~558	551.25	556.75	557.25	557.75
	32	558~566	559.25	564.75	565.25	565.75
	33	566~574	567.25	572.75	573.25	573.75
	34	574~582	575.25	580.75	581.25	581.75
	35	582~590	583.25	588.75	589.25	589.75
	36	590~598	591.25	596.75	597.25	597.75
	37	598~606	599.25	604.75	605.25	605.75
V	38	606~614	607.25	612.75	613.25	613.75
	39	614~622	615.25	620.75	621.25	621.75
	40	622~630	623.25	628.75	629.25	629.75
	41	630~638	631.25	636.75	637.25	637.75
	42	638~646	639.25	644.75	645.25	645.75
	43	646~654	647.25	652.75	653.25	653.75
	44	654~662	655.25	660.75	661.25	661.75
	45	662~670	663.25	668.75	669.25	669.75
	46	670~678	671.25	676.75	677.25	677.75
	47	678~686	679.25	684.755	685.25	685.75
	48	686~694	687.25	692.75	693.25	693.75
	49	694~702	695.25	700.75	701.25	701.75
	50	702~710	703.25	708.75	709.25	709.75
	51	710~718	711.25	716.75	717.25	717.75
	52	718~726	719.25	708.75	709.25	709.75
	53	726~734	727.25	732.75	733.25	733.75
	54	734~742	735.25	740.75	741.25	741.75
	55	742~750	743.25	748.75	749.25	749.75
	56	750~758	751.25	756.75	757.25	757.75
	57	758~766	759.25	764.75	765.25	765.75
	58	766~774	767.25	772.75	773.25	773.75
	59	774~782	775.25	780.75	781.25	781.75
	60	782~790	783.25	788.75	789.25	789.75

Appendix A: Channel Identification Plans
PAL Channels

Band	Channel	Channel Limits (MHz)	Vision Carrier (MHz)	Sound Carrier (MHz)		
	61	790~798	791.25	796.75	797.25	797.75
	62	798~806	799.25	804.75	805.25	805.75
	63	806~814	807.25	812.75	813.25	813.75
	64	814~822	815.25	820.75	821.25	821.75
	65	822~830	823.25	828.75	829.25	829.75
	66	830~838	831.25	836.75	837.25	837.75
	67	838~846	839.25	844.75	845.25	845.75
	68	846~854	847.25	852.75	853.25	853.75
	69	854~862	855.25	860.75	861.25	861.75

PAL B/G HRC and PAL-I HRC

Channel	Channel Limits (MHz)		Vision Carrier (MHz)	Sound Carrier (MHz)	
	Lower	Upper		B/G	I
2	54.75	62.75	56	61.5	62
3	62.75	70.75	64	69.5	70
4	70.75	78.75	72	77.5	78
5	78.75	86.75	80	85.5	86
6	86.75	94.75	88	93.5	94
7	94.75	102.75	96	101.5	102
8	102.75	110.75	104	109.5	110
9	110.75	118.75	112	117.5	118
10	118.75	126.75	120	125.5	126
11	126.75	134.75	128	133.5	134
12	134.75	142.75	136	141.5	142
13	142.75	150.75	144	149.5	150
14	150.75	158.75	152	157.5	158
15	158.75	166.75	160	165.5	166
16	166.75	174.75	168	173.5	174
17	174.75	182.75	176	181.5	182
18	182.75	190.75	184	189.5	190
19	190.75	198.75	192	197.5	198
20	198.75	206.75	200	205.5	206
21	206.75	214.75	208	213.5	214
22	214.75	222.75	216	221.5	222
23	222.75	230.75	224	229.5	230
24	230.75	238.75	232	237.5	238
25	238.75	246.75	240	245.5	246
26	246.75	254.75	248	253.5	254
27	254.75	262.75	256	261.5	262
28	262.75	270.75	264	269.5	270
29	270.75	278.75	272	277.5	278

Appendix A: Channel Identification Plans
PAL Channels

Channel	Channel Limits (MHz)		Vision Carrier (MHz)	Sound Carrier (MHz)	
30	278.75	286.75	280	285.5	286
31	286.75	294.75	288	293.5	294
32	294.75	302.75	296	301.5	302
33	302.75	310.75	304	309.5	310
34	310.75	318.75	312	317.5	318
35	318.75	326.75	320	325.5	326
36	326.75	334.75	328	333.5	334
37	334.75	342.75	336	341.5	342
38	342.75	350.75	344	349.5	350
39	350.75	358.75	352	357.5	358
40	358.75	366.75	360	365.5	366
41	366.75	374.75	368	373.5	374
42	374.75	382.75	376	381.5	382
43	382.75	390.75	384	389.5	390
44	390.75	398.75	392	397.5	398
45	398.75	406.75	400	405.5	406
46	406.75	414.75	408	413.5	414
47	414.75	422.75	416	421.5	422
48	422.75	430.75	424	429.5	430
49	430.75	438.75	432	437.5	438
50	438.75	446.75	440	445.5	446
51	446.75	454.75	448	453.5	454
52	454.75	462.75	456	461.5	462
53	462.75	470.75	464	469.5	470
54	470.75	478.75	472	477.5	478
55	478.75	486.75	480	485.5	486
56	486.75	494.75	488	493.5	494
57	494.75	502.75	496	501.5	502
58	502.75	510.75	504	509.5	510
59	510.75	518.75	512	517.5	518

Channel	Channel Limits (MHz)		Vision Carrier (MHz)	Sound Carrier (MHz)	
60	518.75	526.75	520	525.5	526
61	526.75	534.75	528	533.5	534
62	534.75	542.75	536	541.5	542
63	542.75	550.75	544	549.5	550
64	550.75	558.75	552	557.5	558
65	558.75	566.75	560	565.5	566
66	566.75	574.75	568	573.5	574
67	574.75	582.75	576	581.5	582
68	582.75	590.75	584	589.5	590
69	590.75	598.75	592	597.5	598
70	598.75	606.75	600	605.5	606
71	606.75	614.75	608	613.5	614
72	614.75	622.75	616	621.5	622
73	622.75	630.75	624	629.5	630
74	630.75	638.75	632	637.5	638
75	638.75	646.75	640	645.5	646
76	646.75	654.75	648	653.5	654
77	654.75	662.75	656	661.5	662
78	662.75	670.75	664	669.5	670
79	670.75	678.75	672	677.5	678
80	678.75	686.75	680	685.5	686
81	686.75	694.75	688	693.5	694
82	694.75	702.75	696	701.5	702
83	702.75	710.75	704	709.5	710
84	710.75	718.75	712	717.5	718
85	718.75	726.75	720	725.5	726
86	726.75	734.75	728	733.5	734
87	734.75	742.75	736	741.5	742
88	742.75	750.75	744	749.5	750
89	750.75	758.75	752	757.5	758

Appendix A: Channel Identification Plans
PAL Channels

Channel	Channel Limits (MHz)		Vision Carrier (MHz)	Sound Carrier (MHz)	
90	758.75	766.75	760	765.5	766
91	766.75	774.75	768	773.5	774
92	774.75	782.75	776	781.5	782
93	782.75	790.75	784	789.5	790
94	790.75	798.75	792	797.5	798
95	798.75	806.75	800	805.5	806
96	806.75	814.75	808	813.5	814
97	814.75	822.75	816	821.5	822
98	822.75	830.75	824	829.5	830
99	830.75	838.75	832	837.5	838
100	838.75	846.75	840	845.5	846
101	846.75	854.75	848	853.5	854
102	854.75	862.75	856	861.5	862
103	862.75	870.75	864	869.5	870
104	870.75	878.75	872	877.5	878
105	878.75	886.75	880	885.5	886
106	886.75	894.75	888	893.5	894
107	894.75	902.75	896	901.5	902
108	902.75	910.75	904	909.5	910
109	910.75	918.75	912	917.5	918
110	918.75	926.75	920	925.5	926
111	926.75	934.75	928	933.5	934
112	934.75	942.75	936	941.5	942
113	942.75	950.75	944	949.5	950
114	950.75	958.75	952	957.5	958
115	958.75	966.75	960	965.5	966
116	966.75	974.75	968	973.5	974
117	974.75	982.75	976	981.5	982
118	982.75	990.75	984	989.5	990
119	990.75	998.75	992	997.5	998

Channel	Channel Limits (MHz)		Vision Carrier (MHz)	Sound Carrier (MHz)	
120	998.75	1006.75	1000	1005.5	1006
121	1006.75	1014.75	1008	1013.5	1014
122	1014.75	1022.75	1016	1021.5	1022
123	1022.75	1030.75	1024	1029.5	1030
124	1030.75	1038.75	1032	1037.5	1038
125	1038.75	1046.75	1040	1045.5	1046
126	1046.75	1054.75	1048	1053.5	1054
127	1054.75	1062.75	1052	1061.5	1062
128	1062.75	1070.75	1064	1069.5	1070
129	1070.75	1078.75	1072	1077.5	1078
130	1078.75	1086.75	1080	1085.5	1086
131	1086.75	1094.75	1088	1093.5	1094
132	1094.75	1102.75	1096	1101.5	1102
133	1102.75	1110.75	1104	1109.5	1110
134	1110.75	1118.75	1112	1117.5	1118
135	1118.75	1126.75	1120	1125.5	1126
136	1126.75	1134.75	1128	1133.5	1134
137	1134.75	1142.75	1136	1141.5	1142
138	1142.75	1150.75	1144	1149.5	1150
139	1150.75	1158.75	1152	1157.5	1158
140	1158.75	1166.75	1160	1165.5	1166
141	1166.75	1174.75	1168	1173.5	1174
142	1174.75	1182.75	1176	1181.5	1182
143	1182.75	1190.75	1184	1189.5	1190
144	1190.75	1198.75	1192	1197.5	1198
145	1198.75	1206.75	1200	1205.5	1206
146	1206.75	1214.75	1208	1213.5	1214
147	1214.75	1222.75	1216	1221.5	1222
148	1222.75	1230.75	1224	1229.5	1230
149	1230.75	1238.75	1232	1237.5	1238

Appendix A: Channel Identification Plans
PAL Channels

Channel	Channel Limits (MHz)		Vision Carrier (MHz)	Sound Carrier (MHz)	
150	1238.75	1246.75	1240	1245.5	1246
151	1246.75	1254.75	1248	1253.5	1254
152	1254.75	1262.75	1256	1261.5	1262
153	1262.75	1270.75	1264	1269.5	1270
154	1270.75	1278.75	1272	1277.5	1278
155	1278.75	1286.75	1280	1285.5	1286
156	1286.75	1294.75	1288	1293.5	1294
157	1294.75	1302.75	1296	1301.5	1302
158	1302.75	1310.75	1304	1309.5	1310
159	1310.75	1318.75	1312	1317.5	1318
160	1318.75	1326.75	1320	1325.5	1326
161	1326.75	1334.75	1328	1333.5	1334
162	1334.75	1342.75	1336	1341.5	1342
163	1342.75	1350.75	1344	1349.5	1350
164	1350.75	1358.75	1352	1357.5	1358
165	1358.75	1366.75	1360	1365.5	1366
166	1366.75	1374.75	1368	1373.5	1374
167	1374.75	1382.75	1376	1381.5	1382
168	1382.75	1390.75	1384	1389.5	1390
169	1390.75	1398.75	1392	1397.5	1398
170	1398.75	1406.75	1400	1405.5	1406
171	1406.75	1414.75	1408	1413.5	1414
172	1414.75	1422.75	1416	1421.5	1422
173	1422.75	1430.75	1424	1429.5	1430
174	1430.75	1438.75	1432	1437.5	1438
175	1438.75	1446.75	1440	1445.5	1446
176	1446.75	1454.75	1448	1453.5	1454
177	1454.75	1462.75	1456	1461.5	1462
178	1462.75	1470.75	1464	1469.5	1470
179	1470.75	1478.75	1472	1477.5	1478

Channel	Channel Limits (MHz)		Vision Carrier (MHz)	Sound Carrier (MHz)	
180	1478.75	1486.75	1480	1485.5	1486
181	1486.75	1494.75	1488	1493.5	1494
182	1494.75	1502.75	1496	1501.5	1502
183	1502.75	1510.75	1504	1509.5	1510
184	1510.75	1518.75	1512	1517.5	1518
185	1518.75	1526.75	1520	1525.5	1526
186	1526.75	1534.75	1528	1533.5	1534
187	1534.75	1542.75	1536	1541.5	1542
188	1542.75	1550.75	1544	1549.5	1550
189	1550.75	1558.75	1552	1557.5	1558
190	1558.75	1566.75	1560	1565.5	1566
191	1566.75	1574.75	1568	1573.5	1574
192	1574.75	1582.75	1576	1581.5	1582
193	1582.75	1590.75	1584	1589.5	1590
194	1590.75	1598.75	1592	1597.5	1598
195	1598.75	1606.75	1600	1605.5	1606
196	1606.75	1614.75	1608	1613.5	1614
197	1614.75	1622.75	1616	1621.5	1622
198	1622.75	1630.75	1624	1629.5	1630
199	1630.75	1638.75	1632	1637.5	1638

Appendix A: Channel Identification Plans
PAL Channels

PAL-B/G S

Band	Channel	Channel Limits (MHz)	Vision Carrier (MHz)	Sound Carrier (MHz)
IF		33.15~40.15	38.9	33.4
L21	S1	104~111	105.25	110.75
	S2	111~118	112.25	117.75
	S3	118~125	119.25	124.75
	S4	125~132	126.25	131.75
	S5	132~139	133.25	138.75
	S6	139~146	140.25	145.75
	S7	146~153	147.25	152.75
	S8	153~160	154.25	159.75
	S9	160~167	161.25	166.75
	S10	167~174	168.25	173.75
U21	S11	230~237	231.25	236.75
	S12	237~244	238.25	243.75
	S13	244~251	245.25	250.75
	S14	251~258	252.25	257.75
	S15	258~265	259.25	264.75
	S16	265~272	266.25	271.75
	S17	272~279	273.25	278.75
	S18	279~286	280.25	285.75
	S19	286~293	287.25	292.75
	S20	293~300	294.25	299.75
	S21	302~310	303.25	308.75
	S22	310~318	311.25	316.75
	S23	318~326	319.25	324.75
	S24	326~334	327.25	332.75
	S25	334~342	335.25	340.75
	S26	342~350	343.25	348.75
	S27	350~358	351.25	356.75
	S28	358~366	359.25	364.75

Band	Channel	Channel Limits (MHz)	Vision Carrier (MHz)	Sound Carrier (MHz)
	S29	366~374	367.25	372.75
	S30	374~382	375.25	380.75
	S31	382~390	383.25	388.75
	S32	390~398	391.25	396.75
	S33	398~406	399.25	404.75
	S34	406~414	407.25	412.75
	S35	414~422	415.25	420.75
	S36	422~430	423.25	428.75
	S37	430~438	431.25	436.75
	S38	438~446	439.25	444.75
	S39	446~454	447.25	452.75
	S40	454~462	455.25	460.75
	S41	462~470	463.25	468.75

Appendix A: Channel Identification Plans
PAL Channels

PAL-B/G Cable

Band	Channel	Channel Limits (MHz)	Vision Carrier (MHz)	Sound Carrier (MHz)
IF		33.15~40.15	38.9	33.4
II	S1	104~111	105.25	110.75
	S2	111~118	112.25	117.75
	S3	118~125	119.25	124.75
	S4	125~132	126.25	131.75
	S5	132~139	133.25	138.75
	S6	139~146	140.25	145.75
	S7	146~153	147.25	152.75
	S8	153~160	154.25	159.75
	S9	160~167	161.25	166.75
	S10	167~174	168.25	173.75
U21	S11	230~237	231.25	236.75
	S12	237~244	238.25	243.75
	S13	244~251	245.25	250.75
	S14	251~258	252.25	257.75
	S15	258~265	259.25	264.75
	S16	265~272	266.25	271.75
	S17	272~279	273.25	278.75
	S18	279~286	280.25	285.75
	S19	286~293	287.25	292.75
	S20	293~300	294.25	299.75
	S21	300~307	301.25	306.75
	S22	307~314	311.25	316.75
	S23	314~321	315.25	320.75
	S24	321~328	322.25	327.75
	S25	328~335	329.25	334.75
	S26	335~342	336.25	341.75
	S27	342~349	343.25	348.75
	S28	349~356	350.25	355.75

Band	Channel	Channel Limits (MHz)	Vision Carrier (MHz)	Sound Carrier (MHz)
	S29	356~363	357.25	362.75
	S30	363~370	364.25	369.75
	S31	370~377	371.25	376.75
	S32	377~384	378.25	383.75
	S33	384~391	385.25	390.75
	S34	391~398	392.25	397.75
	S35	398~405	399.25	404.75
	S36	405~412	406.25	411.75
	S37	412~419	413.25	418.75
	S38	419~426	420.25	425.75
	S39	426~433	427.25	432.75
	S40	433~440	434.25	439.75
	S41	440~447	441.25	446.75
	S42	447~454	448.25	453.75
	S43	454~461	455.25	460.75
	S44	461~468	462.25	467.75

Appendix A: Channel Identification Plans
PAL Channels

PAL-B/G CENELEC

Channel	Channel Limits (MHz)		VisionCarrier (MHz)	SoundCarrier (MHz)
	Lower	Upper		
1	47	54	48.25	53.75
2	118	125	119.25	124.75
3	174	181	175.25	180.75
4	190	197	191.25	196.75
5	206	213	207.25	212.75
6	222	229	223.25	228.75
7	230	237	231.25	236.75
8	246	253	247.25	252.75
9	262	269	263.25	268.75
10	286	293	287.25	292.75
11	310	318	311.25	316.75
12	326	334	327.25	332.75
13	342	350	343.25	348.75
14	358	366	359.25	364.75
15	374	382	375.25	380.75
16	390	398	391.25	396.75
17	406	414	407.25	412.75
18	422	430	423.25	428.75
19	438	436	439.25	444.75
20	446	454	447.25	452.75
21	462	470	463.25	468.75
22	478	486	479.25	484.75
23	494	502	495.25	500.75
24	510	518	511.25	516.75
25	526	534	527.25	532.75
26	542	550	543.25	548.75
27	566	574	567.25	572.75
28	582	590	583.25	588.75

Channel	Channel Limits (MHz)		VisionCarrier (MHz)	SoundCarrier (MHz)
29	598	606	599.25	604.75
30	662	670	663.25	668.75
31	678	686	679.25	684.75
32	694	702	695.25	700.75
33	710	718	711.25	716.75
34	726	734	727.25	732.75
35	742	750	743.25	748.75
36	758	766	759.25	764.75
37	774	782	775.25	780.75
38	790	798	791.25	796.75
39	806	814	807.25	812.75
40	822	830	823.25	828.75
41	838	846	839.25	844.75
42	854	862	855.25	860.75

PAL-D/K (8 MHz)

Channel	Channel Limits (MHz)	Vision Carrier (MHz)	Sound Carrier (MHz)
DS-1	48.5~56.5	49.75	56.25
DS-2	56.5~64.5	57.75	64.25
DS-3	64.5~72.5	65.75	72.25
DS-4	76~84	77.25	83.75
DS-5	84~92	85.25	91.75
Z-1	111~119	112.25	118.75
Z-2	119~127	120.25	126.75
Z-3	127~135	128.25	234.75
Z-4	135~143	136.25	142.75
Z-5	143~151	144.25	150.75
Z-6	151~159	152.25	158.75
Z-7	159~167	160.25	166.75

Appendix A: Channel Identification Plans

PAL Channels

Channel	Channel Limits (MHz)	Vision Carrier (MHz)	Sound Carrier (MHz)
DS-6	167~175	168.25	174.25
DS-7	175~183	176.25	182.75
DS-8	183~191	184.25	190.75
DS-9	191~199	192.25	198.75
DS-10	199~207	200.25	206.75
DS-11	207~215	208.25	214.75
DS-12	215~223	216.25	222.75
Z-8	223~231	224.25	230.75
Z-9	231~239	232.25	238.75
Z-10	239~247	240.25	246.75
Z-11	247~255	248.25	254.75
Z-12	255~263	256.25	262.75
Z-13	263~271	264.25	270.75
Z-14	271~279	272.25	278.75
Z-15	279~287	280.25	286.75
Z-16	287~295	288.25	294.75
Z-17	295~303	296.25	302.75
Z-18	303~311	304.25	310.75
Z-19	311~319	312.25	318.75
Z-20	319~327	320.25	326.75
Z-21	327~335	328.25	334.75
Z-22	335~343	336.25	342.75
Z-23	343~351	344.25	350.75
Z-24	351~359	352.25	358.75
Z-25	359~367	360.25	366.75
Z-26	367~375	368.25	374.75
Z-27	375~383	376.25	382.75
Z-28	383~391	384.25	390.75
Z-29	391~399	392.25	398.75
Z-30	399~407	400.25	406.75

Channel	Channel Limits (MHz)	Vision Carrier (MHz)	Sound Carrier (MHz)
Z-31	407~415	408.25	414.75
Z-32	415~423	416.25	422.75
Z-33	423~431	424.25	430.75
Z-34	431~439	432.25	438.75
Z-35	439~447	440.25	446.75
Z-36	447~455	448.25	454.75
Z-37	455~463	456.25	462.75
Z-38	566~574	567.25	573.75
Z-39	574~582	575.25	581.75
Z-40	582~590	583.25	589.75
Z-41	590~598	591.25	597.75
Z-42	598~606	599.25	605.75
DS-13	470~478	471.25	477.75
DS-14	478~486	479.25	485.75
DS-15	486~494	487.25	493.75
DS-16	494~502	495.25	501.75
DS-17	502~510	503.25	509.75
DS-18	510~518	511.25	517.75
DS-19	518~526	519.25	525.75
DS-20	526~534	527.25	533.75
DS-21	534~542	535.25	541.75
DS-22	542~550	543.25	549.75
DS-23	550~558	551.25	557.75
DS-24	558~566	559.25	565.75
DS-25	606~614	607.25	613.75
DS-26	614~622	615.25	621.75
DS-27	622~630	623.25	629.75
DS-28	630~638	631.25	637.75
DS-29	638~646	638.25	645.75
DS-30	646~654	647.25	653.75

Appendix A: Channel Identification Plans

PAL Channels

Channel	Channel Limits (MHz)	Vision Carrier (MHz)	Sound Carrier (MHz)
DS-31	654-662	655.25	661.75
DS-32	662-670	663.25	669.75
DS-33	670-678	671.25	677.75
DS-34	678-686	679.25	685.75
DS-35	686-694	687.25	693.75
DS-36	694-702	695.25	701.75
DS-37	702-710	703.25	709.75
DS-38	710-718	711.25	717.75
DS-39	718-726	719.25	725.75
DS-40	726-734	727.25	733.75
DS-41	734-742	735.25	741.75
DS-42	742-750	743.25	749.75
DS-43	750-758	751.25	757.75
DS-44	758-766	759.25	765.75
DS-45	766-774	767.25	773.75
DS-46	774-782	775.25	781.75
DS-47	782-790	783.25	789.75
DS-48	790-798	791.25	797.75
DS-49	798-806	799.25	805.75
DS-50	806-814	807.25	813.75
DS-51	814-822	815.25	821.75
DS-52	822-830	823.25	829.75
DS-53	830-838	831.25	837.75
DS-54	838-846	839.25	845.75
DS-55	846-854	847.25	853.75
DS-56	854-862	855.25	861.75
DS-57	862-870	863.25	869.75
DS-58	870-878	871.25	877.75
DS-59	878-886	879.25	885.75
DS-60	886-894	887.25	893.75

Channel	Channel Limits (MHz)	Vision Carrier (MHz)	Sound Carrier (MHz)
DS-61	894~902	895.25	901.75
DS-62	902~910	903.25	909.75
DS-63	910~918	911.25	917.75
DS-64	918~926	919.25	925.75
DS-65	926~934	927.25	933.75
DS-66	934~942	935.25	941.75
DS-67	942~950	943.25	949.75
DS-68	950~958	951.25	957.75

Appendix A: Channel Identification Plans
PAL Channels